

FEATURES

Passive: no dc bias required
Conversion loss: 9 dB typical
Input IP3: 19 dBm typical
LO to RF isolation: 48 dB typical
Wide IF frequency range: dc to 8 GHz
12-terminal, 3 mm × 3 mm, RoHS compliant LCC package

APPLICATIONS

Microwave and very small aperture terminal (VSAT) radios
Test equipment
Point to point radios
Military electronic warfare (EW); electronic countermeasure (ECM); and command, control, communications and intelligence (C3I)

GENERAL DESCRIPTION

The HMC292ALC3B is a general-purpose, double balanced, monolithic microwave integrated circuit (MMIC), mixer housed in a leadless Pb-free, RoHS compliant LCC package, that can be used as an upconverter or downconverter in the 14 GHz to 30 GHz frequency range. The HMC292ALC3B is ideally suited for applications where small size, no dc bias, and consistent IC performance are required. This mixer can operate over a wide

FUNCTIONAL BLOCK DIAGRAM

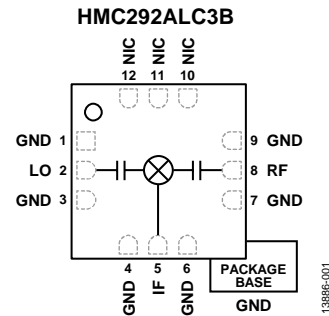

Figure 1.

local oscillator (LO) drive level of 9 dBm to 15 dBm. It performs equally well as a biphas modulator or demodulator. The HMC292ALC3B eliminates the need for wire bonding, allowing use of surface-mount manufacturing techniques.

TABLE OF CONTENTS

Features	1	Downconverter Performance	6
Applications.....	1	Upconverter Performance.....	8
Functional Block Diagram	1	Isolation and Return Loss	9
General Description	1	IF Bandwidth—Downconverter.....	11
Revision History	2	Spurious and Harmonics Performance	12
Specifications.....	3	Theory of Operation	13
Absolute Maximum Ratings.....	4	Applications Information	14
Thermal Resistance	4	Typical Application Circuit.....	14
ESD Caution.....	4	Evaluation PCB Information	14
Pin Configuration and Function Descriptions.....	5	Outline Dimensions	15
Interface Schematics.....	5	Ordering Guide	15
Typical Performance Characteristics	6		

REVISION HISTORY

2/2018—Rev. 0 to Rev. A

Changes to Figure 9.....	6
Changes to Ordering Guide	15

8/2017—Revision 0: Initial Version

SPECIFICATIONS

Ambient temperature (T_A) = 25°C, intermediate frequency (IF) = 1 GHz, radio frequency (RF) = -10 dBm, LO = 13 dBm, upper sideband. All measurements performed as a downconverter, unless otherwise noted, on the evaluation printed circuit board (PCB).

Table 1.

Parameter	Min	Typ	Max	Unit
FREQUENCY RANGE				
RF Pin	14		30	GHz
IF Pin	DC		8	GHz
LO Pin	14		30	GHz
LO DRIVE LEVEL	9	13	15	dBm
RF PERFORMANCE				
Downconverter				
Conversion Loss		9	12.5	dB
Single Sideband (SSB) Noise Figure (NF)		10.5		dB
Input Third Order Intercept (IP3)	15	19		dBm
Input 1 dB Compression Point (P1dB)		12		dBm
Input Second Order Intercept (IP2)		50		dBm
Isolation				
RF to IF	22	38		dB
LO to RF		48		dB
LO to IF	28	40		dB
Upconverter				
Conversion Loss		9		dB
IP3		20		dBm
P1dB		9		dBm

ABSOLUTE MAXIMUM RATINGS

Table 2.

Parameter	Rating
RF Input Power	18 dBm
LO Input Power	27 dBm
IF Input Power	18 dBm
IF Source and Sink Current	±3 mA
Reflow Temperature	260°C
Maximum Junction Temperature	175°C
Continuous Power Dissipation, P_{DISS} ($T_A = 85^\circ\text{C}$, Derate 5.12 mW/°C Above 85°C)	460 mW
Operating Temperature Range	-40 to +85°C
Storage Temperature Range	-65 to +150°C
Lead Temperature Range	-65 to +150°C
Electrostatic Discharge (ESD) Sensitivity	
Human Body Model (HBM)	500 V
Field Induced Charged Device Model (FICDM)	500 V

Stresses at or above those listed under Absolute Maximum Ratings may cause permanent damage to the product. This is a stress rating only; functional operation of the product at these or any other conditions above those indicated in the operational section of this specification is not implied. Operation beyond the maximum operating conditions for extended periods may affect product reliability.

THERMAL RESISTANCE

Thermal performance is directly linked to printed circuit board (PCB) design and operating environment. Careful attention to PCB thermal design is required.

θ_{JA} is the natural convection junction to ambient thermal resistance measured in a one cubic foot sealed enclosure. θ_{JC} is the junction to case thermal resistance.

Table 3. Thermal Resistance

Package Type	θ_{JA}	θ_{JC}	Unit
E-12-4 ¹	120	195	°C/W

¹ See JEDEC standard JESD51-2 for additional information on optimizing the thermal impedance (PCB with 3 × 3 vias).

ESD CAUTION



ESD (electrostatic discharge) sensitive device. Charged devices and circuit boards can discharge without detection. Although this product features patented or proprietary protection circuitry, damage may occur on devices subjected to high energy ESD. Therefore, proper ESD precautions should be taken to avoid performance degradation or loss of functionality.

PIN CONFIGURATION AND FUNCTION DESCRIPTIONS

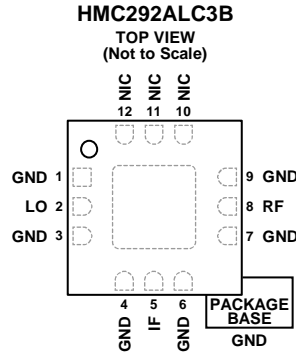

- NOTES**
1. NOT INTERNALLY CONNECTED. THESE PINS CAN BE CONNECTED TO RF/DC GROUND. PERFORMANCE IS NOT AFFECTED.
 2. EXPOSED PAD. THE EXPOSED PAD MUST BE CONNECTED TO RF/DC GROUND.

13886-002

Figure 2. Pin Configuration

Table 4. Pin Function Descriptions

Pin No.	Mnemonic	Description
1, 3, 4, 6, 7, 9	GND	Ground. These pins and package bottom must be connect to RF/dc ground. See Figure 3 for the interface schematic.
2	LO	Local Oscillator Port. This pin is ac-coupled and matched to 50 Ω. See Figure 4 for the interface schematic.
5	IF	Intermediate Frequency Port. This pin is dc-coupled. For applications, not requiring operation to dc, dc block this port externally using a series capacitor of a value chosen to pass the necessary IF frequency range. For operation to dc, this pin must not source or sink more than 3 mA of current or die malfunction and possible die failure can result. See Figure 5 for the interface schematic.
8	RF	Radio Frequency Port. This pin is ac-coupled and matched to 50 Ω. See Figure 6 for the interface schematic.
10, 11, 12	NIC EPAD	Not Internally Connected. These pins can be connected to RF/dc ground. Performance is not affected. Exposed Pad. The exposed pad must be connected to RF/dc ground.

INTERFACE SCHEMATICS



Figure 3. GND Interface Schematic

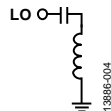

Figure 4. LO Interface Schematic

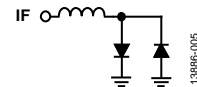

Figure 5. IF Interface Schematic

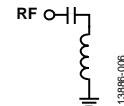

Figure 6. RF Interface Schematic

TYPICAL PERFORMANCE CHARACTERISTICS

DOWNCONVERTER PERFORMANCE

Downconverter performance at IF = 1 GHz, upper sideband (low-side LO).

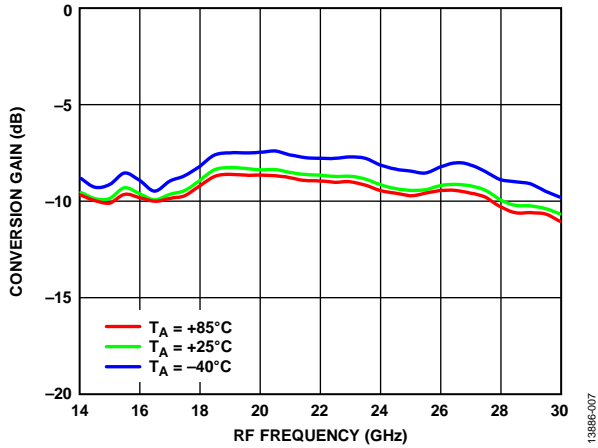

Figure 7. Conversion Gain vs. RF Frequency at Various Temperatures, LO = 13 dBm

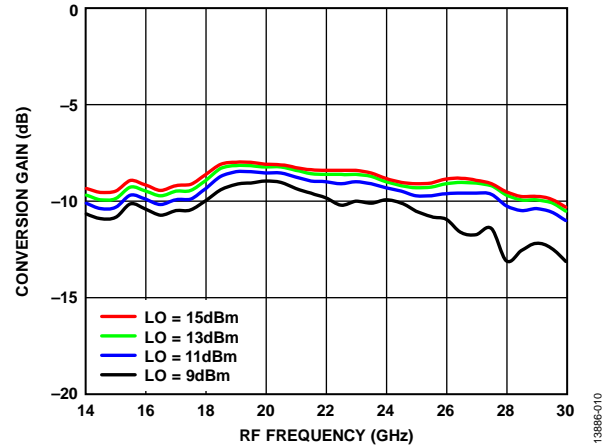

Figure 10. Conversion Gain vs. RF Frequency at Various LO Power Levels, TA = 25°C

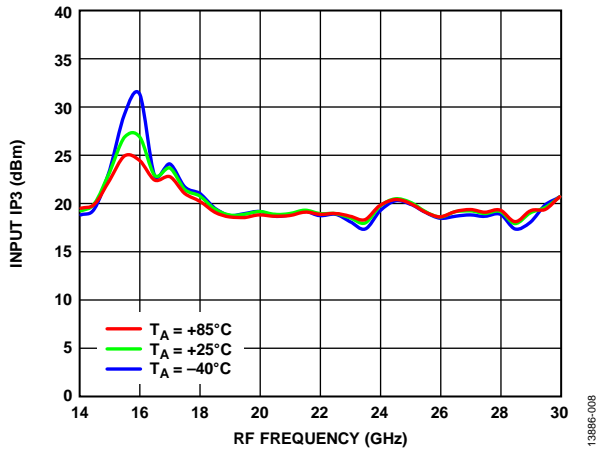

Figure 8. Input IP3 vs. RF Frequency at Various Temperatures, LO = 13 dBm

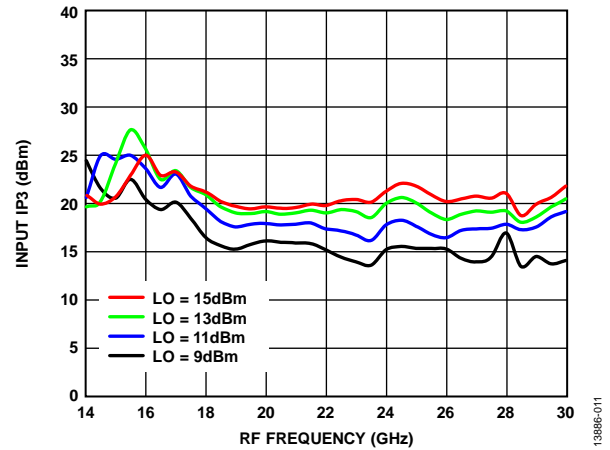

Figure 11. Input IP3 vs. RF Frequency at Various LO Power Levels, TA = 25°C

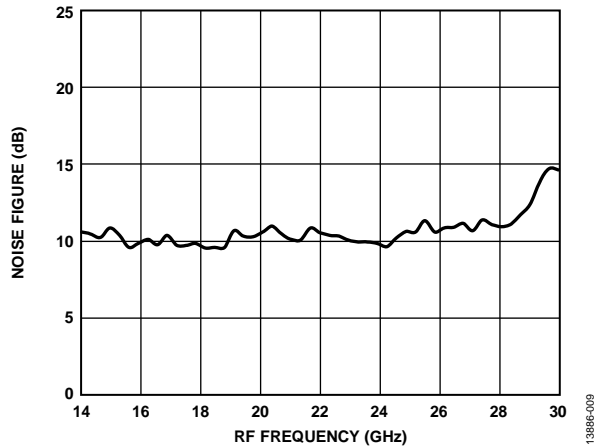

Figure 9. Noise Figure vs. RF Frequency at TA = 25°C, LO = 13 dBm

Downconverter P1dB and IP2

IF = 1 GHz, upper sideband (low-side LO).

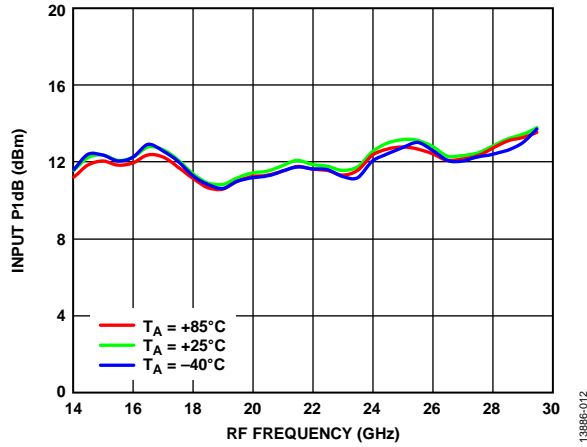

Figure 12. Input P1dB vs. RF Frequency at Various Temperatures, LO = 13 dBm

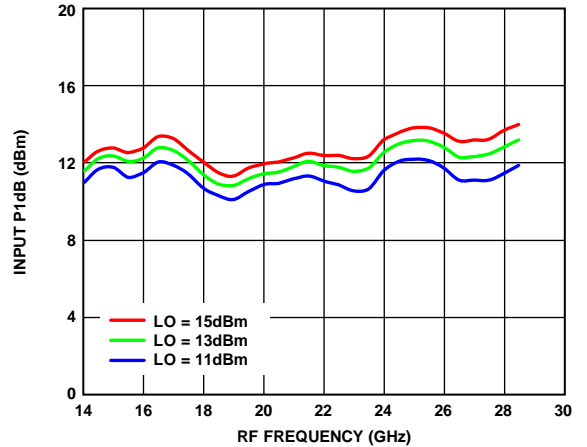

Figure 14. Input P1dB vs. RF Frequency at Various LO Power Levels, TA = 25°C

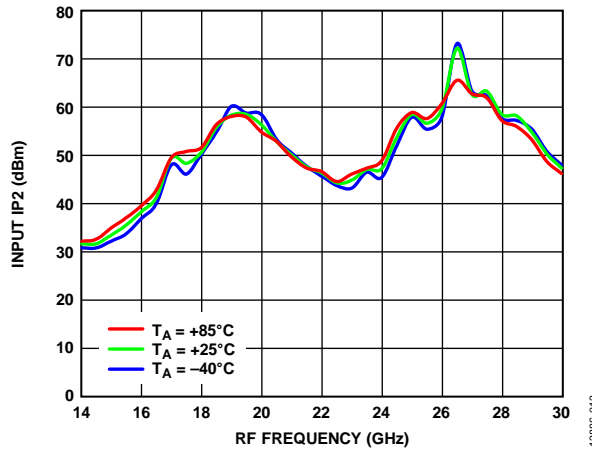

Figure 13. Input IP2 vs. RF Frequency at Various Temperatures, LO = 13 dBm

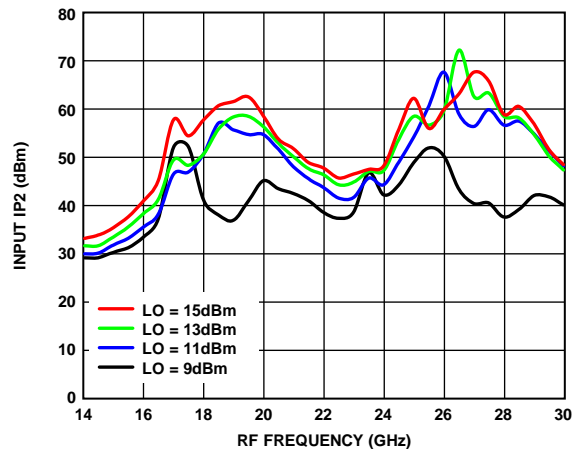

Figure 15. Input IP2 vs. RF Frequency at Various LO Power Levels, TA = 25°C

UPCONVERTER PERFORMANCE

Upconverter performance at input intermediate frequency (IF_{IN}) = 1 GHz, upper sideband (low-side LO).

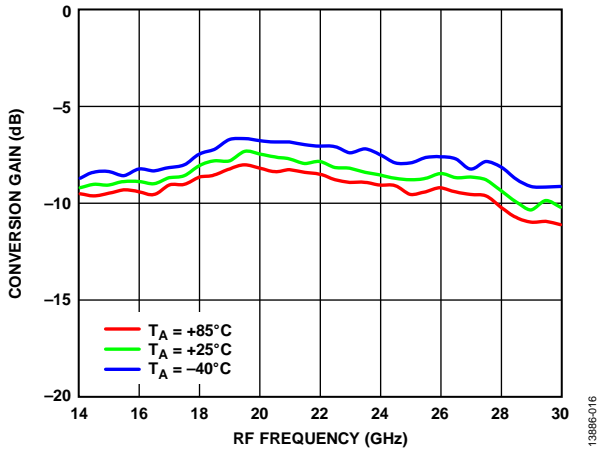

Figure 16. Conversion Gain vs. RF Frequency at Various Temperatures, LO = 13 dBm

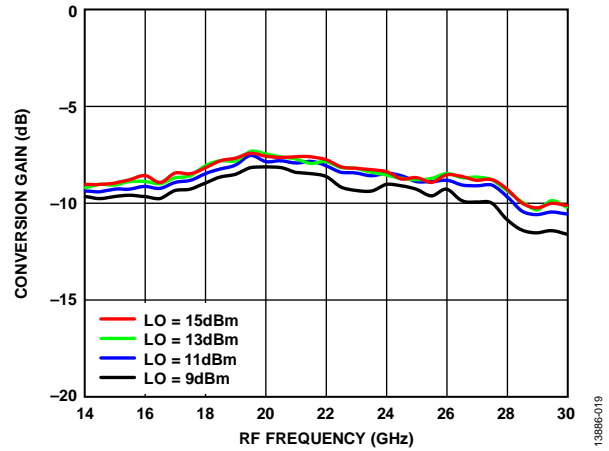

Figure 19. Conversion Gain vs. RF Frequency at Various LO Power Levels, $T_A = 25^\circ\text{C}$

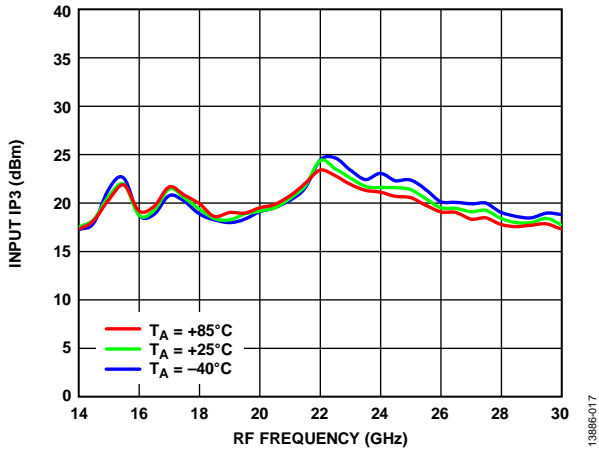

Figure 17. Input IP3 vs. RF Frequency at Various Temperatures, LO = 13 dBm

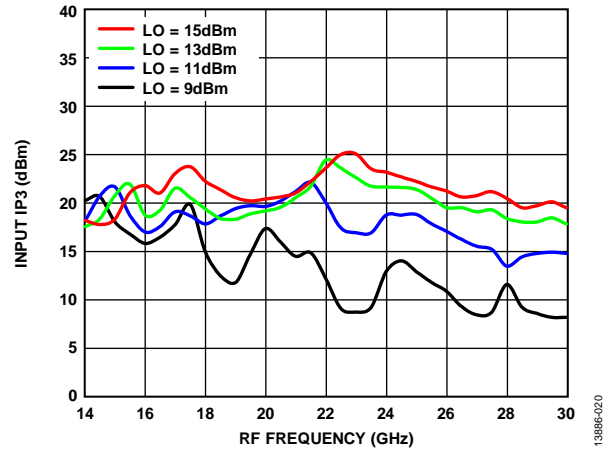

Figure 20. Input IP3 vs. RF Frequency at Various LO Power Levels, $T_A = 25^\circ\text{C}$

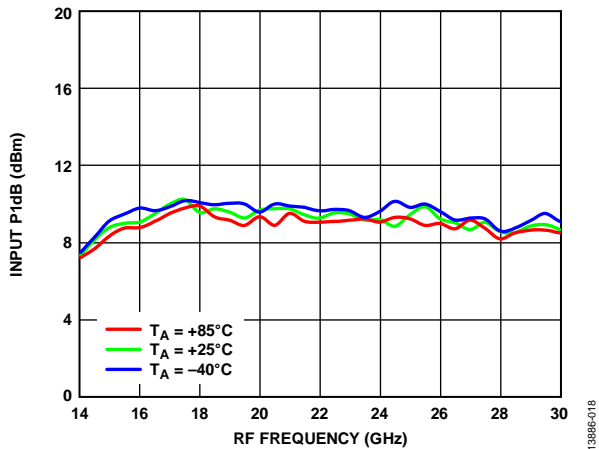

Figure 18. Input P1dB vs. RF Frequency at Various Temperatures, LO = 13 dBm

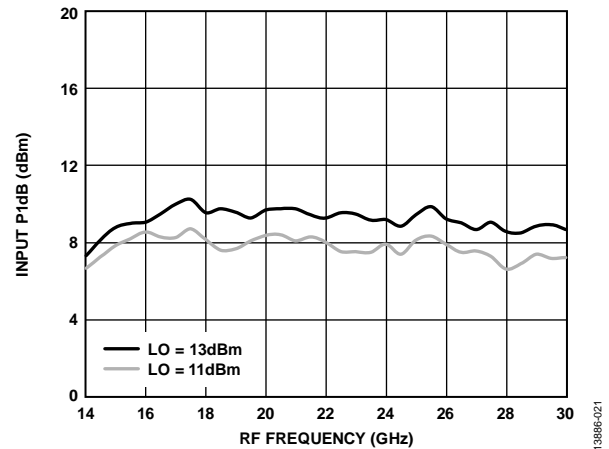

Figure 21. Input P1dB vs. RF Frequency at Various LO Power Levels, $T_A = 25^\circ\text{C}$

ISOLATION AND RETURN LOSS

Downconverter performance at IF = 1 GHz, upper sideband (low-side LO).

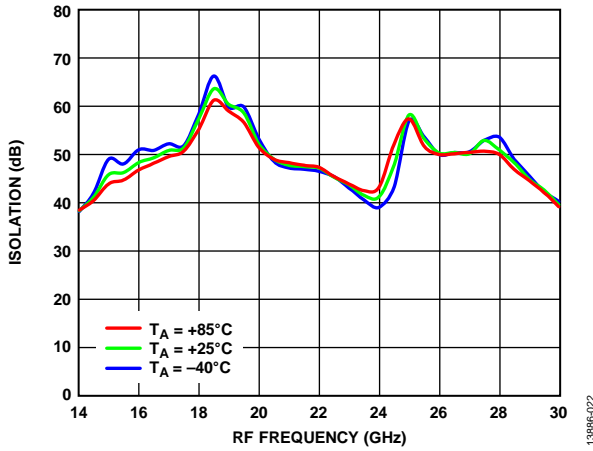

Figure 22. LO to RF Isolation vs. RF Frequency at Various Temperatures, LO = 13 dBm

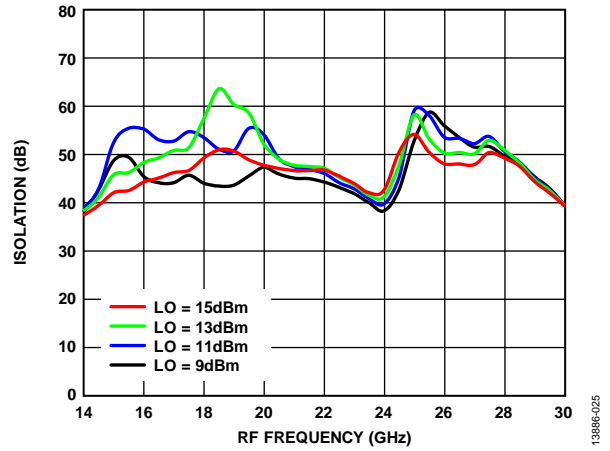

Figure 25. LO to RF Isolation vs. RF Frequency at Various LO Power Levels, $T_A = 25^\circ\text{C}$

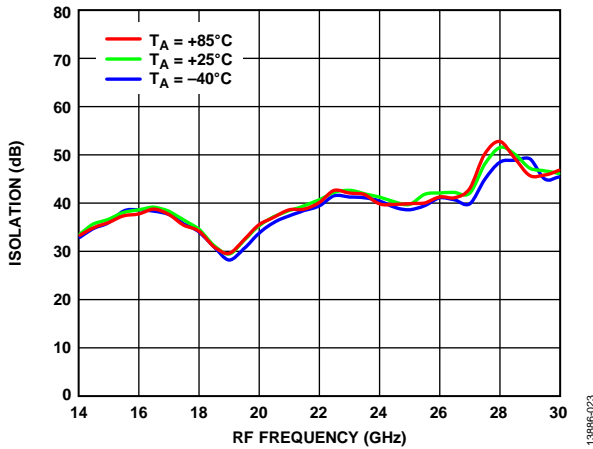

Figure 23. LO to IF Isolation vs. RF Frequency at Various Temperatures, LO = 13 dBm

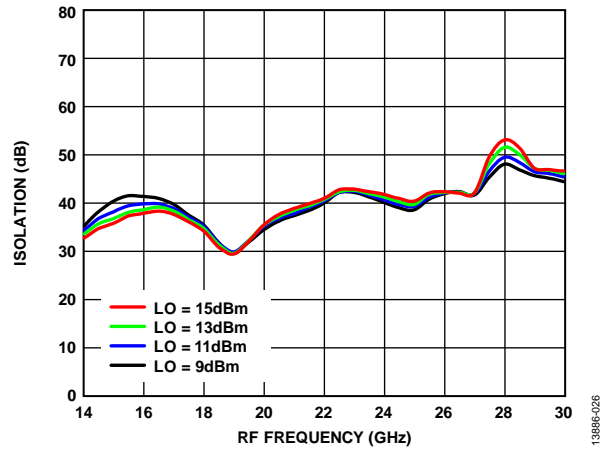

Figure 26. LO to IF Isolation vs. RF Frequency at Various LO Power Levels, $T_A = 25^\circ\text{C}$

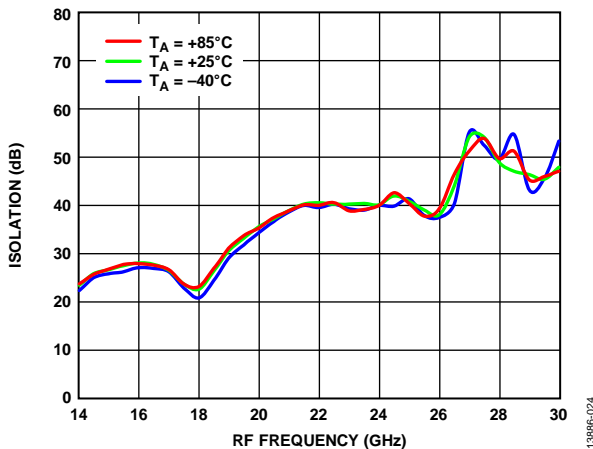

Figure 24. RF to IF Isolation vs. RF Frequency at Various Temperatures, LO = 13 dBm

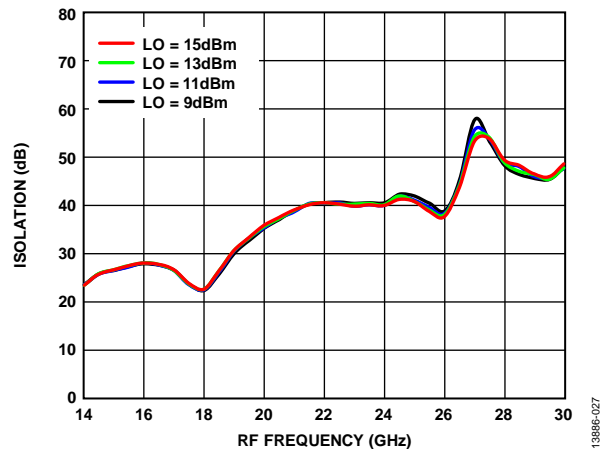

Figure 27. RF to IF Isolation vs. RF Frequency at Various LO Power Levels, $T_A = 25^\circ\text{C}$

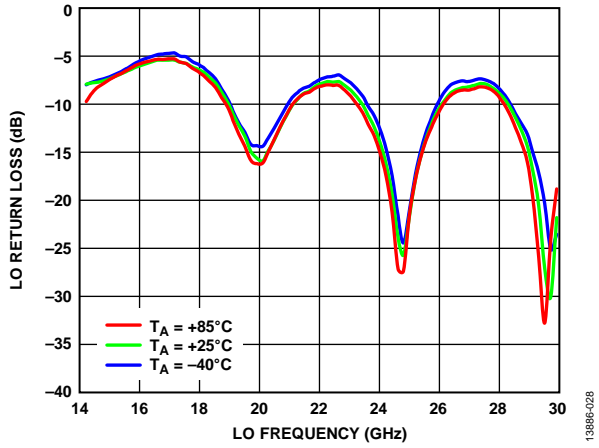

Figure 28. LO Return Loss vs. LO Frequency at Various Temperatures, LO = 13 dBm

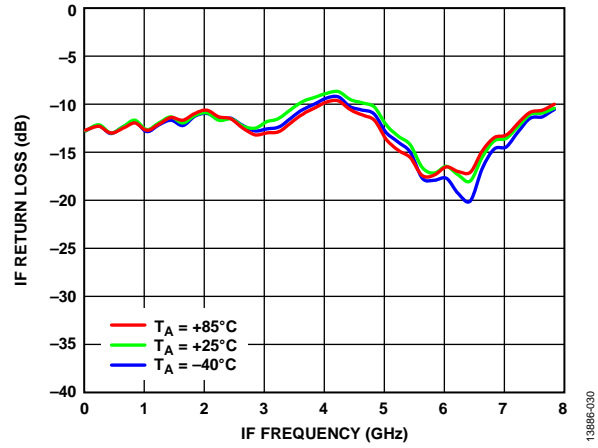

Figure 30. IF Return Loss vs. IF Frequency at Various Temperatures, LO = 25 GHz, 13 dBm

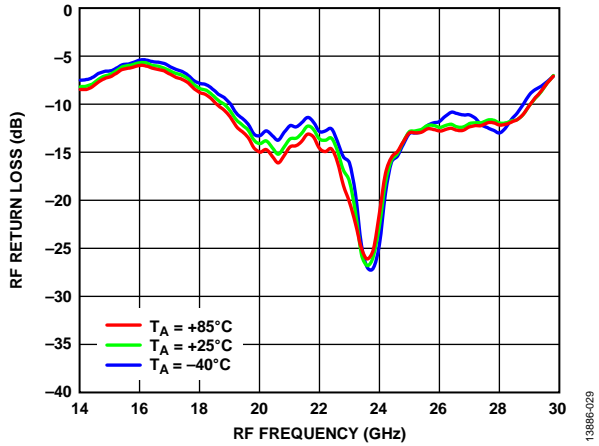

Figure 29. RF Return Loss vs. RF Frequency at Various Temperatures, LO = 25 GHz, 13 dBm

IF BANDWIDTH—DOWNCONVERTER

Upper sideband, LO frequency = 20 GHz.

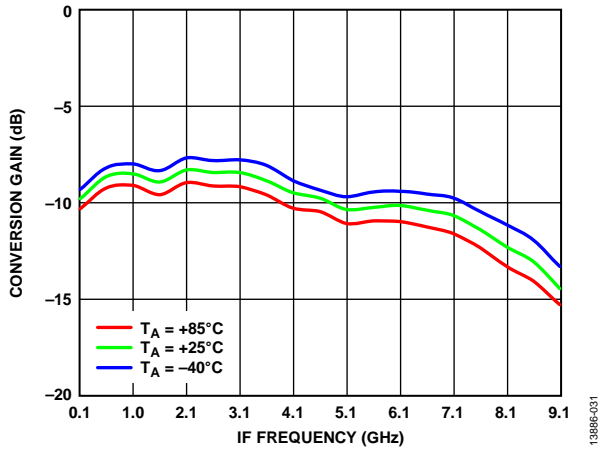

Figure 31. Conversion Gain vs. IF Frequency at Various Temperatures, LO = 13 dBm

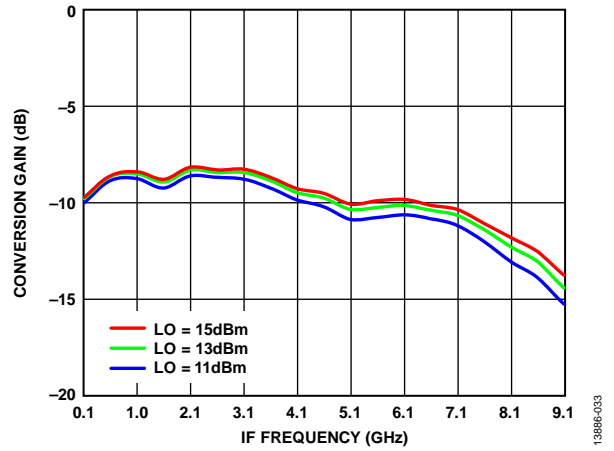

Figure 33. Conversion Gain vs. IF Frequency at Various LO Power Levels, $T_A = 25^\circ\text{C}$

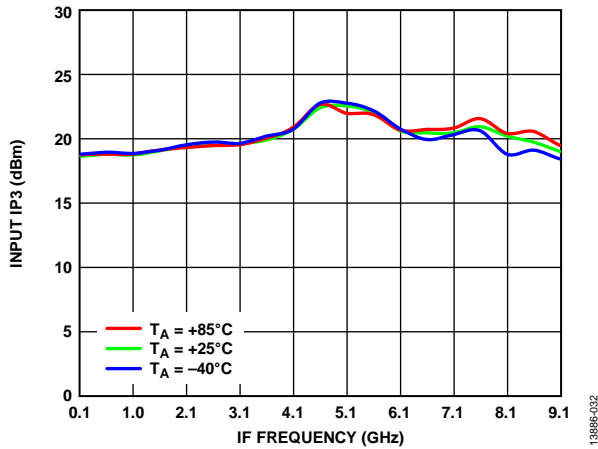

Figure 32. Input IP3 vs. IF Frequency at Various Temperatures, LO = 13 dBm

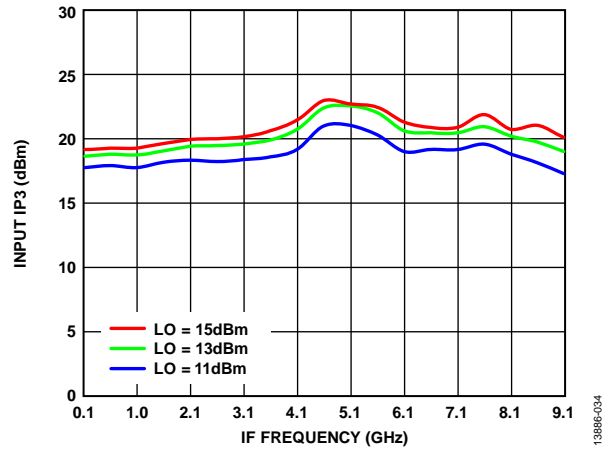

Figure 34. Input IP3 vs. IF Frequency at Various LO Power Levels, $T_A = 25^\circ\text{C}$

SPURIOUS AND HARMONICS PERFORMANCE

Mixer spurious products are measured in dBc from the IF output power level. N/A means not applicable.

Downconverter $M \times N$ Spurious Outputs

Spur values are $(M \times RF) - (N \times LO)$.

RF = 22 GHz at -10 dBm, LO = 21 GHz at 13 dBm.

		N × LO				
		0	1	2	3	4
M × RF	0	N/A	13	39	N/A	N/A
	1	32	0	51	70	N/A
	2	58	74	62	73	71
	3	N/A	N/A	74	73	77
	4	N/A	N/A	N/A	73	78

Upconverter $M \times N$ Spurious Outputs

Spur values are $(M \times IF_{IN}) - (N \times LO)$.

$IF_{IN} = 1$ GHz at -10 dBm, LO = 21 GHz at 13 dBm.

		N × LO				
		0	1	2	3	4
M × IF_{IN}	0	N/A	15	NA	N/A	N/A
	1	23	0	>90	N/A	N/A
	2	57	40	>90	N/A	N/A
	3	80	65	76	N/A	N/A
	4	94	87	75	N/A	N/A

THEORY OF OPERATION

The HMC292ALC3B is a general-purpose, double balanced mixer that can be used as an upconverter or a downconverter from 14 GHz to 30 GHz.

When used as a downconverter, the HMC292ALC3B downconverts RF between 14 GHz and 30 GHz to IF between dc and 8 GHz.

When used as an upconverter, the mixer upconverts intermediate frequencies between dc and 8 GHz to radio frequencies between 14 GHz and 30 GHz.

APPLICATIONS INFORMATION

TYPICAL APPLICATION CIRCUIT

Figure 35 shows the typical application circuit for the HMC292ALC3B. The HMC292ALC3B is a passive device and does not require any external components. The LO and RF pins are internally ac-coupled. The IF pin is internally dc-coupled. Use an external series capacitor when IF operation is not required. Choose a value that stays within the necessary IF frequency range. When IF operation to dc is required, do not exceed the IF source and sink current rating specified in the Absolute Maximum Ratings section.

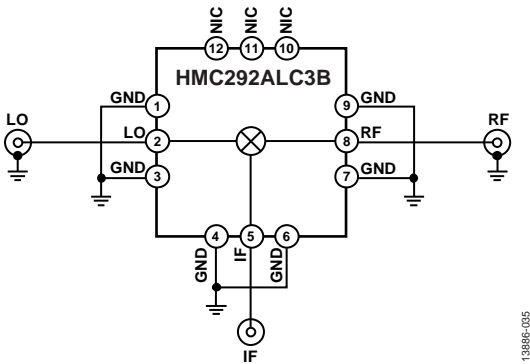

Figure 35. Typical Application Circuit

EVALUATION PCB INFORMATION

Use RF circuit design techniques for the circuit board used in the application. Ensure that signal lines have 50 Ω impedance, and connect the package ground leads and the exposed pad directly to the ground plane (see Figure 36). Use a sufficient number of via holes to connect the top and bottom ground planes. The evaluation circuit board shown in Figure 36 is available from Analog Devices, Inc., upon request.

Table 5. List of Materials for Evaluation PCB

EV1HMC292ALC3B

Item	Description
J1, J2	SRI 2.92 mm connector
J3	Johnson SMA connector
U1	HMC292ALC3B
PCB ¹	117611-7 evaluation board

¹ 117611-7 is the raw bare PCB identifier. Reference the EV1HMC292ALC3B device when ordering the complete evaluation PCB.

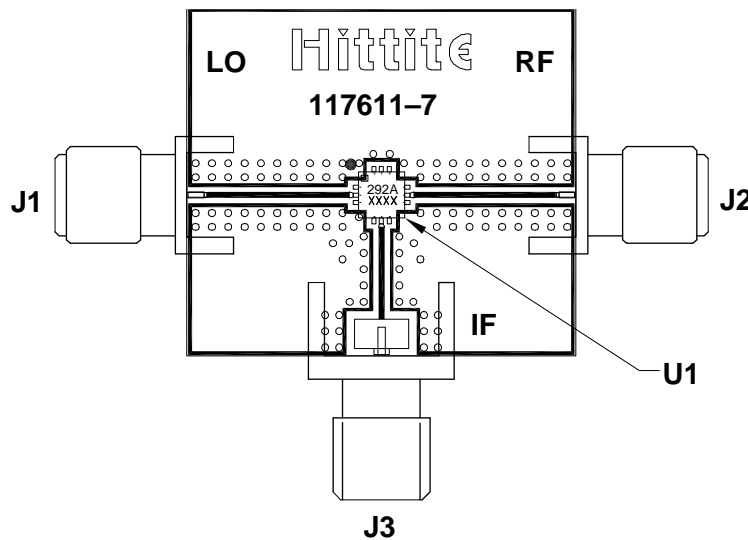

Figure 36. Evaluation PCB Top Layer

OUTLINE DIMENSIONS

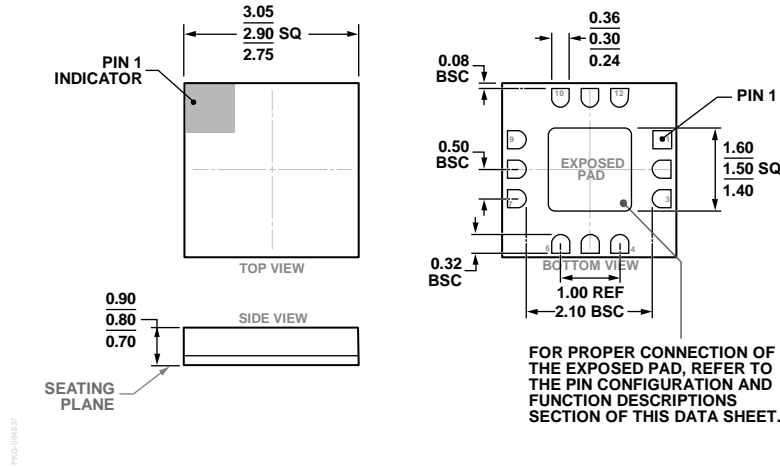

Figure 37. 12-Terminal Ceramic Leadless Chip Carrier (LCC)
(E-12-4)
Dimensions shown in millimeters

ORDERING GUIDE

Model ¹	Temperature Range	MSL Rating ²	Package Description	Package Option
HMC292ALC3B	-40°C to +85°C	MSL3	12-Terminal Ceramic LCC	E-12-4
HMC292ALC3BTR	-40°C to +85°C	MSL3	12-Terminal Ceramic LCC	E-12-4
HMC292ALC3BTR-R5	-40°C to +85°C	MSL3	12-Terminal Ceramic LCC	E-12-4
EV1HMC292ALC3B			Evaluation PCB Assembly	

¹ The HMC292ALC3B, HMC292ALC3BTR, and HMC292ALC3B-R5 are RoHS Compliant Parts.

² See Table 2 for the peak reflow temperature.