

Features:

- Higher Sensitivity Version of the MX8681
- Single 5 Volt Power Supply
- Externally Configurable ±10A Bi-Direction Current Sense per Turn
- 12-Bit Serial Digital Output
- Full Scale Magnetic Flux Intensity of ±100 Gauss
- 2K Conversions/Second
- Microcontroller Compatible
- Standard 3 Wire Serial Interface plus Chip Select
- In System Calibration: OTP Full Scale Trim via the Serial I/O Port
- Programmable Digital Filter Time Constant
- 4mm x 4mm 8 Lead DFN package RoHS Compliant

Applications:

- Load Detection and Management
- Motor Control
- Power Supplies

General Description

The MX8682 is a 12 Bit Digital Output Magnetic Flux Sensor. The device is a complete sampled data subsystem that converts a magnetic flux intensity of ±100 Gauss full scale into a 12-bit digital output word. The sensor operates as a slave on the serial interface with TTL-level compatible inputs SDI (serial data input), SCK (serial clock), and CS* (chip select, active low). Terminal SDO is the tri-state serial data output.

An adjustable exponentially weighted moving average digital filter is included that is capable of improving the signal to noise ratio while reducing the signal bandwidth. The full scale trim and/or the digital filter time constant are controllable through the serial I/O interface and are one-time programmable through the serial interface (once programmed, the values are loaded at every power-on).

The MX8682 can be mounted onto a PCB or incorporated into a magnetic assembly and then calibrated in-system through the serial interface. The operating voltage range is 4.5V to 5.5V.

Ordering Information

Part No.	Description	Qty
MX8682R	DFN-8 Tube	91
MX8682RTR	DFN-8 Tape & Reel	2500

Functional Block Diagram Typical

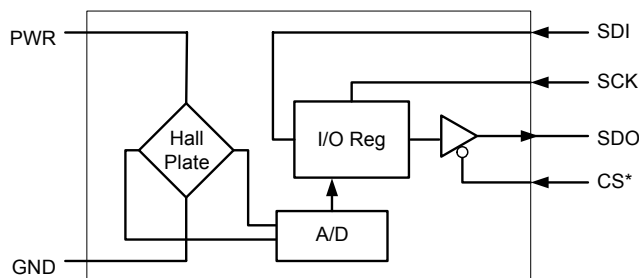

Application Circuit

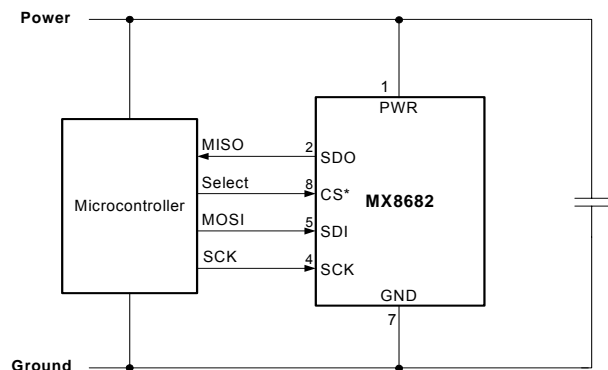

Absolute Maximum Ratings $T_A = +25^\circ\text{C}$ unless otherwise noted

Parameter	Min	Max	Unit
Voltage (Any Pin to GND)		+7	V
θ_{JA} , DFN-8 Package		30	$^\circ\text{C}/\text{W}$
Operating Temperature Range	-40	+85	$^\circ\text{C}$
Storage Temperature Range	-65	150	$^\circ\text{C}$

ESD Warning

ESD (electrostatic discharge) sensitive device. Although the MX8681 features proprietary ESD protection circuitry, permanent damage may occur on devices subjected to high energy electrostatic discharges. Therefore, proper ESD precautions are recommended to avoid performance degradation or loss of functionality.

Electrical Characteristics

PWR= 5V, $T = +25^\circ\text{C}$

Parameter	Condition	Min	Typ	Max	Unit
Operating Voltage Range (PWR)		4.5		5.5	V
Supply Current (I_{PWR})			3		mA
Average A/D Reading	Zero Magnetic Flux	2040	2048	2056	LSB
Average A/D Reading	50 Gauss, North Pole		3072		LSB
Output Noise	Digital Filter Off		5.5		RMS LSB
SCK pulse period		5			μS
SCK pulse width	high or low	200			nS
CS* pulse period		500			μS
CS* falling to first SCK rising		100			nS
Last SCK falling to CS* rising		50			nS
SCK falling to SDO valid				60	nS
Digital output high		PWR-0.5			V
Digital output low				0.5	
Digital input low		GND		0.8	V
Digital input high		2		PWR	
Digital input current				1	μA

Pin Description

Pin No.	Name	Description
1	PWR	Input Voltage Supply
2	SDO	Serial Data Output
3	NC	No Connect
4	SCK	Serial Clock Input
5	SDI	Serial Data Input
6	NC	No Connect
7	GND	Connect to Ground
8	CS*	Active low chip select for the serial interface. When a logic “high” is on this pin, the MX8682 is tracking the hall input signal.

Detailed Circuit Description

The hall plate senses the magnetic field that is applied normal (perpendicular) to the package surface. The signal from the hall plate is offset-corrected by detecting the difference between a pair of analog samples during the acquisition time. During idle time (CS* high) the MX8682 tracks the first analog sample. Immediately (~10 nS) after the falling edge of CS* the first sample is held. The track mode for the second sample starts nominally 32 μS after the falling edge of CS*. Typically 96 μS after the falling edge of CS* the second sample is held and the resulting analog value is then converted by the A/D. The result of the A/D conversion is loaded into the I/O register at the next falling edge of CS*, in preparation for output on SDO.

The internal acquisition and A/D timing is asynchronous to the SCK serial interface clock. The magnetic field sampling period is controlled externally by the time between consecutive CS* falling edges. For zero magnetic field input the nominal A/D output is 2048 decimal. North pole towards the top surface of the MX8682 increases the A/D output count. Applications that require non-continuous one measurement at a time operation should pulse CS* low twice, reading the data when CS* is low for the second time.

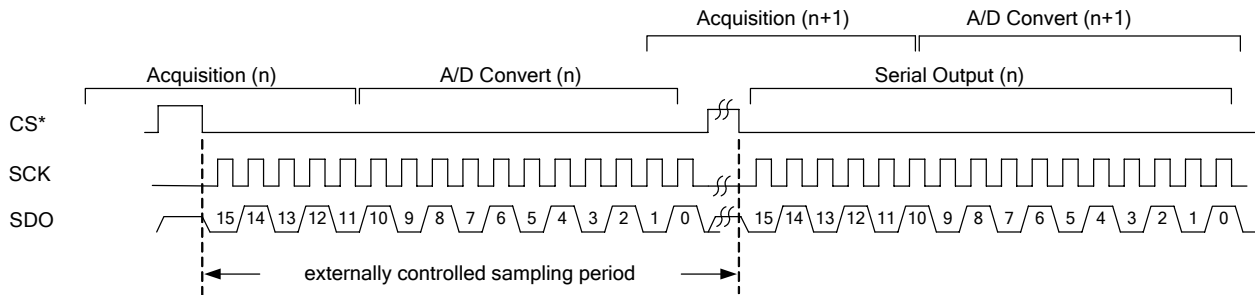

POWER-ON RESET

The MX8682 contains a power-on reset circuit that resets all the internal flip-flops and initializes the internal registers to zero. The MX8682 will reset if the voltage at terminal PWR drops below 3.2V to 3.8V.

SYNCHRONOUS SERIAL I/O

The MX8682 (slave) can communicate with a microcomputer (master) via a three wire plus chip select serial interface. Chip select CS*, serial clock SCK, and serial data input SDI are output from the master controller to the MX8682.

Serial data output SDO is driven by the MX8682 when selected by CS* = 0.

SDO is high impedance when CS* = 1.

SCK and SDI are don't care when CS* = 1.

SDI is captured by the rising edge of SCK.

SDO changes in response to the falling edge of SCK.

Read 12-bit data D[11:0] when SDI = logic 0

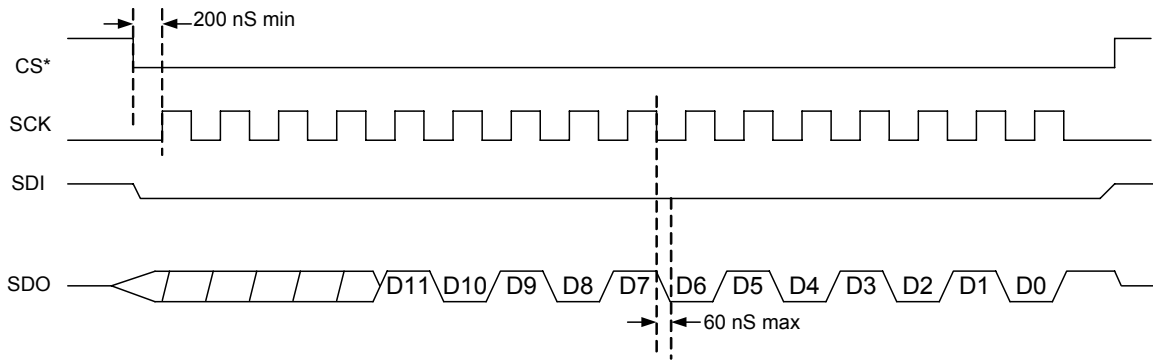

Write command timing: (Bit Field A[2:0], B[5:0], OTP Bit Zp)

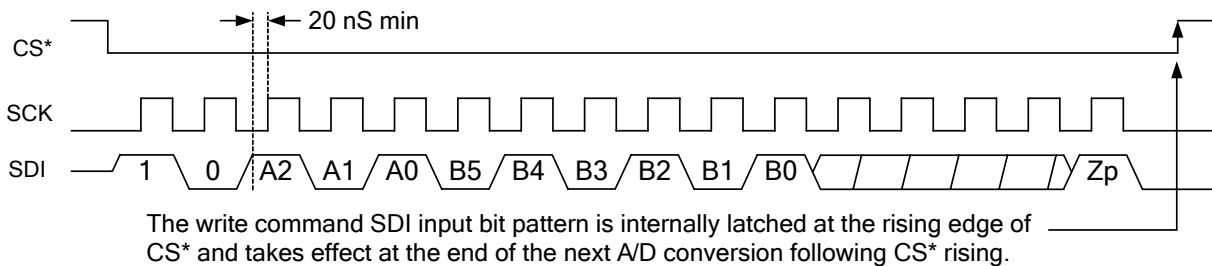

The exponentially weighted moving average digital filter has a transfer function equivalent to a first order low pass filter.

The I/O timing remains exactly the same when the filter is used. No decimation is performed.

Let T = Sample interval (the time from CS* falling edge to CS* falling edge). Then bandwidth = $1/(2\pi T)$.

Also if W = Sample weighting, then the digital output = $W(\text{current sample}) + (1-W)(\text{previous value})$.

At power-on the previous value is initialized to zero. A programmed change in A[2:0] does not reset the previous value. Therefore when using the filter, multiple samples must be taken at power-on or after changing A[2:0] before the filtered output will be correct.

Bit field A[2:0] controls the digital filter operation:

A[2:0]	Time Constant	Sample Weighting
000	No Filter	1
001	T	1/2
010	3T	1/4
011	7T	1/8
100	15T	1/16
101	31T	1/32
110	63T	1/64
111	127T	1/128

Bit field B[5:0] is the full scale adjust.
 Characteristics are 0.8% step size, ±25% total range.

B[5:0] = 000000 is the lowest sensitivity (highest full scale)
 B[5:0] = 111111 is the highest sensitivity

One-Time Programming:

Bit Zp, when logic 1 along with A[2:0] and B[5:0] values, programs those values into the internal non-volatile memory.

Programming a bit to logic 1 is permanent. A bit programmed to logic 1 cannot be made to go back to logic 0.

Always send a write command with Zp = 0 and SDI = 0 immediately after the programming command. The actual programming pulse occurs internally at the falling edge of CS* in the command following the command in which Zp = logic 1.

The write command can be used to preview the trim bits as long as Zp is logic 0.

Examples:

The bit field B[5:0] can be programmed while the A[2:0] bit field is "000", or vice versa. For example the total SDI bit pattern could be 10 000 001100 0000 1. This would permanently set the B[5:0] bit field to 001100 but the filter setting could still be subsequently changed by a different write command, either in preview or programming.

The SDI bit pattern 10 010 010000 0000 0 would set the filter time constant to 3T and the full scale field to 010000 as a preview, without making it permanent (because bit Zp = 0).

If the sample interval T = 1 mS and A[2:0] = 001 then the effective bandwidth would be $1/(2 \times 3.14 \times 1e-3) = 159$ Hz. For this condition, if the steady state output was 2000 counts and a step input was applied that would drive the output to 3000 counts then the digital output response would be 2000, 2500, 2750, 2875, 2937, 2968, 2984, 2992, 2996, 2998, 2999, 2999, 3000.

Cascade Configurations

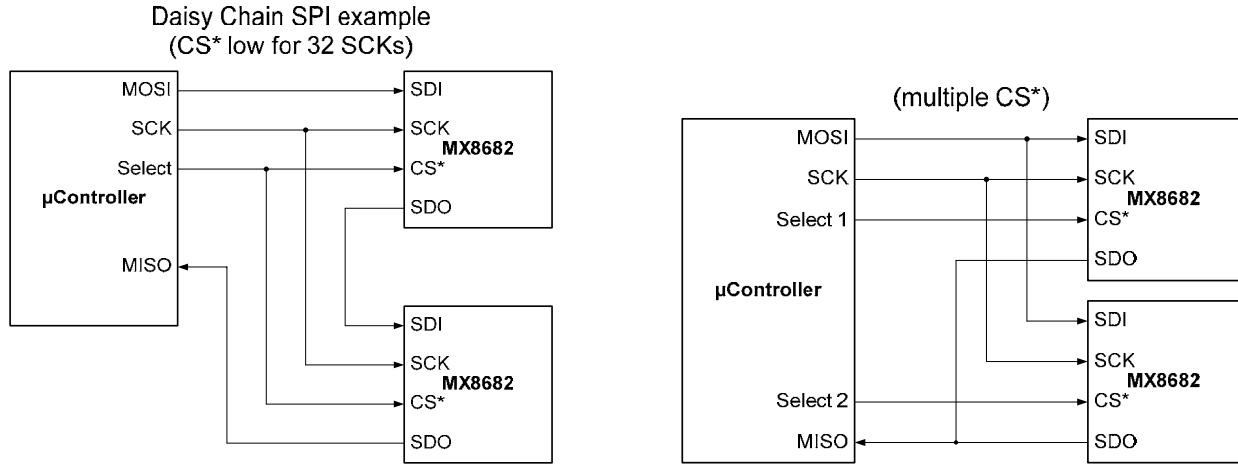

Sensor Location

8 Lead DFN 4x4 mm
(Top View - Drawing not to scale)

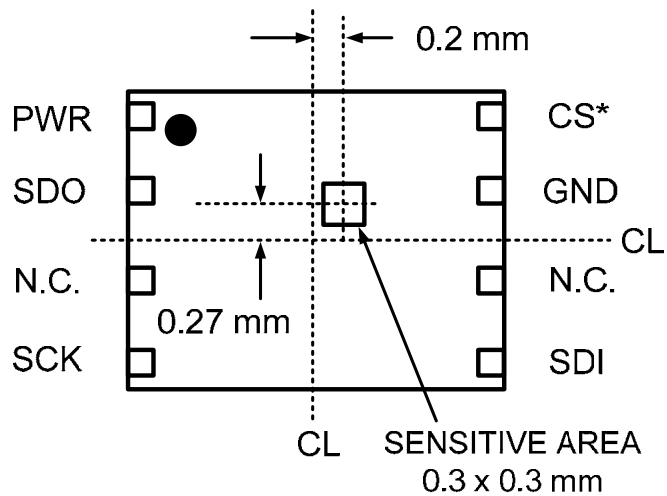

Application Example

This application example illustrates one method of incorporating the MX8682 into a power circuit board design. The double-sided 8oz copper traces carry 10A (5A on the top trace and 5A on the bottom trace) around the center section of the planar E-core. The MX8682 is mounted on a small single layer flex circuit that effectively adds a third layer. The flex also fans out the fine pitch DFN package to a pitch compatible with the power board. The magnetic circuit consists of two ferrite E14 planar cores. The center post of one of the cores is gapped to accommodate the MX8682 package thickness plus the flex circuit thickness. For the 10A full scale application a gap of 47 to 52 mils is appropriate (1.2 to 1.32 mm). The gain trim range of the MX8682 can accommodate even larger gaps if required.

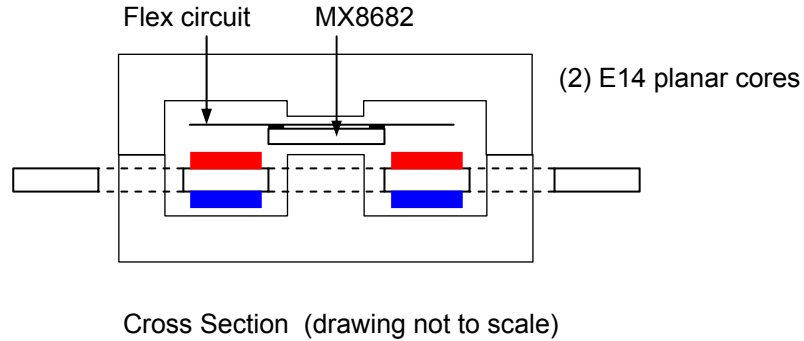

PCB top layer: (scale 1X)

PCB bottom layer: (top view, 1X)

Flex circuit: (component side, 1X)

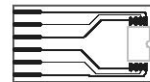
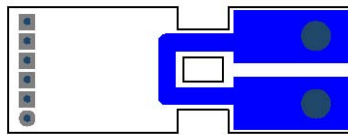
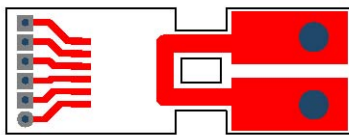

This following example illustrates the MX8682 mounted directly on a 1oz PCB with a copper strap positioned around the Hall element to carry the current being measured.

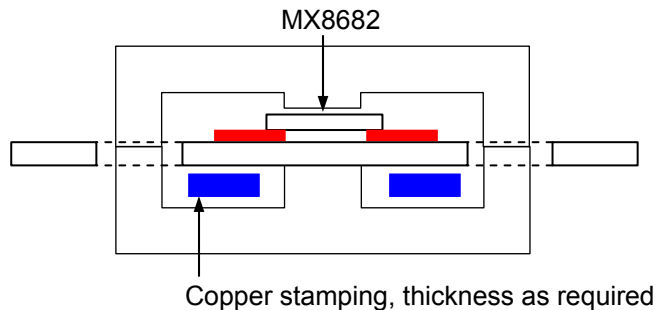

Design alternatives:

The use of an E-I core pair results in a lower profile than E-E however a thinner board must be used. A thinner sensor can be obtained by FCOF (flip chip on flex) packaging of the MX8682 bumped die. The maximum mounting height of the DFN package is 1.1 mm whereas the chip height is about 0.4 mm.

8 Lead DFN

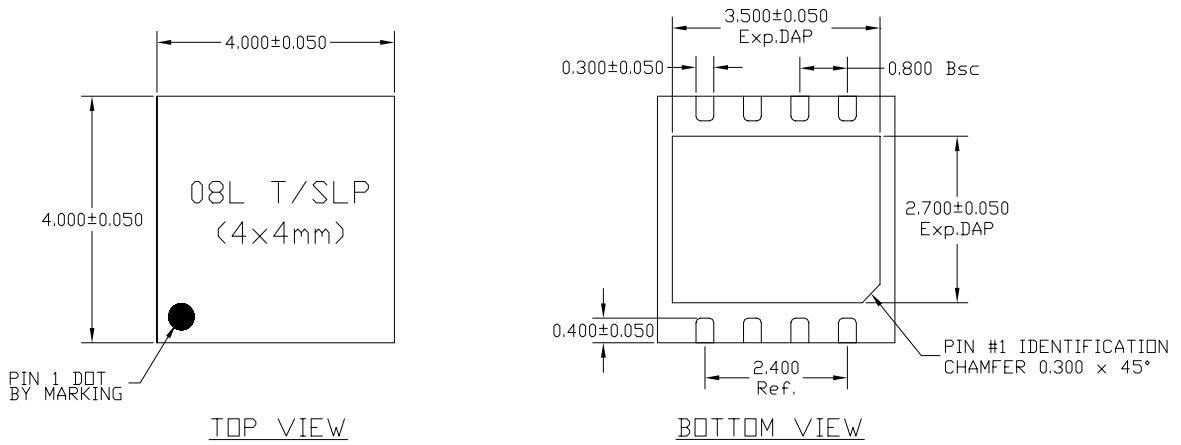

NOTE:
1) TSLP AND SLP SHARE THE SAME EXPOSE OUTLINE BUT WITH DIFFERENT THICKNESS:

A		TSLP	SLP
	MAX.	0.800	0.900
NDM.	0.750	0.850	
MIN.	0.700	0.800	

IXYS Corporation makes no representations or warranties with respect to the accuracy or completeness of the contents of this publication and reserves the right to make changes to specifications and product descriptions at any time without notice. Neither circuit patent licenses nor indemnity are expressed or implied. Except as set forth in IXYS' Standard Terms and Conditions of Sale, IXYS Corporation assumes no liability whatsoever, and disclaims any expressed or implied warranty, relating to its products including, but not limited to, the implied warranty of merchantability, fitness for a particular purpose, or infringement of any intellectual property right.

IXYS Corporation

3540 Bassett Street
Santa Clara, CA 925054
Tel: 1-408-982-0700
Fax: 1-408-496-0670
e-mail:sales@ixys.net

Micronix

145 Columbia
Aliso Viejo, CA 92656-1490
Tel: 1-949-831-4622
Fax: 1-949-831-4628

SALES OFFICES AMERICAS**Eastern Region**

[Eastern North America, Mexico, South America]
IXYS Corporation
Beverly, MA
Tel: 508-528-6883
Fax: 508-528-4562
wgh@ixys.net

Central Region

[Central North America]
IXYS Corporation
Greensburg, PA
Tel: 724-836-8530
Fax: 724-836-8540
neil.lejeune@westcode.com

Western Region

[Western North America]
IXYS Coporation
Solana Beach, CA
Tel: 858-792-1101
slodor@ix.netcom.com

SALES OFFICES EUROPE**European Headquarters**

IXYS Semiconductor GMBH
Edisonstrasse 15
D- 68623 Lampertheim
Germany
Tel : 49-6206-503203
Fax: 49-6206-503286
marcom@ixys.de

United Kingdom

IXYS Semiconductor Limited
Langley Park Way
Langley Park
Chippenham
Wiltshire SN 15 1GE - England
Tel: 44-1249-444524
Fax: 44-1249-659448
sales@ixys.co.uk

Sales Offices ASIA / PACIFIC**Asian Headquarters**

IXYS
Room 1016, Chia-Hsin, Bldg II,
10F, No. 96, Sec. 2
Chung Shan North Road
Taipei, Taiwan R.O.C.
Tel: 886-2-2523-6368
Fax: 886-2-2523-6368
bradley.green@ixys.co.uk
Jhong@clare.com

Check the IXYS Website for the local sales office nearest you. (www.ixys.com)

<http://www.claremicronix.com>

IXYS cannot assume responsibility for use of any circuitry other than circuitry entirely embodied in this IXYS product. No circuit patent licenses nor indemnity are expressed or implied. IXYS reserves the right to change the specification and circuitry, without notice at any time. The products described in this document are not intended for use in medical implantation or other direct life support applications where malfunction may result in direct physical harm, injury or death to a person.

Specification: MX8682
©Copyright 2001, IXYS Corporation
All rights reserved. Printed in USA.