



UX series

US series

• Features

<UX series>

- Provided with quick-connect* socket
- Can be extended up to 5 m through extension cable (option)
- The CPU enables the following various functions:
 1. Digital setting of revolving speeds
 2. Instantaneous conversion of gear head speed and conveyor speed
 3. Digital display of actual speed
 4. Soft-start, soft-down
 5. Backup of setting conditions
 6. Set locking

<US series>

- Provided with quick-connect* socket
- Can be extended up to 5 m through extension cable (option)

* When connected (B-323 page) unit motor.

• UX series

- Please refer to pages B-324 to B-340 to check the specification and combination of motor and speed controller.
- When ordering the motor and speed controller as a set, place an order using the unit model number.

• Part No.

Capacity	Voltage	UX series
6 W	100 V	DVUX606L
	200 V	DVUX606Y
15 W	100 V	DVUX715L
	200 V	DVUX715Y
25 W	100 V	DVUX825L
	200 V	DVUX825Y
40 W	100 V	DVUX940L
	200 V	DVUX940Y
60 W	100 V	DVUX960L
	200 V	DVUX960Y
90 W	100 V	DVUX990L
	200 V	DVUX990Y

• Specification

	UX series
Output	6 W : 15 W : 25 W : 40 W : 60 W : 90 W
Rated voltage	single-phase 100 VAC / single-phase 200 VAC
Power frequency	50 Hz / 60 Hz
Speed control range	90 r/min to 1400 r/min / 90 r/min to 1700 r/min
Speed variation	5 % (standard value)
Speed setting	Digital
Operating temperature	0 °C to 40 °C
Storage temperature	-10 °C to 60 °C
Soft-start/soft-down time	0.1 sec to 30 sec

- The 90 W models contain a thermal protector to prevent burnout for motor.

• US series

- Please refer to pages B-324 to B-340 to check the specification and combination of motor and speed controller.
- When ordering the motor and speed controller as a set, place an order using the unit model number.

• Part No.

Capacity	Voltage	US series
6 W	100 V	DVUS606L
	200 V	DVUS606Y
15 W	100 V	DVUS715L
	200 V	DVUS715Y
25 W	100 V	DVUS825L
	200 V	DVUS825Y
40 W	100 V	DVUS940L
	200 V	DVUS940Y
60 W	100 V	DVUS960L
	200 V	DVUS960Y
90 W	100 V	DVUS990L
	200 V	DVUS990Y

• Specification

	US series
Output	6 W : 15 W : 25 W : 40 W : 60 W : 90 W
Rated voltage	single-phase 100 VAC / single-phase 200 VAC
Power frequency	50 Hz / 60 Hz
Speed control range	90 r/min to 1400 r/min / 90 r/min to 1700 r/min
Speed variation	5 % (standard value)
Speed setting	Analog
Operating temperature	-10 °C to 40 °C
Storage temperature	-20 °C to 60 °C
Soft-start/soft-down time	—

- The 90 W models contain a thermal protector to prevent burnout for motor.

* Please read your User's manual carefully so that you will understand the operation and safety precautions before attempting to operate the system.

• Outline drawing

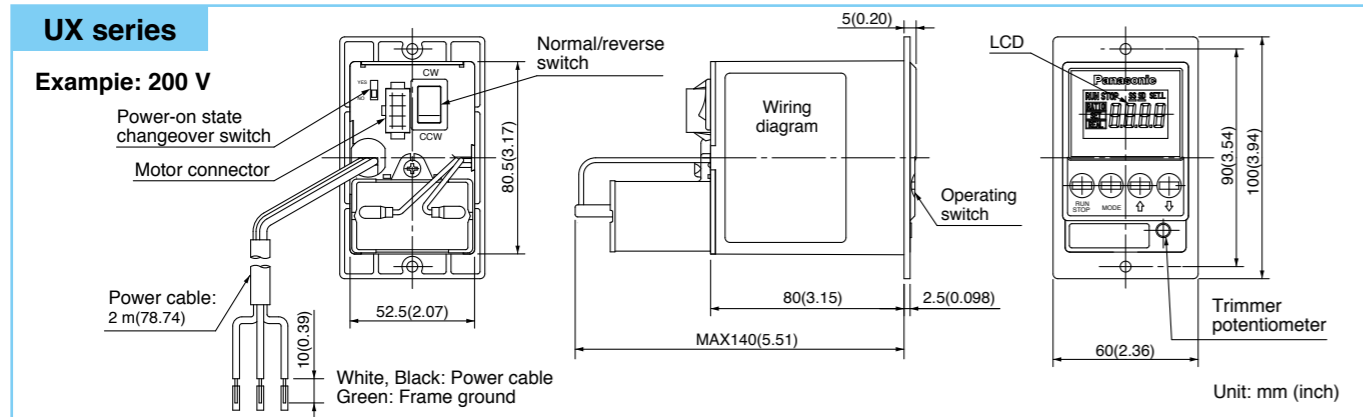

• Names and functions

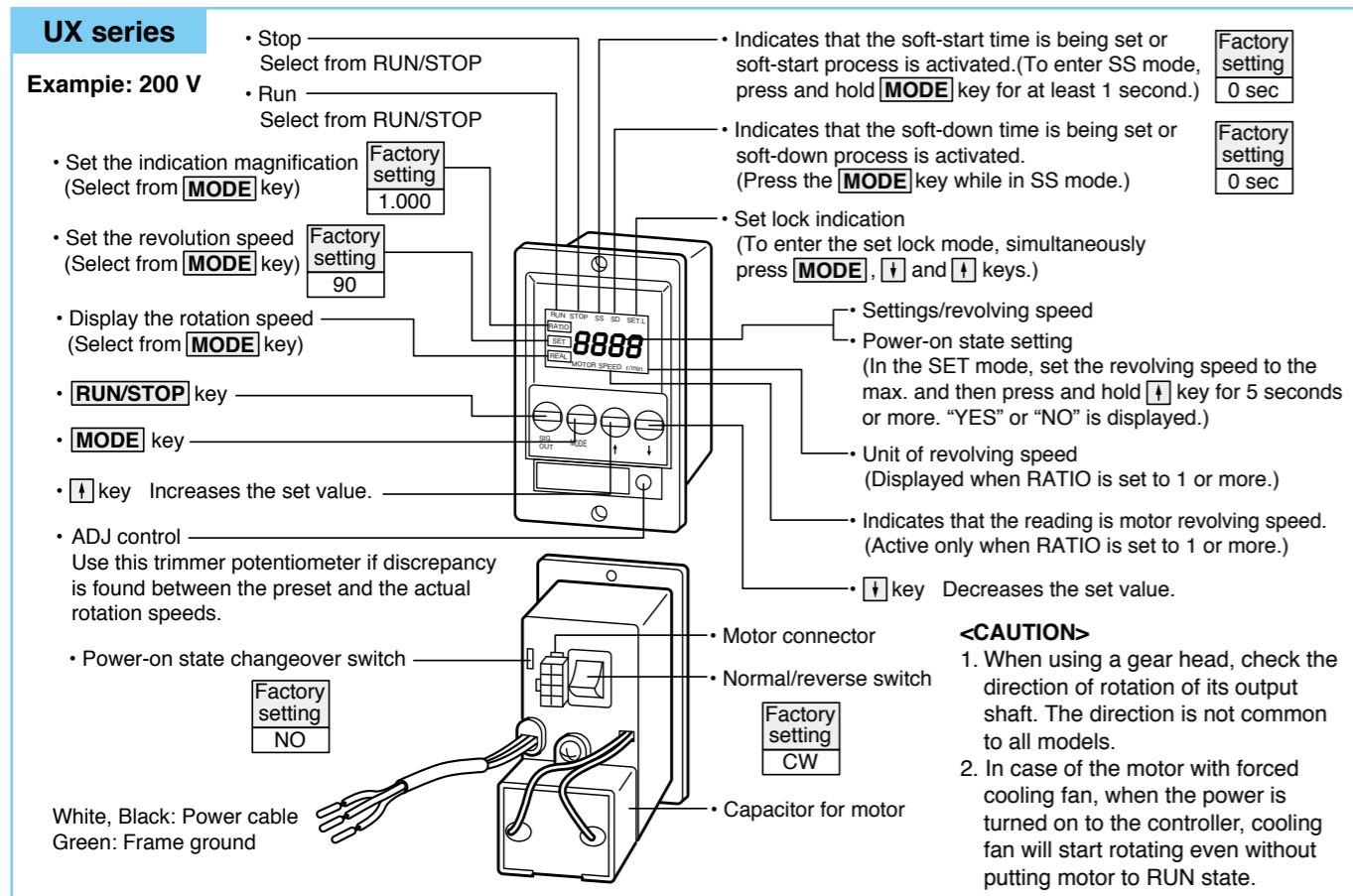

Wiring diagram

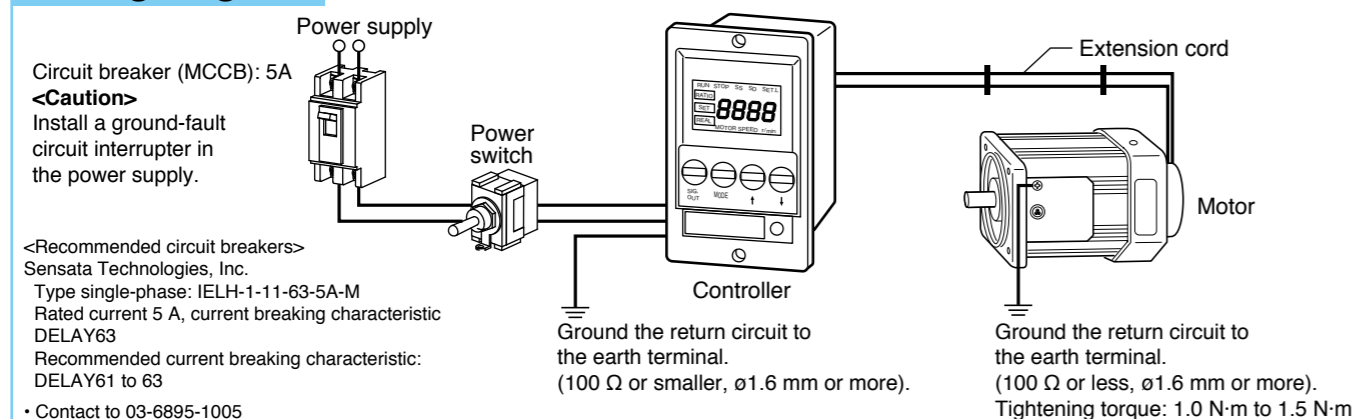

* Please read your User's manual carefully so that you will understand the operation and safety precautions before attempting to operate the system.

• Operating method and preparation (UX series)

- Check the Power-on state setting.
- Setting the Normal/reverse switch. (Switch on the back of the controller.)
- Connect the "motor connector".
- Turn on power.
- Setting of display magnification(RATIO mode), rotation speed (SET mode), soft start/down (SS/SD mode).
- Press the RUN key, motor will rotating.

► Power-on state setting

The state of the unit upon power-up can be preset from the power-on state setting switch.

(1) "YES"
Upon power-on, the unit reproduces the state as it was turned off.

(2) "NO"
Upon power-on, the unit is in stop mode regardless of the state at the previous power off.
To restart, operate RUN-STOP key.

Previous state	Upon power-on
"STOP"	→ Startup (after approx. 2 sec)
"RUN"	→ Startup (after approx. 2 sec)

Previous state	Upon power-on
"STOP"	→ Stop
"RUN"	→ Stop

• Modes of operation (UX series)

► RATIO mode

By setting the speed in unit of motor revolving speed multiplied by the factor or by displaying the actual speed, gear head output shaft speed or belt conveyor travel speed can be converted. The RATIO mode is used to set the factor.

Selection of indication magnification can be made from **↑** and **↓** keys.

Reduction gear ratio setting value (to display the settings in terms of gear head output shaft speed)
<"SET" or "REAL" reading = motor revolving speed divided by gear reduction settings>

The reduction ratios of Panasonic gear head are stored in the unit, choose the suitable one by using **↑** and **↓** keys:
1.000→3→... 100 ...→202 ...→1000 ...→2020

Multiple number setting value (to display the settings in terms of the speed of belt conveyor)
<"SET" or "REAL" reading = motor revolving speed multiplied by multiplication factor>

Multiplication can be set by the factor of 0.005 to 0.995:
select the desired one from **↑** and **↓** keys.
1.000→0.995→...→0.015→0.010→0.005
(in unit of 0.005)

► SET mode

In this mode, the revolving speed can be set to a value within the range shown below, by using **↑** and **↓** keys.

[With reading magnification 1.000]
Value can be set in unit of 10 r/min.

<Example>

- Power frequency 50 Hz : 90→100→110 ...→1400 r/min
- Power frequency 60Hz : 90→100→110 ...→1400 ...1700 r/min

[With reading magnification other than 1.000]
Readings are based on the reading magnification setting in RATIO mode and gear reduction ratio setting. Desired value can be selected among the values shown below, by using **↑** and **↓** keys.

<Example> Reduction gear ratio = 3
Selection unit is 10/3 r/min. The reading rounds off fraction.
• Power frequency 50 Hz: 29.9→33.3→36.6 ...→466.6 r/min
• Power frequency 60 Hz: 29.9→33.3→36.6 ...→466.6 ...→566.6 r/min

<Example> Magnification = 0.500
Selection unit is 10 x 0.500. The reading rounds off fraction.
• Power frequency 50 Hz: 45.0→50.0→55.0 ...→700.0
• Power frequency 60 Hz: 45.0→50.0→55.0 ...→700.0 ...850.0

[Note] Exception: reading magnification 1.000 "MOTOR SPEED r/min" is displayed. Only "r/min" is displayed when the value exceeds 1.000. Otherwise, nothing is displayed.

► REAL mode

In the REAL mode, motor's real revolutions multiplied by the reading magnification is displayed.

[Reading magnification 1.000]
The speed is displayed in unit of 5 r/min.

<Example>

- 0→5 ...→90→100→110 ...→1400 ...→1700 r/min
- [With reading magnification other than 1.000]
Readings are based on the reading magnification setting in RATIO mode and gear reduction ratio setting.

<Example> Reduction gear ratio = 3
Selection unit is 5/3 r/min. The reading rounds off fraction.
0→1.6 ...→29.9→33.3→36.6 ...→466.6 ...→566.6 r/min
<Example> Magnification = 0.500
Selection unit is 10 x 0.500. The reading rounds off fraction.
0→2.5 ...→45.0→50.0→55.0 ...→700.0 ...→850.0

[Note] Exception: reading magnification 1.000 "MOTOR SPEED r/min" is displayed. Only "r/min" is displayed when the value exceeds 1.000. Otherwise, nothing is displayed.

* Please read your User's manual carefully so that you will understand the operation and safety precautions before attempting to operate the system.

Speed controller Unit type UX series

► Soft start (SS) / Soft down (SD) setting mode

To enter SS mode, press and hold MODE key for at least 1 second. To enter SD mode, press the MODE key while in SS mode.

The Soft start · Soft down time in each mode to be set individually, and you can select a value by \uparrow and \downarrow key. In unit of 0.1 sec, up to 30 sec.

Note 1) Soft start (SS) · Soft down (SD)

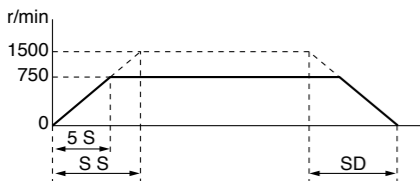

The Soft start · Soft down time is defined as the time required to change revolving speed between 0 r/min and 1500 r/min.

<Example>

When the soft-start time is set to 10 seconds and “SET” revolving speed is 750 r/min, then,

$$10 \times \frac{750 \text{ r/min}}{1500 \text{ r/min}} = 5$$

This means that 5 seconds are required to change from 0 r/min to 750 r/min. The same applies to “SD”.

Note 2)

In the practical application, speed change time will be longer than the Soft start · Soft down time if the load inertia is large.

Speed controller Unit type US series

• Outline drawing

US series

• 40 W or smaller (w/ internal capacitor)
Example: 200 V

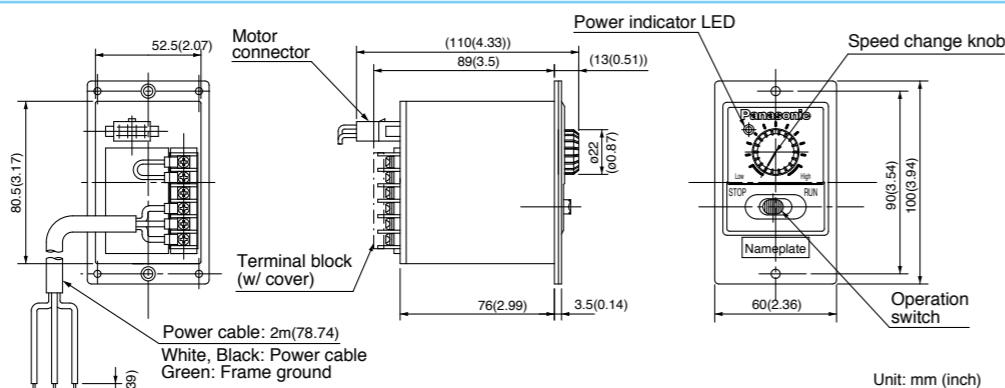

• 60 W or larger
Example: 200 V

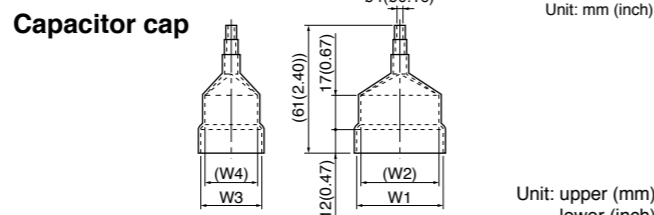
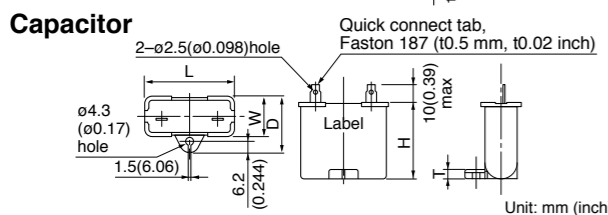
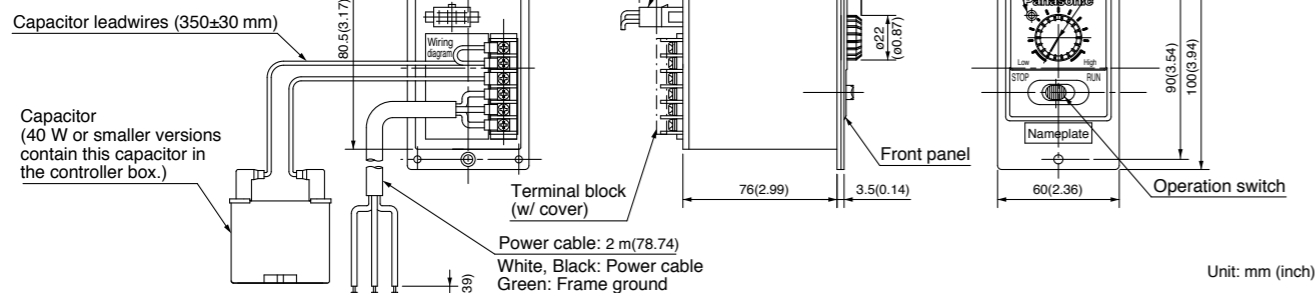

Capacitor part No.	Voltage	Designation	L	W	D	H	T	Capacitor cap part No.	W1	W2	W3	W4
M0PC20M20	100 V	MUSN960GL	50.2 (1.98)	26.7 (1.05)	37 (1.46)	36 (1.42)	4 (0.16)	M0PC5026	50 (1.97)	48 (1.89)	26 (1.02)	22 (0.87)
M0PC5M40	200 V	MUSN960GY	50 (1.97)	30.5 (1.20)	41 (1.61)	41.5 (1.63)	4 (0.16)	M0PC5032	50 (1.97)	48 (1.89)	32.5 (1.28)	29.5 (1.16)
M0PC25M20	100 V	MUSN990GL	50.2 (1.98)	31 (1.22)	41 (1.61)	42 (1.65)	4 (0.16)	M0PC5032	50 (1.97)	48 (1.89)	32.5 (1.28)	29.5 (1.16)
M0PC6.2M38	200 V	MUSN990GY	50 (1.97)	30.5 (1.20)	41 (1.61)	41.5 (1.65)	4 (0.16)	M0PC5032	50 (1.97)	48 (1.89)	32.5 (1.28)	29.5 (1.16)

* Please read your User's manual carefully so that you will understand the operation and safety precautions before attempting to operate the system.

Speed controller Unit type US series

• Names and functions

US series

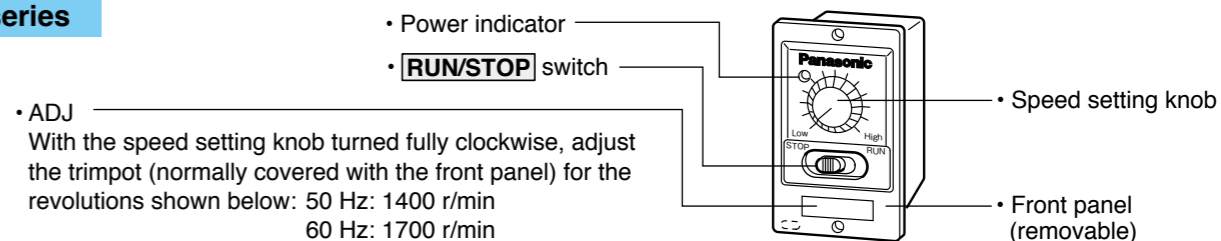

Wiring diagram

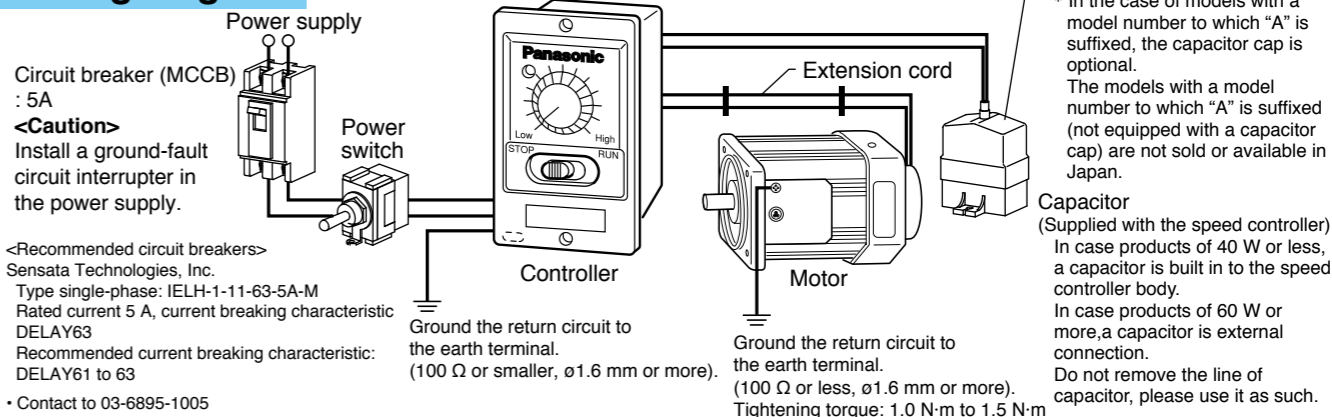

• Operating method (US series)

1. Connect the “motor connector”.
2. Make sure that the **RUN/STOP** switch is in “STOP” position. Connect the power cable to the AC source.
3. Turn on power. “Power” indicator will light.
4. Place the **RUN/STOP** switch in “RUN” position, and the motor starts.
CAUTION: Do not place the switch lever in between RUN and STOP.
5. To stop the motor, move the lever to “STOP” position.
 Note that the **RUN/STOP** switch does not turn on/off power supply: when not using the motor for a long period, turn off the main power switch.
6. If there is a forced cooling fan equipped to the motor, the fan will start rotating when power is turned on to the controller. In order to stop the forced cooling fan, please turn off the source of power to the controller.

• Changing direction of rotation (US series)

• Unidirectional rotatio

Terminal “CW” or “CCW” on the controller rear panel should be left open.

Direction when viewed from motor output shaft end	
Clockwise	Connect COM to CW
Counterclockwise	Connect COM to CCW

[Note] When a gear head is connected, the direction of its output shaft may or may not be the same as that of motor shaft depending on the reduction ratio.

• Normal/reverse rotation

When it is necessary to select the rotating direction, connect the switch as shown in the figure.

[Note]

Do not operate this switch while the motor is running.

Switch specification	
• Single-pole double-throw: ON-OFF-ON	
• 100 V power: 5 A at 200 VAC or more	
• 200 V power: 3 A at 400 VAC or more	

40 W or smaller (Built-in capacitor)

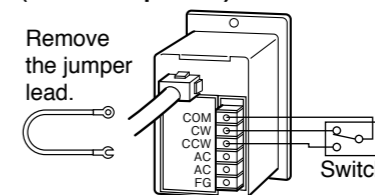

60 W or larger

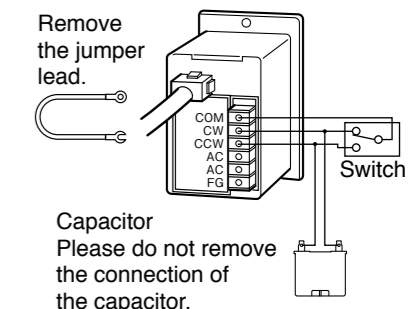

* Please read your User's manual carefully so that you will understand the operation and safety precautions before attempting to operate the system.

• Mounting method (UX series, US series)

<Mounting through square holes>

UX series, US series

Unit: mm (inch)

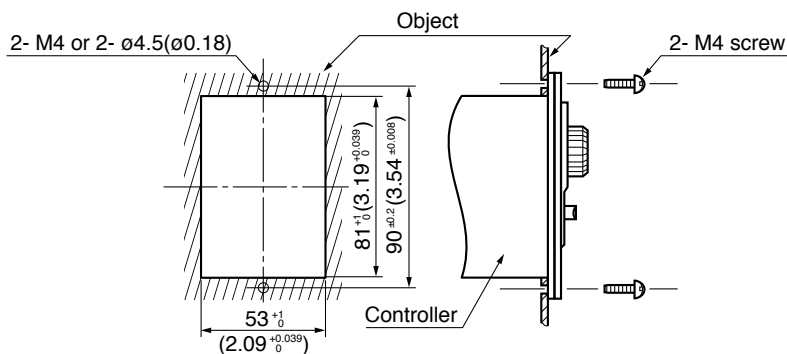

Mounting procedure

1. Drill 2 square holes in the object.
2. Secure the controller and front panel with 2 M4 screws.

<Mounting without using square hole>

US series only

Unit: mm (inch)

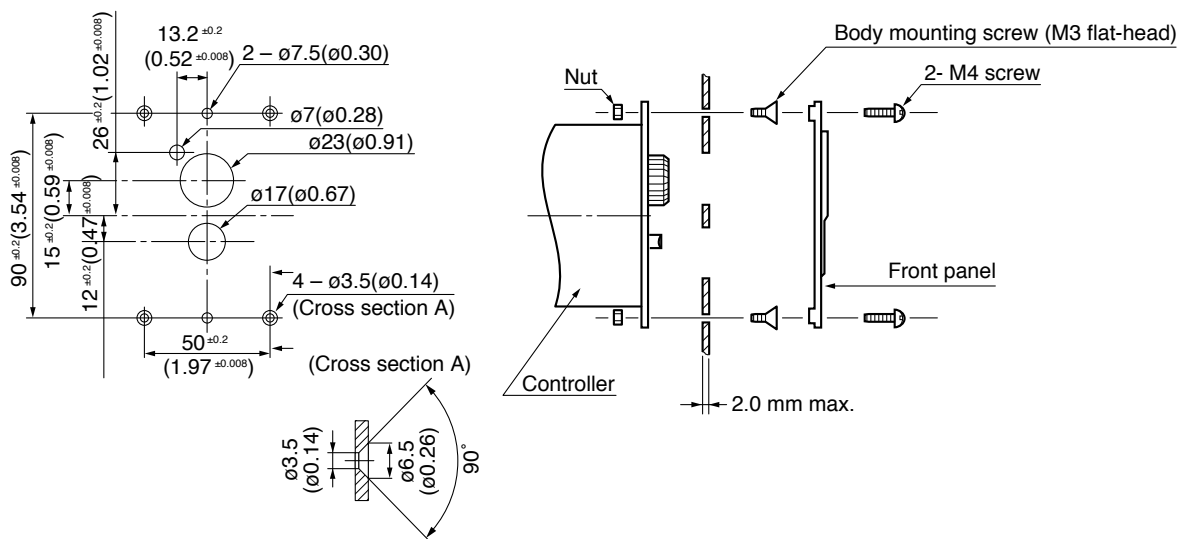

Caution

Wall thickness of the equipment where the controller is to be mounted should be 2 mm or less.

Mounting procedure

1. Drill 2 square holes in the wall of the object.
2. Remove the front panel from the controller.
3. Secure the controller body with M3 flat-head screws and nuts.
4. Place the front panel on the wall and secure the panel with M4 screws and nuts.

<To install controller and motor separately>

When installing the speed controller at a distance more than 1 m from the motor, use optional "extension cord" that is supplied as standard accessory (allowable distance 5 m). Refer to page D-4 (Option).