

High Reliability of Fiber Optic Amplifier for Convenient Mounting

■ Features

- High speed response: max. 0.5ms
- Auto sensitivity setting (button setting)/external input sensitivity setting type
- External synchronization input, mutual interference protection, self-diagnosis
- Reverse power polarity protection and output short overcurrent protection circuit
- Timer function: selectable none / 40ms OFF delay timer (fixed)
(standard type, remote sensitivity setting type only)
- Automatically selectable Light ON / Dark ON
- Precise detection of small target and easy to install in the complicated place



⚠ Please read "Safety Considerations" in the instruction manual before using.



■ Ordering Information

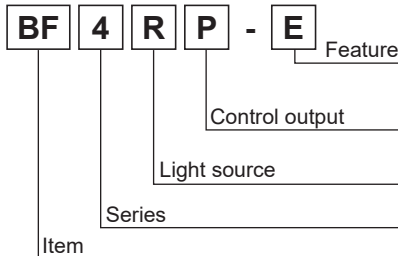

No mark	Standard type
E	External synchronization input type
R	External input sensitivity setting type
No mark	NPN open collector output
P	PNP open collector output
R	Red LED
G	Green LED
4	Series
BF	Fiber Sensor

■ Specifications

Model	Standard type				External synchronization input type		External input sensitivity setting type	
	BF4RP	BF4GP	BF4R	BF4G	BF4R-E	BF4G-E	BF4R-R	BF4G-R
Light source	Red LED (660nm)	Green LED (525nm)	Red LED (660nm)	Green LED (525nm)	Red LED (660nm)	Green LED (525nm)	Red LED (660nm)	Green LED (525nm)
Power supply	12-24VDC \pm 10% (ripple P-P: max.10%)							
Current consumption	Max. 45mA							
Operation mode	Light ON/Dark ON switching							
Control output	NPN or PNP open collector output ● Load voltage: max. 30VDC \pm ● Load current: max. 100mA ● Residual voltage - NPN: max. 1V (load current: 100mA), max. 0.4V (load current: 16mA) / PNP: max. 2.5V							
Protection circuit	Reverse power polarity protection circuit, output short overcurrent protection circuit							
Response time	Max. 0.5ms (frequency 1), max. 0.7ms (frequency 2)							
Sensitivity setting	Sensitivity setting button (ON/OFF)							
Indicator	Control output indicator (OUT): red LED, Stability indicator (STAB): green LED (turns ON at stable light ON/OFF level)							
Mutual interference prevention	Built-in differential frequency mode (frequency 1 (normal mode): max. 0.5ms, frequency 2: max. 0.7ms)							
Self-diagnosis output	ON state under unstable sensing (when the target stays for 300ms in unstable level), ON state when control output is short-circuited ● Load voltage: max. 30VDC \pm ● Load current: max. 50mA ● Residual voltage - NPN: max. 1V (load current: 50mA), max. 0.4V (load current: 16mA) / PNP: max. 2.5V							
Input of stop transmission function	—				Built-in		—	
External synchronization function	—				Built-in (gate/trigger)		—	
Remote sensitivity setting function	—				—		Built-in	
Timer function	OFF delay (40ms)				—		OFF delay (40ms)	
Insulation resistance	Over 20M Ω (at 500VDC megger)							
Noise immunity	\pm 240V the square wave noise (pulse width: 1 μ s) by the noise simulator							
Dielectric strength	1,000VAC 50/60Hz for 1 minute							
Vibration	1.5mm amplitude at frequency of 10 to 55Hz (for 1 min) in each X, Y, Z direction for 2 hours							
Shock	500m/s ² (approx. 50G) in each X, Y, Z direction for 3 times							
Environment	Ambient illumination	Sunlight: max. 11000lx, Incandescent lamp: max. 3000lx (received illumination)						
	Ambient temperature	-10 to 50°C, storage: -20 to 70°C						
	Ambient humidity	35 to 85% RH, storage:35 to 85% RH						
Material	Case: heat-resistance acrylonitrile butadiene styrene, cover: polycarbonate							
Cable	Ø4mm, 4-wire, 2m (AWG22, core diameter: 0.08mm, number of cores: 60, insulator out diameter: Ø1.25mm)				Ø4mm, 6-wire, 2m (AWG24, core diameter: 0.08mm, number of cores: 40, insulator out diameter: Ø1mm)			
Accessory	Mounting bracket, bolts, nuts							
Approval	CE							
Weight ^{*1}	Approx. 120g (approx. 65g)							

※1: The weight includes packaging. The weight in parenthesis is for unit only.

※ The temperature or humidity mentioned in Environment indicates a non freezing or condensation environment.

Fiber Optic Amplifier

Feature Data

Through-beam type

● Measurement: BF4□(-□) + FT-420-10

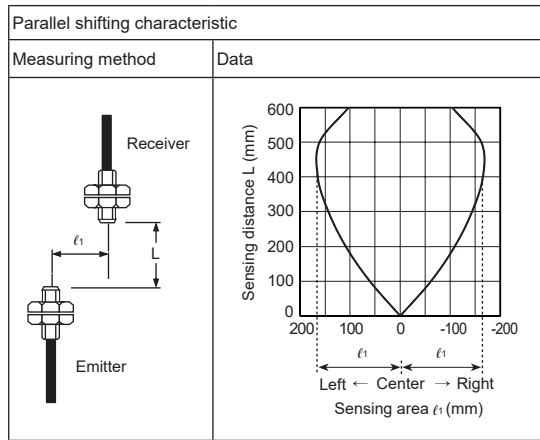

Diffuse reflective type

● Measurement: BF4□(-□) + FD-620-10

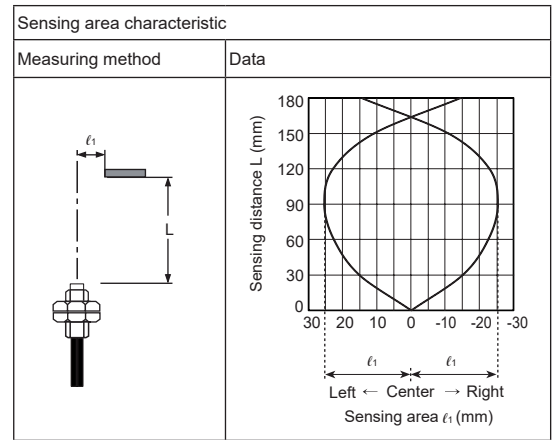

Control Output Diagram

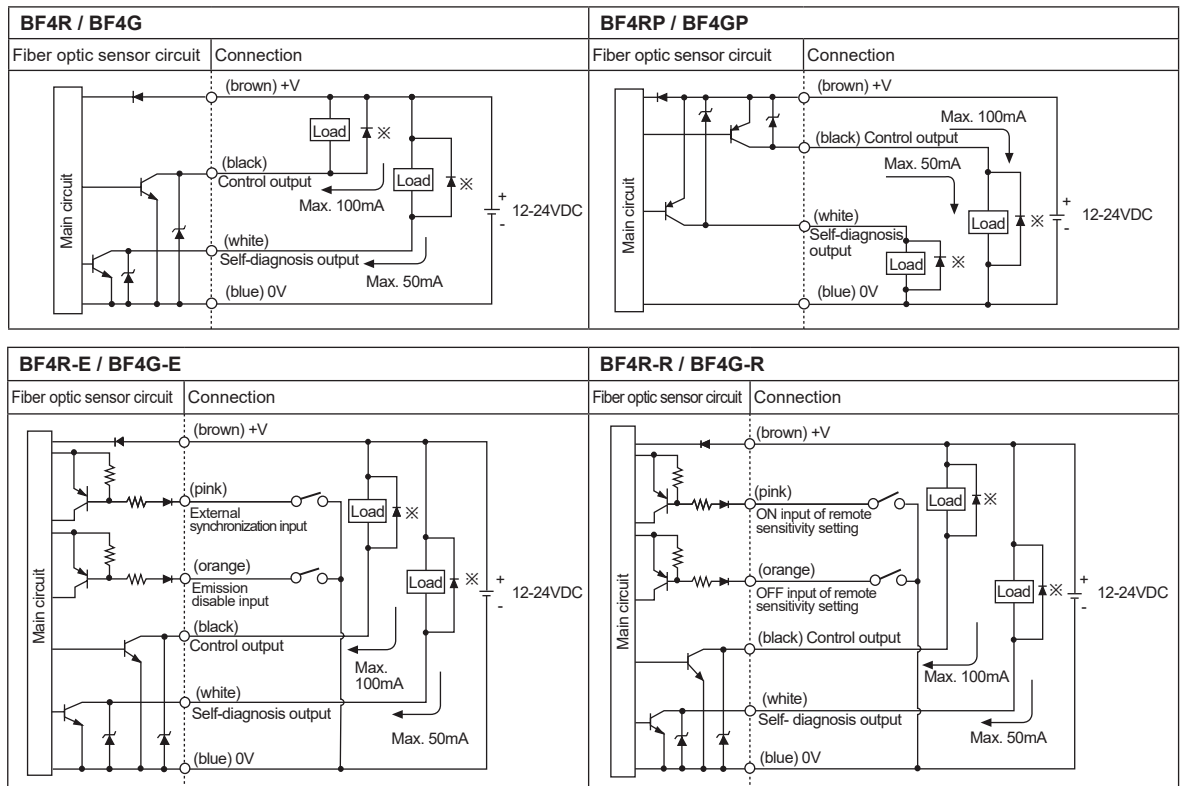

※ Connect Diode at external terminal for inductive load.

SENSORS

CONTROLLERS

MOTION DEVICES

SOFTWARE

(A) Photoelectric Sensors

(B) Fiber Optic Sensors

(C) LIDAR

(D) Door/Area Sensors

(E) Vision Sensors

(F) Proximity Sensors

(G) Pressure Sensors

(H) Rotary Encoders

(I) Connectors/ Connector Cables/ Sensor Distribution Boxes/ Sockets

BF4 Series

■ Connections

● BF4R / BF4G

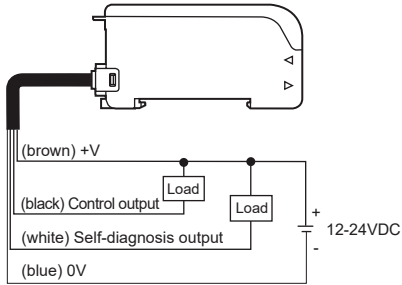

● BF4RP / BF4GP

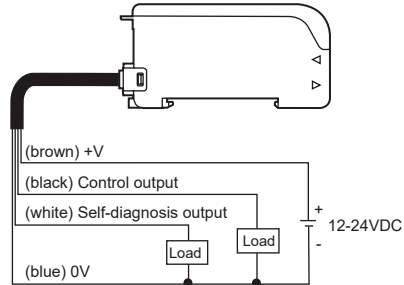

● BF4R-E / BF4G-E

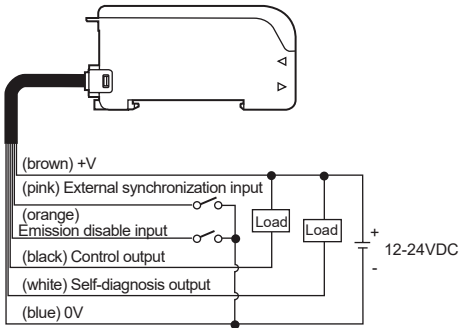

● BF4R-R / BF4G-R

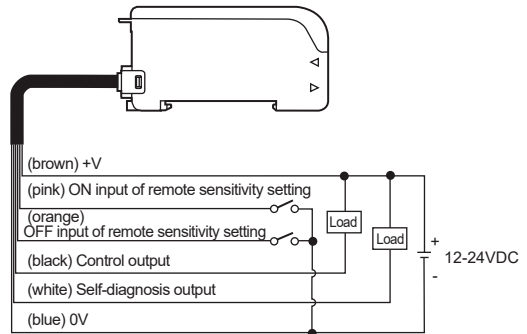

■ Dimensions

(unit: mm)

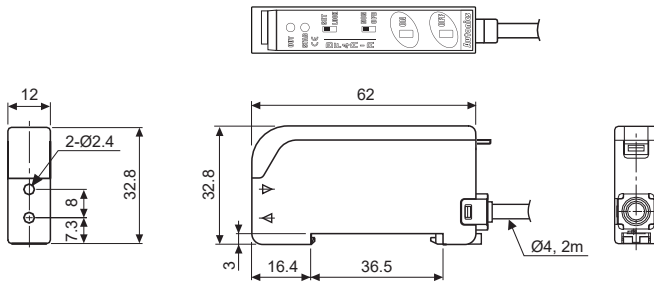

● Connect the bracket

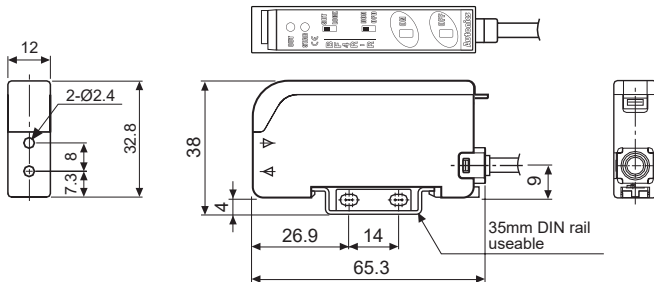

● Bracket

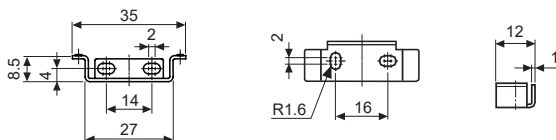

Fiber Optic Amplifier

■ Installations

◎ Mounting amplifier unit

- Hook the front part of the amplifier on DIN rail. Press the rear part of the amplifier on DIN rail.
- Push the back of amplifier toward ① and lift the hole for fiber toward ② up then simply take it out without tools.

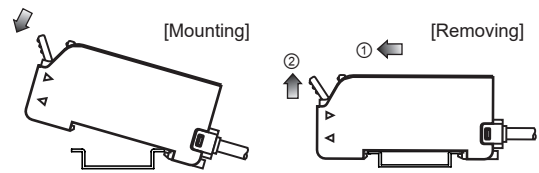

◎ Installation of fiber optic cable

- Lift up the protective cover to the ① direction to release the lock setting.
- Insert the cable to the ② direction and adhere between the cable and the inside of the amplifier unit. (insert depth: approx. 10mm)
- Place up the lock lever to ③ direction to lock the lock setting and close the protective cover.

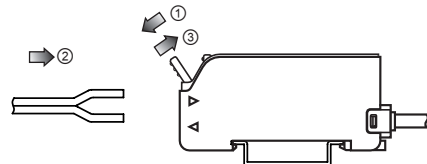

◎ Connection of fiber optic cable & amplifier

• In case of using L bracket

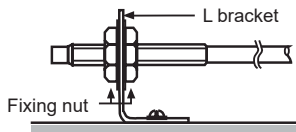

• In case of using screw

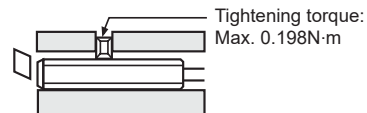

※Notice: If setting bolt is tightened with over specified tightening torque, hood of fiber optic cable may be damaged.

■ Unit Description

• Standard type (BF4R/BF4RP/BF4G/BF4GP) External input sensitivity setting type (BF4□-R)

• External synchronization input type (BF4□-E)

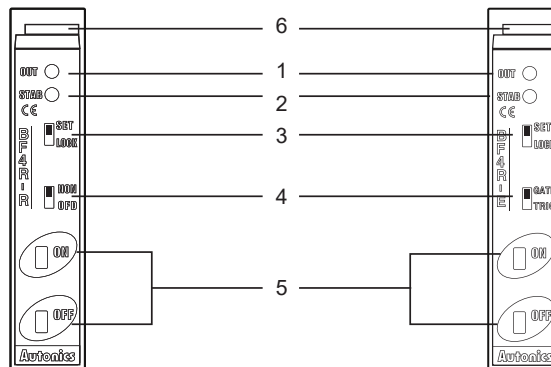

- 1. Control output indicator (red):** Turns ON or OFF by control output status.
- 2. Stability indicator (green):** Turns ON at stable light ON/OFF level.
- 3. Mode setting switch - SET:** Set the switch to [SET] to use set the function.
- LOCK: Set the switch to [LOCK] not to set the function.
- 4. Timer setting switch (standard type, external input sensitivity setting type)**
- NON: Set the switch to [NON] not to use timer function.
- OFD: Set the switch to [OFD] to use OFF Delay timer function.
- External synchronization setting switch (external synchronization input type)**
- GATE: Set the switch to [GATE] to use external synchronization as gate synchronization.
- TRIG: Set the switch to [TRIG] to use external synchronization as trigger synchronization.
- 5. Sensitivity setting button:** Used for sensitivity setting
- 6. Lock lever:** Used for connecting fiber optic cable.

SENSORS

CONTROLLERS

MOTION DEVICES

SOFTWARE

(A)
Photoelectric
Sensors

(B)
Fiber Optic
Sensors

(C)
LIDAR

(D)
Door/Area
Sensors

(E)
Vision
Sensors

(F)
Proximity
Sensors

(G)
Pressure
Sensors

(H)
Rotary
Encoders

(I)
Connectors/
Connector Cables/
Sensor Distribution
Boxes/ Sockets

BF4 Series

Mode Setting

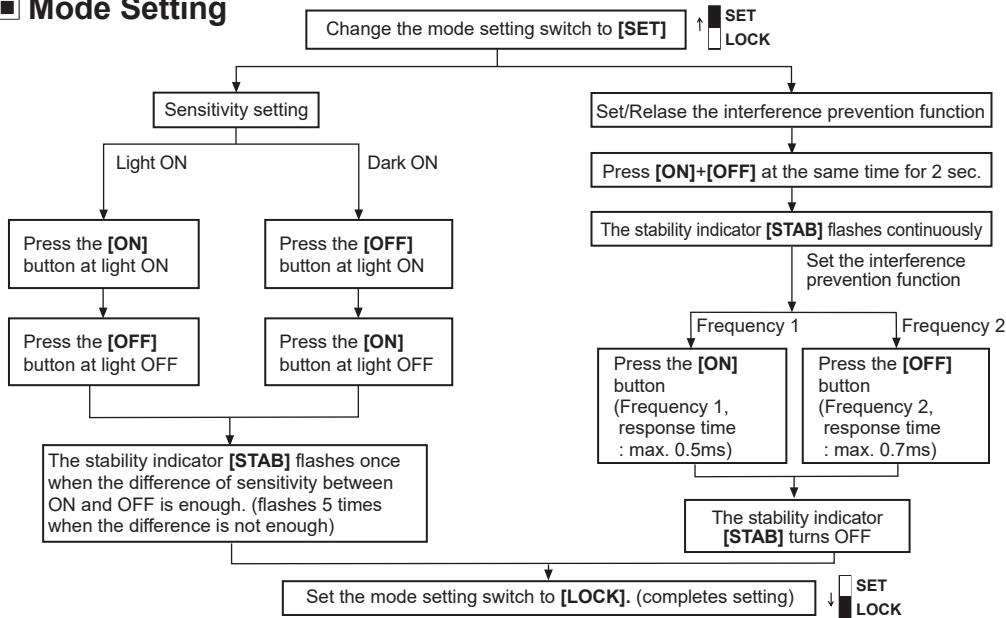

Sensitivity Adjustment

Before sensitivity setting, install the fiber optic cable.

After completing the setting, do not move or bend the fiber optic cable. If not, it may cause incorrect detection.





Adjustment by the sensitivity setting button (common)

Light ON

The control output turns on at Light ON status and turns off at Light OFF status.

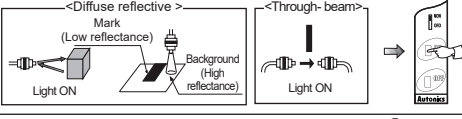
Dark ON

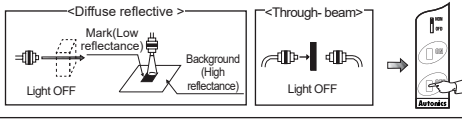
The control output turns off at Light ON status and turns on at Light OFF status.

Order	Setting method
①	Mount the fiber optic cable within sensing distance.
②	Change the mode setting switch to [SET]. 
③	Diffuse reflective: Press the [ON] button with a sensing target. Through-beam: Press the [ON] button without a sensing target. 
④	The stability indicator [STAB] (green) flashes at ON state. (check the target position) 
⑤	Diffuse reflective: Press the [OFF] button without a sensing target. Through-beam: Press the [OFF] button with a sensing target. 
⑥	•When there is enough sensitivity difference between ON state and OFF state, the stability indicator [STAB] flashes one time only at stable sensing level. •When there is not enough sensitivity difference between ON state and OFF state, the stability indicator [STAB] flashes five times at unstable sensing level. ※The sensitivity can be set at unstable sensing area.
⑦	Change the mode selection switch to [LOCK] to fix the set sensitivity. Even though the sensitivity setting button is touched, setting sensitivity shall not be changed. 

※When the power is OFF, the set sensitivity is saved.

<How to set sensitivity>

The setting order are same as Light ON mode except ③ & ⑤. The ③ & ⑤ order is opposite from Light ON.

- ③ state

Diffuse reflective: Press the [ON] button without a sensing target.
Through-beam: Press the [ON] button with a sensing target.

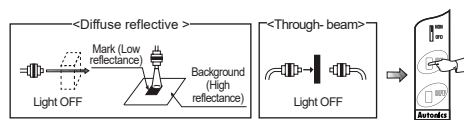

- ⑤ state

Diffuse reflective: Press the [OFF] button with a sensing target.
Through-beam: Press the [OFF] button without a sensing target.

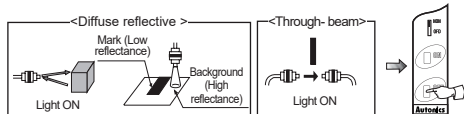

◎ Setting as max. sensitivity (common)

- ① Set the mode setting switch to [SET].
- ② If there is no sensing target,
 - **Light ON**: Press the [ON → OFF] button
 - **Dark ON**: Press the [OFF → ON] button
- ③ Set the mode selection switch to [LOCK] mode.

※ External sensitivity setting

- **Light ON** (From above ③)
External sensitivity setting **ON** input (High→Low→High)
- External sensitivity setting **OFF** input (High→Low→High)
- **Dark ON Mode** (From above ③)
External sensitivity setting **OFF** input (High→Low→High)
- External sensitivity setting **ON** input (High→Low→High)

< Application >

- To extend sensing distance (diffuse reflective type):
If fiber optic sensor is used in place where there are targets with high reflectivity and low reflectivity, it is able to get stable detection by adjusting max. sensitivity.
- Used at bad environment (through-beam type):
If fiber optic sensor is used in place where there is lots of dust or moisture, it might cause malfunction. It can perform the stable detection by using max. sensitivity.

◎ External input sensitivity setting type [BF4□-R]

External input sensitivity setting type, BF4□-R can adjust the sensitivity with input signal lines without the mode setting switch.

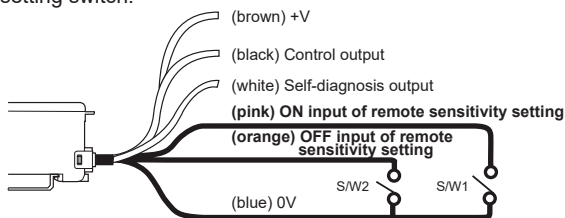

● Light ON

- ON input of remote sensitivity setting (SW1):
Turns ON the SW1 and then turn OFF instead of ③ state of adjustment by the sensitivity setting button.
- OFF input of remote sensitivity setting (SW2):
Turns on the SW2 and then turn OFF instead of ⑤ state of adjustment by the sensitivity setting button.

● Dark ON

- OFF input of remote sensitivity setting (SW2):
Turns on the SW2 and then turn OFF instead of ③ state of adjustment by the sensitivity setting button.
- ON input of remote sensitivity setting (SW1):
Turns on the SW1 and then turn OFF instead of ⑤ state of adjustment by the sensitivity setting button.

<External sensitivity setting input signal condition>

State	Signal condition
High	4.5-30VDC or Open
Low	0-1VDC

※Input impedance:10kΩ

◎ Prohibition of inputting External sensitivity setting [BF4□-R]

Even though mode switch is at Lock position, it is able to input external sensitivity setting when Switch 1 and Switch 2 are ON. Therefore please install Switch 3 in order to prevent from malfunction as below.

※SW3 - OFF: Disable to set external sensitivity

※SW3 - ON: Enable to set external sensitivity

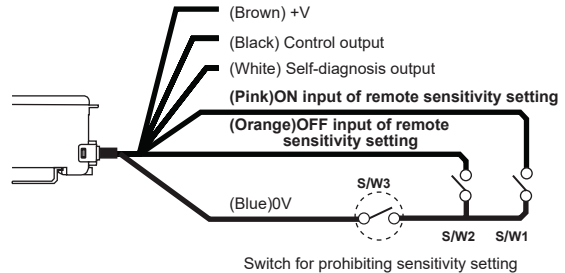

◎ Self-diagnosis output (answer back) function [BF4□-R]

When ON or OFF input of remote sensitivity setting is applied, after 300ms, self-diagnosis output turns on for 40ms and then the sensor keeps normal sensing state.

(Note: Time chart)

※Self-diagnosis output does not turn on if there is no difference of sensitivity between ON input and OFF input and stable sensing is not executed, but stable sensing operates after 340ms.

<Time Chart: Light ON mode >

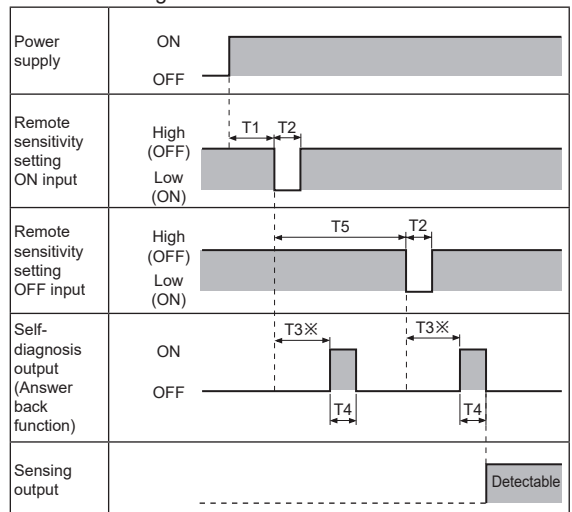

※During period T3 (approx. 300ms), do not change the received light value by moving the object, etc.

- T1≥1,000ms : after power turns ON, it can be set after 1sec.
- T2≥5ms : ON/OFF input time of remote sensitivity setting must be min. 5ms
- T3=300ms : when ON/OFF input of remote sensitivity setting is applied, self-diagnosis output turns ON after 300ms)
- T4=40ms : ON time of self-diagnosis output
- T5≥500ms : when ON input of remote sensitivity setting is applied, apply OFF input of remote sensitivity setting after 500ms

SENSORS

CONTROLLERS

MOTION DEVICES

SOFTWARE

(A) Photoelectric Sensors

(B) Fiber Optic Sensors

(C) LIDAR

(D) Door/Area Sensors

(E) Vision Sensors

(F) Proximity Sensors

(G) Pressure Sensors

(H) Rotary Encoders

(I) Connectors/ Connector Cables/ Sensor Distribution Boxes/ Sockets

■ Timer (OFF Delay) Function [BF4R/BF4G/BF4RP/BF4GP/BF4□-R]

Standard type and External input sensitivity setting type both contain the built-in OFF Delay timer, approx. 40ms. The timer works when the timer selection switch is set to [OFD].

The output turns off after remaining for additional 40ms at OFF position of the sensing output. It is useful when the response time of the connected device is slow or when the sensing signal from a tiny object is too short.

<Time Chart>

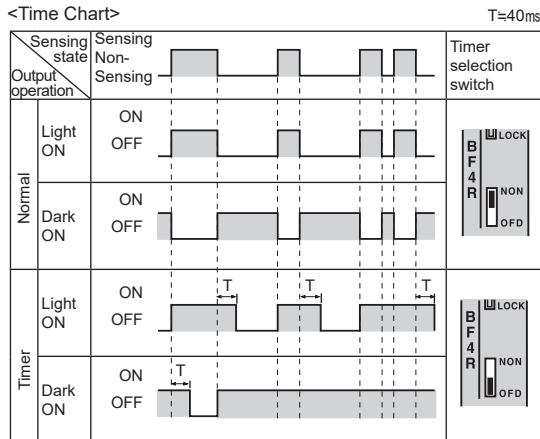

■ External Synchronization Input Function [BF4R□-E]

By using external synchronization function, the time for making sensing can be specified by external synchronization. (trigger synchronization and gate synchronization)

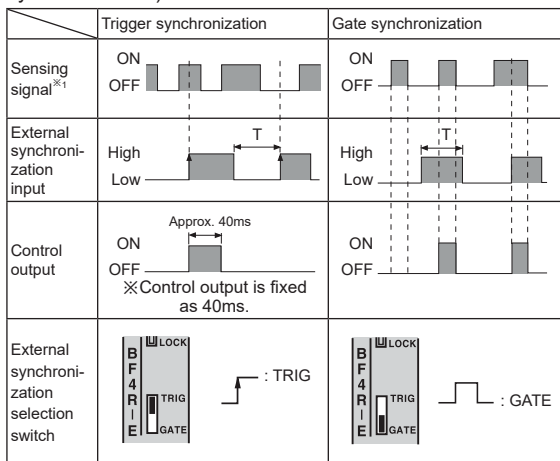

※1: Right before transfer detection signal of the sensor as control output.

※T≥0.5ms (using interference prevention function: T≥0.7ms)

<Input signal condition for External synchronization>

State	Signal condition
High	4.5-30VDC or Open
Low	0-1VDC

■ Stop Transmission Function [BF4□-E]-Operation Test

This function is available under light ON state only and it is for checking normal state of the sensor.

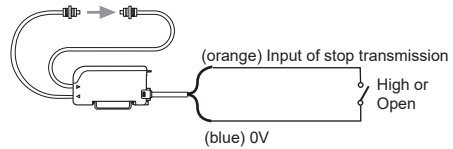

[If input of stop transmission is at High or Open state, light is transmitted.]

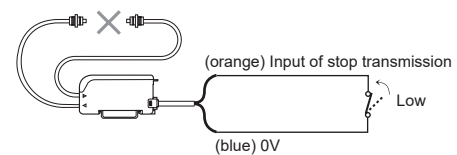

[If input of stop transmission is at Low, light is transmitted.]

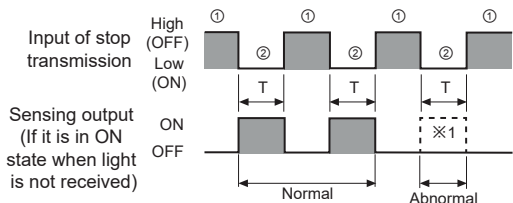

※①: Transmission area, ②: Stop transmission area

※1: If transmission is stopped, control output must turn on, but if control output does not turn on, it seems that sensor has some problems.

※T≥0.5ms

(when using interference prevention function T≥0.7ms)

<Input signal condition for Stop transmission>

State	Signal condition
High	4.5-30VDC or Open
Low	0-1VDC

Self-Diagnosis Function (common)

When fiber hood is contaminated by dust, transmitted light is lowered by element ability loss or received light is lowered by missing of optical axis, the self-diagnosis output will turn on.

In case of Light ON

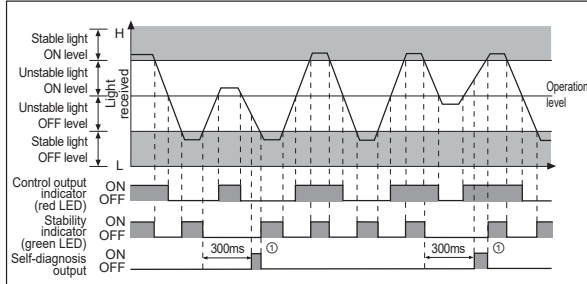

- When detecting state remains over 300ms at unstable light ON/OFF level, the self diagnosis output turns ON. In case of stable light ON/OFF level, the self diagnosis output turns OFF. (① position)

Mutual Interference Prevention Function (common)

Two fiber optic cables can be mounted very closely by setting different transmission frequencies.

Interference prevention function (operation of differential frequency mode)

First sensor- Frequency 1 (response time: max. 0.5ms)

- Set the mode setting switch to **[SET]**.
- Press the **[ON] + [OFF]** buttons for 2 sec at the same time.
- The Stability indicator **[STAB]** flashes continuously.
- Press the **[ON]** button.
- The Stability indicator **[STAB]** turns off.

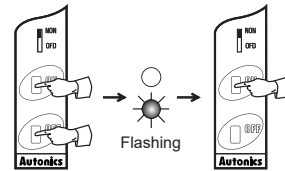
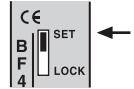

- Set the mode setting switch to **[LOCK]**.

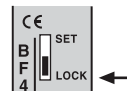

Second sensor- Frequency 2 (response time: max. 0.7ms)

- Set the mode setting switch to **[SET]**.
- Press the **[ON] + [OFF]** buttons for 2 sec at the same time.
- The Stability indicator **[STAB]** flashes continuously.
- Press the **[OFF]** button.
- The Stability indicator **[STAB]** turns off.

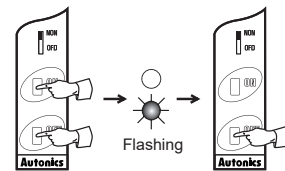
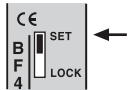

- Set the mode setting switch to **[LOCK]**.

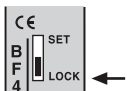

SENSORS

CONTROLLERS

MOTION DEVICES

SOFTWARE

(A) Photoelectric Sensors

(B) Fiber Optic Sensors

(C) LIDAR

(D) Door/Area Sensors

(E) Vision Sensors

(F) Proximity Sensors

(G) Pressure Sensors

(H) Rotary Encoders

(I) Connectors/ Connector Cables/ Sensor Distribution Boxes/ Sockets