



Dual, SiGe, High-Linearity, 1700MHz to 2200MHz Downconversion Mixer with LO Buffer/Switch

MAX19995

General Description

The MAX19995 dual-channel downconverter provides 9dB of conversion gain, +24.8dBm input IP₃, +13.3dBm 1dB input compression point, and a noise figure as low as 9dB for 1700MHz to 2200MHz diversity receiver applications. With an optimized LO frequency range of 1400MHz to 2000MHz, this mixer is ideal for low-side LO injection architectures. High-side LO injection is supported by the MAX19995A, which is pin-pin and functionally compatible with the MAX19995.

In addition to offering excellent linearity and noise performance, the MAX19995 also yields a high level of component integration. This device includes two double-balanced passive mixer cores, two LO buffers, a dual-input LO selectable switch, and a pair of differential IF output amplifiers. Integrated on-chip baluns allow for single-ended RF and LO inputs.

The MAX19995 requires a nominal LO drive of 0dBm and a typical supply current of 297mA at V_{CC} = 5.0V or 212mA at V_{CC} = 3.3V.

The MAX19995/MAX19995A are pin compatible with the MAX19985/MAX19985A series of 700MHz to 1000MHz mixers and pin similar with the MAX19997A/MAX19999 series of 1800MHz to 4000MHz mixers, making this entire family of downconverters ideal for applications where a common PCB layout is used across multiple frequency bands.

The MAX19995 is available in a 6mm x 6mm, 36-pin thin QFN package with an exposed pad. Electrical performance is guaranteed over the extended temperature range, from T_C = -40°C to +85°C.

Applications

UMTS/WCDMA/LTE Base Stations
 cdma2000[®] Base Stations
 DCS1800 and EDGE Base Stations
 PCS1900 and EDGE Base Stations
 PHS/PAS Base Stations
 Fixed Broadband Wireless Access
 Wireless Local Loop
 Private Mobile Radios
 Military Systems

Pin Configuration and Typical Application Circuit appear at end of data sheet.

cdma2000 is a registered trademark of Telecommunications Industry Association.

Features

- ◆ 1700MHz to 2200MHz RF Frequency Range
- ◆ 1400MHz to 2000MHz LO Frequency Range
- ◆ 1750MHz to 2700MHz LO Frequency Range (MAX19995A)
- ◆ 50MHz to 500MHz IF Frequency Range
- ◆ 9dB Typical Conversion Gain
- ◆ 9dB Typical Noise Figure
- ◆ +24.8dBm Typical Input IP₃
- ◆ +13.3dBm Typical Input 1dB Compression Point
- ◆ 79dBc Typical 2RF-2LO Spurious Rejection at P_{RF} = -10dBm
- ◆ Dual Channels Ideal for Diversity Receiver Applications
- ◆ 49dB Typical Channel-to-Channel Isolation
- ◆ Low -3dBm to +3dBm LO Drive
- ◆ Integrated LO Buffer
- ◆ Internal RF and LO Baluns for Single-Ended Inputs
- ◆ Built-In SPDT LO Switch with 56dB LO-to-LO Isolation and 50ns Switching Time
- ◆ Pin Compatible with the MAX19985/MAX19985A/MAX19995A Series of 700MHz to 2200MHz Mixers
- ◆ Pin Similar to the MAX19997A/MAX19999 Series of 1800MHz to 4000MHz Mixers
- ◆ Single +5.0V or +3.3V Supply
- ◆ External Current-Setting Resistors Provide Option for Operating Device in Reduced-Power/Reduced-Performance Mode

Ordering Information

PART	TEMP RANGE	PIN-PACKAGE
MAX19995ETX+	-40°C to +85°C	36 Thin QFN-EP*
MAX19995ETX+T	-40°C to +85°C	36 Thin QFN-EP*

+Denotes a lead(Pb)-free/RoHS-compliant package.

*EP = Exposed pad.

T = Tape and reel.



Dual, SiGe, High-Linearity, 1700MHz to 2200MHz Downconversion Mixer with LO Buffer/Switch

ABSOLUTE MAXIMUM RATINGS

V _{CC} to GND	-0.3V to +5.5V	θ _{JA} (Notes 2, 3)	+38°C/W
LO1, LO2 to GND	±0.3V	θ _{JC} (Notes 1, 3)	7.4°C/W
Any Other Pins to GND	-0.3V to (V _{CC} + 0.3V)	Operating Case Temperature Range (Note 4)	-40°C to +85°C
RFMAIN, RFDIV, and LO_ Input Power	+15dBm	Junction Temperature	+150°C
RFMAIN, RFDIV Current (RF is DC shorted to GND through a balun)	50mA	Storage Temperature Range	-65°C to +150°C
Continuous Power Dissipation (Note 1)	8.7W	Lead Temperature (soldering, 10s)	+300°C

Note 1: Based on junction temperature $T_J = T_C + (\theta_{JC} \times V_{CC} \times I_{CC})$. This formula can be used when the temperature of the exposed pad is known while the device is soldered down to a PCB. See the *Applications Information* section for details. The junction temperature must not exceed +150°C.

Note 2: Junction temperature $T_J = T_A + (\theta_{JA} \times V_{CC} \times I_{CC})$. This formula can be used when the ambient temperature of the PCB is known. The junction temperature must not exceed +150°C.

Note 3: Package thermal resistances were obtained using the method described in JEDEC specification JESD51-7, using a four-layer board. For detailed information on package thermal considerations, refer to www.maxim-ic.com/thermal-tutorial.

Note 4: T_C is the temperature on the exposed pad of the package. T_A is the ambient temperature of the device and PCB.

Stresses beyond those listed under "Absolute Maximum Ratings" may cause permanent damage to the device. These are stress ratings only, and functional operation of the device at these or any other conditions beyond those indicated in the operational sections of the specifications is not implied. Exposure to absolute maximum rating conditions for extended periods may affect device reliability.

+5.0V SUPPLY DC ELECTRICAL CHARACTERISTICS

(Typical Application Circuit optimized for the DCS/PCS band, V_{CC} = +4.75V to +5.25V, T_C = -40°C to +85°C, R1 = R4 = 806Ω, R2 = R5 = 2.32kΩ. Typical values are at V_{CC} = +5.0V, T_C = +25°C, unless otherwise noted. All parameters are production tested.)

PARAMETER	SYMBOL	CONDITIONS	MIN	TYP	MAX	UNITS
Supply Voltage	V _{CC}		4.75	5	5.25	V
Supply Current	I _{CC}	Total supply current, V _{CC} = +5.0V		297	370	mA
LOSEL Input High Voltage	V _{IH}		2			V
LOSEL Input Low Voltage	V _{IL}				0.8	V
LOSEL Input Current	I _{IH} and I _{IL}		-10		+10	μA

+3.3V SUPPLY DC ELECTRICAL CHARACTERISTICS

(Typical Application Circuit, V_{CC} = +3.0V to +3.6V, T_C = -40°C to +85°C, R1 = R4 = 909Ω, R2 = R5 = 2.49kΩ. Typical values are at V_{CC} = +3.3V, T_C = +25°C, unless otherwise noted. All parameters are guaranteed by design and not production tested.)

PARAMETER	SYMBOL	CONDITIONS	MIN	TYP	MAX	UNITS
Supply Voltage	V _{CC}		3.0	3.3	3.6	V
Supply Current	I _{CC}	Total supply current, V _{CC} = +3.3V		212		mA
LOSEL Input High Voltage	V _{IH}			2		V
LOSEL Input Low Voltage	V _{IL}			0.8		V

Dual, SiGe, High-Linearity, 1700MHz to 2200MHz Downconversion Mixer with LO Buffer/Switch

MAX19995

RECOMMENDED AC OPERATING CONDITIONS

PARAMETER	SYMBOL	CONDITIONS	MIN	TYP	MAX	UNITS
RF Frequency	f_{RF}	(Note 5)	1700		2200	MHz
LO Frequency	f_{LO}	(Note 5)	1400		2000	MHz
IF Frequency	f_{IF}	Using Mini-Circuits TC4-1W-17 4:1 transformer as defined in the typical application circuit, IF matching components affect the IF frequency range (Note 5)	100		500	MHz
		Using alternative Mini-Circuits TC4-1W-7A 4:1 transformer, IF matching components affect the IF frequency range (Note 5)	50		250	MHz
LO Drive Level	P_{LO}		-3		+3	dBm

+5.0V SUPPLY AC ELECTRICAL CHARACTERISTICS

(Typical Application Circuit optimized for the DCS/PCS band, $R_1 = R_4 = 806\Omega$, $R_2 = R_5 = 2.32k\Omega$, $V_{CC} = +4.75V$ to $+5.25V$, RF and LO ports are driven from 50Ω sources, $P_{LO} = -3dBm$ to $+3dBm$, $P_{RF} = -5dBm$, $f_{RF} = 1700MHz$ to $2000MHz$, $f_{LO} = 1510MHz$ to $1810MHz$, $f_{IF} = 190MHz$, $f_{RF} > f_{LO}$, $T_C = -40^\circ C$ to $+85^\circ C$. Typical values are at $V_{CC} = +5.0V$, $P_{RF} = -5dBm$, $P_{LO} = 0dBm$, $f_{RF} = 1800MHz$, $f_{LO} = 1610MHz$, $f_{IF} = 190MHz$, $T_C = +25^\circ C$, unless otherwise noted.) (Note 6)

PARAMETER	SYMBOL	CONDITIONS	MIN	TYP	MAX	UNITS
Conversion Gain	G_C		7	9	11	dB
		$T_C = +25^\circ C$	7.8	9	10.2	
		Typical Application Circuit optimized for UMTS band ($R_1 = R_4 = 681\Omega$, $R_2 = R_5 = 1.5k\Omega$), $f_{LO} = 1760MHz$, $f_{RF} = 1950MHz$		8.9		
Conversion Gain Flatness		Flatness over any one of three frequency bands: $f_{RF} = 1710MHz$ to $1785MHz$ $f_{RF} = 1850MHz$ to $1910MHz$ $f_{RF} = 1920MHz$ to $1980MHz$		± 0.1		dB
Gain Variation Over Temperature	T_{CCG}	$f_{RF} = 1700MHz$ to $2000MHz$, $f_{LO} = 1510MHz$ to $1810MHz$, $f_{IF} = 190MHz$, $T_C = -40^\circ C$ to $+85^\circ C$		-0.009		dB/ $^\circ C$
Input Compression Point (Note 7)	IP_{1dB}	$f_{RF} = 1700MHz$ for min value	9.5	12.5		dBm
		Typical Application Circuit optimized for UMTS band ($R_1 = R_4 = 681\Omega$, $R_2 = R_5 = 1.5k\Omega$), $f_{LO} = 1760MHz$, $f_{IF} = 190MHz$, $f_{RF} = 1950MHz$		13.3		

Dual, SiGe, High-Linearity, 1700MHz to 2200MHz Downconversion Mixer with LO Buffer/Switch

+5.0V SUPPLY AC ELECTRICAL CHARACTERISTICS (continued)

(Typical Application Circuit optimized for the DCS/PCS band, $R1 = R4 = 806\Omega$, $R2 = R5 = 2.32k\Omega$, $V_{CC} = +4.75V$ to $+5.25V$, RF and LO ports are driven from 50Ω sources, $P_{LO} = -3dBm$ to $+3dBm$, $P_{RF} = -5dBm$, $f_{RF} = 1700MHz$ to $2000MHz$, $f_{LO} = 1510MHz$ to $1810MHz$, $f_{IF} = 190MHz$, $f_{RF} > f_{LO}$, $T_C = -40^\circ C$ to $+85^\circ C$. Typical values are at $V_{CC} = +5.0V$, $P_{RF} = -5dBm$, $P_{LO} = 0dBm$, $f_{RF} = 1800MHz$, $f_{LO} = 1610MHz$, $f_{IF} = 190MHz$, $T_C = +25^\circ C$, unless otherwise noted.) (Note 6)

PARAMETER	SYMBOL	CONDITIONS	MIN	TYP	MAX	UNITS
Input Intercept Point	IIP3	$f_{RF1} - f_{RF2} = 1MHz$, $P_{RF} = -5dBm$ per tone, $f_{RF} = 2000MHz$ for min value	20.5	23.7		dBm
		$f_{IF} = 190MHz$, $f_{LO} = 1810MHz$, $f_{RF} = 2000MHz$ for min value, $f_{RF1} - f_{RF2} = 1MHz$, $P_{RF} = -5dBm$ per tone, $T_C = +25^\circ C$ to $+85^\circ C$	21.5	23.7		
		Typical Application Circuit optimized for UMTS band ($R1 = R4 = 681\Omega$, $R2 = R5 = 1.5k\Omega$), $f_{LO} = 1760MHz$, $f_{IF} = 190MHz$, $f_{RF} = 1950MHz$, $f_{RF1} - f_{RF2} = 1MHz$, $P_{RF} = -5dBm$ per tone		24.8		
Input Intercept Variation Over Temperature	TC_{IIP3}	$f_{RF1} - f_{RF2} = 1MHz$, $P_{RF} = -5dBm$ per tone, $T_C = -40^\circ C$ to $+85^\circ C$		0.0035		dBm/ $^\circ C$
Noise Figure	NF_{SSB}	Single sideband, no blockers present (Note 8)		9	11	dB
		$f_{LO} = 1610MHz$, $f_{IF} = 190MHz$, $f_{RF} = 1800MHz$, $T_C = +25^\circ C$, $P_{LO} = 0dBm$, single sideband, no blockers present (Note 8)		9	9.6	
		Typical Application Circuit optimized for UMTS band ($R1 = R4 = 681\Omega$, $R2 = R5 = 1.5k\Omega$), $f_{IF} = 190MHz$, $f_{LO} = 1760MHz$, $f_{RF} = 1950MHz$, single sideband, no blockers present		9.3		
Noise Figure Temperature Coefficient	TC_{NF}	Single sideband, no blockers present, $T_C = -40^\circ C$ to $+85^\circ C$		0.016		dB/ $^\circ C$
Noise Figure with Blocker	NF_B	$f_{BLOCKER} = 1900MHz$, $P_{BLOCKER} = +8dBm$, $f_{RF} = 1800MHz$, $f_{LO} = 1610MHz$, $P_{LO} = 0dBm$, $V_{CC} = +5.0V$, $T_C = +25^\circ C$ (Notes 8, 9)		19	20.5	dB

Dual, SiGe, High-Linearity, 1700MHz to 2200MHz Downconversion Mixer with LO Buffer/Switch

MAX19995

+5.0V SUPPLY AC ELECTRICAL CHARACTERISTICS (continued)

(Typical Application Circuit optimized for the DCS/PCS band, R1 = R4 = 806Ω, R2 = R5 = 2.32kΩ, VCC = +4.75V to +5.25V, RF and LO ports are driven from 50Ω sources, PLO = -3dBm to +3dBm, PRF = -5dBm, fRF = 1700MHz to 2000MHz, fLO = 1510MHz to 1810MHz, fIF = 190MHz, fRF > fLO, TC = -40°C to +85°C. Typical values are at VCC = +5.0V, PRF = -5dBm, PLO = 0dBm, fRF = 1800MHz, fLO = 1610MHz, fIF = 190MHz, TC = +25°C, unless otherwise noted.) (Note 6)

PARAMETER	SYMBOL	CONDITIONS	MIN	TYP	MAX	UNITS
2RF-2LO Spur Rejection	2 x 2	fRF = 1800MHz, fLO = 1610MHz, PRF = -10dBm (Note 8)	54	79		dBc
		fRF = 1800MHz, fLO = 1610MHz, PRF = -5dBm (Note 8)	49	74		
		fRF = 1800MHz, fLO = 1610MHz, PLO = 0dBm, PRF = -10dBm, VCC = +5.0V, TC = +25°C (Note 8)	56	79		
		fRF = 1800MHz, fLO = 1610MHz, PLO = 0dBm, PRF = -5dBm, VCC = +5.0V, TC = +25°C (Note 8)	51	74		
		Typical Application Circuit optimized for UMTS band (R1 = R4 = 681Ω, R2 = R5 = 1.5kΩ), fIF = 190MHz, fLO = 1760MHz, fRF = 1950MHz, PRF = -10dBm		79		
		Typical Application Circuit optimized for UMTS band (R1 = R4 = 681Ω, R2 = R5 = 1.5kΩ), fIF = 190MHz, fLO = 1760MHz, fRF = 1950MHz, PRF = -5dBm		74		
3RF-3LO Spur Rejection	3 x 3	fRF = 1800MHz, fLO = 1610MHz, PRF = -10dBm (Note 8)	77	91		dBc
		fRF = 1800MHz, fLO = 1610MHz, PRF = -5dBm (Note 8)	67	81		
		fRF = 1800MHz, fLO = 1610MHz, PLO = 0dBm, PRF = -10dBm, VCC = +5.0V, TC = +25°C (Note 8)	79	91		
		fRF = 1800MHz, fLO = 1600MHz, PLO = 0dBm, PRF = -5dBm, VCC = +5.0V, TC = +25°C (Note 8)	69	81		
		Typical Application Circuit optimized for UMTS band (R1 = R4 = 681Ω, R2 = R5 = 1.5kΩ), fIF = 190MHz, fLO = 1760MHz, fRF = 1950MHz, PRF = -10dBm		86		
		Typical Application Circuit optimized for UMTS band (R1 = R4 = 681Ω, R2 = R5 = 1.5kΩ), fIF = 190MHz, fLO = 1760MHz, fRF = 1950MHz, PRF = -5dBm		76		

Dual, SiGe, High-Linearity, 1700MHz to 2200MHz Downconversion Mixer with LO Buffer/Switch

+5.0V SUPPLY AC ELECTRICAL CHARACTERISTICS (continued)

(Typical Application Circuit optimized for the DCS/PCS band, $R_1 = R_4 = 806\Omega$, $R_2 = R_5 = 2.32k\Omega$, $V_{CC} = +4.75V$ to $+5.25V$, RF and LO ports are driven from 50Ω sources, $P_{LO} = -3dBm$ to $+3dBm$, $PRF = -5dBm$, $f_{RF} = 1700MHz$ to $2000MHz$, $f_{LO} = 1510MHz$ to $1810MHz$, $f_{IF} = 190MHz$, $f_{RF} > f_{LO}$, $T_C = -40^\circ C$ to $+85^\circ C$. Typical values are at $V_{CC} = +5.0V$, $PRF = -5dBm$, $P_{LO} = 0dBm$, $f_{RF} = 1800MHz$, $f_{LO} = 1610MHz$, $f_{IF} = 190MHz$, $T_C = +25^\circ C$, unless otherwise noted.) (Note 6)

PARAMETER	SYMBOL	CONDITIONS	MIN	TYP	MAX	UNITS
RF Input Return Loss		LO and IF terminated into matched impedance, LO on		21		dB
LO Input Return Loss		LO port selected, RF and IF terminated into matched impedance		20		dB
		LO port unselected, RF and IF terminated into matched impedance		19		
IF Output Impedance	Z_{IF}	Nominal differential impedance of the IC's IF outputs		200		Ω
IF Return Loss		RF terminated into 50Ω , LO driven by 50Ω source, IF transformed to 50Ω using external components shown in <i>Typical Application Circuit</i>		12.5		dB
RF-to-IF Isolation		$f_{RF} = 1700MHz$ for min value	30	39		dB
LO Leakage at RF Port		(Notes 8, 10)		-31	-24.7	dBm
2LO Leakage at RF Port		(Note 8)		-20	-16	dBm
LO Leakage at IF Port		(Note 8)		-40	-27	dBm
Channel Isolation		RFMAIN converted power measured at IFD_, relative to IFM_, all unused ports terminated to 50Ω	40	49		dB
		RFDIV converted power measured at IFM_, relative to IFD_, all unused ports terminated to 50Ω	40	49		
LO-to-LO Isolation		$P_{LO1} = +3dBm$, $P_{LO2} = +3dBm$, $f_{LO1} = 1610MHz$, $f_{LO2} = 1611MHz$	40	56		dB
LO Switching Time		50% of LOSEL to IF settled within 2 degrees		50		ns

+3.3V SUPPLY AC ELECTRICAL CHARACTERISTICS

(Typical Application Circuit. Typical values are at $V_{CC} = +3.3V$, $PRF = -5dBm$, $P_{LO} = 0dBm$, $f_{RF} = 1800MHz$, $f_{LO} = 1610MHz$, $f_{IF} = 190MHz$, $T_C = +25^\circ C$, unless otherwise noted.) (Note 6)

PARAMETER	SYMBOL	CONDITIONS	MIN	TYP	MAX	UNITS
Conversion Gain	G_C			8.4		dB
Conversion Gain Flatness		Flatness over any one of three frequency bands: $f_{RF} = 1710MHz$ to $1785MHz$ $f_{RF} = 1850MHz$ to $1910MHz$ $f_{RF} = 1920MHz$ to $1980MHz$		± 0.1		dB
Gain Variation Over Temperature	T_{CCG}	$T_C = -40^\circ C$ to $+85^\circ C$		-0.009		dB/ $^\circ C$

Dual, SiGe, High-Linearity, 1700MHz to 2200MHz Downconversion Mixer with LO Buffer/Switch

MAX19995

+3.3V SUPPLY AC ELECTRICAL CHARACTERISTICS (continued)

(Typical Application Circuit. Typical values are at $V_{CC} = +3.3V$, $P_{RF} = -5dBm$, $P_{LO} = 0dBm$, $f_{RF} = 1800MHz$, $f_{LO} = 1610MHz$, $f_{IF} = 190MHz$, $T_C = +25^\circ C$, unless otherwise noted.) (Note 6)

PARAMETER	SYMBOL	CONDITIONS	MIN	TYP	MAX	UNITS
Input Compression Point	IP _{1dB}	(Note 7)		8.9		dBm
Input Intercept Point	IIP ₃	$f_{RF1} - f_{RF2} = 1MHz$		18.5		dBm
Input Intercept Variation Over Temperature	TC _{IIP3}	$f_{RF1} - f_{RF2} = 1MHz$, $T_C = -40^\circ C$ to $+85^\circ C$		0.0034		dBm/ $^\circ C$
Noise Figure	NF _{SSB}	Single sideband, no blockers present		9.0		dB
Noise Figure Temperature Coefficient	TC _{NF}	Single sideband, no blockers present, $T_C = -40^\circ C$ to $+85^\circ C$		0.016		dB/ $^\circ C$
2RF-2LO Spur Rejection	2 x 2	$P_{RF} = -10dBm$		73		dBc
		$P_{RF} = -5dBm$		68		
3RF-3LO Spur Rejection	3 x 3	$P_{RF} = -10dBm$		70		dBc
		$P_{RF} = -5dBm$		60		
RF Input Return Loss		LO on and IF terminated		21		dB
LO Input Return Loss		LO port selected, RF and IF terminated into matched impedance		16		dB
		LO port unselected, RF and IF terminated into matched impedance		20		
IF Return Loss		RF terminated into 50Ω , LO driven by 50Ω source, IF transformed to 50Ω using external components shown in <i>Typical Application Circuit</i> , $f_{IF} = 190MHz$		12.5		dB
RF-to-IF Isolation				42		dB
LO Leakage at RF Port				-40		dBm
2LO Leakage at RF Port				-29		dBm
LO Leakage at IF Port				-43		dBm
Channel Isolation		RFMAIN converted power measured at IFD ₋ , relative to IFM ₋ , all unused ports terminated to 50Ω		49		dB
		RFDIV converted power measured at IFM ₋ , relative to IFD ₋ , all unused ports terminated to 50Ω		49		
LO-to-LO Isolation		$P_{LO1} = +3dBm$, $P_{LO2} = +3dBm$, $f_{LO1} = 1610MHz$, $f_{LO2} = 1611MHz$		55		dB
LO Switching Time		50% of LOSEL to IF settled within 2 degrees		50		ns

Note 5: Not production tested. Operation outside this range is possible, but with degraded performance of some parameters. See the *Typical Operating Characteristics*.

Note 6: All limits reflect losses of external components, including a 0.65dB loss at $f_{IF} = 190MHz$ due to the 4:1 impedance transformer. Output measurements were taken at IF outputs of the *Typical Application Circuit*.

Note 7: Maximum reliable continuous input power applied to the RF or IF port of this device is +12dBm from a 50Ω source.

Note 8: Guaranteed by design and characterization.

Note 9: Measured with external LO source noise filtered so the noise floor is -174dBm/Hz. This specification reflects the effects of all SNR degradations in the mixer, including the LO noise as defined in Application Note 2021: *Specifications and Measurement of Local Oscillator Noise in Integrated Circuit Base Station Mixers*.

Note 10: Limited production testing.

Dual, SiGe, High-Linearity, 1700MHz to 2200MHz Downconversion Mixer with LO Buffer/Switch

Typical Operating Characteristics

(Typical Application Circuit, optimized for the DCS/PCS band, $R1 = R4 = 806\Omega$, $R2 = R5 = 2.32k\Omega$, $V_{CC} = +5.0V$, $P_{LO} = 0dBm$, $P_{RF} = -5dBm$, LO is low-side injected for a 190MHz IF, $T_C = +25^\circ C$, unless otherwise noted.)

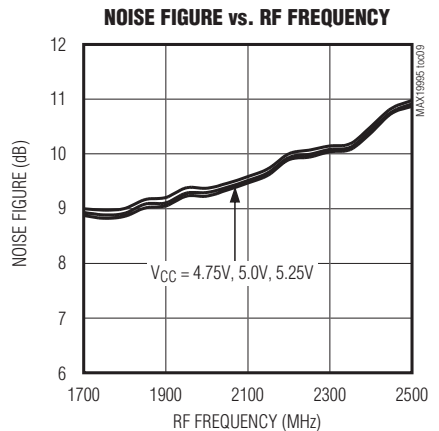
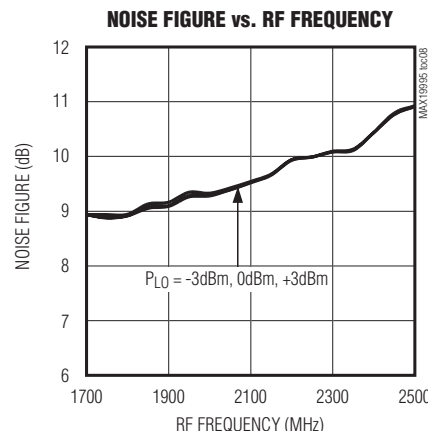
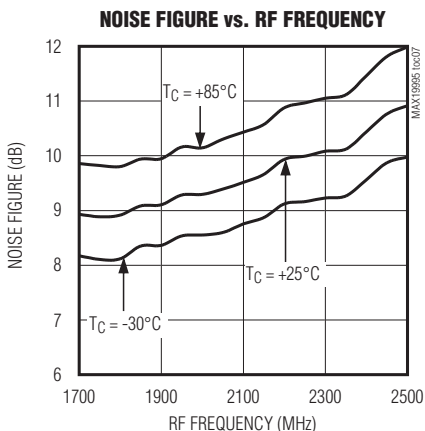
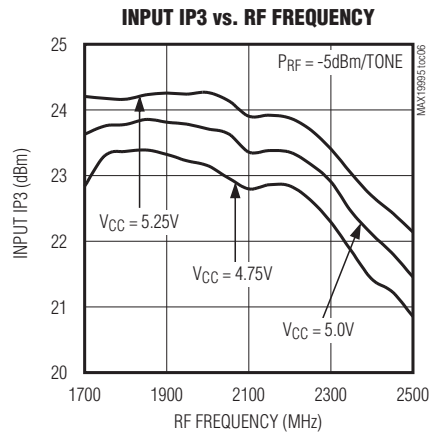
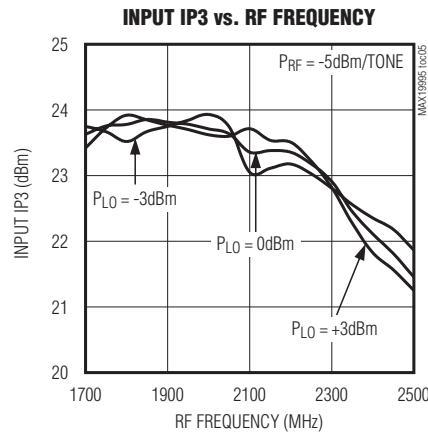
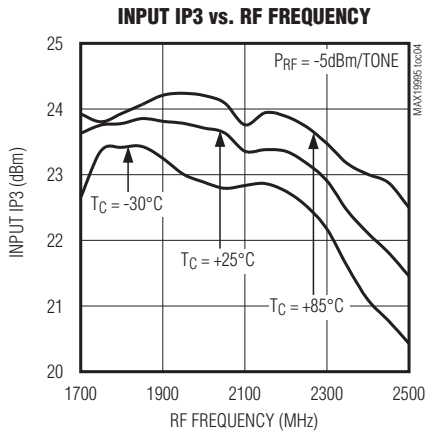
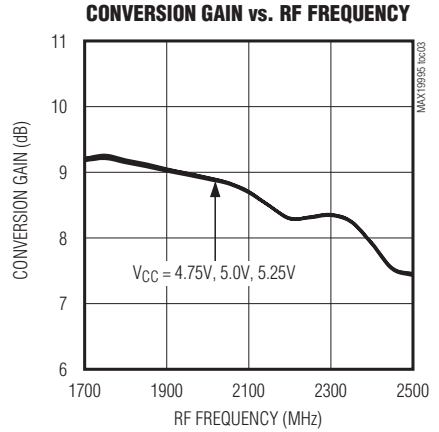
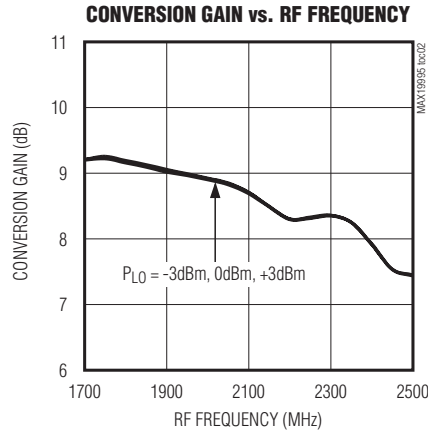
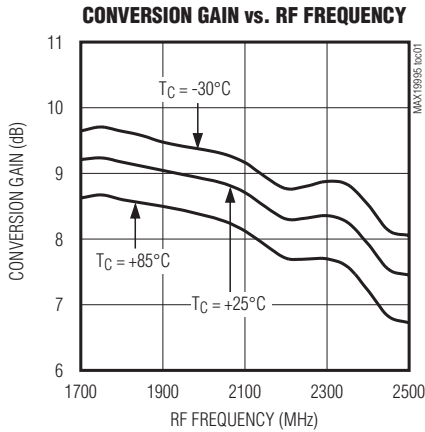

Dual, SiGe, High-Linearity, 1700MHz to 2200MHz Downconversion Mixer with LO Buffer/Switch

Typical Operating Characteristics (continued)

(Typical Application Circuit, optimized for the DCS/PCS band, $R1 = R4 = 806\Omega$, $R2 = R5 = 2.32k\Omega$, $V_{CC} = +5.0V$, $P_{LO} = 0dBm$, $P_{RF} = -5dBm$, LO is low-side injected for a 190MHz IF, $T_C = +25^\circ C$, unless otherwise noted.)

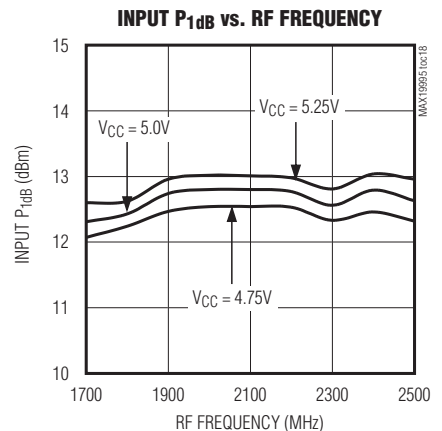
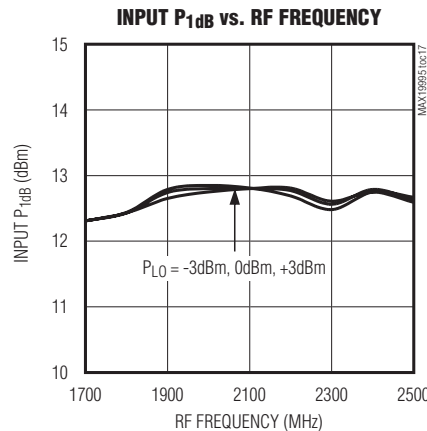
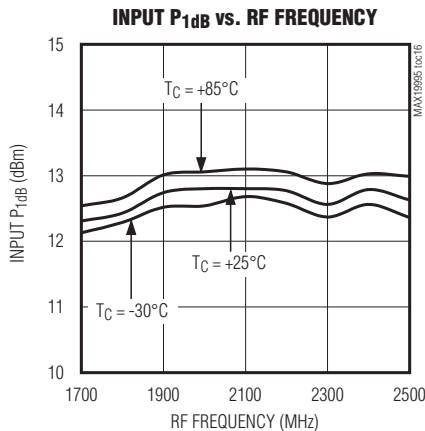
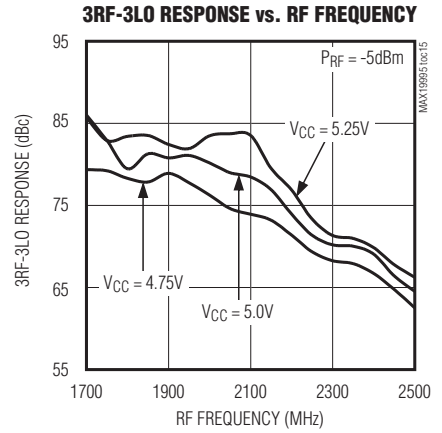
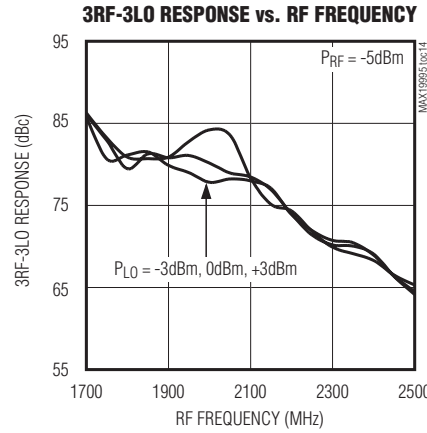
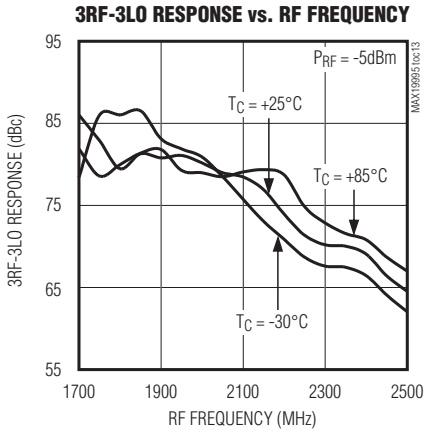
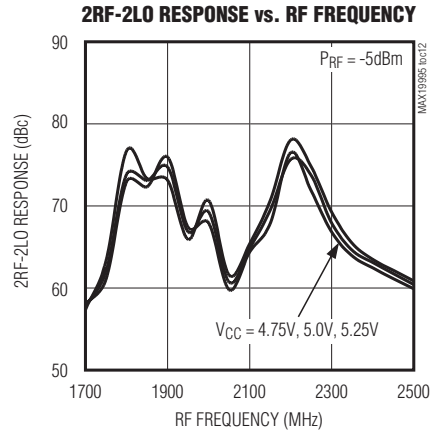
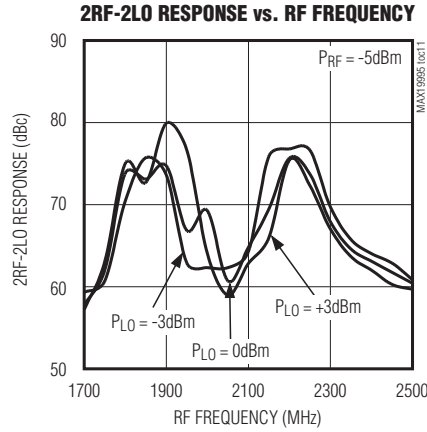
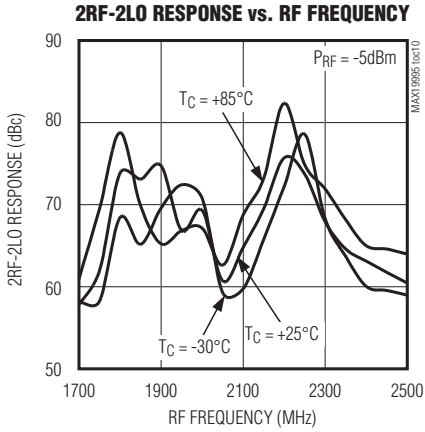

Dual, SiGe, High-Linearity, 1700MHz to 2200MHz Downconversion Mixer with LO Buffer/Switch

Typical Operating Characteristics (continued)

(Typical Application Circuit, optimized for the DCS/PCS band, $R_1 = R_4 = 806\Omega$, $R_2 = R_5 = 2.32k\Omega$, $V_{CC} = +5.0V$, $P_{LO} = 0dBm$, $P_{RF} = -5dBm$, LO is low-side injected for a 190MHz IF, $T_C = +25^\circ C$, unless otherwise noted.)

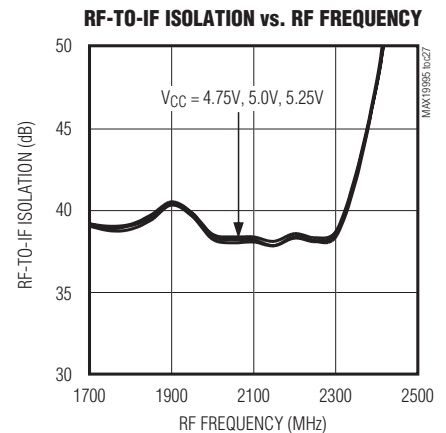
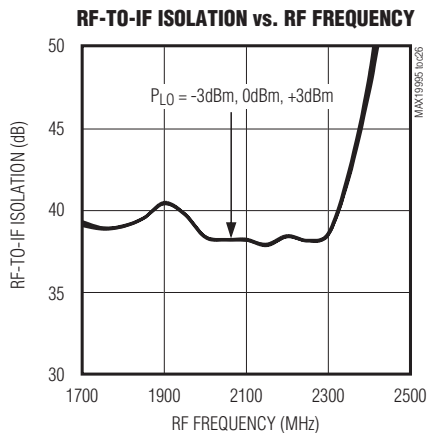
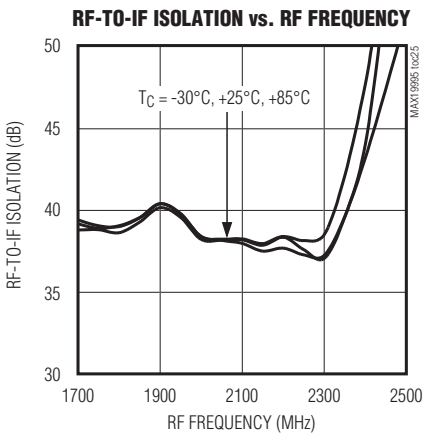
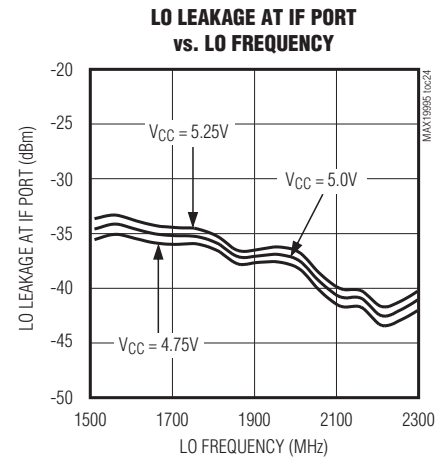
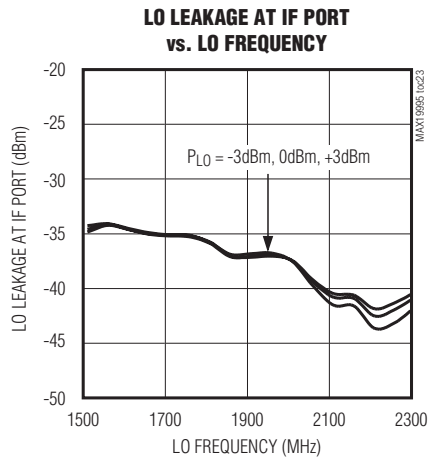
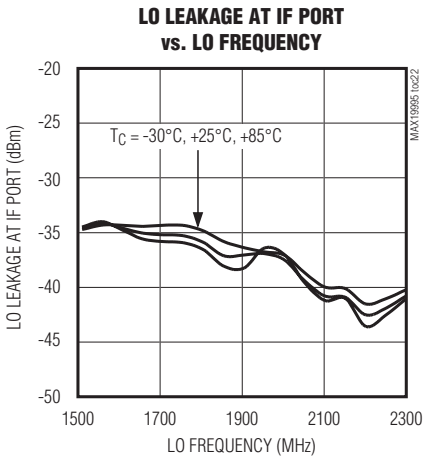
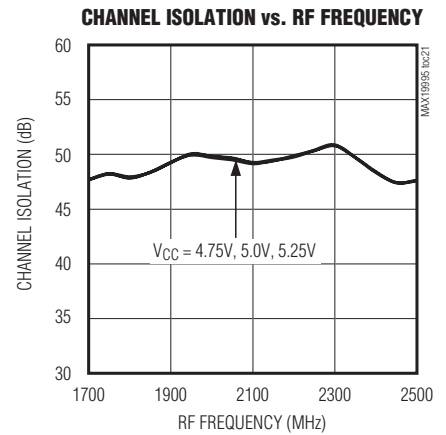
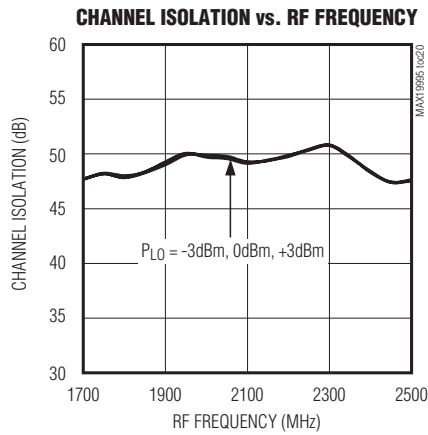
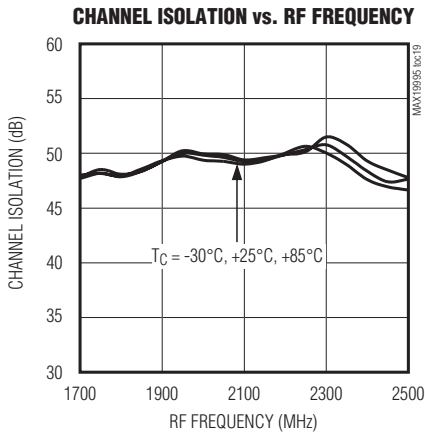

Dual, SiGe, High-Linearity, 1700MHz to 2200MHz Downconversion Mixer with LO Buffer/Switch

Typical Operating Characteristics (continued)

(Typical Application Circuit, optimized for the DCS/PCS band, $R1 = R4 = 806\Omega$, $R2 = R5 = 2.32k\Omega$, $V_{CC} = +5.0V$, $P_{LO} = 0dBm$, $P_{RF} = -5dBm$, LO is low-side injected for a 190MHz IF, $T_C = +25^\circ C$, unless otherwise noted.)

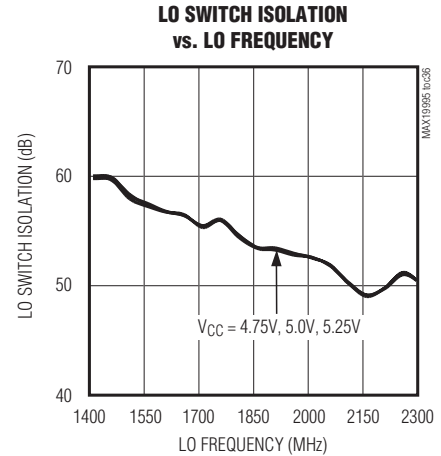
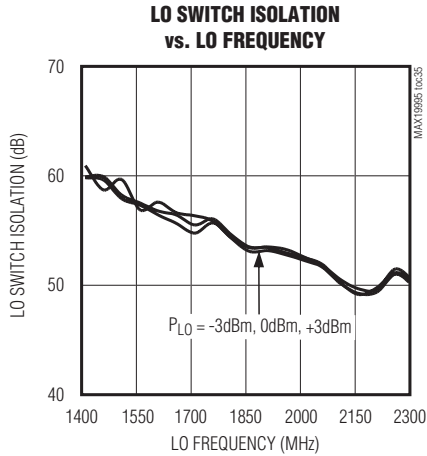
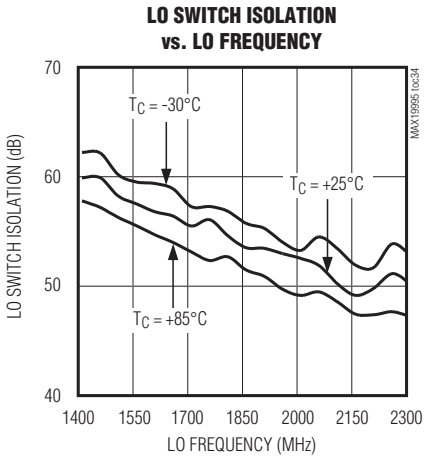
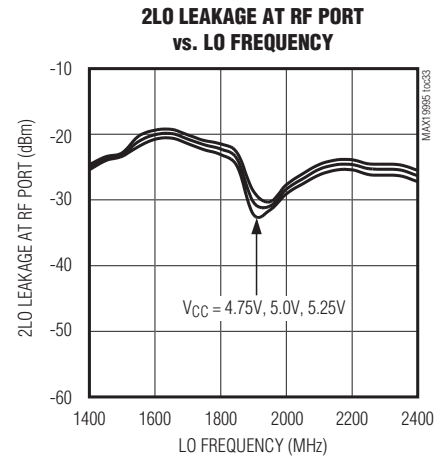
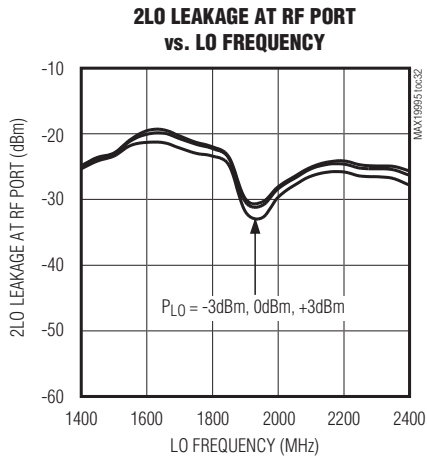
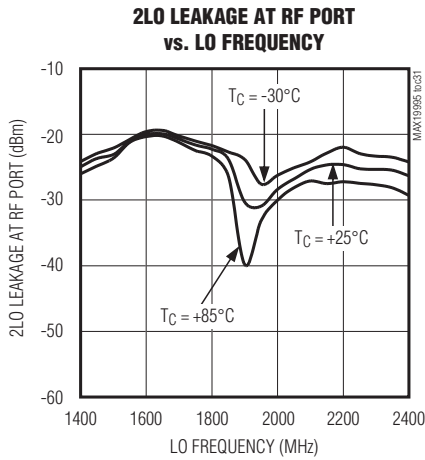
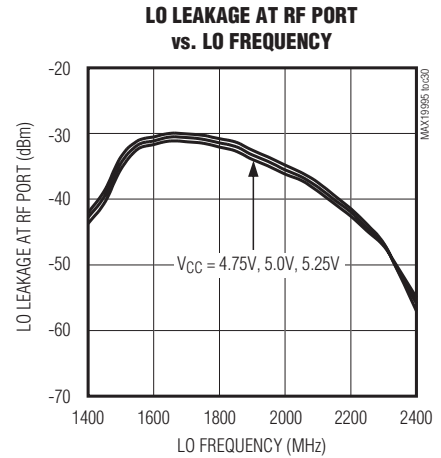
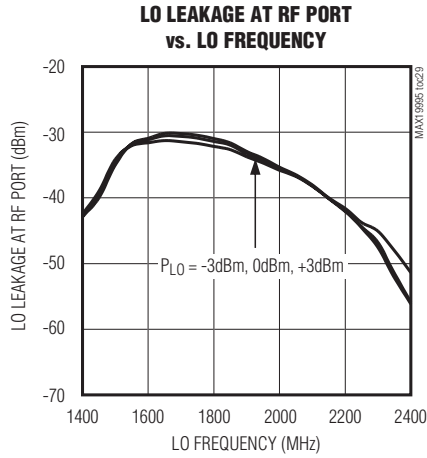
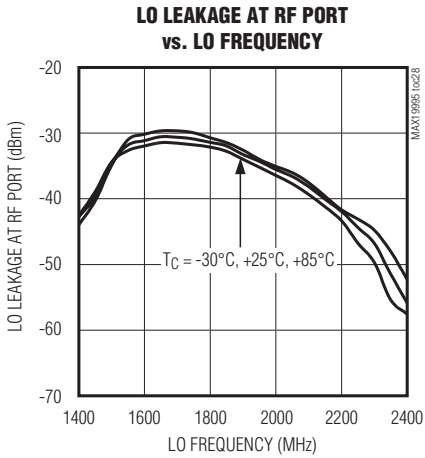

Dual, SiGe, High-Linearity, 1700MHz to 2200MHz Downconversion Mixer with LO Buffer/Switch

Typical Operating Characteristics (continued)

(Typical Application Circuit, optimized for the DCS/PCS band, $R_1 = R_4 = 806\Omega$, $R_2 = R_5 = 2.32k\Omega$, $V_{CC} = +5.0V$, $P_{LO} = 0dBm$, $P_{RF} = -5dBm$, LO is low-side injected for a 190MHz IF, $T_C = +25^\circ C$, unless otherwise noted.)

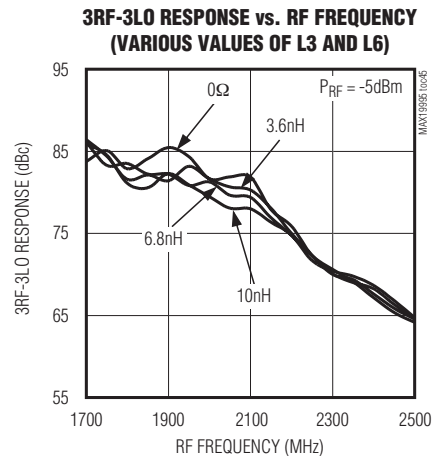
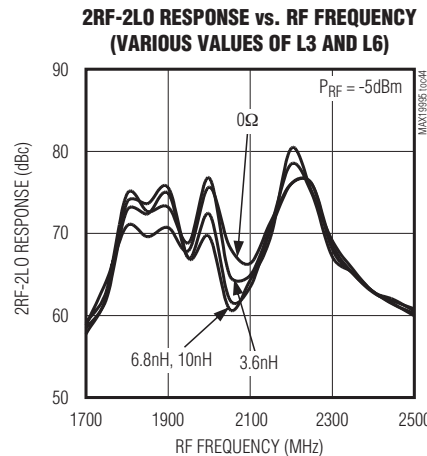
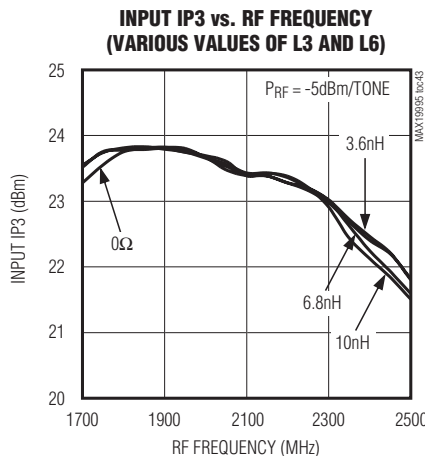
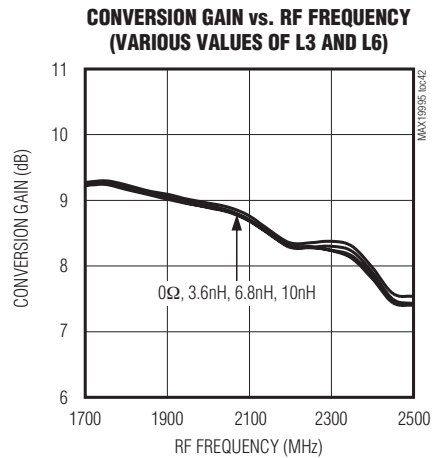
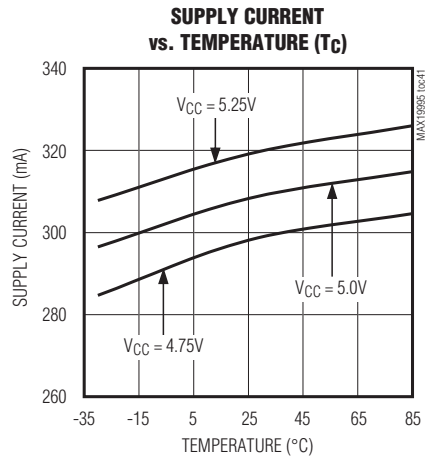
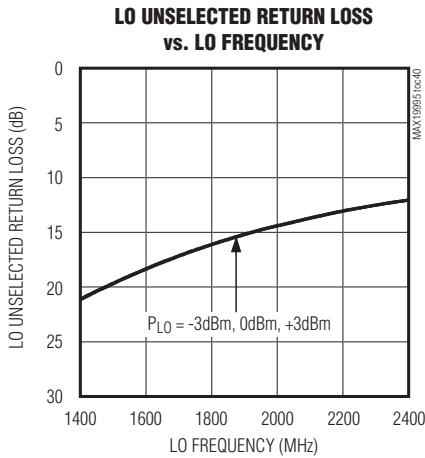
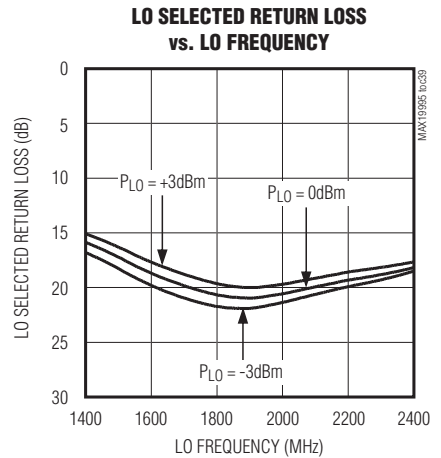
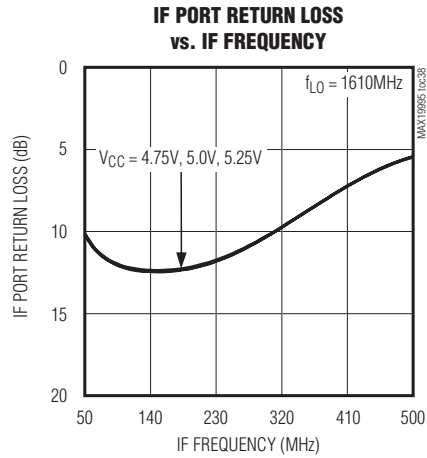
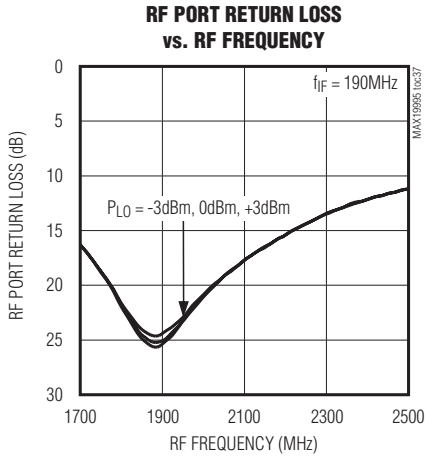

Dual, SiGe, High-Linearity, 1700MHz to 2200MHz Downconversion Mixer with LO Buffer/Switch

Typical Operating Characteristics (continued)

(Typical Application Circuit, optimized for the DCS/PCS band, $R1 = R4 = 806\Omega$, $R2 = R5 = 2.32k\Omega$, $V_{CC} = +5.0V$, $P_{LO} = 0dBm$, $P_{RF} = -5dBm$, LO is low-side injected for a 190MHz IF, $T_C = +25^\circ C$, unless otherwise noted.)

MAX19995

**CHANNEL ISOLATION vs. RF FREQUENCY
(VARIOUS VALUES OF L3 AND L6)**

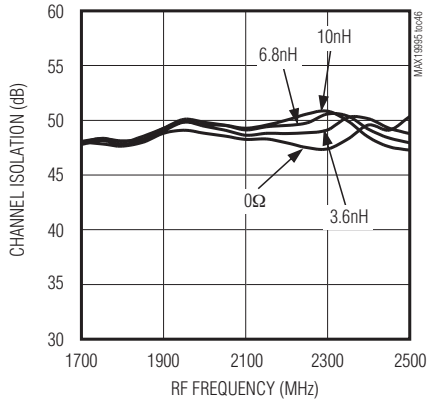

**LO LEAKAGE AT IF PORT vs. LO FREQUENCY
(VARIOUS VALUES OF L3 AND L6)**

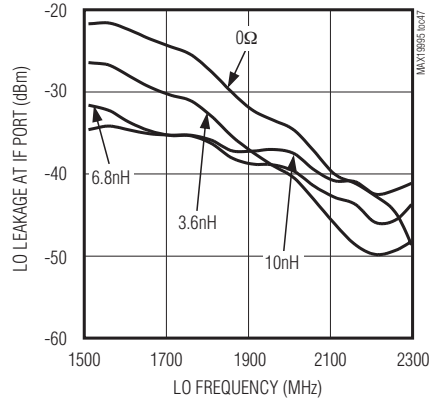

**RF-TO-IF ISOLATION vs. RF FREQUENCY
(VARIOUS VALUES OF L3 AND L6)**

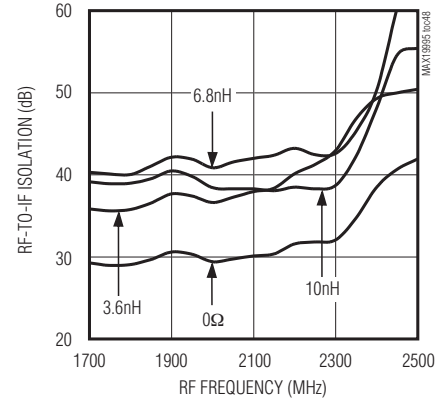

Dual, SiGe, High-Linearity, 1700MHz to 2200MHz Downconversion Mixer with LO Buffer/Switch

Typical Operating Characteristics (continued)

(Typical Application Circuit, optimized for the UMTS band, $R1 = R4 = 681\Omega$, $R2 = R5 = 1.5k\Omega$, $V_{CC} = +5.0V$, $P_{LO} = 0dBm$, $P_{RF} = -5dBm$, LO is low-side injected for a 190MHz IF, $T_C = +25^\circ C$, unless otherwise noted.)

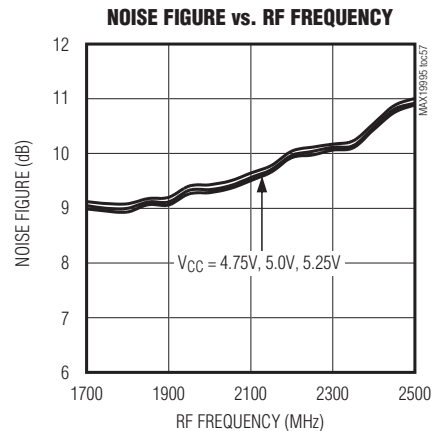
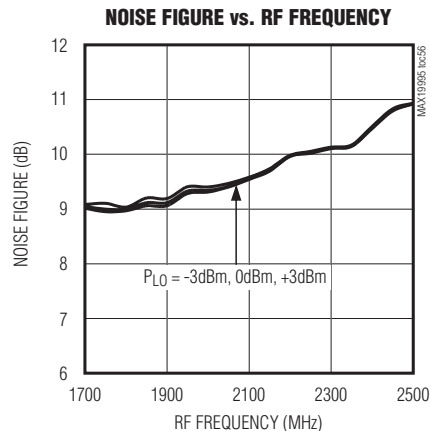
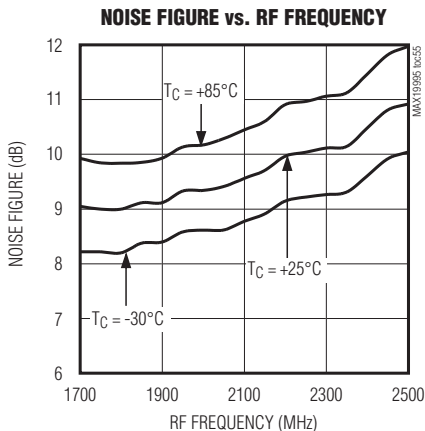
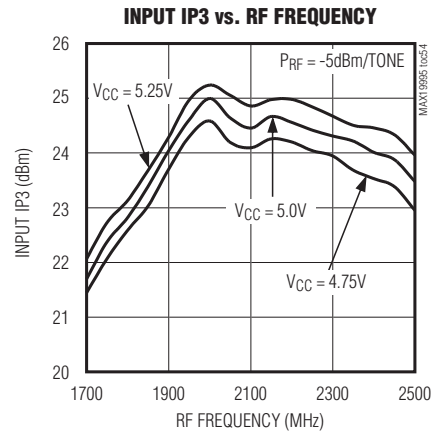
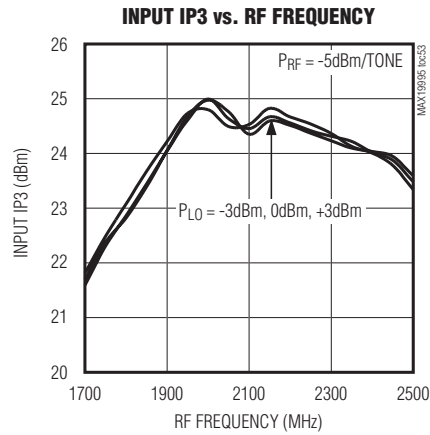
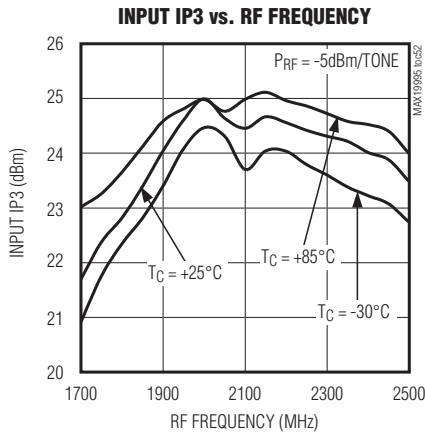
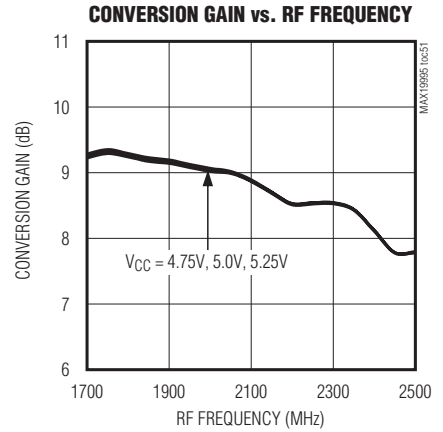
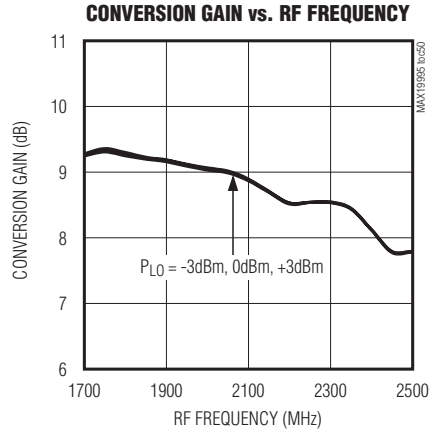
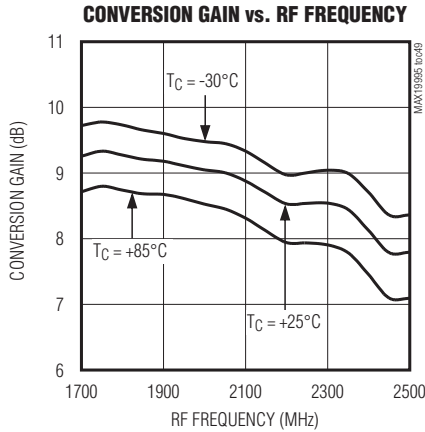

Dual, SiGe, High-Linearity, 1700MHz to 2200MHz Downconversion Mixer with LO Buffer/Switch

Typical Operating Characteristics (continued)

(Typical Application Circuit, optimized for the UMTS band, $R1 = R4 = 681\Omega$, $R2 = R5 = 1.5k\Omega$, $V_{CC} = +5.0V$, $P_{LO} = 0dBm$, $P_{RF} = -5dBm$, LO is low-side injected for a 190MHz IF, $T_C = +25^\circ C$, unless otherwise noted.)

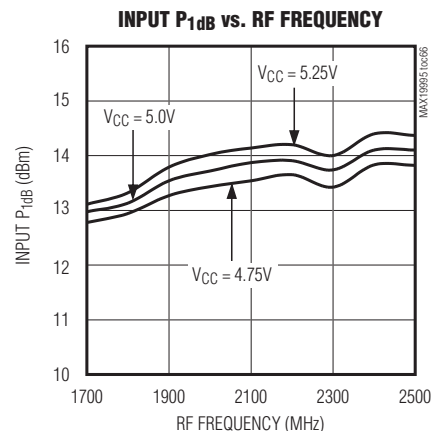
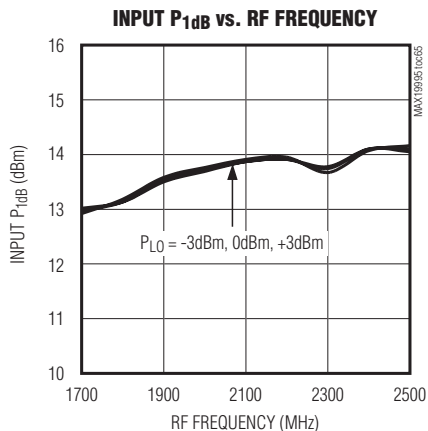
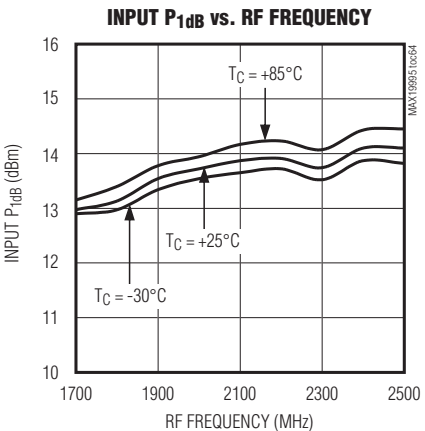
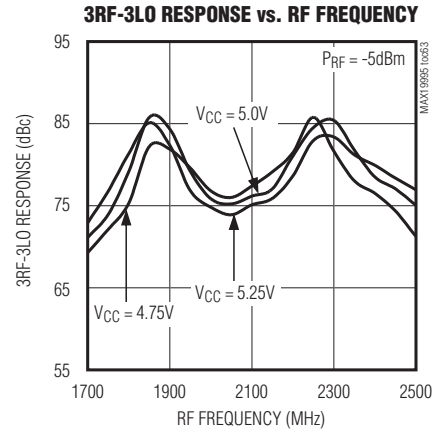
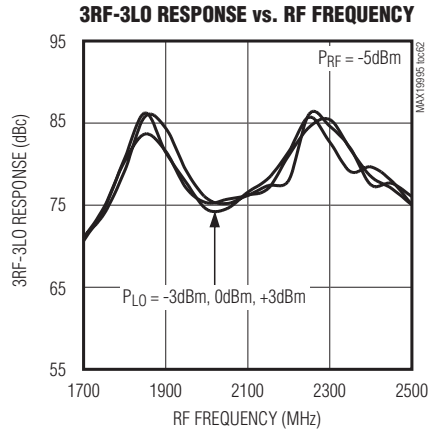
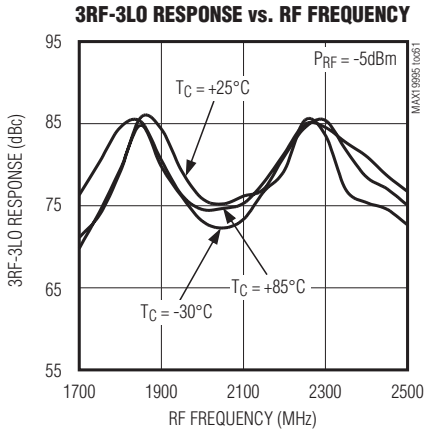
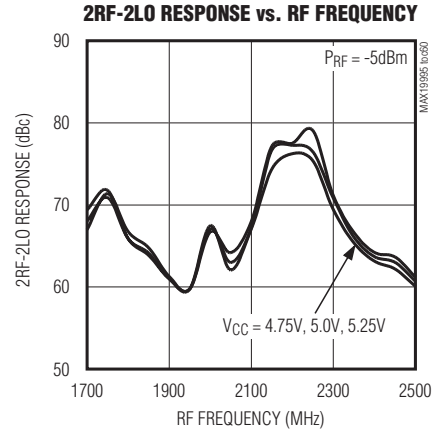
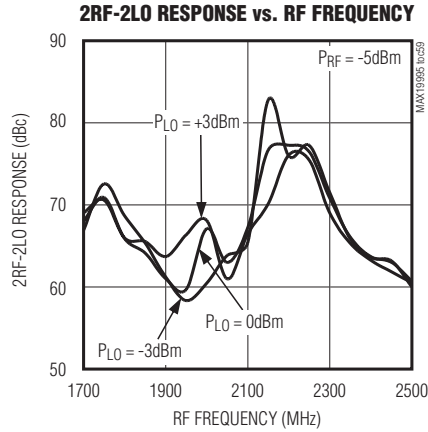
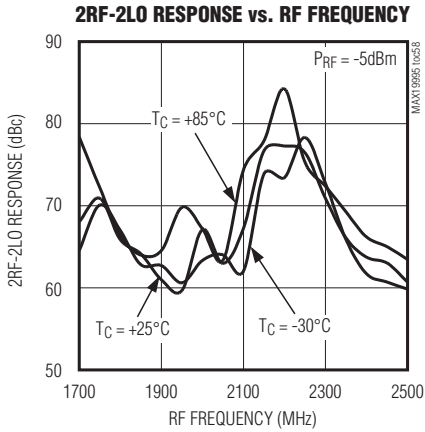

Dual, SiGe, High-Linearity, 1700MHz to 2200MHz Downconversion Mixer with LO Buffer/Switch

Typical Operating Characteristics (continued)

(Typical Application Circuit, optimized for the UMTS band, $R1 = R4 = 681\Omega$, $R2 = R5 = 1.5k\Omega$, $V_{CC} = +5.0V$, $P_{LO} = 0dBm$, $P_{RF} = -5dBm$, LO is low-side injected for a 190MHz IF, $T_C = +25^\circ C$, unless otherwise noted.)

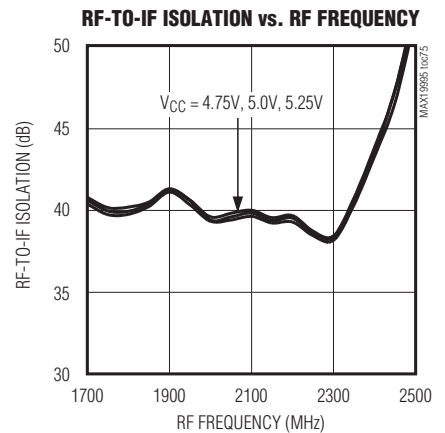
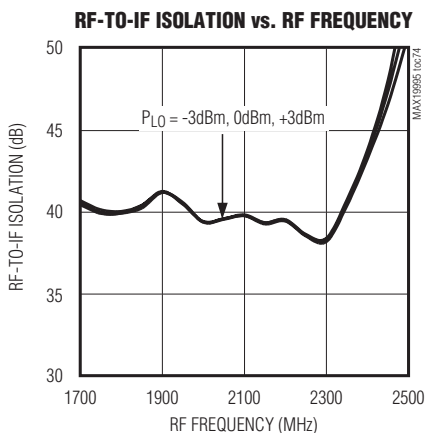
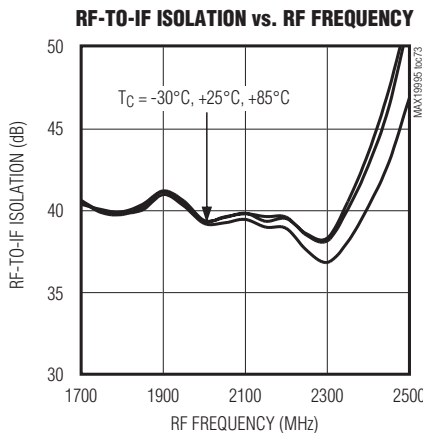
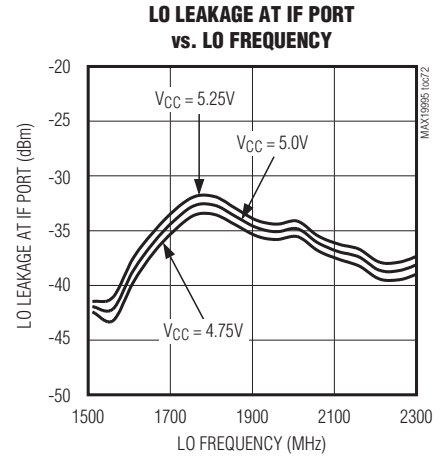
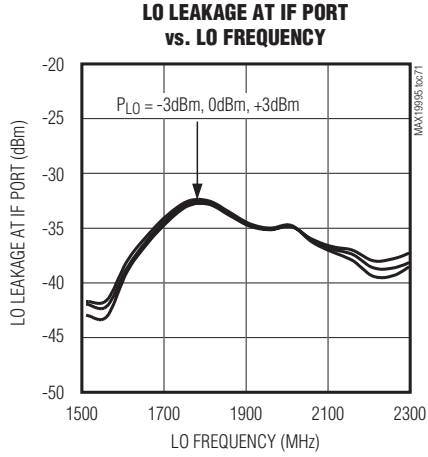
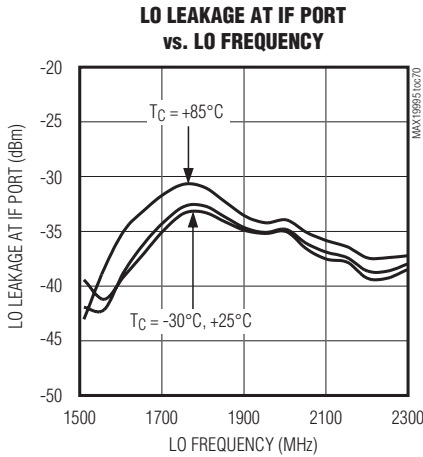
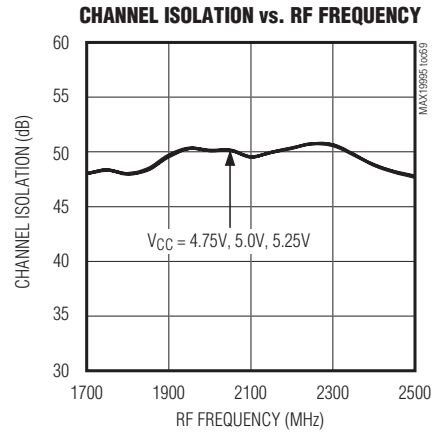
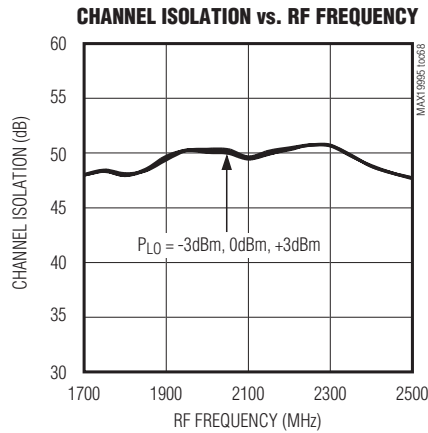
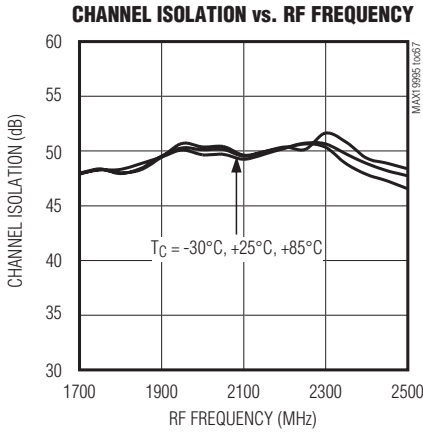

Dual, SiGe, High-Linearity, 1700MHz to 2200MHz Downconversion Mixer with LO Buffer/Switch

Typical Operating Characteristics (continued)

(Typical Application Circuit, optimized for the UMTS band, $R1 = R4 = 681\Omega$, $R2 = R5 = 1.5k\Omega$, $V_{CC} = +5.0V$, $P_{LO} = 0dBm$, $P_{RF} = -5dBm$, LO is low-side injected for a 190MHz IF, $T_C = +25^\circ C$, unless otherwise noted.)

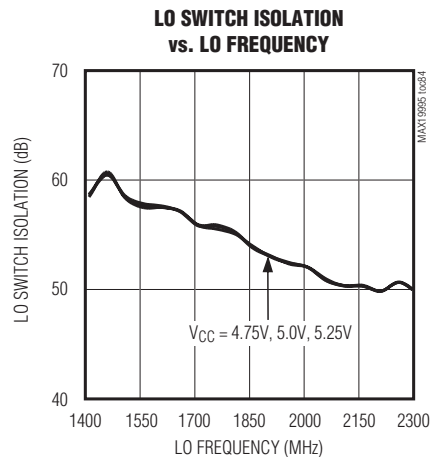
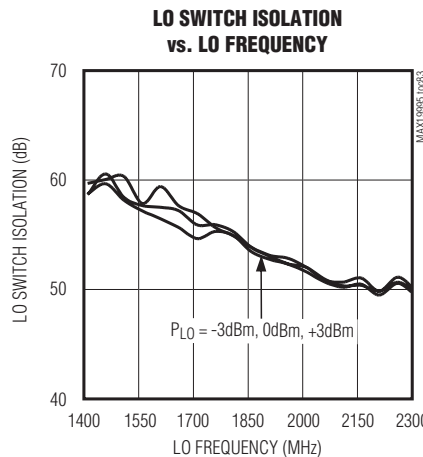
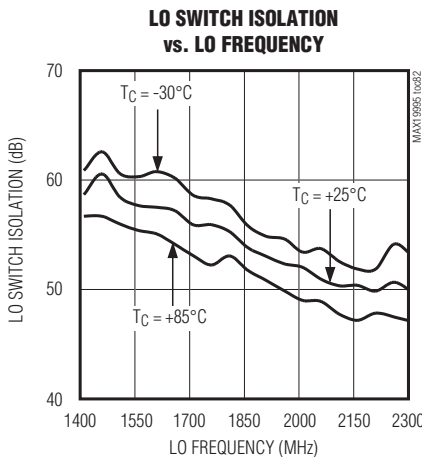
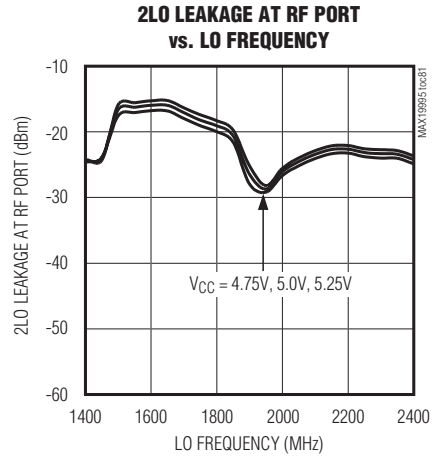
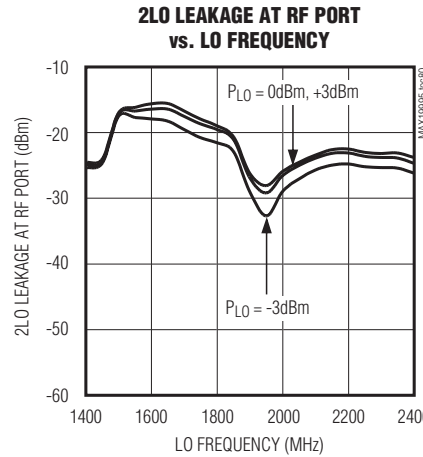
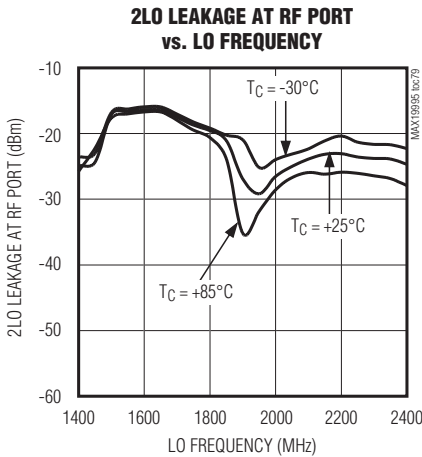
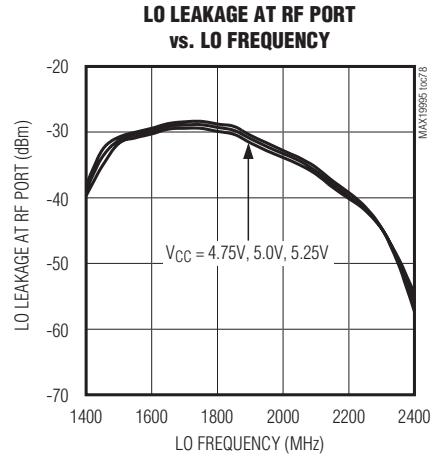
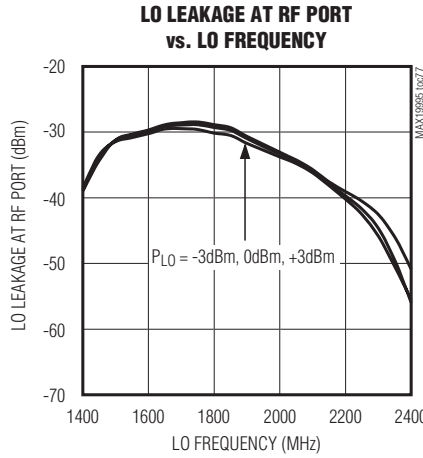
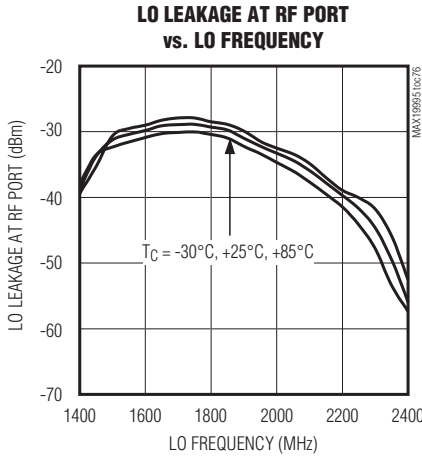

Dual, SiGe, High-Linearity, 1700MHz to 2200MHz Downconversion Mixer with LO Buffer/Switch

Typical Operating Characteristics (continued)

(Typical Application Circuit, optimized for the UMTS band, $R1 = R4 = 681\Omega$, $R2 = R5 = 1.5k\Omega$, $V_{CC} = +5.0V$, $P_{LO} = 0dBm$, $P_{RF} = -5dBm$, LO is low-side injected for a 190MHz IF, $T_C = +25^\circ C$, unless otherwise noted.)

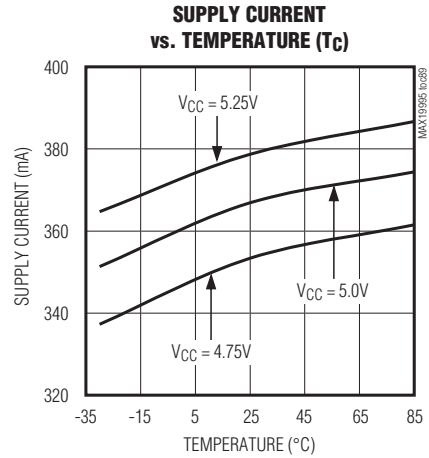
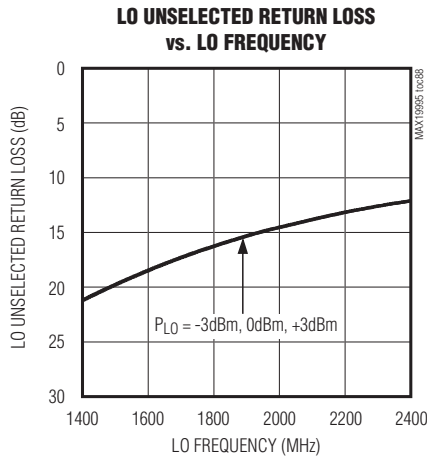
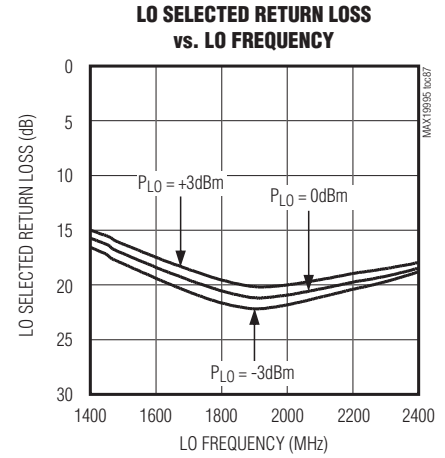
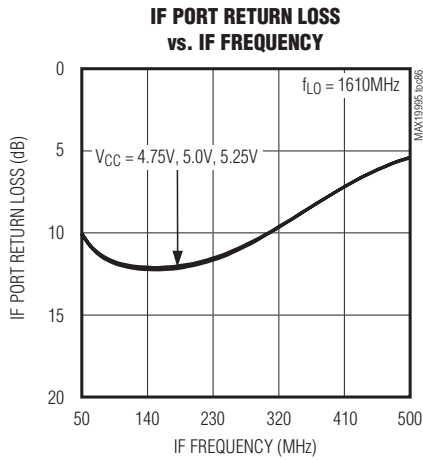
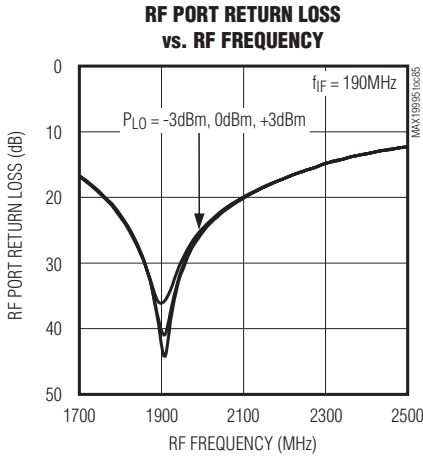

Dual, SiGe, High-Linearity, 1700MHz to 2200MHz Downconversion Mixer with LO Buffer/Switch

Typical Operating Characteristics (continued)

(Typical Application Circuit, $R1 = R4 = 909\Omega$, $R2 = R5 = 2.49k\Omega$, $V_{CC} = +3.3V$, $P_{LO} = 0dBm$, $P_{RF} = -5dBm$, LO is low-side injected for a 190MHz IF, $T_C = +25^\circ C$, unless otherwise noted.)

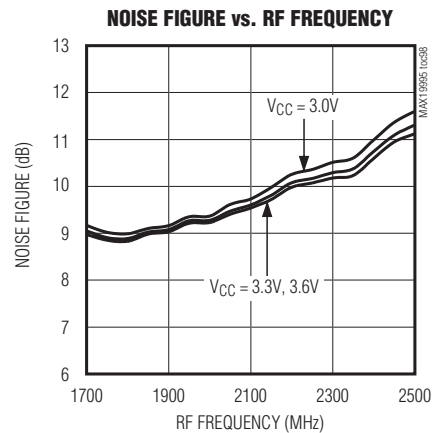
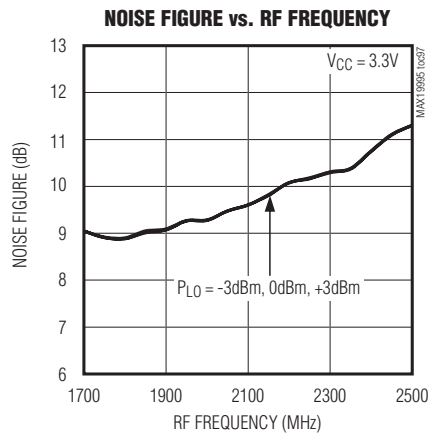
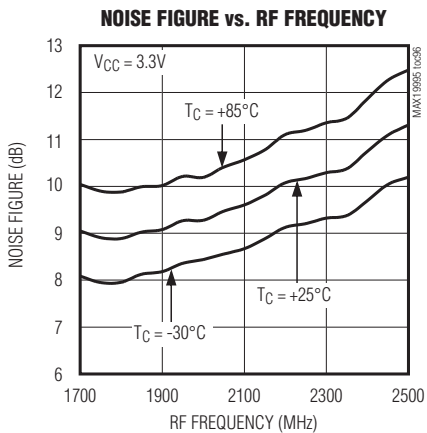
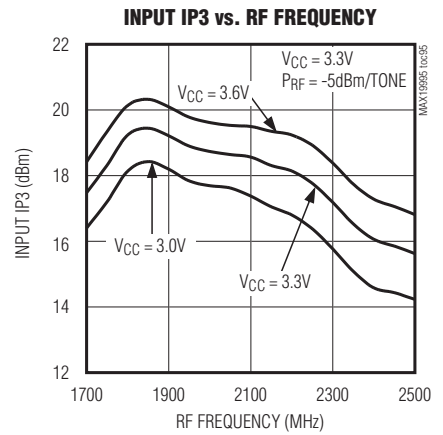
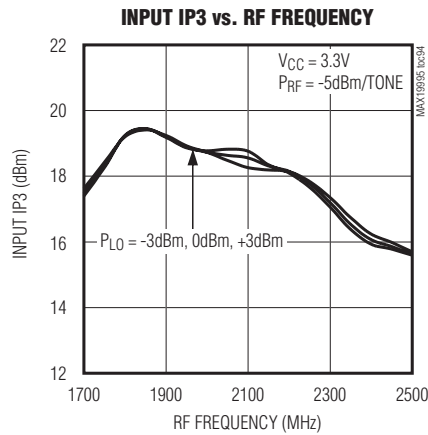
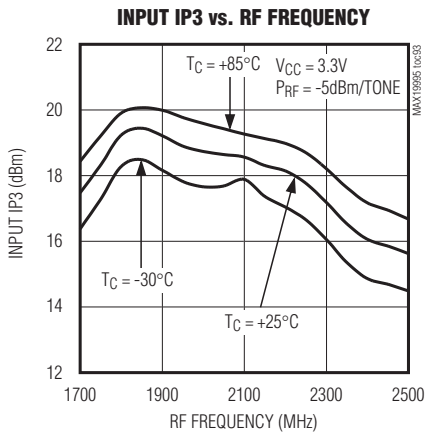
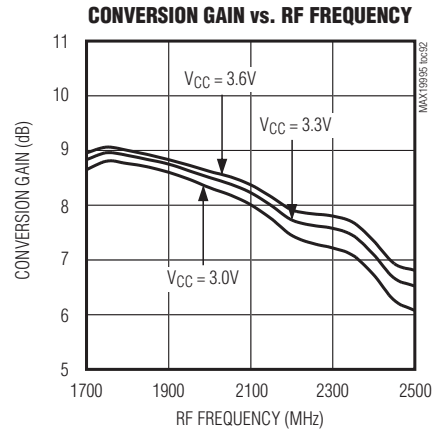
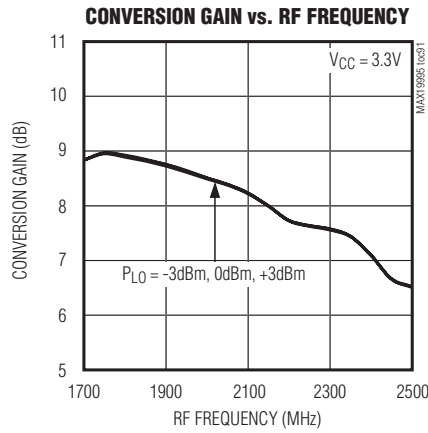
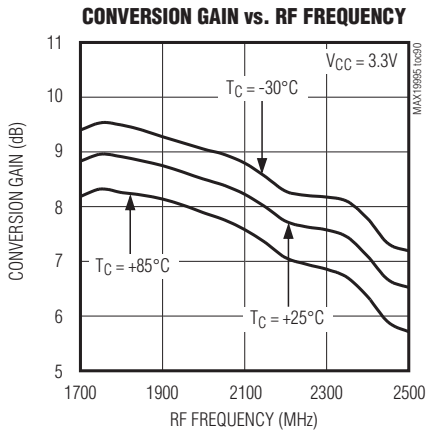

Dual, SiGe, High-Linearity, 1700MHz to 2200MHz Downconversion Mixer with LO Buffer/Switch

Typical Operating Characteristics (continued)

(Typical Application Circuit, $R1 = R4 = 909\Omega$, $R2 = R5 = 2.49k\Omega$, $V_{CC} = +3.3V$, $P_{LO} = 0dBm$, $P_{RF} = -5dBm$, LO is low-side injected for a 190MHz IF, $T_C = +25^\circ C$, unless otherwise noted.)

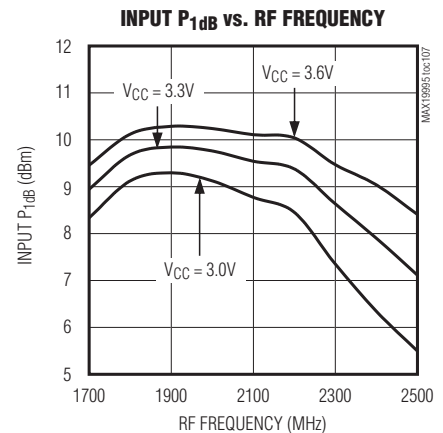
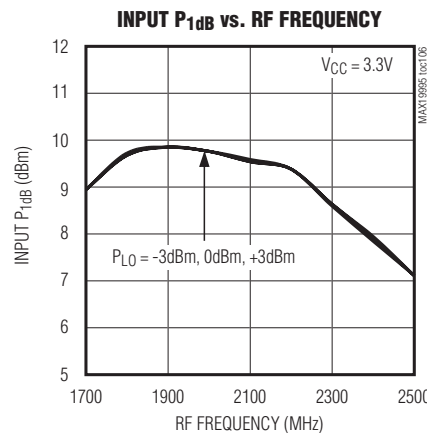
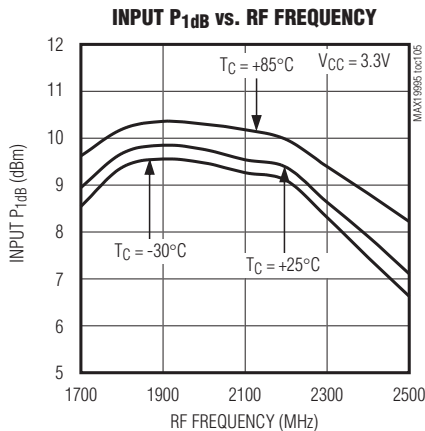
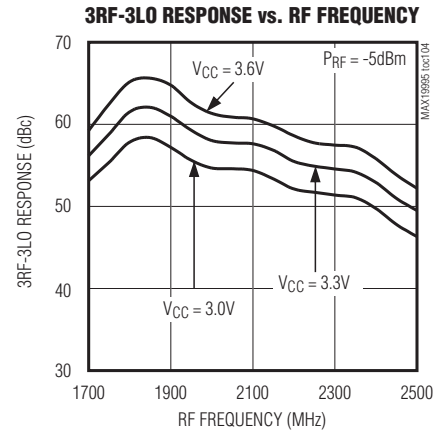
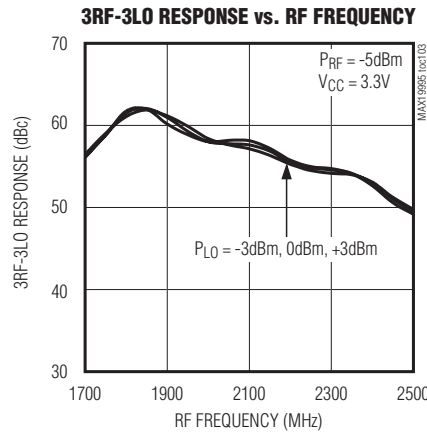
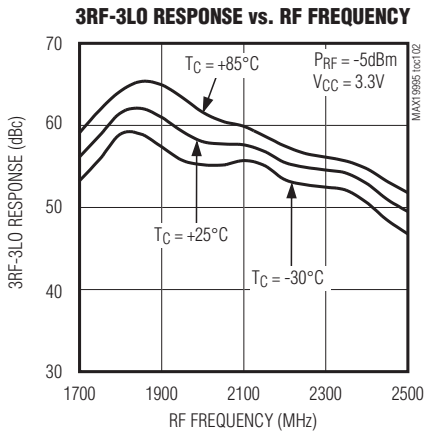
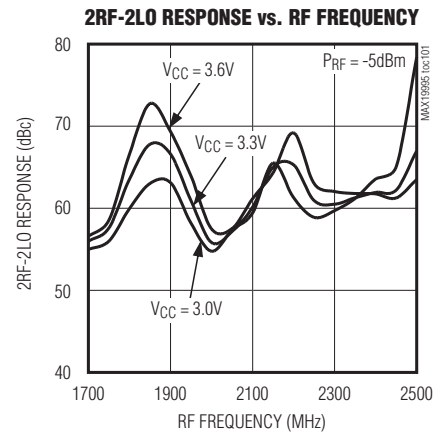
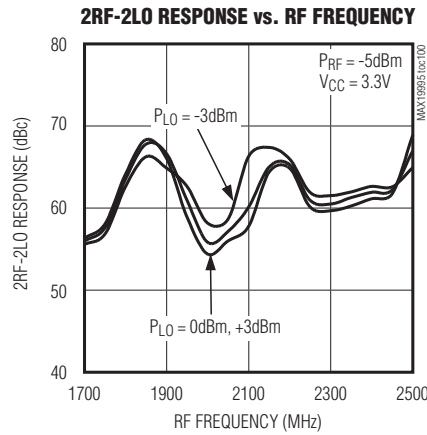
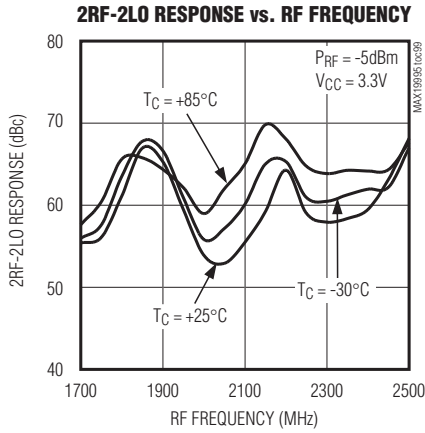

Dual, SiGe, High-Linearity, 1700MHz to 2200MHz Downconversion Mixer with LO Buffer/Switch

Typical Operating Characteristics (continued)

(Typical Application Circuit, $R1 = R4 = 909\Omega$, $R2 = R5 = 2.49k\Omega$, $V_{CC} = +3.3V$, $P_{LO} = 0dBm$, $P_{RF} = -5dBm$, LO is low-side injected for a 190MHz IF, $T_C = +25^\circ C$, unless otherwise noted.)

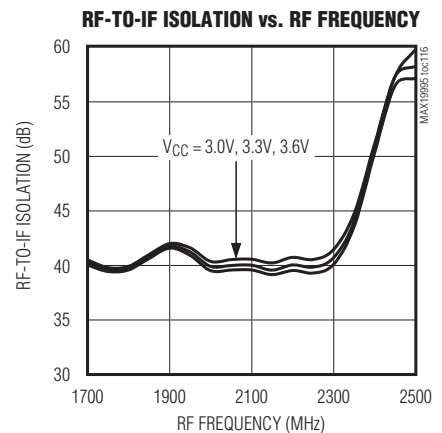
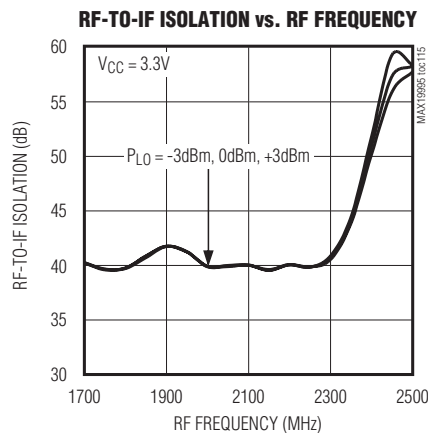
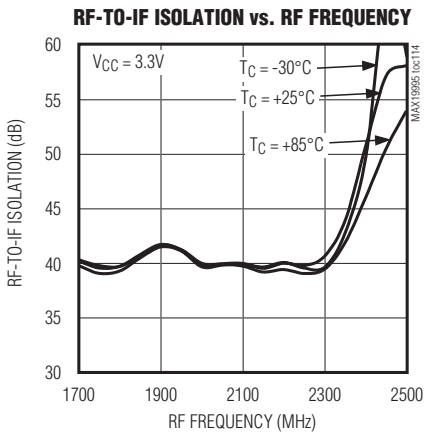
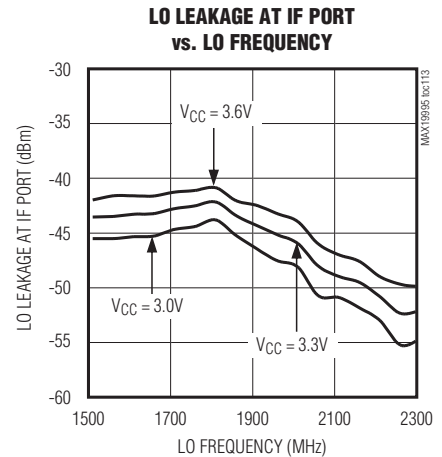
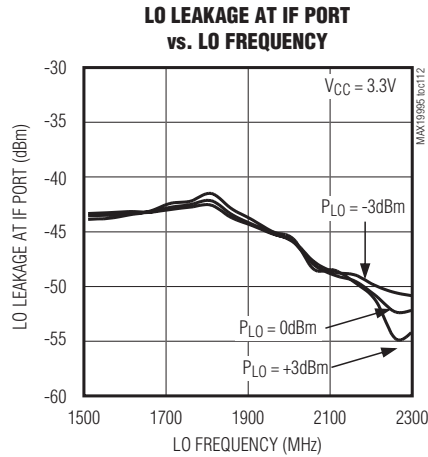
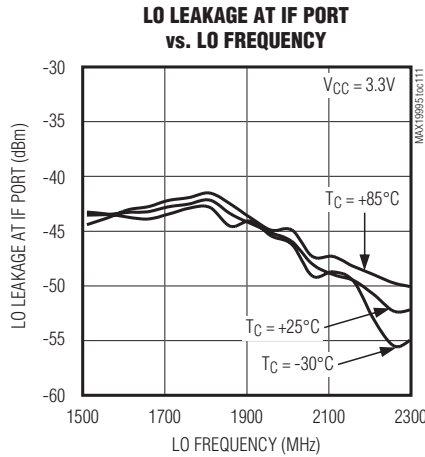
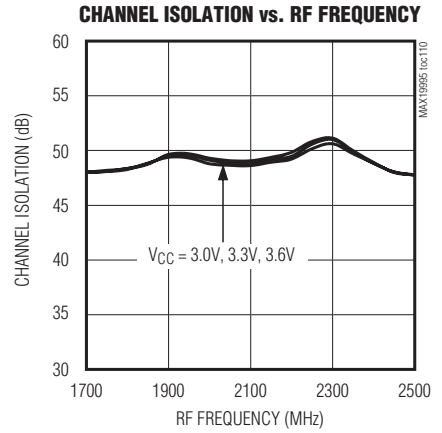
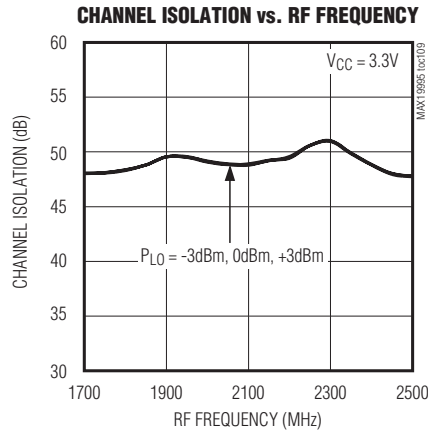
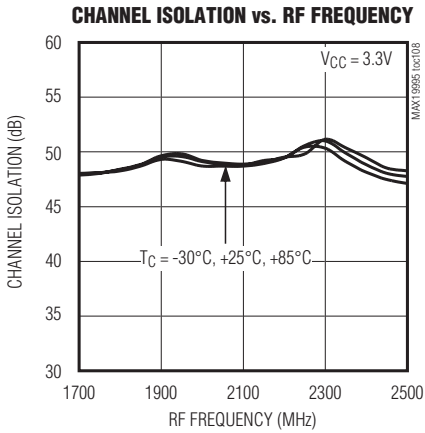

Dual, SiGe, High-Linearity, 1700MHz to 2200MHz Downconversion Mixer with LO Buffer/Switch

Typical Operating Characteristics (continued)

(Typical Application Circuit, $R1 = R4 = 909\Omega$, $R2 = R5 = 2.49k\Omega$, $V_{CC} = +3.3V$, $P_{LO} = 0dBm$, $P_{RF} = -5dBm$, LO is low-side injected for a 190MHz IF, $T_C = +25^\circ C$, unless otherwise noted.)

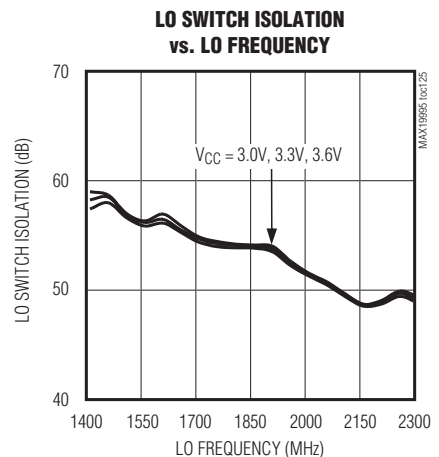
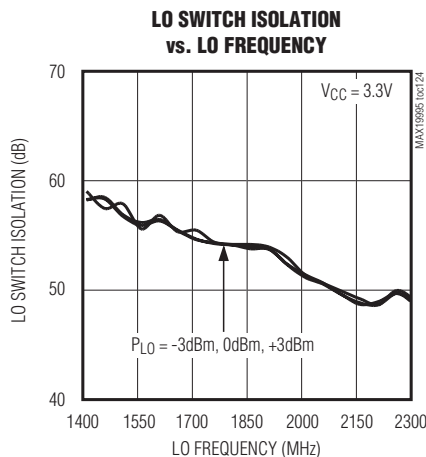
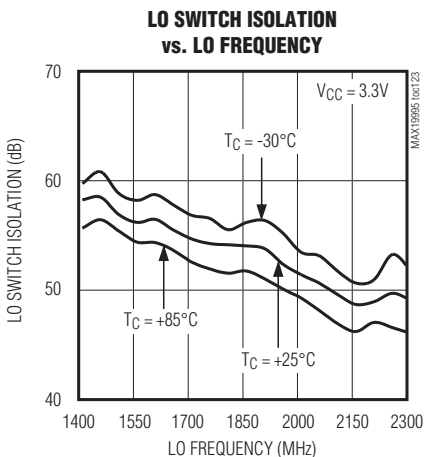
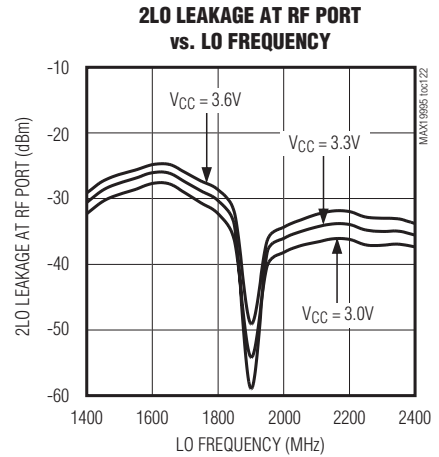
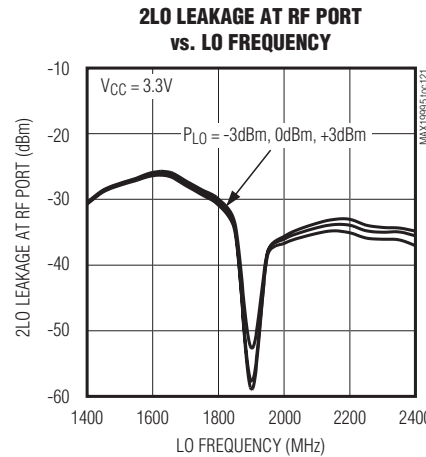
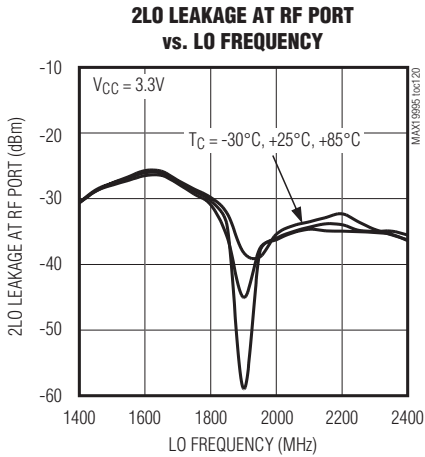
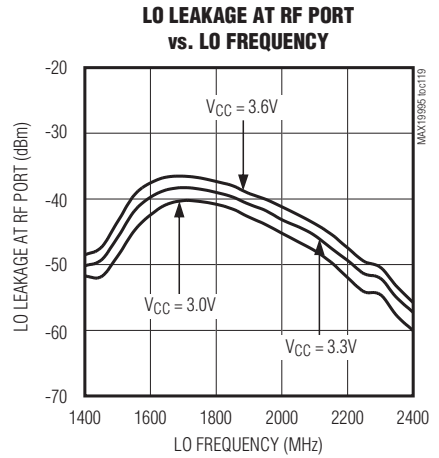
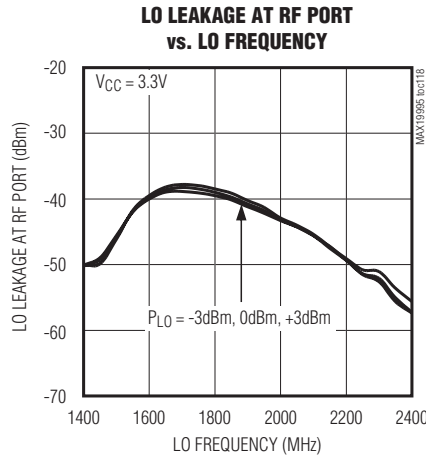
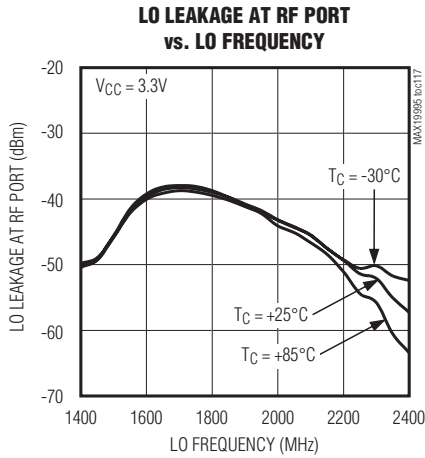

Dual, SiGe, High-Linearity, 1700MHz to 2200MHz Downconversion Mixer with LO Buffer/Switch

Typical Operating Characteristics (continued)

(Typical Application Circuit, $R1 = R4 = 909\Omega$, $R2 = R5 = 2.49k\Omega$, $V_{CC} = +3.3V$, $P_{LO} = 0dBm$, $PRF = -5dBm$, LO is low-side injected for a 190MHz IF, $T_C = +25^\circ C$, unless otherwise noted.)

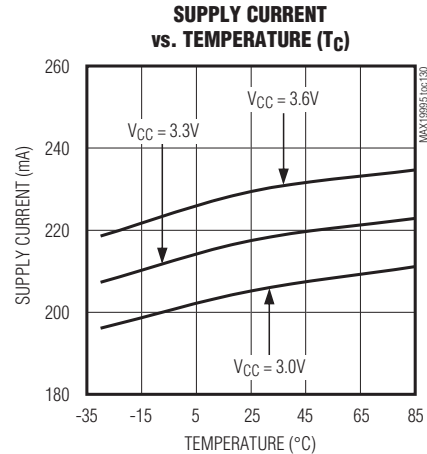
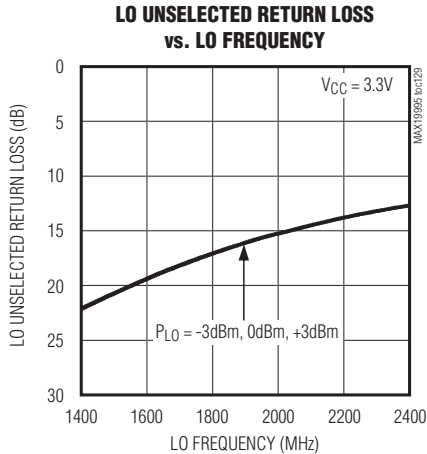
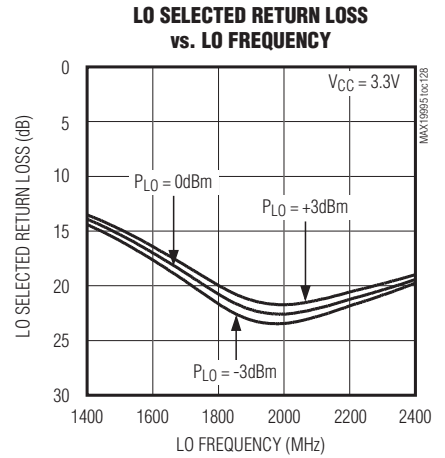
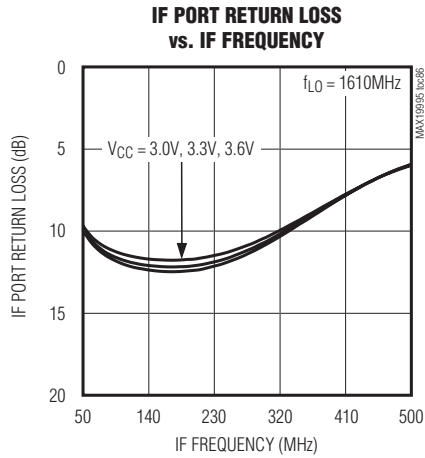
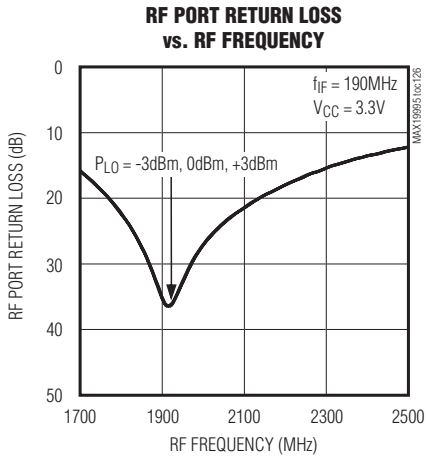

Dual, SiGe, High-Linearity, 1700MHz to 2200MHz Downconversion Mixer with LO Buffer/Switch

Pin Description

PIN	NAME	FUNCTION
1	RFMAIN	Main Channel RF Input. Internally matched to 50Ω. Requires an input DC-blocking capacitor.
2	TAPMAIN	Main Channel Balun Center Tap. Bypass to GND with 39pF and 0.033μF capacitors as close as possible to the pin with the smaller value capacitor closer to the part.
3, 5, 7, 12, 20, 22, 24, 25, 26, 34	GND	Ground
4, 6, 10, 16, 21, 30, 36	VCC	Power Supply. Bypass to GND with capacitors shown in the <i>Typical Application Circuit</i> as close as possible to the pin.
8	TAPDIV	Diversity Channel Balun Center Tap. Bypass to GND with 39pF and 0.033μF capacitors as close as possible to the pin with the smaller value capacitor closer to the part.
9	RFDIV	Diversity Channel RF Input. Internally matched to 50Ω. Requires an input DC-blocking capacitor.
11	IFD_SET	IF Diversity Amplifier Bias Control. Connect a resistor from this pin to ground to set the bias current for the diversity IF amplifier.
13, 14	IFD+, IFD-	Diversity Mixer Differential IF Output. Connect pullup inductors from each of these pins to VCC (see the <i>Typical Application Circuit</i>).
15	IND_EXTD	Diversity External Inductor Connection. Connect this pin to ground. For improved RF-to-IF and LO-to-IF isolation, connect a low-ESR 10nH inductor from this pin to ground (see the <i>Typical Operating Characteristics</i> for typical performance vs. inductor value).
17	LO_ADJ_D	LO Diversity Amplifier Bias Control. Connect a resistor from this pin to ground to set the bias current for the diversity LO amplifier.
18, 28	N.C.	No Connection. Not internally connected.
19	LO1	Local Oscillator 1 Input. This input is internally matched to 50Ω. Requires an input DC-blocking capacitor.
23	LOSEL	Local Oscillator Select. Set this pin to high to select LO1. Set to low to select LO2.
27	LO2	Local Oscillator 2 Input. This input is internally matched to 50Ω. Requires an input DC-blocking capacitor.
29	LO_ADJ_M	LO Main Amplifier Bias Control. Connect a resistor from this pin to ground to set the bias current for the main LO amplifier.
31	IND_EXTM	Main External Inductor Connection. Connect this pin to ground. For improved RF-to-IF and LO-to-IF isolation, connect a low-ESR 10nH inductor from this pin to ground (see the <i>Typical Operating Characteristics</i> for typical performance vs. Inductor value).
32, 33	IFM-, IFM+	Main Mixer Differential IF Output. Connect pullup inductors from each of these pins to VCC (see the <i>Typical Application Circuit</i>).
35	IFM_SET	IF Main Amplifier Bias Control. Connect a resistor from this pin to ground to set the bias current for the main IF amplifier.
—	EP	Exposed Pad. Internally connected to GND. Solder this exposed pad to a PCB pad that uses multiple ground vias to provide heat transfer out of the device into the PCB ground planes. These multiple via grounds are also required to achieve the noted RF performance.

Dual, SiGe, High-Linearity, 1700MHz to 2200MHz Downconversion Mixer with LO Buffer/Switch

Detailed Description

The MAX19995 is a dual-channel downconverter designed to provide 9dB of conversion gain, +24.8dBm input IP3, +13.3dBm 1dB input compression point, and a noise figure of 9dB.

In addition to its high-linearity performance, the MAX19995 achieves a high level of component integration. The device integrates two double-balanced mixers for two-channel downconversion. Both the main and diversity channels include a balun and matching circuitry to allow 50Ω single-ended interfaces to the RF ports and the two LO ports. An integrated single-pole, double-throw (SPDT) switch provides 50ns switching time between the two LO inputs, with 56dB of LO-to-LO isolation and -31dBm of LO leakage at the RF port. Furthermore, the integrated LO buffers provide a high drive level to each mixer core, reducing the LO drive required at the MAX19995's inputs to a range of -3dBm to +3dBm. The IF ports for both channels incorporate differential outputs for downconversion, which is ideal for providing enhanced 2RF-2LO performance.

Specifications are guaranteed over broad frequency ranges to allow for use in WCDMA/LTE, DCS1800/PCS1900 GSM/EDGE, and cdma2000 base stations. The MAX19995 is specified to operate over an RF input range of 1700MHz to 2200MHz, an LO range of 1400MHz to 2000MHz, and an IF range of 50MHz to 500MHz. The external IF components set the lower frequency range. Operation beyond these ranges is possible; see the *Typical Operating Characteristics* for additional information. Although this device is optimized for low-side LO injection applications, it can operate in high-side LO injection modes as well. However, performance degrades as f_{LO} continues to increase. For increased high-side LO performance, refer to the MAX19995A data sheet.

RF Port and Balun

The RF input ports of both the main and diversity channels are internally matched to 50Ω, requiring no external matching components. A DC-blocking capacitor is

required as the input is internally DC shorted to ground through the on-chip balun. The RF port input return loss is typically better than 16dB over the RF frequency range of 1700MHz to 2200MHz.

LO Inputs, Buffer, and Balun

The MAX19995 is optimized for a 1400MHz to 2000MHz LO frequency range. As an added feature, the MAX19995 includes an internal LO SPDT switch for use in frequency-hopping applications. The switch selects one of the two single-ended LO ports, allowing the external oscillator to settle on a particular frequency before it is switched in. LO switching time is typically 50ns, which is more than adequate for typical GSM applications. If frequency hopping is not employed, simply set the switch to either of the LO inputs. The switch is controlled by a digital input (LOSEL), where logic-high selects LO1 and logic-low selects LO2. LO1 and LO2 inputs are internally matched to 50Ω, requiring only 39pF DC-blocking capacitors.

If LOSEL is connected directly to a logic source, then voltage **MUST** be applied to V_{CC} before digital logic is applied to LOSEL to avoid damaging the part. Alternatively, a 1kΩ resistor can be placed in series at the LOSEL to limit the input current in applications where LOSEL is applied before V_{CC} .

The main and diversity channels incorporate a two-stage LO buffer that allows for a wide-input power range for the LO drive. The on-chip low-loss baluns, along with LO buffers, drive the double-balanced mixers. All interfacing and matching components from the LO inputs to the IF outputs are integrated on chip.

High-Linearity Mixer

The core of the MAX19995 dual-channel downconverter consists of two double-balanced, high-performance passive mixers. Exceptional linearity is provided by the large LO swing from the on-chip LO buffers. When combined with the integrated IF amplifiers, the cascaded IIP3, 2RF-2LO rejection, and noise figure performance are typically +24.8dBm, 79dBc, and 9dB, respectively.

Dual, SiGe, High-Linearity, 1700MHz to 2200MHz Downconversion Mixer with LO Buffer/Switch

Differential IF

The MAX19995 has an IF frequency range of 50MHz to 500MHz, where the low-end/high-end frequency depends on the frequency response of the external IF components. Note that these differential ports are ideal for providing enhanced IIP2 performance. Single-ended IF applications require a 4:1 (impedance ratio) balun to transform the 200 Ω differential IF impedance to a 50 Ω single-ended system. After the balun, the return loss is typically 12.5dB. The user can use a differential IF amplifier on the mixer IF ports, but a DC block is required on both IFD+/IFD- and IFM+/IFM- ports to keep external DC from entering the IF ports of the mixer.

Applications Information

Input and Output Matching

The RF and LO inputs are internally matched to 50 Ω . No matching components are required. The RF port input return loss is typically better than 16dB over the RF frequency range of 1700MHz to 2200MHz and return loss at the LO ports are typically better than 16dB over the entire LO range. RF and LO inputs require only DC-blocking capacitors for interfacing.

The IF output impedance is 200 Ω (differential). For evaluation, an external low-loss 4:1 (impedance ratio) balun transforms this impedance to a 50 Ω single-ended output (see the *Typical Application Circuit*).

Reduced-Power Mode

Each channel of the MAX19995 has two pins (LO_ADJ_-, IF_-SET) that allow external resistors to set the internal bias currents. Nominal values for these resistors are given in Table 1. Larger value resistors can be used to reduce power dissipation at the expense of some performance loss. See the *Typical Operating Characteristics* to evaluate the biasing vs. performance tradeoff. If $\pm 1\%$ resistors are not readily available, $\pm 5\%$ resistors may be substituted.

Significant reductions in power consumption can also be realized by operating the mixer with an optional supply voltage of +3.3V. Doing so reduces the overall power consumption by up to 62%. See the *+3.3V Supply AC Electrical Characteristics* and the relevant +3.3V curves in the *Typical Operating Characteristics* section.

IND_EXT_ Inductors

For applications requiring optimum RF-to-IF and LO-to-IF isolation, connect low-ESR inductors from IND_EXT_ (pins 15 and 31) to ground. When improved isolation is not required, connect IND_EXT_ to ground using a 0 Ω resistance. See the *Typical Operating Characteristics* to evaluate the isolation vs. inductor value tradeoff.

Layout Considerations

A properly designed PCB is an essential part of any RF/microwave circuit. Keep RF signal lines as short as possible to reduce losses, radiation, and inductance. The load impedance presented to the mixer must be such that any capacitance from both IF- and IF+ to ground does not exceed several picofarads. For the best performance, route the ground pin traces directly to the exposed pad under the package. The PCB exposed pad **MUST** be connected to the ground plane of the PCB. It is suggested that multiple vias be used to connect this pad to the lower-level ground planes. This method provides a good RF/thermal-conduction path for the device. Solder the exposed pad on the bottom of the device package to the PCB. The MAX19995 evaluation kit can be used as a reference for board layout. Gerber files are available upon request at www.maxim-ic.com.

Power-Supply Bypassing

Proper voltage-supply bypassing is essential for high-frequency circuit stability. Bypass each VCC pin and TAPMAIN/TAPDIV with the capacitors shown in the *Typical Application Circuit* (see Table 1 for component values). Place the TAPMAIN/TAPDIV bypass capacitors to ground within 100 mils of the pin.

Exposed Pad RF/Thermal Considerations

The exposed pad (EP) of the MAX19995's 36-pin thin QFN-EP package provides a low thermal-resistance path to the die. It is important that the PCB on which the MAX19995 is mounted be designed to conduct heat from the EP. In addition, provide the EP with a low-inductance path to electrical ground. The EP **MUST** be soldered to a ground plane on the PCB, either directly or through an array of plated via holes.

Dual, SiGe, High-Linearity, 1700MHz to 2200MHz Downconversion Mixer with LO Buffer/Switch

MAX19995

Table 1. Component Values

COMPONENT	VALUE	DESCRIPTION
C1, C2, C7, C8, C14, C16	39pF	Microwave capacitors (0402)
C3, C6	0.033μF	Microwave capacitors (0603)
C4, C5	—	Not used
C9, C13, C15, C17, C18	0.01μF	Microwave capacitors (0402)
C10, C11, C12, C19, C20, C21	150pF	Microwave capacitors (0603)
L1, L2, L4, L5	330nH	Wire-wound high-Q inductors (0805)
L3, L6	10nH	Wire-wound high-Q inductors (0603). Smaller values can be used at the expense of some performance loss (see the <i>Typical Operating Characteristics</i>).
R1, R4	806Ω	±1% resistors (0402). Used for DCS/PCS band, V_{CC} = +5.0V applications. Larger values can be used to reduce power at the expense of some performance loss.
	681Ω	±1% resistors (0402). Used for UMTS band, V_{CC} = +5.0V applications. Larger values can be used to reduce power at the expense of some performance loss.
	909Ω	±1% resistors (0402). Used for V_{CC} = +3.3V applications.
R2, R5	2.32kΩ	±1% resistors (0402). Used for DCS/PCS band, V_{CC} = +5.0V applications. Larger values can be used to reduce power at the expense of some performance loss.
	1.5kΩ	±1% resistors (0402). Used for UMTS band, V_{CC} = +5.0V applications. Larger values can be used to reduce power at the expense of some performance loss.
	2.49kΩ	±1% resistors (0402). Used for V_{CC} = +3.3V applications.
R3, R6	0Ω	0Ω resistors (1206)
T1, T2	4:1	Transformers (200:50)
U1	—	MAX19995 IC

Dual, SiGe, High-Linearity, 1700MHz to 2200MHz Downconversion Mixer with LO Buffer/Switch

Typical Application Circuit

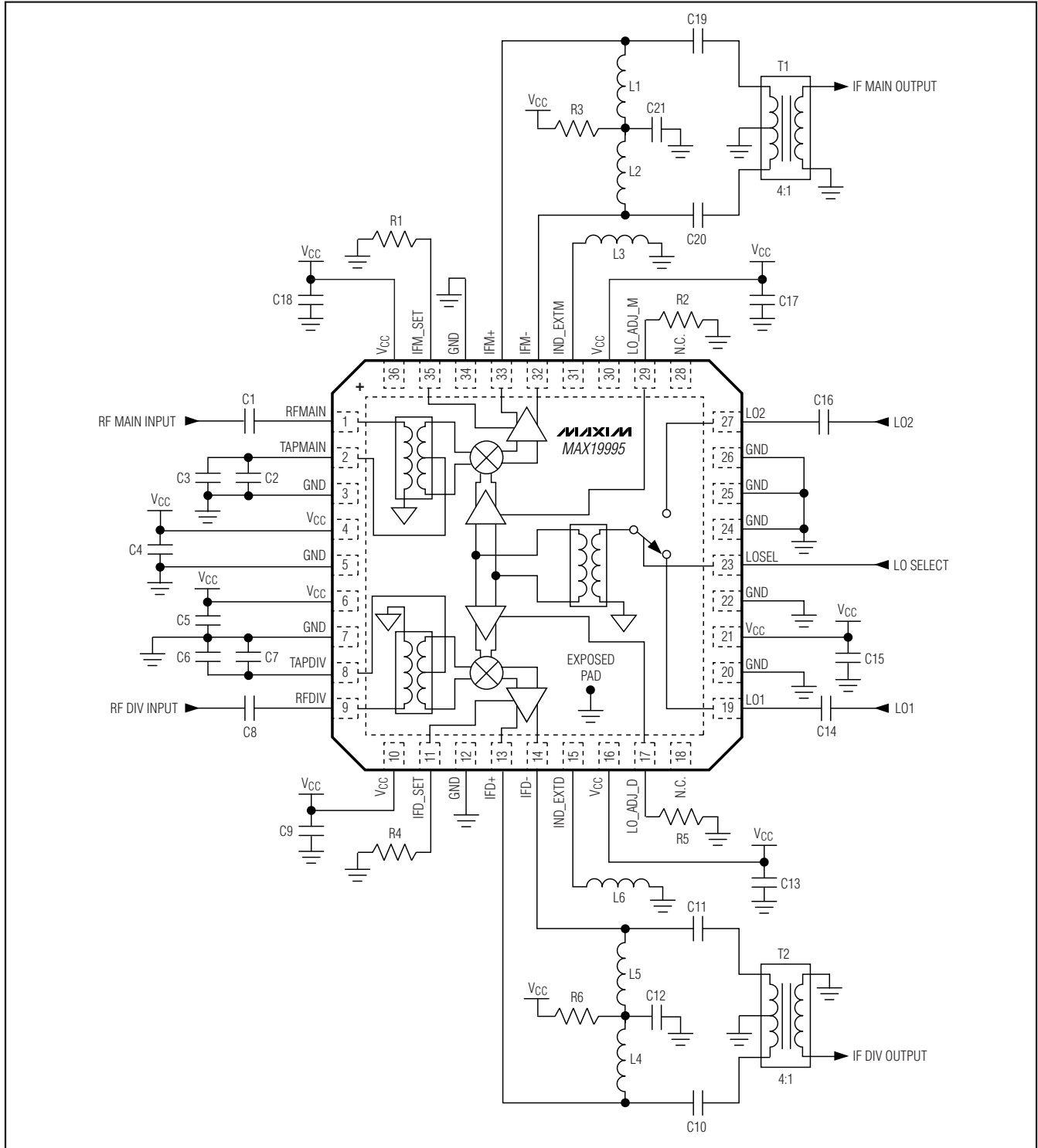

Dual, SiGe, High-Linearity, 1700MHz to 2200MHz Downconversion Mixer with LO Buffer/Switch

Pin Configuration/Functional Diagram

MAX19995

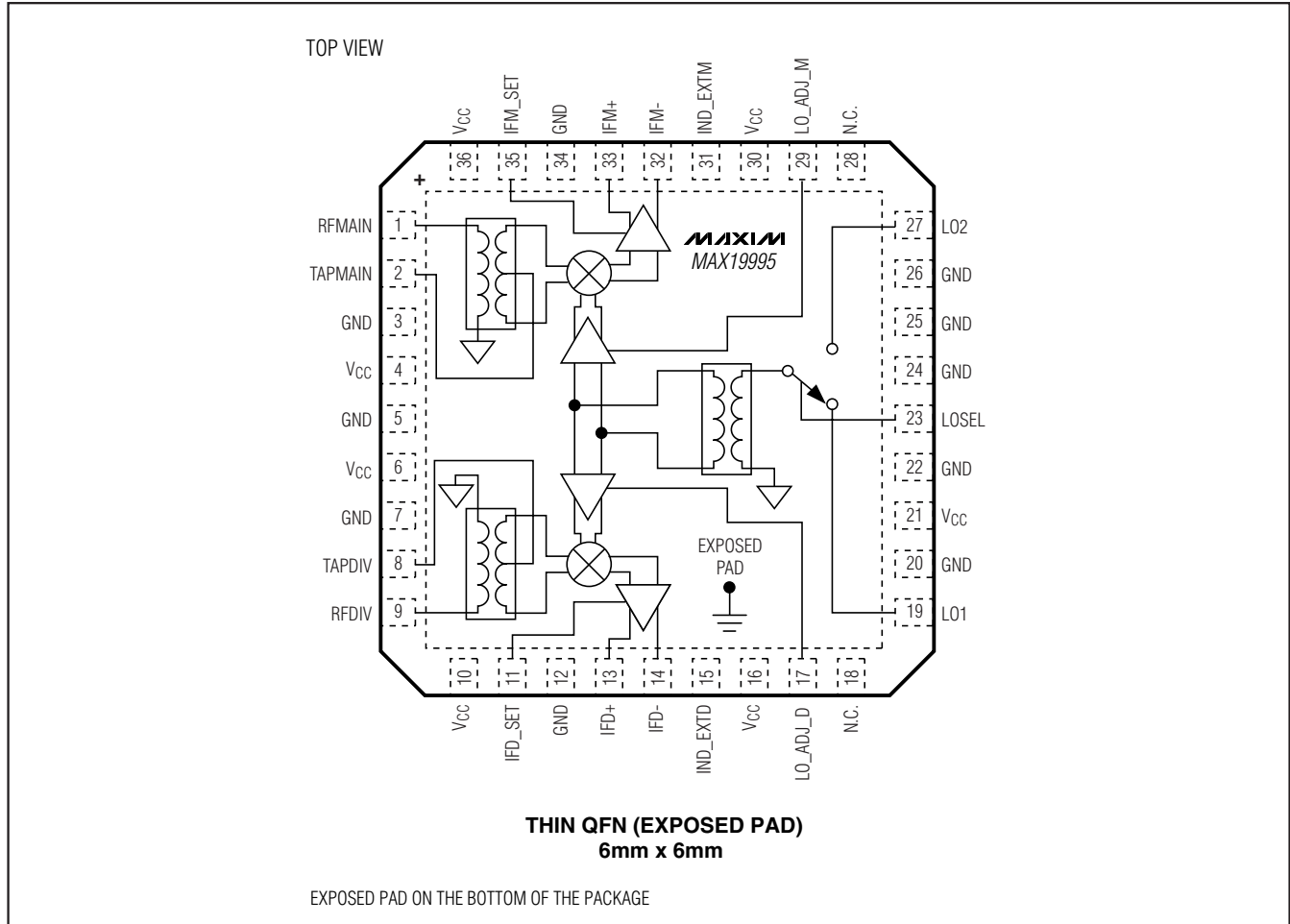

Chip Information

PROCESS: SiGe BiCMOS

Package Information

For the latest package outline information and land patterns, go to www.maxim-ic.com/packages.

PACKAGE TYPE	PACKAGE CODE	DOCUMENT NO.
36 Thin QFN-EP	T3666+2	21-0141

Maxim cannot assume responsibility for use of any circuitry other than circuitry entirely embodied in a Maxim product. No circuit patent licenses are implied. Maxim reserves the right to change the circuitry and specifications without notice at any time.

Maxim Integrated Products, 120 San Gabriel Drive, Sunnyvale, CA 94086 408-737-7600 29