

# 6-Pin DIP High $BV_{CEO}$ Phototransistor Optocouplers

## CNY17 Series, MOC8106M

### Description

The CNY17XM, CNY17FXM, and MOC8106M devices consist of a gallium arsenide infrared emitting diode coupled with an NPN phototransistor in a dual in-line package.

### Features

- High  $BV_{CEO}$ : 70 V Minimum (CNY17XM, CNY17FXM, MOC8106M)
- Closely Matched Current Transfer Ratio (CTR) Minimizes Unit-to-Unit Variation
- Current Transfer Ratio In Select Groups
- Very Low Coupled Capacitance Along With No Chip-to-Pin 6 Base Connection for Minimum Noise Susceptibility (CNY17FXM, MOC8106M)
- Safety and Regulatory Approvals:
  - ◆ UL1577, 4,170 VAC<sub>RMS</sub> for 1 Minute
  - ◆ DIN-EN/IEC60747-5-5, 850 V Peak Working Insulation Voltage

### Applications

- Power Supply Regulators
- Digital Logic Inputs
- Microprocessor Inputs
- Appliance Sensor Systems
- Industrial Controls

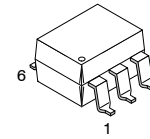

PDIP6  
CASE 646BY

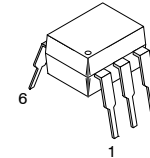

PDIP6  
CASE 646BX

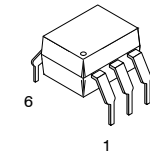

PDIP6  
CASE 646BZ

### MARKING DIAGRAM

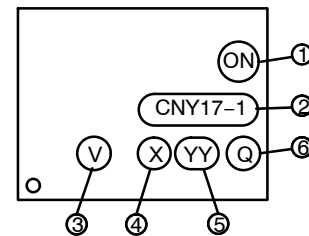

1. ON = onsemi Logo
2. CNY17 = Device Number
3. V = DIN EN/IEC60747-5-5 Option (only appears on component ordered with this option)
4. X = One-Digit Year Code
5. YY = Digit Work Week
6. Q = Assembly Package Code

### ORDERING INFORMATION

See detailed ordering and shipping information on page 8 of this data sheet.

# CNY17 Series, MOC8106M

## SCHEMATICS

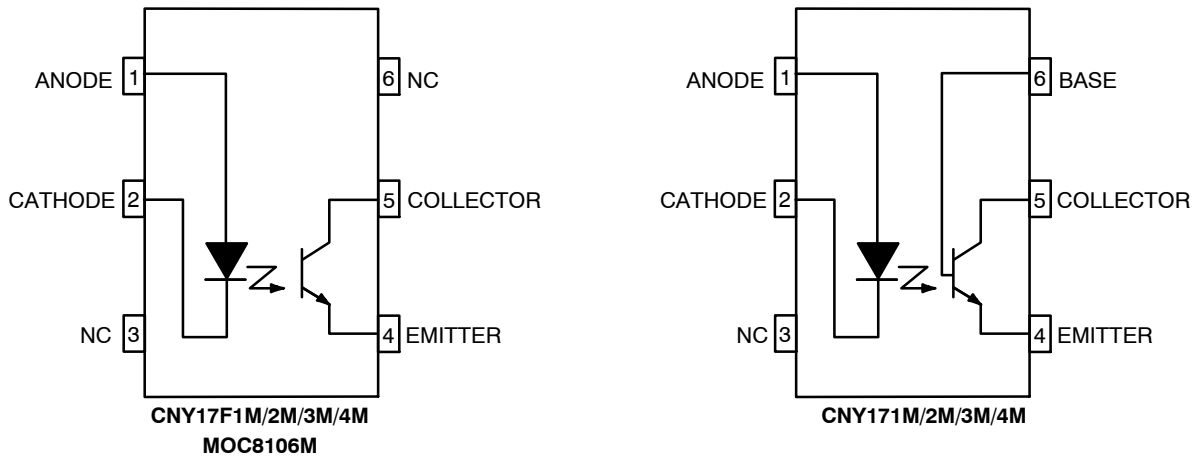

Figure 1. Schematics

## SAFETY AND INSULATION RATINGS

As per DIN EN/IEC 60747-5-5, this optocoupler is suitable for “safe electrical insulation” only within the safety limit data. Compliance with the safety ratings shall be ensured by means of protective circuits.

Parameter		Characteristics
Installation Classifications per DIN VDE 0110/1.89 Table 1, For Rated Mains Voltage	< 150 V <sub>RMS</sub>	I-IV
	< 300 V <sub>RMS</sub>	I-IV
Climatic Classification		55/100/21
Pollution Degree (DIN VDE 0110/1.89)		2
Comparative Tracking Index		175

Symbol	Parameter	Value	Unit
V <sub>PR</sub>	Input-to-Output Test Voltage, Method A, V <sub>IORM</sub> × 1.6 = V <sub>PR</sub> , Type and Sample Test with t <sub>m</sub> = 10 s, Partial Discharge < 5 pC	1360	V <sub>peak</sub>
	Input-to-Output Test Voltage, Method B, V <sub>IORM</sub> × 1.875 = V <sub>PR</sub> , 100% Production Test with t <sub>m</sub> = 1 s, Partial Discharge < 5 pC	1594	V <sub>peak</sub>
V <sub>IORM</sub>	Maximum Working Insulation Voltage	850	V <sub>peak</sub>
V <sub>IOTM</sub>	Highest Allowable Over-Voltage	6000	V <sub>peak</sub>
	External Creepage	≥ 7	mm
	External Clearance	≥ 7	mm
	External Clearance (for Option TV, 0.4" Lead Spacing)	≥ 10	mm
DTI	Distance Through Insulation (Insulation Thickness)	≥ 0.5	mm
T <sub>S</sub>	Case Temperature (Note 1)	175	°C
I <sub>S, INPUT</sub>	Input Current (Note 1)	350	mA
P <sub>S, OUTPUT</sub>	Output Power (Note 1)	800	mW
R <sub>IO</sub>	Insulation Resistance at T <sub>S</sub> , V <sub>IO</sub> = 500 V (Note 1)	> 10 <sup>9</sup>	Ω

1. Safety limit values – maximum values allowed in the event of a failure.

## CNY17 Series, MOC8106M

### ABSOLUTE MAXIMUM RATINGS

Symbol	Parameter	Value	Unit
<b>TOTAL DEVICE</b>			
$T_{STG}$	Storage Temperature	-40 to +125	°C
$T_A$	Ambient Operating Temperature	-40 to +100	°C
$T_J$	Junction Temperature	-40 to +125	°C
$T_{SOL}$	Lead Solder Temperature	260 for 10 seconds	°C
$P_D$	Total Device Power Dissipation @ 25°C (LED plus detector) Derate Linearly From 25°C	270	mW
		2.94	mW/°C
<b>EMITTER</b>			
$I_F$	Continuous Forward Current	60	mA
$V_R$	Reverse Voltage	6	V
$I_F$ (pk)	Forward Current – Peak (1 $\mu$ s pulse, 300 pps)	1.5	A
$P_D$	LED Power Dissipation 25°C Ambient Derate Linearly From 25°C	120	mW
		1.41	mW/°C
<b>DETECTOR</b>			
$I_C$	Continuous Collector Current	50	mA
$V_{CEO}$	Collector–Emitter Voltage	70	V
$V_{ECO}$	Emitter Collector Voltage	7	V
$P_D$	Detector Power Dissipation @ 25°C Derate Linearly from 25°C	150	mW
		1.76	mW/°C

Stresses exceeding those listed in the Maximum Ratings table may damage the device. If any of these limits are exceeded, device functionality should not be assumed, damage may occur and reliability may be affected.

# CNY17 Series, MOC8106M

## ELECTRICAL CHARACTERISTICS

(T<sub>A</sub> = 25°C unless otherwise specified)

### INDIVIDUAL COMPONENT CHARACTERISTICS

Symbol	Parameter	Test Conditions	Device	Min.	Typ.	Max.	Unit
<b>EMITTER</b>							
V <sub>F</sub>	Input Forward Voltage	I <sub>F</sub> = 10 mA	All Devices	1.0	1.15	1.50	V
		I <sub>F</sub> = 60 mA	CNY17XM, CNY17FXM	1.0	1.35	1.65	V
C <sub>J</sub>	Capacitance	V <sub>F</sub> = 0 V, f = 1.0 MHz	All Devices	–	18	–	pF
I <sub>R</sub>	Reverse Leakage Current	V <sub>R</sub> = 6 V	All Devices	–	0.001	10	μA

### DETECTOR

BV <sub>CEO</sub>	Breakdown Voltage Collector-to-Emitter	I <sub>C</sub> = 1 mA, I <sub>F</sub> = 0	All Devices	70	100	–	V
BV <sub>CBO</sub>	Collector-to-Base	I <sub>C</sub> = 10 μA, I <sub>F</sub> = 0	CNY17XM	70	120	–	V
BV <sub>ECO</sub>	Emitter-to-Collector	I <sub>E</sub> = 100 μA, I <sub>F</sub> = 0	All Devices	7	10	–	V
I <sub>CEO</sub>	Leakage Current Collector-to-Emitter	V <sub>CE</sub> = 10 V, I <sub>F</sub> = 0	All Devices	–	1	50	nA
I <sub>CBO</sub>	Collector-to-Base	V <sub>CB</sub> = 10 V, I <sub>F</sub> = 0	CNY17XM	–	–	20	nA
C <sub>CE</sub>	Capacitance Collector-to-Emitter	V <sub>CE</sub> = 0, f = 1 MHz	All Devices	–	8	–	pF
C <sub>CB</sub>	Collector-to-Base	V <sub>CB</sub> = 0, f = 1 MHz	CNY17XM	–	20	–	pF
C <sub>EB</sub>	Emitter-to-Base	V <sub>EB</sub> = 0, f = 1 MHz	CNY17XM	–	10	–	pF

### TRANSFER CHARACTERISTICS

Symbol	Parameter	Test Conditions	Device	Min.	Typ.	Max.	Unit
<b>COUPLED</b>							
CTR	Current Transfer Ratio	I <sub>F</sub> = 10 mA, V <sub>CE</sub> = 10 V	MOC8106M	50	–	150	%
		I <sub>F</sub> = 10 mA, V <sub>CE</sub> = 5 V	CNY171M, CNY17F1M	40	–	80	%
		I <sub>F</sub> = 10 mA, V <sub>CE</sub> = 5 V	CNY172M, CNY17F2M	63	–	125	%
		I <sub>F</sub> = 10 mA, V <sub>CE</sub> = 5 V	CNY173M, CNY17F3M	100	–	200	%
		I <sub>F</sub> = 10 mA, V <sub>CE</sub> = 5 V	CNY174M, CNY17F4M	160	–	320	%
V <sub>CE(SAT)</sub>	Collector-Emitter Saturation Voltage	I <sub>C</sub> = 0.5 mA, I <sub>F</sub> = 5 mA	MOC8106M	–	–	0.4	V
		I <sub>C</sub> = 2.5 mA, I <sub>F</sub> = 10 mA	CNY17XM/CNY17FXM	–	–		

## CNY17 Series, MOC8106M

### AC CHARACTERISTICS

Symbol	Parameter	Test Conditions	Device	Min.	Typ.	Max.	Unit
--------	-----------	-----------------	--------	------	------	------	------

#### NON-SATURATED SWITCHING TIME

$t_{on}$	Turn-On Time	$I_C = 2.0 \text{ mA}$ , $V_{CC} = 10 \text{ V}$ , $R_L = 100 \Omega$	All Devices	-	2.0	10.0	$\mu\text{s}$
$t_{off}$	Turn-Off Time	$I_C = 2.0 \text{ mA}$ , $V_{CC} = 10 \text{ V}$ , $R_L = 100 \Omega$	All Devices	-	3.0	10.0	$\mu\text{s}$
$t_d$	Delay Time	$I_F = 10 \text{ mA}$ , $V_{CC} = 5 \text{ V}$ , $R_L = 75 \Omega$	CNY17XM/CNY17FXM	-	-	5.6	$\mu\text{s}$
$t_r$	Rise Time	$I_F = 10 \text{ mA}$ , $V_{CC} = 5 \text{ V}$ , $R_L = 75 \Omega$	CNY17XM/CNY17FXM	-	-	4.0	$\mu\text{s}$
$t_s$	Storage Time	$I_F = 10 \text{ mA}$ , $V_{CC} = 5 \text{ V}$ , $R_L = 75 \Omega$	CNY17XM/CNY17FXM	-	-	4.1	$\mu\text{s}$
$t_f$	Fall Time	$I_F = 10 \text{ mA}$ , $V_{CC} = 5 \text{ V}$ , $R_L = 75 \Omega$	CNY17XM/CNY17FXM	-	-	3.5	$\mu\text{s}$

#### SATURATED SWITCHING TIME

$t_d$	Delay Time	$I_F = 20 \text{ mA}$ , $V_{CC} = 5 \text{ V}$ , $R_L = 1 \text{ k}\Omega$	CNY171M/F1M	-	-	5.5	$\mu\text{s}$
		$I_F = 10 \text{ mA}$ , $V_{CC} = 5 \text{ V}$ , $R_L = 1 \text{ k}\Omega$	CNY172M/3M/4M CNY17F2M/F3M/F4M	-	-	8.0	$\mu\text{s}$
$t_r$	Rise Time	$I_F = 20 \text{ mA}$ , $V_{CC} = 5 \text{ V}$ , $R_L = 1 \text{ k}\Omega$	CNY171M/F1M	-	-	4.0	$\mu\text{s}$
		$I_F = 10 \text{ mA}$ , $V_{CC} = 5 \text{ V}$ , $R_L = 1 \text{ k}\Omega$	CNY172M/3M/4M CNY17F2M/F3M/F4M	-	-	6.0	$\mu\text{s}$
$t_s$	Storage Time	$I_F = 20 \text{ mA}$ , $V_{CC} = 5 \text{ V}$ , $R_L = 1 \text{ k}\Omega$	CNY171M/F1M	-	-	34.0	$\mu\text{s}$
		$I_F = 10 \text{ mA}$ , $V_{CC} = 5 \text{ V}$ , $R_L = 1 \text{ k}\Omega$	CNY172M/3M/4M CNY17F2M/F3M/F4M	-	-	39.0	$\mu\text{s}$
$t_f$	Fall Time	$I_F = 20 \text{ mA}$ , $V_{CC} = 5 \text{ V}$ , $R_L = 1 \text{ k}\Omega$	CNY171M/F1M	-	-	20.0	$\mu\text{s}$
		$I_F = 10 \text{ mA}$ , $V_{CC} = 5 \text{ V}$ , $R_L = 1 \text{ k}\Omega$	CNY172M/3M/4M CNY17F2M/F3M/F4M	-	-	24.0	$\mu\text{s}$

### ISOLATION CHARACTERISTICS

Symbol	Parameter	Test Conditions	Min.	Typ.	Max.	Unit
VISO	Input-Output Isolation Voltage	$t = 1 \text{ Minute}$	4170	-	-	$V_{AC_{RMS}}$
CISO	Isolation Capacitance	$V_{I-O} = 0 \text{ V}$ , $f = 1 \text{ MHz}$	-	0.2	-	$\text{pF}$
RISO	Isolation Resistance	$V_{I-O} = \pm 500 \text{ VDC}$ , $T_A = 25^\circ\text{C}$	$10^{11}$	-	-	$\Omega$

TYPICAL PERFORMANCE CHARACTERISTICS

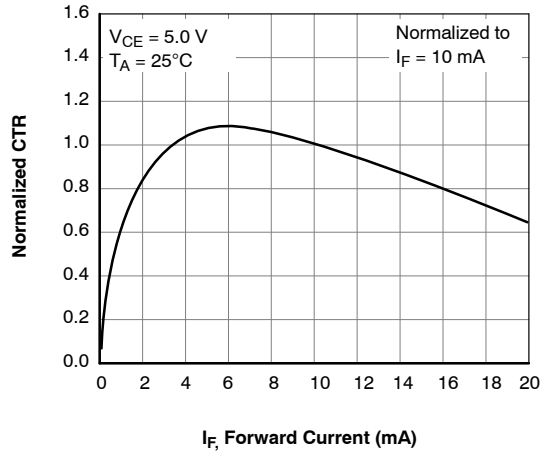

Figure 2. Normalized CTR vs. Forward Current

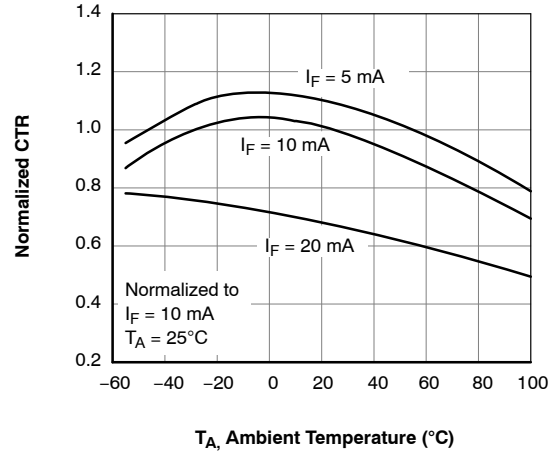

Figure 3. Normalized CTR vs. Ambient Temperature

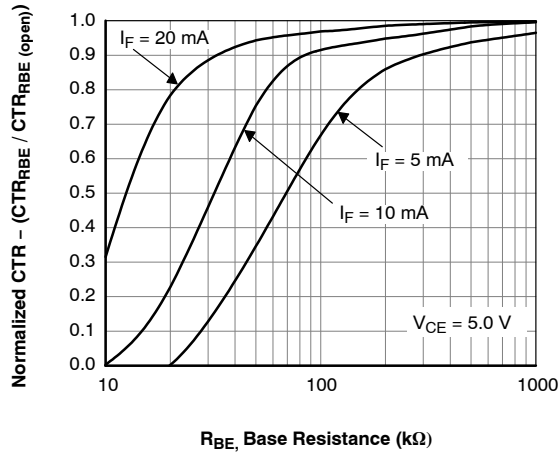

Figure 4. CTR vs. R<sub>BE</sub> (Unsaturated)

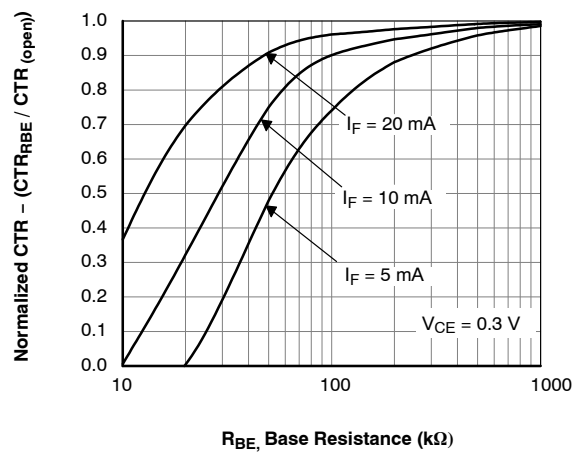

Figure 5. CTR vs. R<sub>BE</sub> (Saturated)

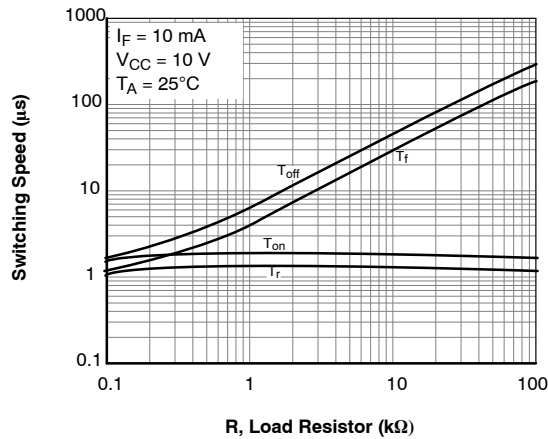

Figure 6. Switching Speed vs. Load Resistor

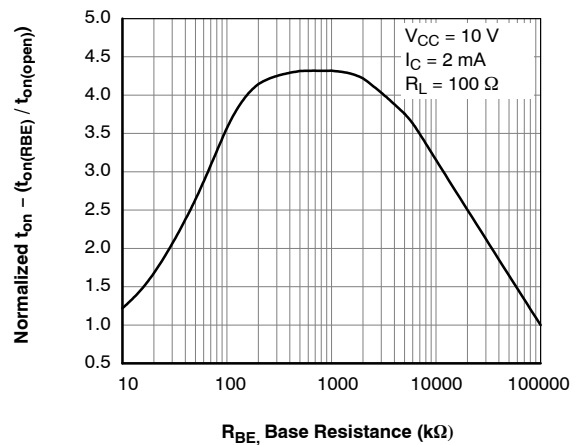

Figure 7. Normalized t<sub>on</sub> vs. R<sub>BE</sub>

TYPICAL PERFORMANCE CHARACTERISTICS (Continued)

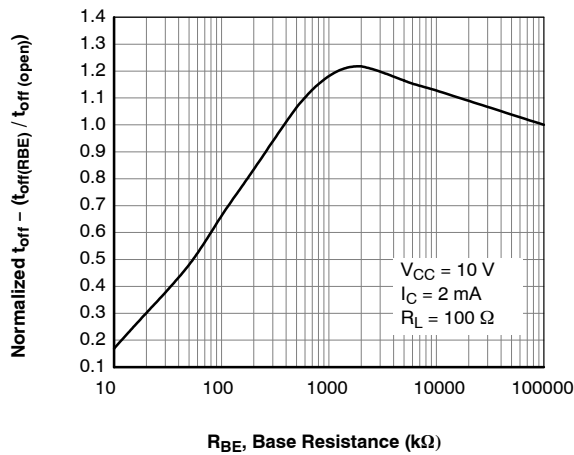

Figure 8. Normalized  $t_{off}$  vs.  $R_{BE}$

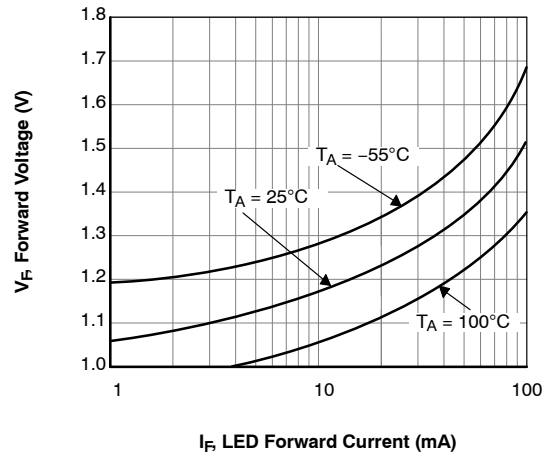

Figure 9. LED Forward Voltage vs. Forward Current

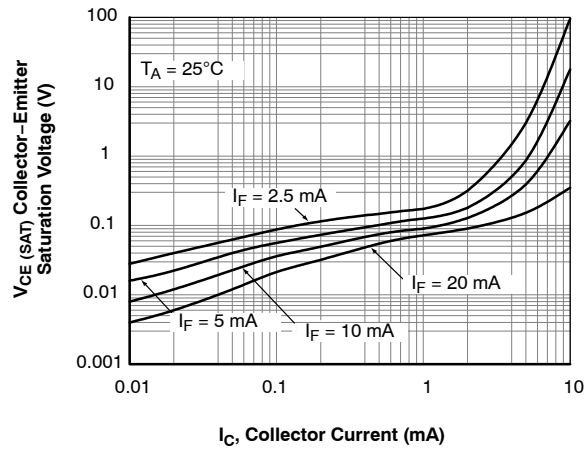

Figure 10. Collector-Emitter Saturation Voltage vs. Collector Current

SWITCHING TEST CIRCUIT AND WAVEFORMS

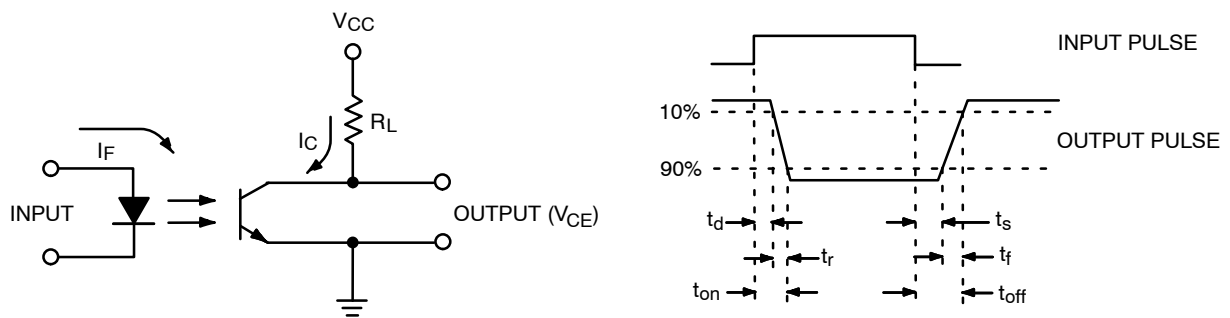

Figure 11. Switching Test Circuit and Waveforms

# CNY17 Series, MOC8106M

## REFLOW PROFILE

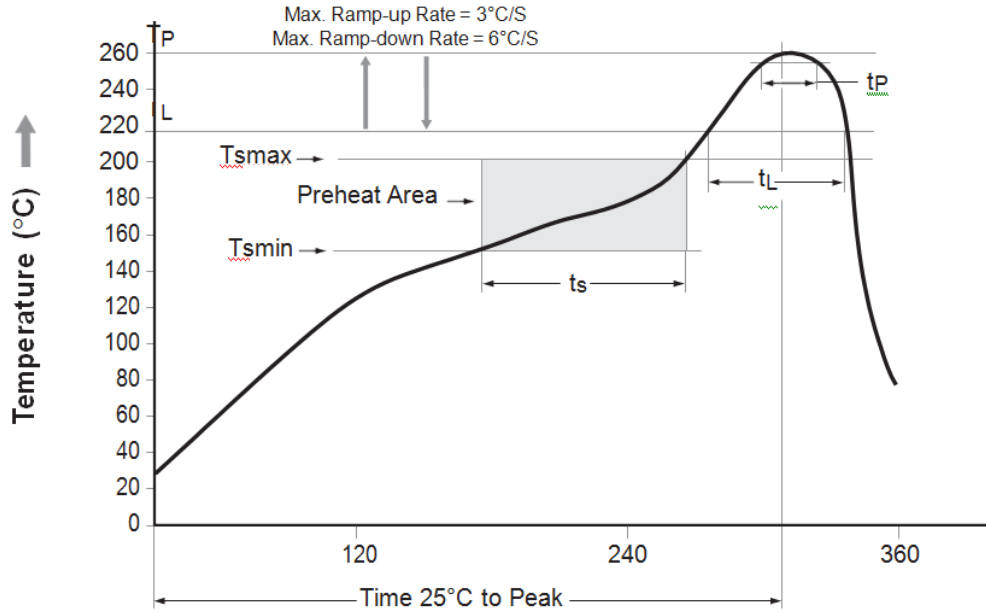

Figure 12. Reflow Profile

Profile Feature	Pb – Free Assembly Profile
Temperature Min. (T <sub>smín</sub> )	150°C
Temperature Max. (T <sub>smáx</sub> )	200°C
Time (t <sub>s</sub> ) from (T <sub>smín</sub> to T <sub>smáx</sub> )	60–120 seconds
Ramp – up Rate (t to t <sub>p</sub> )	3°C/second max.
Liquidous Temperature (T <sub>L</sub> )	217°C
Time (t <sub>L</sub> ) Maintained Above (T <sub>L</sub> )	60–150 seconds
Peak Body Package Temperature	260°C +0°C / –5°C
Time (t <sub>p</sub> ) within 5°C of 260°C	30 seconds
Ramp – down Rate (T <sub>P</sub> to T <sub>L</sub> )	6°C / second max.
Time 25°C to Peak Temperature	8 minutes max.

Table 1. ORDERING INFORMATION

Part Number	Package	Packing Method†
CNY171M	DIP 6–Pin	Tube (50 Units)
CNY171SM	SMT 6–Pin (Lead Bend)	Tube (50 Units)
CNY171SR2M	SMT 6–Pin (Lead Bend)	Tape and Reel (1000 Units)
CNY171TM	DIP 6–Pin, 0.4" Lead Spacing	Tube (50 Units)
CNY171VM	DIP 6–Pin, DIN EN/IEC60747–5–5 Option	Tube (50 Units)
CNY171SVM	SMT 6–Pin (Lead Bend), DIN EN/IEC60747–5–5 Option	Tube (50 Units)
CNY171SR2VM	SMT 6–Pin (Lead Bend), DIN EN/IEC60747–5–5 Option	Tape and Reel (1000 Units)
CNY171TVM	DIP 6–Pin, 0.4" Lead Spacing, DIN EN/IEC60747–5–5 Option	Tube (50 Units)

†For information on tape and reel specifications, including part orientation and tape sizes, please refer to our Tape and Reel Packaging Specification Brochure, BRD8011/D.

2. The product orderable part number system listed in this table also applies to the CNY17FXM product family and the MOC8106M device.



# MECHANICAL CASE OUTLINE

## PACKAGE DIMENSIONS

ON Semiconductor®



PDIP6 8.51x6.35, 2.54P  
CASE 646BX  
ISSUE O

DATE 31 JUL 2016



NOTES:

- A) NO STANDARD APPLIES TO THIS PACKAGE.
- B) ALL DIMENSIONS ARE IN MILLIMETERS.
- C) DIMENSIONS ARE EXCLUSIVE OF BURRS, MOLD FLASH, AND TIE BAR EXTRUSION

<b>DOCUMENT NUMBER:</b>	<b>98AON13449G</b>	Electronic versions are uncontrolled except when accessed directly from the Document Repository. Printed versions are uncontrolled except when stamped "CONTROLLED COPY" in red.
<b>DESCRIPTION:</b>	<b>PDIP6 8.51X6.35, 2.54P</b>	<b>PAGE 1 OF 1</b>

ON Semiconductor and are trademarks of Semiconductor Components Industries, LLC dba ON Semiconductor or its subsidiaries in the United States and/or other countries. ON Semiconductor reserves the right to make changes without further notice to any products herein. ON Semiconductor makes no warranty, representation or guarantee regarding the suitability of its products for any particular purpose, nor does ON Semiconductor assume any liability arising out of the application or use of any product or circuit, and specifically disclaims any and all liability, including without limitation special, consequential or incidental damages. ON Semiconductor does not convey any license under its patent rights nor the rights of others.

# MECHANICAL CASE OUTLINE

## PACKAGE DIMENSIONS

ON Semiconductor®



### PDIP6 8.51x6.35, 2.54P

#### CASE 646BY

#### ISSUE A

DATE 15 JUL 2019



**NOTES:**

1. DIMENSIONING AND TOLERANCING PER ASME Y14.5M, 2009.
2. CONTROLLING DIMENSION: MILLIMETERS
3. DIMENSIONS A, A1, AND L ARE MEASURED WITH THE PACKAGE SEATED.
4. DIMENSIONS D, D1, AND E1 DO NOT INCLUDE MOLD FLASH OR PROTRUSIONS. MOLD FLASH OR PROTRUSIONS ARE NOT TO EXCEED 2.54mm.
5. PACKAGE CONTOUR IS OPTIONAL (ROUNDED OR SQUARE CORNERS).
6. CENTER LINE OF CORNER LEADS ARE LOCATED BY LOCATING THE CENTER OF FEATURE b2 AND b3.

DIM	MILLIMETERS		
	MIN.	NOM.	MAX.
A	---	---	4.80
A1	0.38	---	---
A2	3.28	3.40	3.53
A3	2.49 REF		
A4	1.89 REF		
b	0.41	0.46	0.51
b1	0.76	0.92	1.14
b2	0.25	0.28	0.36
b3	1.02	1.40	1.78
b4	1.778 REF		
c	0.20	0.25	0.30
D	8.13	8.51	8.89
D1	0.86 REF		
E	6.10	6.35	6.60
E1	8.43	9.17	9.90
E2	8.13 REF		
e	2.54 BSC		
L	0.16	0.52	0.88

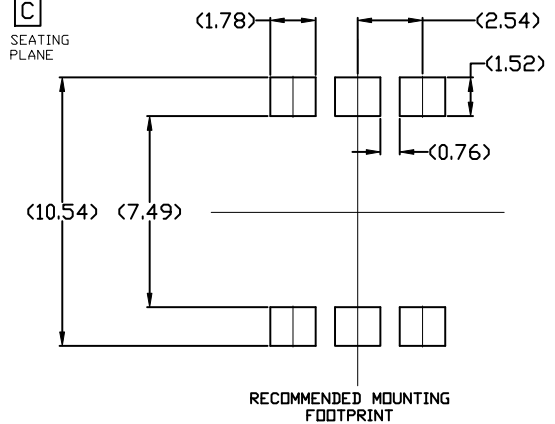

For additional information on our Pb-Free strategy and soldering details, please download the ON Semiconductor Soldering and Mounting Techniques Reference Manual, SOLDERM/D.

<b>DOCUMENT NUMBER:</b>	<b>98AON13450G</b>	Electronic versions are uncontrolled except when accessed directly from the Document Repository. Printed versions are uncontrolled except when stamped "CONTROLLED COPY" in red.
<b>DESCRIPTION:</b>	<b>PDIP6 8.51x6.35, 2.54P</b>	<b>PAGE 1 OF 1</b>

ON Semiconductor and are trademarks of Semiconductor Components Industries, LLC dba ON Semiconductor or its subsidiaries in the United States and/or other countries. ON Semiconductor reserves the right to make changes without further notice to any products herein. ON Semiconductor makes no warranty, representation or guarantee regarding the suitability of its products for any particular purpose, nor does ON Semiconductor assume any liability arising out of the application or use of any product or circuit, and specifically disclaims any and all liability, including without limitation special, consequential or incidental damages. ON Semiconductor does not convey any license under its patent rights nor the rights of others.

**MECHANICAL CASE OUTLINE**  
**PACKAGE DIMENSIONS**

PDIP6 8.51x6.35, 2.54P  
CASE 646BZ  
ISSUE O

DATE 31 JUL 2016



NOTES:

- A) NO STANDARD APPLIES TO THIS PACKAGE.
- B) ALL DIMENSIONS ARE IN MILLIMETERS.
- C) DIMENSIONS ARE EXCLUSIVE OF BURRS, MOLD FLASH, AND TIE BAR EXTRUSION

<b>DOCUMENT NUMBER:</b>	<b>98AON13451G</b>	Electronic versions are uncontrolled except when accessed directly from the Document Repository. Printed versions are uncontrolled except when stamped "CONTROLLED COPY" in red.
<b>DESCRIPTION:</b>	<b>PDIP6 8.51X6.35, 2.54P</b>	<b>PAGE 1 OF 1</b>

ON Semiconductor and **ON** are trademarks of Semiconductor Components Industries, LLC dba ON Semiconductor or its subsidiaries in the United States and/or other countries. ON Semiconductor reserves the right to make changes without further notice to any products herein. ON Semiconductor makes no warranty, representation or guarantee regarding the suitability of its products for any particular purpose, nor does ON Semiconductor assume any liability arising out of the application or use of any product or circuit, and specifically disclaims any and all liability, including without limitation special, consequential or incidental damages. ON Semiconductor does not convey any license under its patent rights nor the rights of others.

**onsemi**, **Onsemi**, and other names, marks, and brands are registered and/or common law trademarks of Semiconductor Components Industries, LLC dba "**onsemi**" or its affiliates and/or subsidiaries in the United States and/or other countries. **onsemi** owns the rights to a number of patents, trademarks, copyrights, trade secrets, and other intellectual property. A listing of **onsemi**'s product/patent coverage may be accessed at [www.onsemi.com/site/pdf/Patent-Marking.pdf](http://www.onsemi.com/site/pdf/Patent-Marking.pdf). **onsemi** reserves the right to make changes at any time to any products or information herein, without notice. The information herein is provided "as-is" and **onsemi** makes no warranty, representation or guarantee regarding the accuracy of the information, product features, availability, functionality, or suitability of its products for any particular purpose, nor does **onsemi** assume any liability arising out of the application or use of any product or circuit, and specifically disclaims any and all liability, including without limitation special, consequential or incidental damages. Buyer is responsible for its products and applications using **onsemi** products, including compliance with all laws, regulations and safety requirements or standards, regardless of any support or applications information provided by **onsemi**. "Typical" parameters which may be provided in **onsemi** data sheets and/or specifications can and do vary in different applications and actual performance may vary over time. All operating parameters, including "Typicals" must be validated for each customer application by customer's technical experts. **onsemi** does not convey any license under any of its intellectual property rights nor the rights of others. **onsemi** products are not designed, intended, or authorized for use as a critical component in life support systems or any FDA Class 3 medical devices or medical devices with a same or similar classification in a foreign jurisdiction or any devices intended for implantation in the human body. Should Buyer purchase or use **onsemi** products for any such unintended or unauthorized application, Buyer shall indemnify and hold **onsemi** and its officers, employees, subsidiaries, affiliates, and distributors harmless against all claims, costs, damages, and expenses, and reasonable attorney fees arising out of, directly or indirectly, any claim of personal injury or death associated with such unintended or unauthorized use, even if such claim alleges that **onsemi** was negligent regarding the design or manufacture of the part. **onsemi** is an Equal Opportunity/Affirmative Action Employer. This literature is subject to all applicable copyright laws and is not for resale in any manner.

## PUBLICATION ORDERING INFORMATION

### LITERATURE FULFILLMENT:

Email Requests to: [orderlit@onsemi.com](mailto:orderlit@onsemi.com)

**onsemi Website:** [www.onsemi.com](http://www.onsemi.com)

### TECHNICAL SUPPORT

**North American Technical Support:**

Voice Mail: 1 800-282-9855 Toll Free USA/Canada

Phone: 011 421 33 790 2910

**Europe, Middle East and Africa Technical Support:**

Phone: 00421 33 790 2910

For additional information, please contact your local Sales Representative