

N-channel 800 V, 3.5  $\Omega$  typ., 2 A MDmesh™ K5 Power MOSFETs  
in DPAK, TO-220FP, TO-220 and IPAK packages

Datasheet – production data

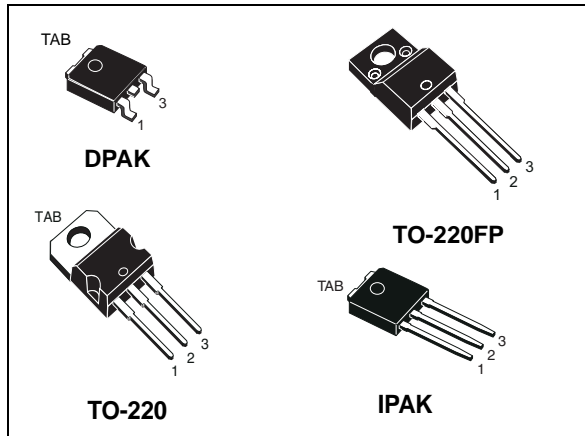
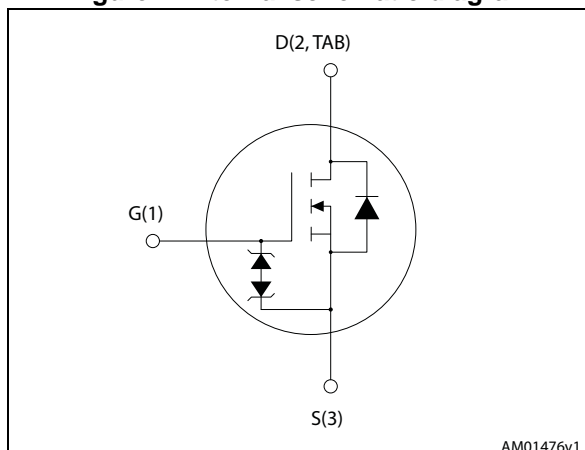

Figure 1. Internal schematic diagram



## Features

Order codes	V <sub>DS</sub>	R <sub>DS(on)</sub> max	I <sub>D</sub>	P <sub>TOT</sub>
STD2N80K5	800 V	4.5 $\Omega$	2 A	45 W
STF2N80K5				20 W
STP2N80K5				45 W
STU2N80K5				

- Industry's lowest R<sub>DS(on)</sub> \* area
- Industry's best figure of merit (FoM)
- Ultra low gate charge
- 100% avalanche tested
- Zener-protected

## Applications

- Switching applications

## Description

These very high voltage N-channel Power MOSFETs are designed using MDmesh™ K5 technology based on an innovative proprietary vertical structure. The result is a dramatic reduction in on-resistance and ultra-low gate charge for applications requiring superior power density and high efficiency.

Table 1. Device summary

Order codes	Marking	Package	Packaging
STD2N80K5	2N80K5	DPAK	Tape and reel
STF2N80K5		TO-220FP	Tube
STP2N80K5		TO-220	
STU2N80K5		IPAK	

# Contents

- 1      Electrical ratings ..... 3**
- 2      Electrical characteristics ..... 4**
  - 2.1    Electrical characteristics (curves) ..... 6
- 3      Test circuits ..... 9**
- 4      Package information ..... 10**
  - 4.1    DPAK (TO-252) type A package information ..... 10
  - 4.2    TO-220FP package information ..... 13
  - 4.3    TO-220 package information ..... 15
  - 4.4    IPAK (TO-251) type A package information ..... 17
- 5      Packaging information ..... 19**
- 6      Revision history ..... 21**

# 1 Electrical ratings

**Table 2. Absolute maximum ratings**

Symbol	Parameter	Value		Unit
		DPAK, TO-220, IPAK	TO-220FP	
$V_{GS}$	Gate- source voltage	30		V
$I_D$	Drain current (continuous) at $T_C = 25\text{ °C}$	2 <sup>(1)</sup>		A
$I_D$	Drain current (continuous) at $T_C = 100\text{ °C}$	1.3		A
$I_{DM}^{(2)}$	Drain current (pulsed)	8		A
$P_{TOT}$	Total dissipation at $T_C = 25\text{ °C}$	45	20	W
$I_{AR}$	Max current during repetitive or single pulse avalanche (pulse width limited by $T_{jmax}$ )	0.5		A
$E_{AS}$	Single pulse avalanche energy (starting $T_J = 25\text{ °C}$ , $I_D=I_{AS}$ , $V_{DD}= 50\text{ V}$ )	60.5		mJ
$dv/dt^{(3)}$	Peak diode recovery voltage slope	4.5		V/ns
$dv/dt^{(4)}$	MOSFET $dv/dt$ ruggedness	50		V/ns
$T_j$	Operating junction temperature	-55 to 150		°C
$T_{stg}$	Storage temperature			°C

1. For TO-220FP limited by maximum junction temperature.
2. Pulse width limited by safe operating area.
3.  $I_{SD} \leq 2\text{ A}$ ,  $di/dt \leq 100\text{ A}/\mu\text{s}$ , peak  $V_{DS} \leq V_{(BR)DSS}$
4.  $V_{DS} \leq 640\text{ V}$

**Table 3. Thermal data**

Symbol	Parameter	Value				Unit
		DPAK	TO-220FP	TO-220	IPAK	
$R_{thj-case}$	Thermal resistance junction-case	2.78	6.25	2.78	2.78	°C/W
$R_{thj-pcb}$	Thermal resistance junction-pcb	50 <sup>(1)</sup>				
$R_{thj-amb}$	Thermal resistance junction-amb		62.5		100	

1. When mounted on FR-4 board of 1 inch<sup>2</sup>, 2 oz Cu.

## 2 Electrical characteristics

( $T_{CASE} = 25\text{ °C}$  unless otherwise specified).

**Table 4. On/off states**

Symbol	Parameter	Test conditions	Min.	Typ.	Max.	Unit
$V_{(BR)DSS}$	Drain-source breakdown voltage ( $V_{GS} = 0$ )	$I_D = 1\text{ mA}$	800			V
$I_{DSS}$	Zero gate voltage drain current ( $V_{GS} = 0$ )	$V_{DS} = 800\text{ V}$			1	$\mu\text{A}$
		$V_{DS} = 800\text{ V } T_C = 125\text{ °C}$			50	$\mu\text{A}$
$I_{GSS}$	Gate body leakage current ( $V_{DS} = 0$ )	$V_{GS} = \pm 20\text{ V}$			$\pm 10$	$\mu\text{A}$
$V_{GS(th)}$	Gate threshold voltage	$V_{DS} = V_{GS}, I_D = 100\text{ }\mu\text{A}$	3	4	5	V
$R_{DS(on)}$	Static drain-source on-resistance	$V_{GS} = 10\text{ V}, I_D = 1\text{ A}$		3.5	4.5	$\Omega$

**Table 5. Dynamic**

Symbol	Parameter	Test conditions	Min.	Typ.	Max.	Unit
$C_{iss}$	Input capacitance	$V_{DS} = 100\text{ V}, f = 1\text{ MHz}, V_{GS} = 0$	-	105	-	pF
$C_{oss}$	Output capacitance		-	8	-	pF
$C_{rss}$	Reverse transfer capacitance		-	0.5	-	pF
$C_{o(tr)}^{(1)}$	Equivalent capacitance time related	$V_{GS} = 0, V_{DS} = 0\text{ to }640\text{ V}$	-	16	-	pF
$C_{o(er)}^{(2)}$	Equivalent capacitance energy related		-	7	-	pF
$R_G$	Intrinsic gate resistance	$f = 1\text{ MHz}, I_D = 0$	-	18	-	$\Omega$
$Q_g$	Total gate charge	$V_{DD} = 640\text{ V}, I_D = 2\text{ A}$ $V_{GS} = 10\text{ V}$	-	5	-	nC
$Q_{gs}$	Gate-source charge		-	1	-	nC
$Q_{gd}$	Gate-drain charge		-	3.7	-	nC

1. Time related is defined as a constant equivalent capacitance giving the same charging time as  $C_{oss}$  when  $V_{DS}$  increases from 0 to 80%  $V_{DSS}$
2. Energy related is defined as a constant equivalent capacitance giving the same stored energy as  $C_{oss}$  when  $V_{DS}$  increases from 0 to 80%  $V_{DSS}$

**Table 6. Switching times**

Symbol	Parameter	Test conditions	Min.	Typ.	Max.	Unit
$t_{d(on)}$	Turn-on delay time	$V_{DD} = 400\text{ V}, I_D = 1\text{ A}, R_G = 4.7\ \Omega, V_{GS} = 10\text{ V}$	-	8	-	ns
$t_r$	Rise time		-	12	-	ns
$t_{d(off)}$	Turn-off delay time		-	19	-	ns
$t_f$	Fall time		-	32	-	ns

**Table 7. Source drain diode**

Symbol	Parameter	Test conditions	Min.	Typ.	Max.	Unit
$I_{SD}$	Source-drain current		-		2	A
$I_{SDM}^{(1)}$	Source-drain current (pulsed)		-		8	A
$V_{SD}^{(2)}$	Forward on voltage	$I_{SD} = 2\text{ A}, V_{GS} = 0$	-		1.5	V
$t_{rr}$	Reverse recovery time	$I_{SD} = 2\text{ A}, V_{DD} = 60\text{ V}$ $di/dt = 100\text{ A}/\mu\text{s}$ ,	-	255		ns
$Q_{rr}$	Reverse recovery charge		-	1		$\mu\text{C}$
$I_{RRM}$	Reverse recovery current		-	8		A
$t_{rr}$	Reverse recovery time	$I_{SD} = 2\text{ A}, V_{DD} = 60\text{ V}$ $di/dt = 100\text{ A}/\mu\text{s}$ , $T_J = 150\text{ }^\circ\text{C}$	-	285		ns
$Q_{rr}$	Reverse recovery charge		-	1.45		$\mu\text{C}$
$I_{RRM}$	Reverse recovery current		-	7.5		A

1. Pulse width limited by safe operating area
2. Pulsed: pulse duration = 300  $\mu\text{s}$ , duty cycle 1.5%

**Table 8. Gate-source Zener diode**

Symbol	Parameter	Test conditions	Min.	Typ.	Max.	Unit
$V_{(BR)GSO}$	Gate-source breakdown voltage	$I_{GS} = \pm 1\text{ mA}, I_D = 0$	30	-	-	V

The built-in back-to-back Zener diodes have been specifically designed to enhance the ESD capability of the device. The Zener voltage is appropriate for efficient and cost-effective intervention to protect the device integrity. These integrated Zener diodes thus eliminate the need for external components.

## 2.1 Electrical characteristics (curves)

Figure 2. Safe operating area for DPAK and IPAK

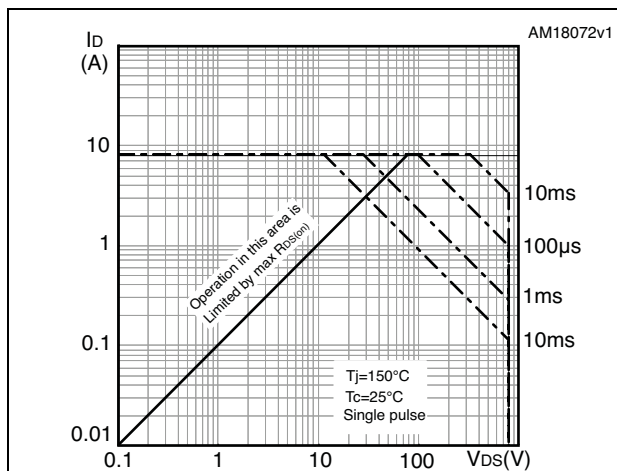

Figure 3. Thermal impedance for DPAK and IPAK

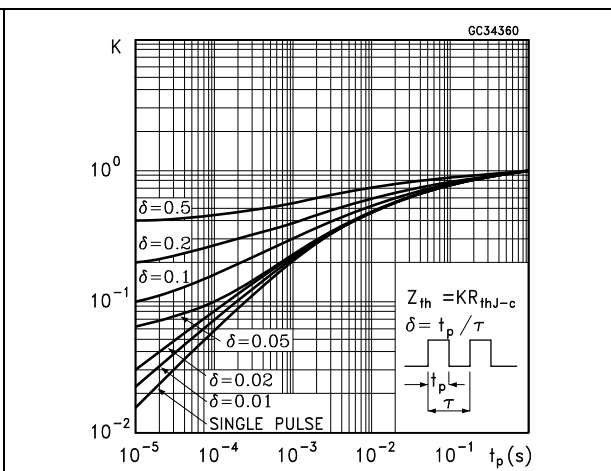

Figure 4. Safe operating area for TO-220FP

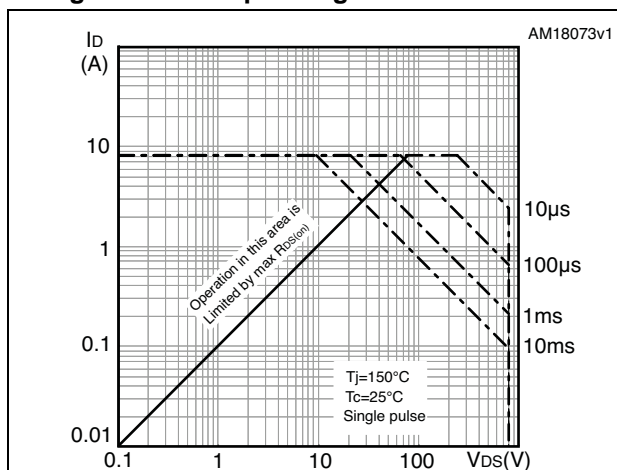

Figure 5. Thermal impedance for TO-220FP

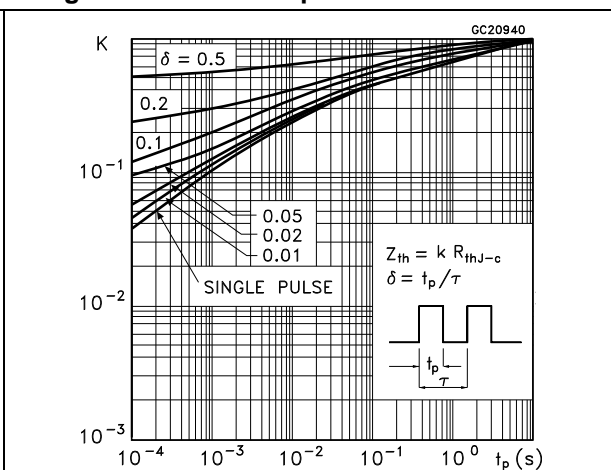

Figure 6. Safe operating area for TO-220

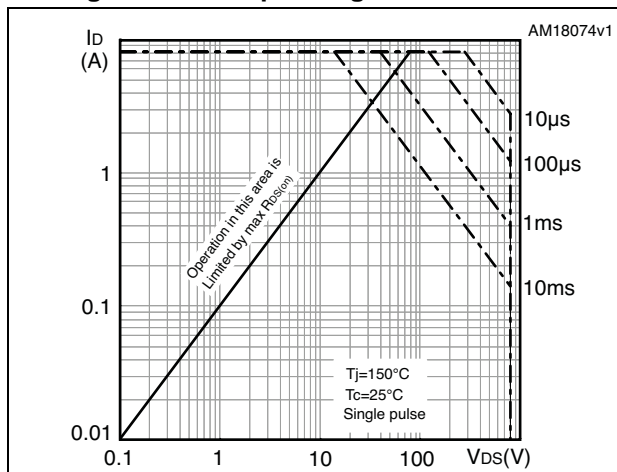

Figure 7. Thermal impedance for TO-220

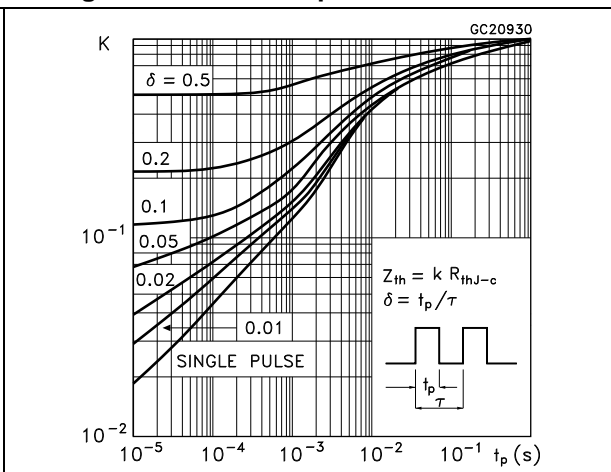

Figure 8. Output characteristics

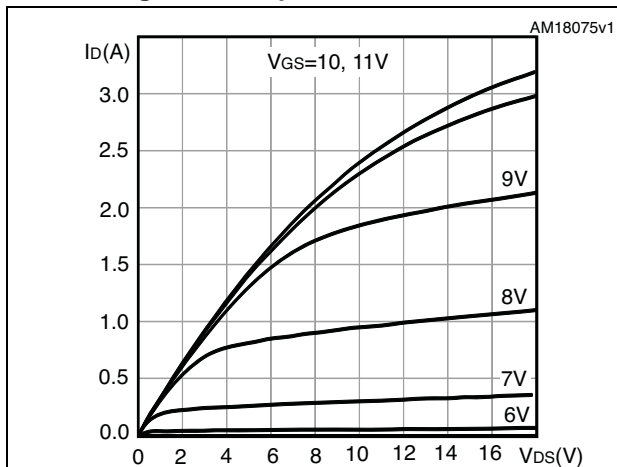

Figure 9. Transfer characteristics

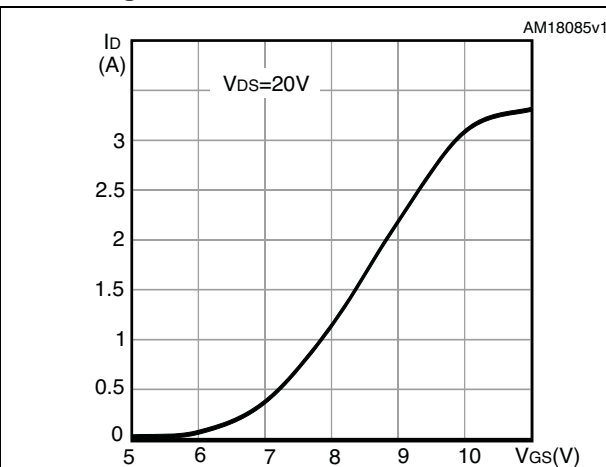

Figure 10. Gate charge vs gate-source voltage

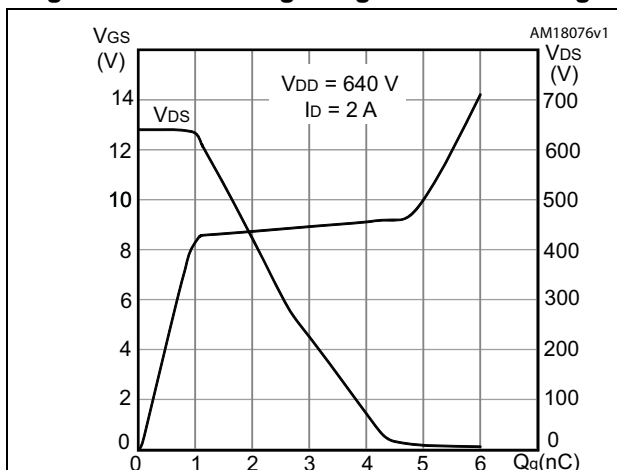

Figure 11. Static drain-source on-resistance

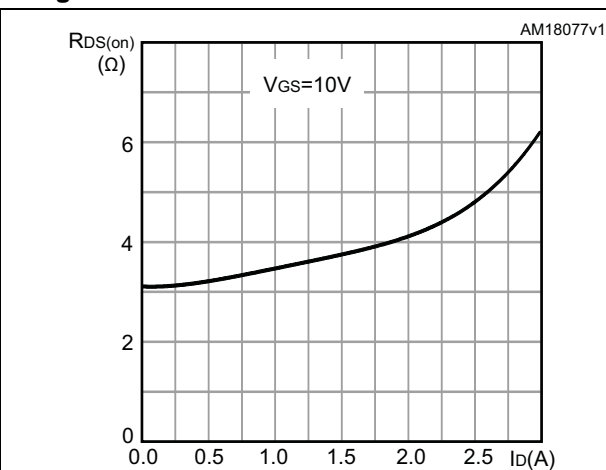

Figure 12. Capacitance variations

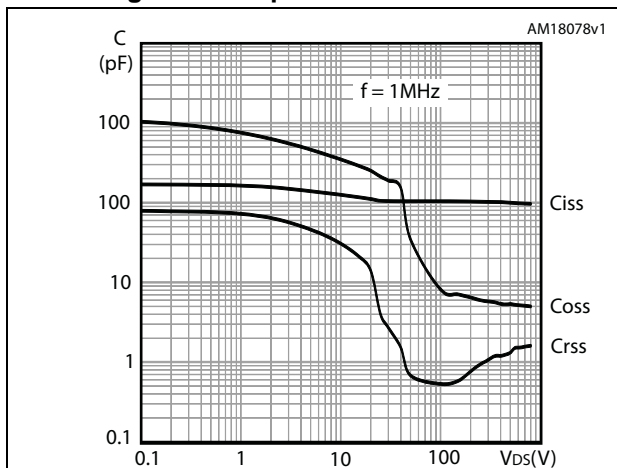

Figure 13. Output capacitance stored energy

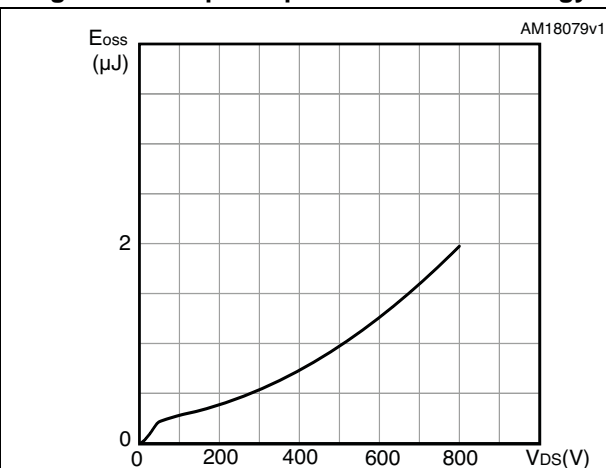

Figure 14. Normalized gate threshold voltage vs temperature

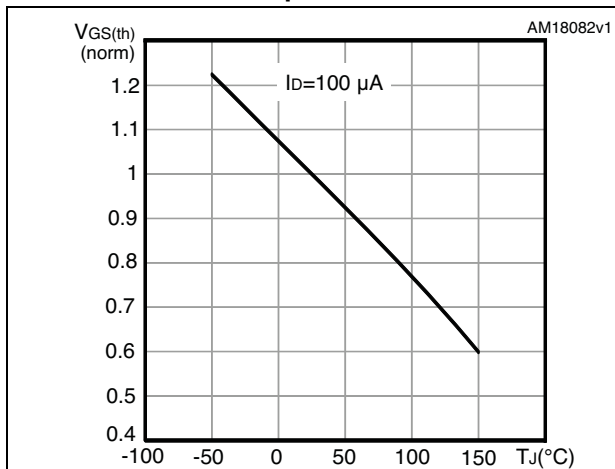

Figure 15. Normalized on-resistance vs temperature

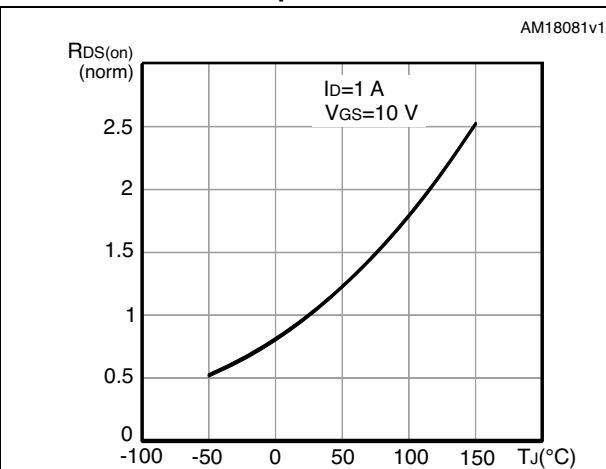

Figure 16. Normalized V<sub>(BR)DSS</sub> vs temperature

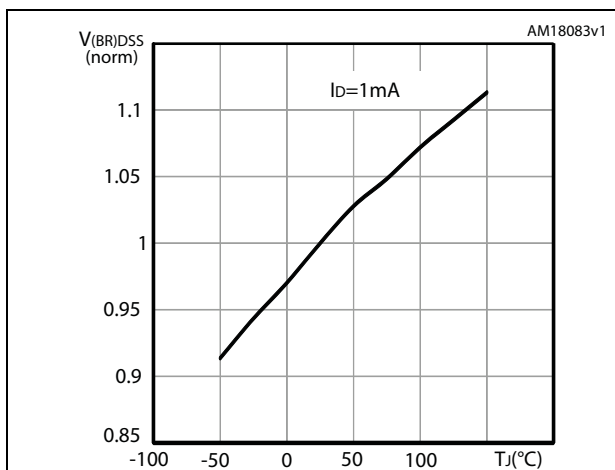

Figure 17. Source-drain diode forward characteristics

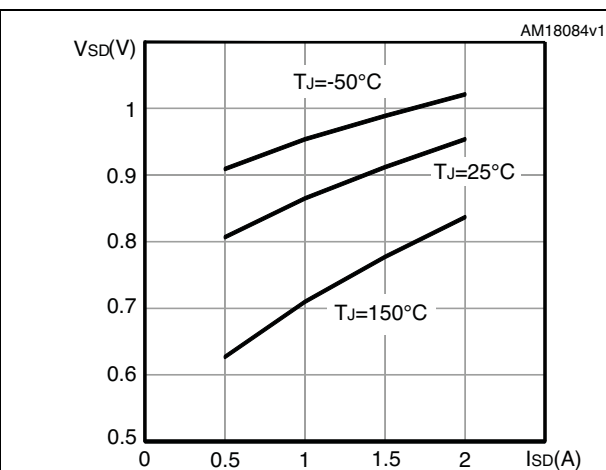
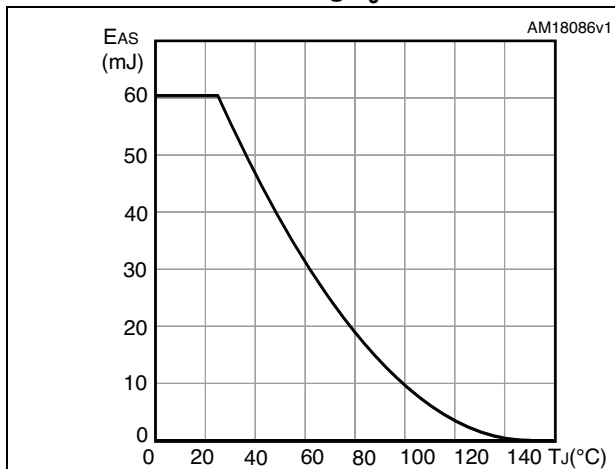

Figure 18. Maximum avalanche energy vs starting T<sub>J</sub>





### 3 Test circuits

Figure 19. Switching times test circuit for resistive load



AM01468v1

Figure 20. Gate charge test circuit



AM01469v1

Figure 21. Test circuit for inductive load switching and diode recovery times



AM01470v1

Figure 22. Unclamped inductive load test circuit



AM01471v1

Figure 23. Unclamped inductive waveform

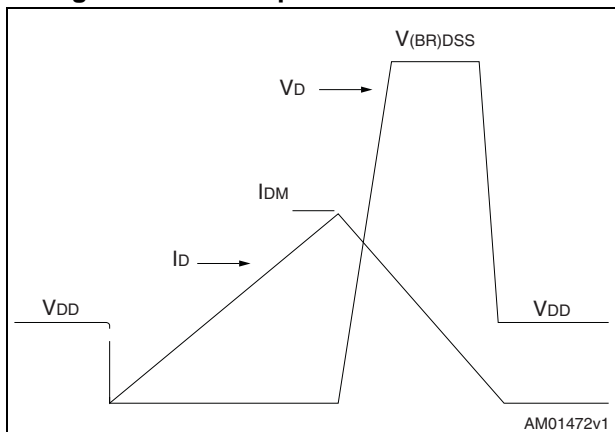

AM01472v1

Figure 24. Switching time waveform

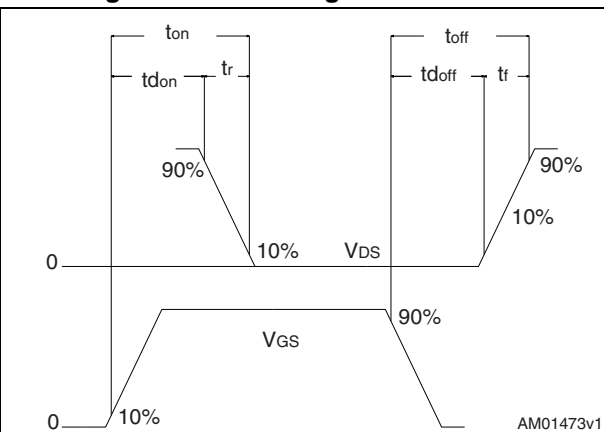

AM01473v1

## 4 Package information

In order to meet environmental requirements, ST offers these devices in different grades of ECOPACK® packages, depending on their level of environmental compliance. ECOPACK® specifications, grade definitions and product status are available at: [www.st.com](http://www.st.com). ECOPACK® is an ST trademark.

### 4.1 DPAK (TO-252) type A package information

Figure 25. DPAK (TO-252) type A outline

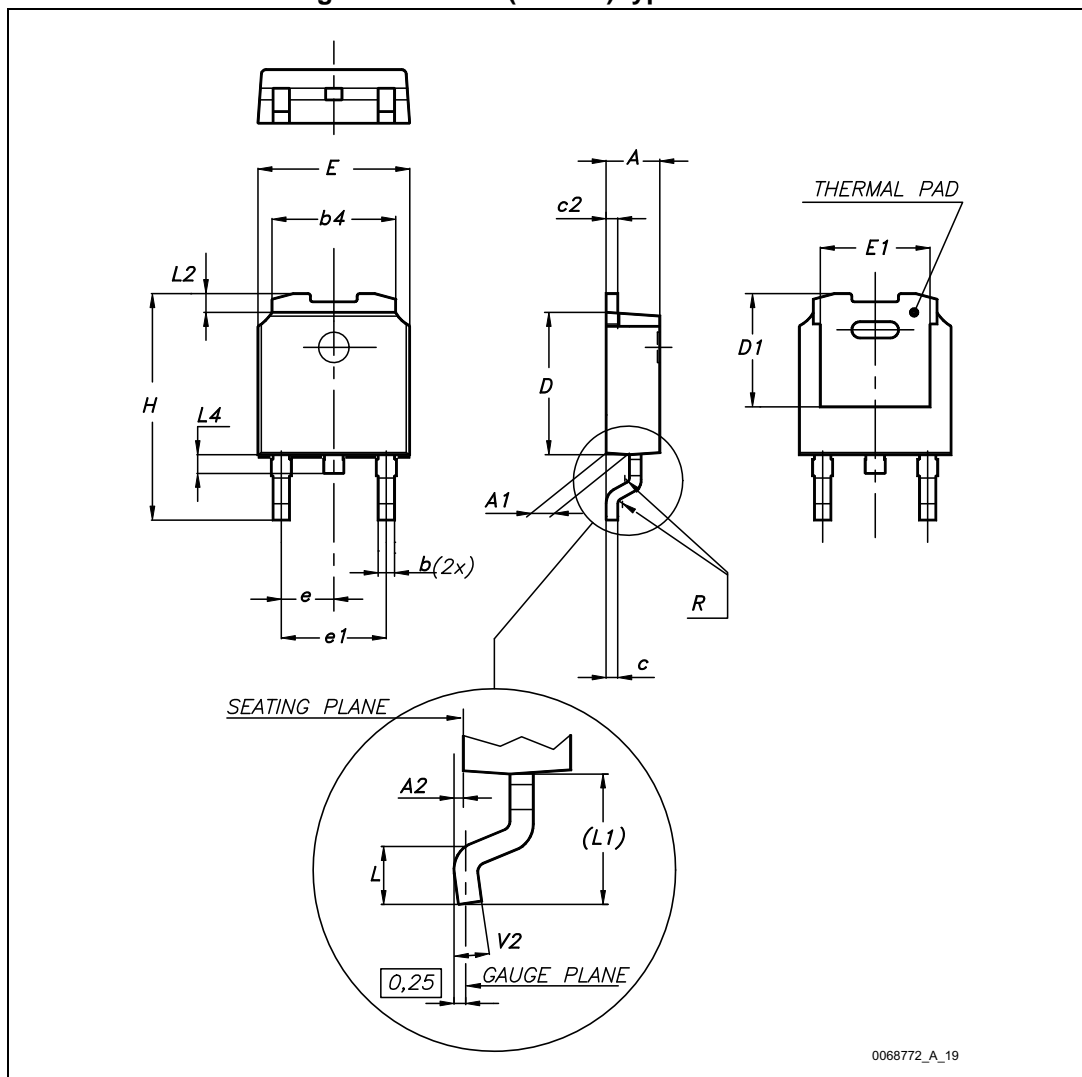
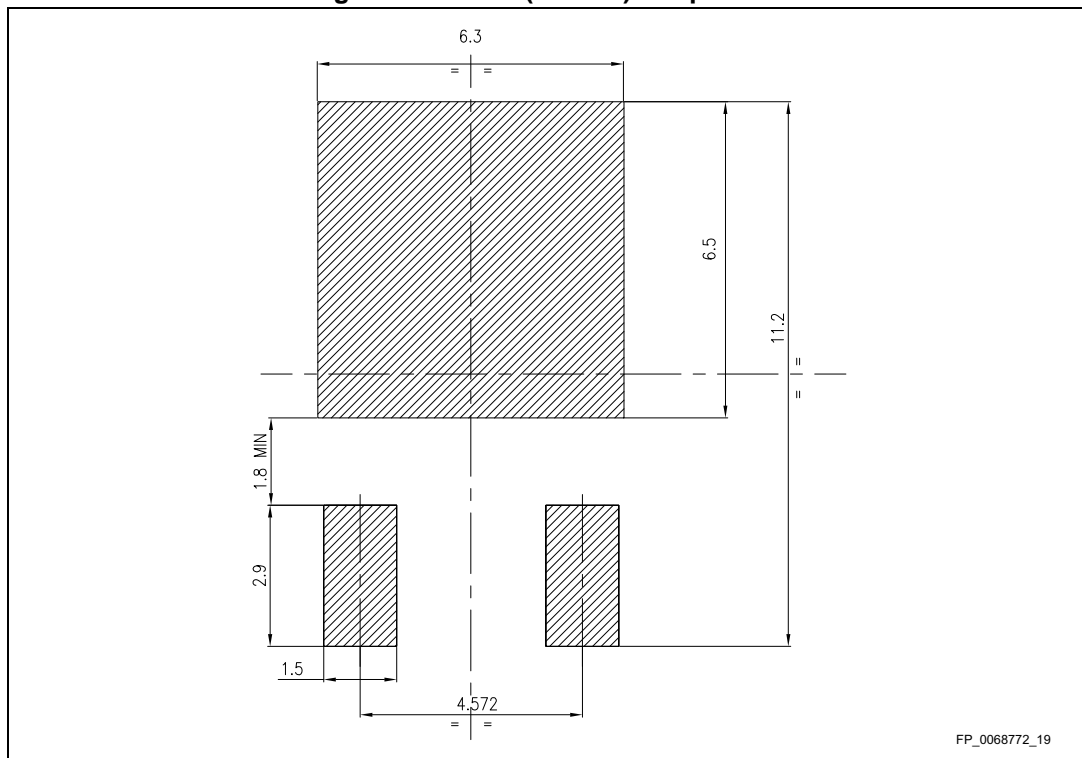

Table 9. DPAK (TO-252) type A mechanical data

Dim.	mm		
	Min.	Typ.	Max.
A	2.20		2.40
A1	0.90		1.10
A2	0.03		0.23
b	0.64		0.90
b4	5.20		5.40
c	0.45		0.60
c2	0.48		0.60
D	6.00		6.20
D1	4.95	5.10	5.25
E	6.40		6.60
E1	4.60	4.70	4.80
e	2.16	2.28	2.40
e1	4.40		4.60
H	9.35		10.10
L	1.00		1.50
(L1)	2.60	2.80	3.00
L2	0.65	0.80	0.95
L4	0.60		1.00
R		0.20	
V2	0°		8°

Figure 26. DPAK (TO-252) footprint (a)



a. All dimensions are in millimeters

## 4.2 TO-220FP package information

Figure 27. TO-220FP package outline

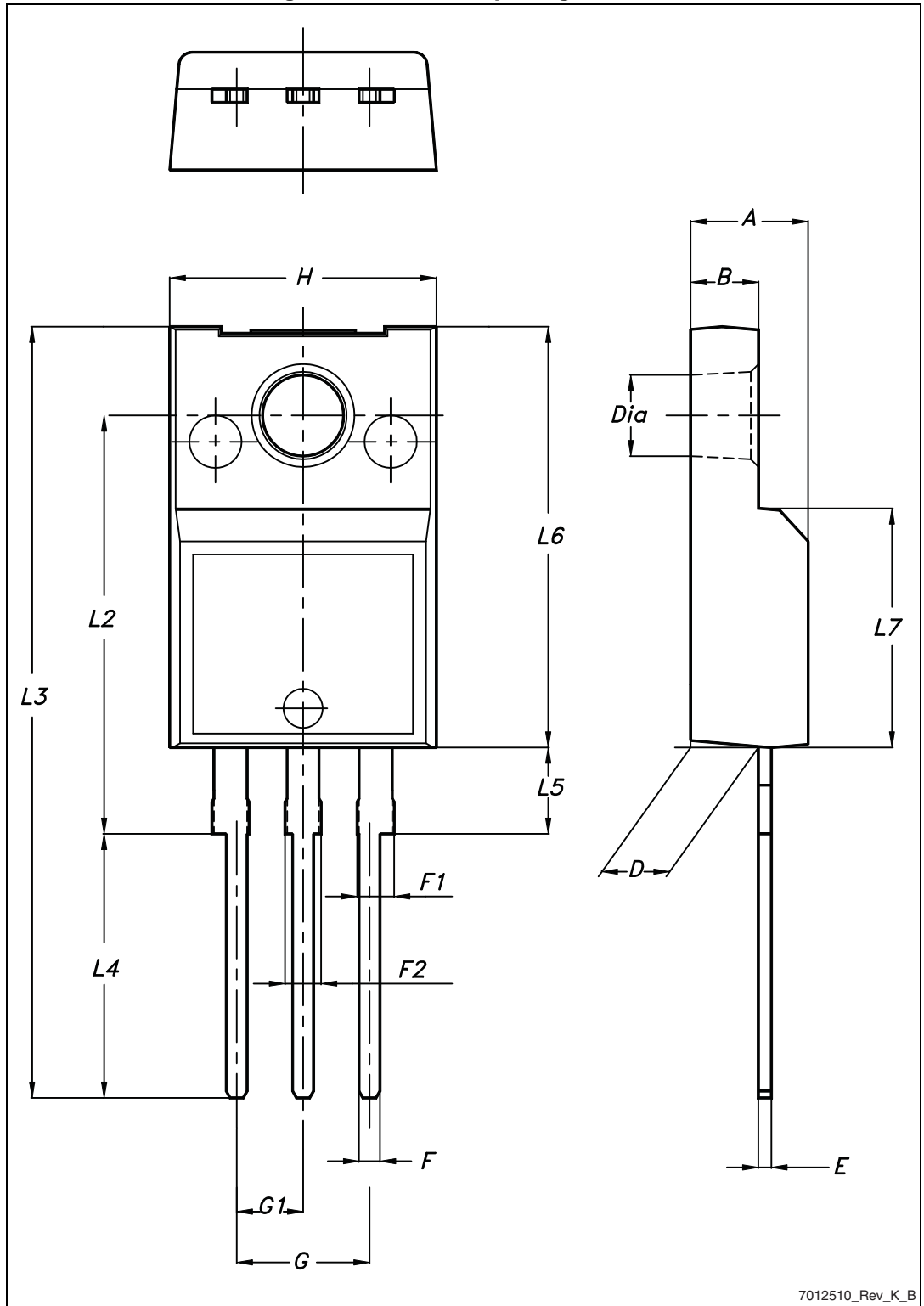

7012510\_Rev\_K\_B

Table 10. TO-220FP package mechanical data

Dim.	mm		
	Min.	Typ.	Max.
A	4.4		4.6
B	2.5		2.7
D	2.5		2.75
E	0.45		0.7
F	0.75		1
F1	1.15		1.70
F2	1.15		1.70
G	4.95		5.2
G1	2.4		2.7
H	10		10.4
L2		16	
L3	28.6		30.6
L4	9.8		10.6
L5	2.9		3.6
L6	15.9		16.4
L7	9		9.3
Dia	3		3.2

### 4.3 TO-220 package information

Figure 28. TO-220 package outline

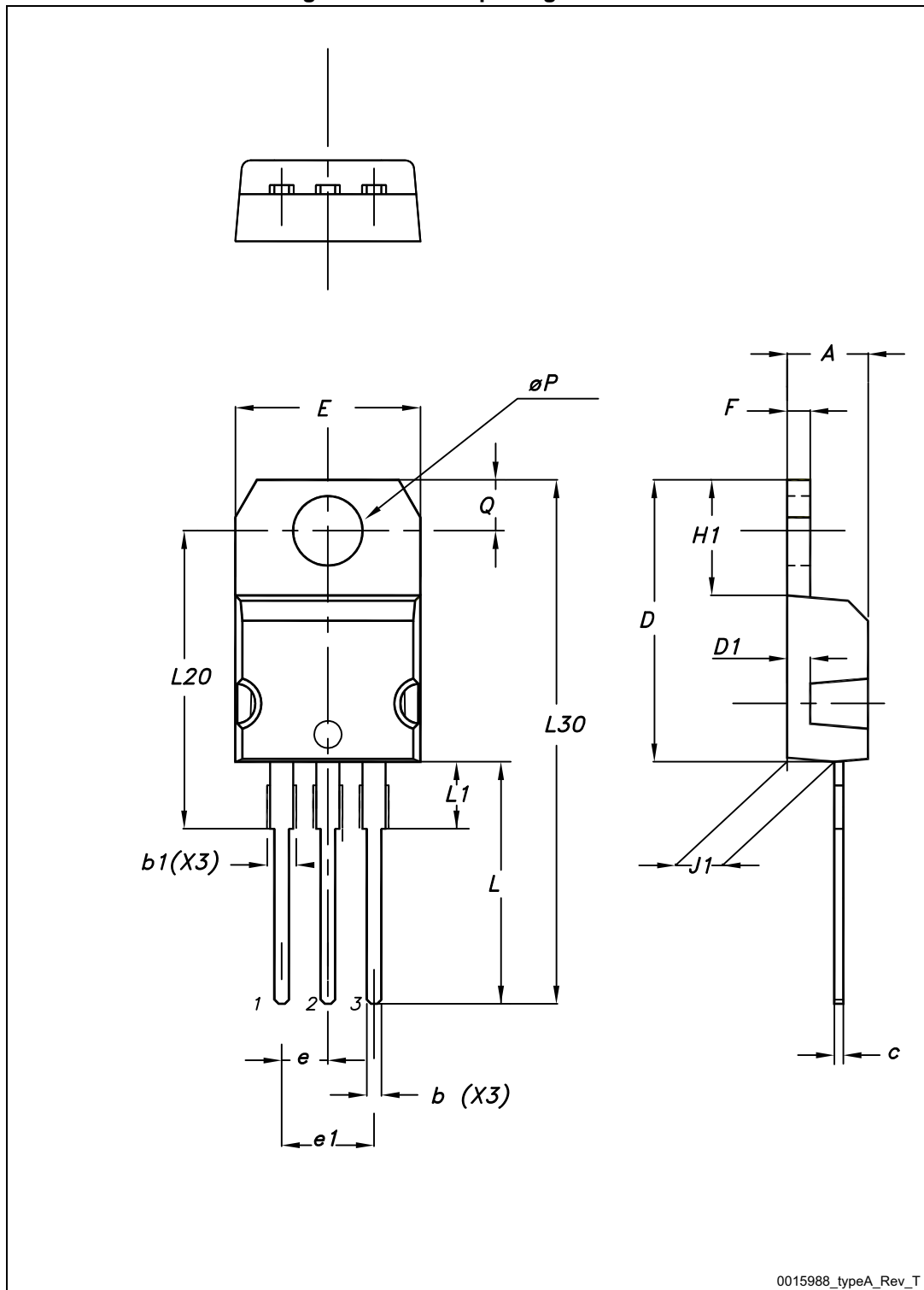

Table 11. TO-220 package mechanical data

Dim.	mm		
	Min.	Typ.	Max.
A	4.40		4.60
b	0.61		0.88
b1	1.14		1.70
c	0.48		0.70
D	15.25		15.75
D1		1.27	
E	10		10.40
e	2.40		2.70
e1	4.95		5.15
F	1.23		1.32
H1	6.20		6.60
J1	2.40		2.72
L	13		14
L1	3.50		3.93
L20		16.40	
L30		28.90	
ØP	3.75		3.85
Q	2.65		2.95



### 4.4 IPAK (TO-251) type A package information

Figure 29. IPAK (TO-251) type A package outline

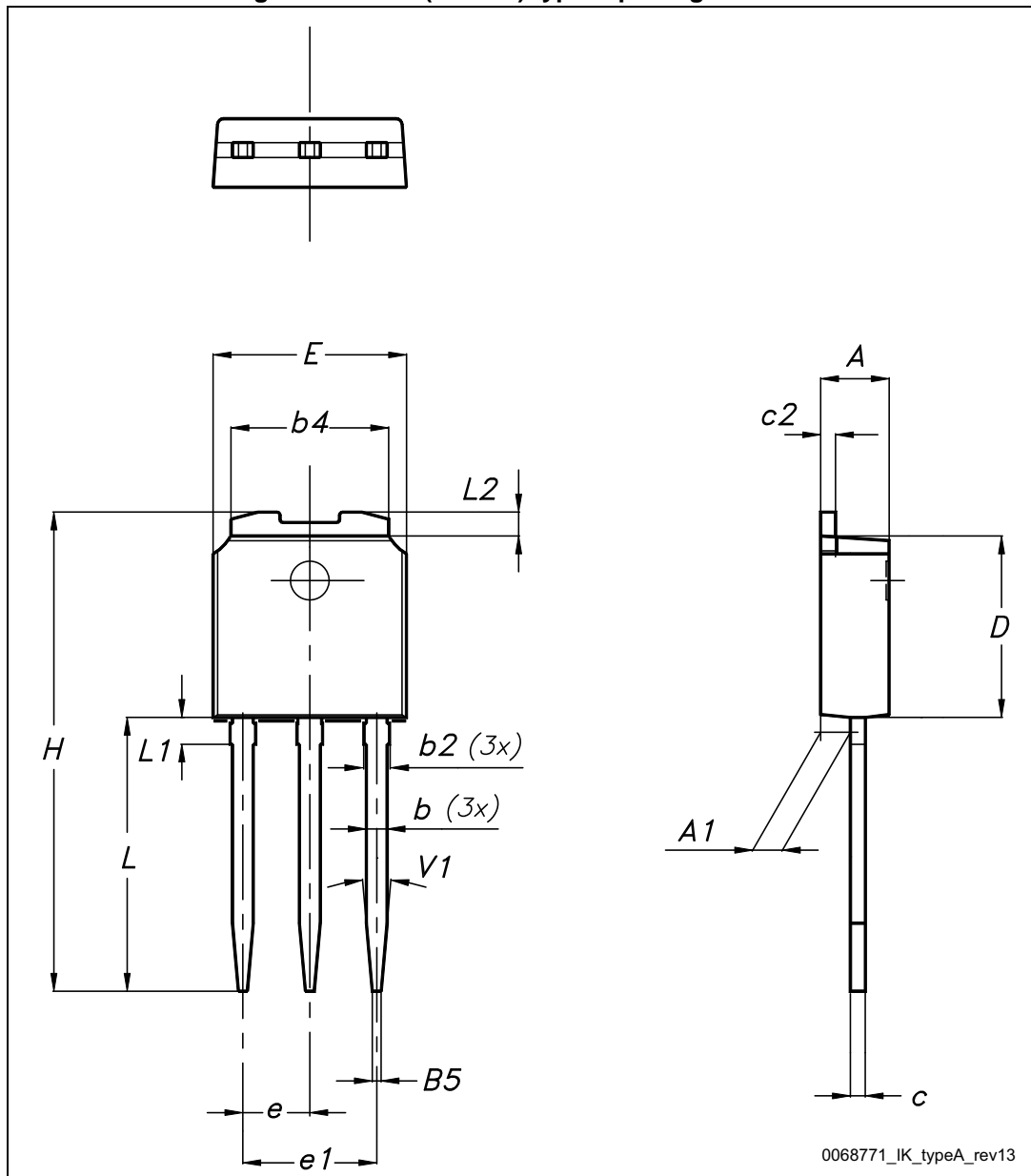

Table 12. IPAK (TO-251) type A package mechanical data

DIM	mm.		
	min.	typ.	max.
A	2.20		2.40
A1	0.90		1.10
b	0.64		0.90
b2			0.95
b4	5.20		5.40
B5		0.30	
c	0.45		0.60
c2	0.48		0.60
D	6.00		6.20
E	6.40		6.60
e		2.28	
e1	4.40		4.60
H		16.10	
L	9.00		9.40
L1	0.80		1.20
L2		0.80	1.00
V1		10°	

# 5 Packaging information

Figure 30. Tape for DPAK

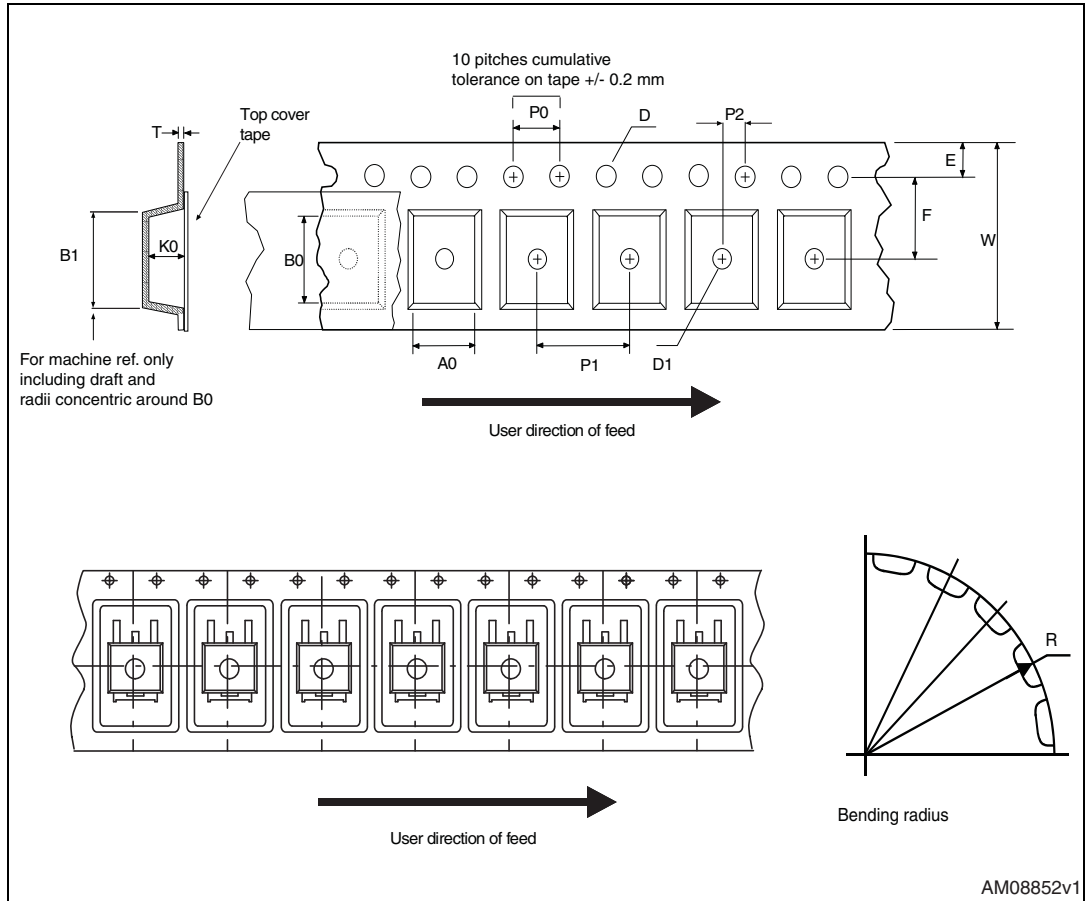

Figure 31. Reel for DPAK

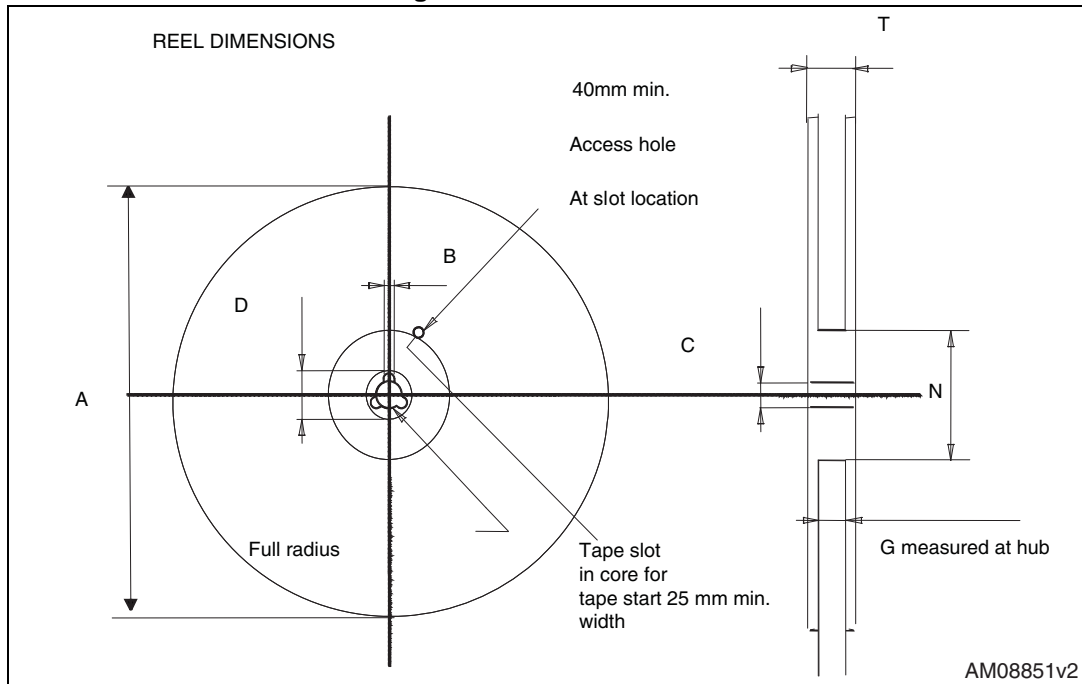

Table 13. DPAK tape and reel mechanical data

Tape			Reel		
Dim.	mm		Dim.	mm	
	Min.	Max.		Min.	Max.
A0	6.8	7	A		330
B0	10.4	10.6	B	1.5	
B1		12.1	C	12.8	13.2
D	1.5	1.6	D	20.2	
D1	1.5		G	16.4	18.4
E	1.65	1.85	N	50	
F	7.4	7.6	T		22.4
K0	2.55	2.75			
P0	3.9	4.1		Base qty.	2500
P1	7.9	8.1		Bulk qty.	2500
P2	1.9	2.1			
R	40				
T	0.25	0.35			
W	15.7	16.3			

## 6 Revision history

**Table 14. Document revision history**

Date	Revision	Changes
11-Jul-2013	1	First release.
18-Feb-2014	2	<ul style="list-style-type: none"> <li>– Added: IPAK package</li> <li>– Modified: <math>E_{AS}</math> value in <i>Table 2</i></li> <li>– Modified: <math>R_{thj-case}</math> in <i>Table 3</i></li> <li>– Modified: typical values in <i>Table 5, 6 and 7</i></li> <li>– Added: <i>Section 2.1: Electrical characteristics (curves)</i></li> <li>– Updated: <i>Figure 25, 26 and Table 9</i></li> <li>– Added: <i>Table 12 and Figure 29</i></li> <li>– Minor text changes</li> </ul>
25-Sep-2015	3	<ul style="list-style-type: none"> <li>– Updated title, features and description in cover page.</li> <li>– Updated <i>Figure 10, Figure 11</i> and <i>Section 4: Package information</i>.</li> <li>– Minor text changes.</li> </ul>

**IMPORTANT NOTICE – PLEASE READ CAREFULLY**

STMicroelectronics NV and its subsidiaries ("ST") reserve the right to make changes, corrections, enhancements, modifications, and improvements to ST products and/or to this document at any time without notice. Purchasers should obtain the latest relevant information on ST products before placing orders. ST products are sold pursuant to ST's terms and conditions of sale in place at the time of order acknowledgement.

Purchasers are solely responsible for the choice, selection, and use of ST products and ST assumes no liability for application assistance or the design of Purchasers' products.

No license, express or implied, to any intellectual property right is granted by ST herein.

Resale of ST products with provisions different from the information set forth herein shall void any warranty granted by ST for such product.

ST and the ST logo are trademarks of ST. All other product or service names are the property of their respective owners.

Information in this document supersedes and replaces information previously supplied in any prior versions of this document.

© 2015 STMicroelectronics – All rights reserved