



# i150-RP313

i150RP

SAFETY COMMAND DEVICES

**SICK**  
Sensor Intelligence.



### Ordering information

Type	Part no.
i150-RP313	6024883

Other models and accessories → [www.sick.com/i150RP](http://www.sick.com/i150RP)



### Detailed technical data

#### Features

<b>Number of positive action N/C contacts</b>	3
<b>Number of N/O contacts</b>	1
<b>Actuation force (deflection)</b>	≤ 125 N (300 mm)
<b>Actuation frequency</b>	≤ 3,600 /h
<b>Actuation directions</b>	1
<b>Cord length</b>	≤ 75 m

#### Safety-related parameters

<b>B<sub>10d</sub> parameter</b>	2 x 10 <sup>6</sup> switching cycles (with small load)
<b>Safe state in the event of a fault</b>	The switch has no internal fault detection and is unable to assume a safe state in the event of a fault. Fault detection is performed by the connected safety-related logic unit.

#### Functions

<b>Safe series connection</b>	None, only individual wiring (with diagnostics)
-------------------------------	---

#### Interfaces

<b>Connection type</b>	Cable gland, 3 x M20
Conductor cross-section	≤ 1.5 mm <sup>2</sup>

#### Electrical data

<b>Switching principle</b>	Slow action switching element
<b>Number of positive action N/C contacts</b>	3
<b>Number of N/O contacts</b>	1
<b>Usage category</b>	AC-15/DC-13 (IEC 60947-5-1)
<b>Rated operating current (voltage)</b>	3 A (240 V AC) 2 A (24 V DC)
<b>Rated insulation voltage U<sub>i</sub></b>	250 V
<b>Rated impulse withstand voltage U<sub>imp</sub></b>	2,500 V

<b>Short-circuit protection</b>	T6
<b>Switching voltage</b>	≥ 5 V DC
<b>Switching current (switching voltage)</b>	≥ 5 mA (5 V DC)

#### Mechanical data

<b>Dimensions</b>	69 mm x 203 mm x 85 mm
<b>Weight</b>	0.84 kg
<b>Housing material</b>	Die cast lightweight metal
<b>Surface treatment</b>	Varnished
<b>Mechanical life</b>	1 x 10 <sup>6</sup> switching cycles

#### Ambient data

<b>Enclosure rating</b>	IP65 (IEC 60529)
<b>Ambient operating temperature</b>	-25 °C ... +80 °C
<b>Storage temperature</b>	-25 °C ... +80 °C

#### Classifications

<b>eCl@ss 5.0</b>	27270601
<b>eCl@ss 5.1.4</b>	27270690
<b>eCl@ss 6.0</b>	27270607
<b>eCl@ss 6.2</b>	27270607
<b>eCl@ss 7.0</b>	27270607
<b>eCl@ss 8.0</b>	27270607
<b>eCl@ss 8.1</b>	27270607
<b>eCl@ss 9.0</b>	27270607
<b>eCl@ss 10.0</b>	27270607
<b>eCl@ss 11.0</b>	27270607
<b>eCl@ss 12.0</b>	27270607
<b>ETIM 5.0</b>	EC002033
<b>ETIM 6.0</b>	EC002033
<b>ETIM 7.0</b>	EC002033
<b>ETIM 8.0</b>	EC002033
<b>UNSPSC 16.0901</b>	39121545

Dimensional drawing (Dimensions in mm (inch))

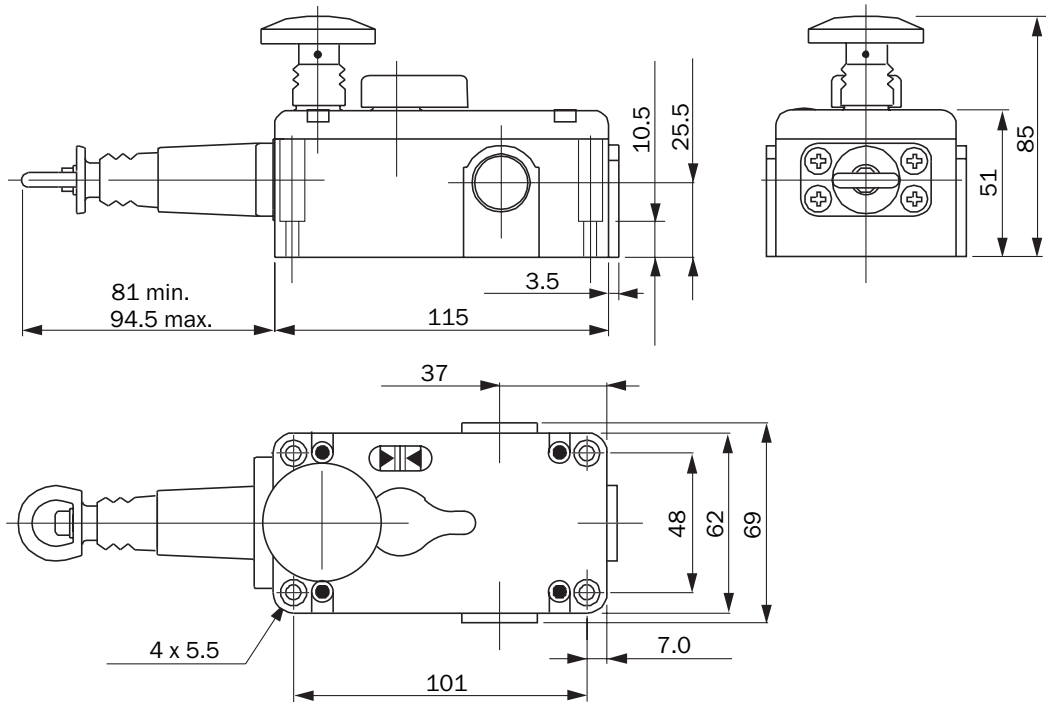

Actuator travel diagram

Contact action over the entire actuator withdrawal distance (full insertion = 0 mm)

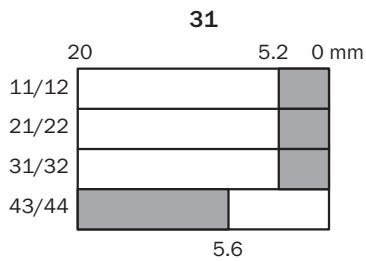
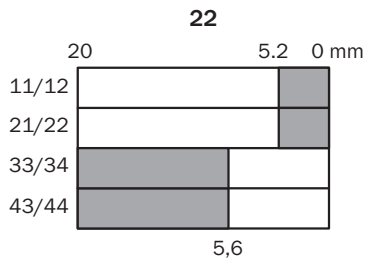

- Contacts open
- Contacts closed

## Switching elements

	Rope stack	Rope tensioned	Rope pulled
Switching element 22			
Switching element 31			

### Switching element 22:

2 positive action N/C contacts + 2 N/O contact

### Switching element 31:

3 positive action N/C contacts + 1 N/O contact

## SICK AT A GLANCE

SICK is one of the leading manufacturers of intelligent sensors and sensor solutions for industrial applications. A unique range of products and services creates the perfect basis for controlling processes securely and efficiently, protecting individuals from accidents and preventing damage to the environment.

We have extensive experience in a wide range of industries and understand their processes and requirements. With intelligent sensors, we can deliver exactly what our customers need. In application centers in Europe, Asia and North America, system solutions are tested and optimized in accordance with customer specifications. All this makes us a reliable supplier and development partner.

Comprehensive services complete our offering: SICK LifeTime Services provide support throughout the machine life cycle and ensure safety and productivity.

For us, that is “Sensor Intelligence.”

## WORLDWIDE PRESENCE:

Contacts and other locations –[www.sick.com](http://www.sick.com)