

A Series 1-4 Pole Rotary Switches

Features/Benefits

- Multi-pole and multi-position
- Positive detent
- Shorting & non-shorting contacts
- Panel and PCB mounting
- RoHS Compliant



Models Available

Typical Applications

- Automotive
- Major and small appliances
- Industrial equipment



Specifications

CONTACT RATING: Q contact material: Switch - 2.5 AMPS @ 125 V AC; 1 AMP @ 250 V AC; 350 mA @ 125 V DC (UL/CSA). Carry - 5 AMPS continuous. See page K-6 for additional ratings.

ELECTRICAL LIFE: Up to 15,000 make-and-break cycles at full load up to 300,000 detent operations.

CONTACT RESISTANCE: Below 20 m Ω typ. initial @ 2-4 V DC, 100 mA, for both silver and gold plated contacts.

INSULATION RESISTANCE: 10⁹ Ω min.

DIELECTRIC STRENGTH: 1,000 Vrms min. @ sea level.

Operating and storage temp: -30° to 85°C

OPERATING & STORAGE TEMPERATURE: -30°C to 85°C

NOTE: Any models supplied with Q, B or G contact material are RoHS compliant.

NOTE: Specifications and materials listed above are for switches with standard options. For information on specific and custom switches, consult Customer Service Center.

Materials

HOUSING & BUSHING: Glass filled 6/6 nylon (UL 94V-0).

ACTUATOR: Glass filled 6/6 nylon (UL 94V-0).

MOVABLE CONTACTS: Q contact material: Coin silver, silver plated. See page K-6 for additional contact materials.

STATIONARY CONTACTS & TERMINALS: Q contact material: Brass, silver plated. See page K-6 for additional contact materials.

HARDWARE: Nut - zinc, nickel plated. Lockwasher — steel, bright zinc plated. Stop Ring - brass, nickel plated.

TERMINAL SEAL: Epoxy.

Build-A-Switch

To order, simply select desired option from each category and place in the appropriate box. Available options are shown and described on pages K-4 through K-7. For additional options not shown in catalog, consult Customer Service Center.

<p>Switch Function</p> <p>A100 SP, 30° Index, 12 pos. no stops</p> <p>A102 SPDT, 30° Index</p> <p>A103 SP, 30° Index, 3 pos.</p> <p>A104 SP, 30° Index, 4 pos.</p> <p>A105 SP, 30° Index, 5 pos.</p> <p>A106 SP, 30° Index, 6 pos.</p> <p>A107 SP, 30° Index, 7 pos.</p> <p>A108 SP, 30° Index, 8 pos.</p> <p>A109 SP, 30° Index, 9 pos.</p> <p>A110 SP, 30° Index, 10 pos.</p> <p>A112 SP, 30° Index, 12 pos.</p> <p>A114 SP, 90° Index, 2 pos.</p> <p>A115 SP, 45° Index, 3 pos.</p> <p>A124 SP, 90° Index, 4 pos.</p> <p>A125 SP, 45° Index, 8 pos.</p> <p>A203 DP, 30° Index, 3 pos.</p> <p>A204 DP, 30° Index, 4 pos.</p> <p>A205 DP, 30° Index, 5 pos.</p> <p>A206 DP, 30° Index, 6 pos.</p> <p>A214 DP, 90° Index, 2 pos.</p> <p>A303 3P, 30° Index, 3 pos.</p> <p>A304 3P, 30° Index, 4 pos.</p> <p>A402 4PDT, 30° Index</p> <p>A403 4P, 30° Index, 3 pos</p>	<p>Actuator</p> <p>15 1.500" high, flatted</p> <p>03 .375" high, flatted</p> <p>05 .500" high, flatted</p> <p>14 1.500" high, flatted</p> <p>42 1.654" high, metric</p> <p>S1 Screwdriver Slot</p>	<p>Mounting Style</p> <p>R 3/8-32 threaded</p> <p>M M10 x .75 metric</p>	<p>Shorting/ Non-shorting Contacts</p> <p>N Non-shorting contacts</p> <p>S Shorting contacts (Not available with models A114, A124 & A214)</p>	<p>Terminations</p> <p>Z Solder lug</p> <p>C PC Thru-hole</p> <p>MC Modular base</p>	<p>Contact Material</p> <p>Q Silver</p> <p>B Gold</p> <p>G Gold over silver</p>	<p>Seal</p> <p>NONE No seal</p> <p>E Epoxy seal</p> <p>F Splashproof bushing seal</p> <p>K Epoxy & splashproof bushing seal</p>
--	---	---	---	--	---	--



K

Rotary

A Series 1-4 Pole Rotary Switches

SWITCH FUNCTION

30° INDEXING			
NO. POLES	MODEL NO.	SWITCH FUNCTION	TERMINALS
SP	A100	12 Position No Stops	A,1-12
	A102	SPDT	A,1,2*
	A103	3 Position	A,1-3*
	A104	4 Position	A,1-4*
	A105	5 Position	A,1-5*
	A106	6 Position	A,1-6*
	A107	7 Position	A,1-7
	A108	8 Position	A,1-8
	A109	9 Position	A,1-9
	A110	10 Position	A,1-10
A112	12 Position	A,1-12	
DP	A203	3 Position	A,C,1-3,7-9
	A204	4 Position	A,C,1-4,7-10
	A205	5 Position	A,C,1-5,7-11
	A206	6 Position	A,C,1-12
3P	A303	3 Position	A,B,C,1-3,5-7,9-11
	A304	4 Position	A,B,C,1-12

SP MODELS SCHEMATIC

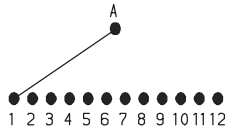

DP MODELS SCHEMATIC

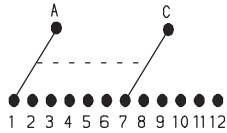

3P MODELS SCHEMATIC

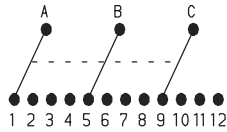

4P MODELS SCHEMATIC

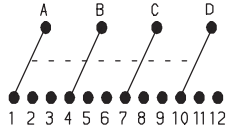

30° INDEXING			
NO. POLES	MODEL NO.	SWITCH FUNCTION	TERMINALS
4P	A402	4PDT	A,B,C,D,1,2,4,5,7,8,10,11
	A403	3 Position	All Terminals

45° INDEXING			
NO. POLES	MODEL NO.	SWITCH FUNCTION	TERMINALS
SP	A115	3 Position	A,1,2,4*
	A125	8 Position	A,1,2,4,5,7,8,10,11

90° INDEXING			
NO. POLES	MODEL NO.	SWITCH FUNCTION	TERMINALS
SP	A114	2 Position	A,1,4*
	A124	4 Position	A,1,4,7,10
DP	A214	2 Position	A,C,1,4,7,10

TERMINAL NUMBERS

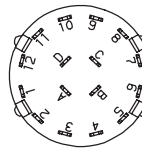

Terminal numbers molded on bottom of housing.

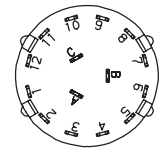

3P MODELS

NOTE: * These models with 'C' or 'MC' terminations have additional terminal no. 9 as switch support only. This terminal is not connected electrically inside switch.

All models  with all options when ordered with 'G' or 'Q' contact material, see page K-6.

4P MODELS
SP MODELS (omit terminals B, C & D)
DP MODELS (omit terminals B & D)

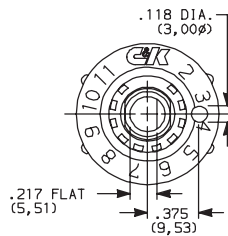

TERM. NOS. MOLDED ON HOUSING



Dimensions are shown: Inch (mm)
Specifications and dimensions subject to change

A Series 1-4 Pole Rotary Switches

ACTUATOR

15 1.500" HIGH

03 .375" HIGH

05 .500" HIGH

14 1.500" HIGH

42 1.654" METRIC

S1 SCREWDRIVER SLOT



NOTE: Actuators shown in position 1, fully CCW.

MOUNTING STYLE

R 3/8-32 THREAD

M M10 x .75 METRIC



PANEL MOUNTING



PANEL MOUNTING



TYPICAL INSTALLATION

Maximum force to push on knob should not exceed 10 lbs.

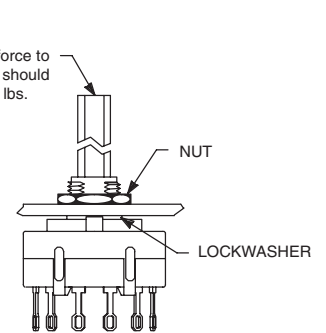

Install switch with stop ring (if used) and lockwasher in back of panel. Tighten hex nut from front of panel.

On PC mounted switches, use hex nut and lockwasher to hold stop ring in place.

Actuation torque: 8-16 oz./in.
Maximum torque: 30 oz./in.

SHORTING/NON-SHORTING CONTACTS

N NON-SHORTING CONTACTS (break-before-make)

S SHORTING CONTACTS (make-before-break)

NOTE: 'S' shorting contacts are not available with A114, A124 and A214 models.

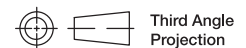

Dimensions are shown: Inch (mm)
Specifications and dimensions subject to change

A Series 1-4 Pole Rotary Switches

TERMINATIONS

Z SOLDER LUG

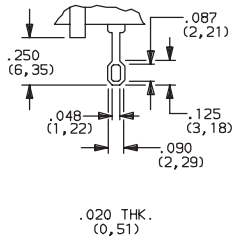

C PC THRU-HOLE

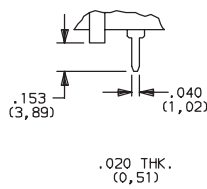

MC MODULAR BASE (for wave soldering)

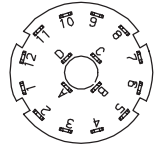
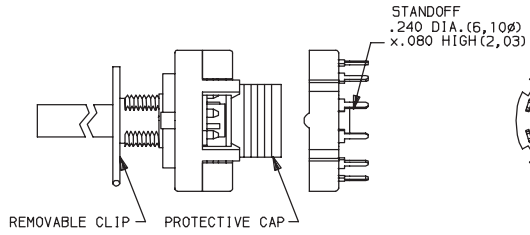

NOTE: Switches with 'C' or 'MC' terminations have additional terminal no. 9 as switch support only. This terminal is not connected electrically inside switch. Solder and clean switch base on PC board with other components, then snap on housing/actuator assembly. See page K-7 for installation instructions.

PC MOUNTING

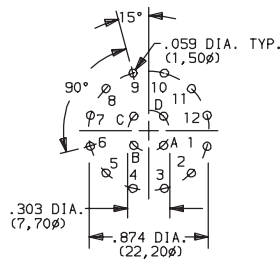

4P MODEL
SP MODEL (omit terminals B, C & D)
DP MODEL (omit terminals B & D)

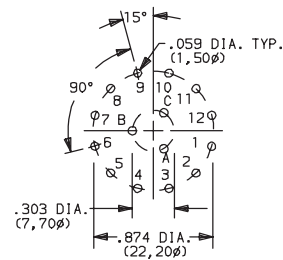

3P MODEL

CONTACT MATERIAL

Option Code	Contact & Terminal Material	Typical Usage	Rating	Cycles
Q	Silver ²	Power	SWITCH – 2.5 AMPS @ 125 VAC; 1 AMP @ 250 VAC (UL/CSA) CARRY – 5 AMPS CONTINUOUS	6,000
			SWITCH – 350 mA @ 125 VDC (UL/CSA) CARRY – 5 AMPS CONTINUOUS	15,000
B	Gold ¹	Low level/ Dry circuit	0.4 VA MAX. @ 20 V AC OR DC MAX	15,000
G	Gold over silver ³	Low level/ Dry circuit or power	0.4 VA MAX. @ 20 V AC OR DC MAX	15,000
			SWITCH – 350 mA @ 125 VDC (UL/CSA) CARRY – 5 AMPS CONTINUOUS	15,000
			SWITCH – 2.5 AMPS @ 125 VAC; 1 AMP @ 250 VAC (UL/CSA) CARRY – 5 AMPS CONTINUOUS	6,000

* Note: See Technical Data section of this catalog for RoHS compliant and compatible definition and specifications.

- ¹ MOVABLE CONTACTS: Copper alloy, with gold plate over nickel plate.
STATIONARY CONTACTS & TERMINALS: Brass, with gold plate over nickel plate.
² MOVABLE CONTACTS: Coin silver, silver plated.
STATIONARY CONTACTS & TERMINALS: Brass, silver plated (standard with all termination options).
³ MOVABLE CONTACTS: Coin silver, with gold plate over nickel plate over silver plate.
STATIONARY CONTACTS & TERMINALS: Brass, with gold plate over nickel plate over silver plate.

NOTE: Any models supplied with Q, B or G contact material are RoHS compliant.

All models  with all options when ordered with 'G' or 'Q' contact material.

NOTE: 'G' contact material is equivalent to both 'B' and 'Q' contact materials.



Third Angle Projection

Dimensions are shown: Inch (mm)
Specifications and dimensions subject to change

A Series 1-4 Pole Rotary Switches

FUNCTION

NONE NO SEAL

E EPOXY SEAL

F SPLASHPROOF BUSHING SEAL

K EPOXY & SPLASHPROOF BUSHING SEAL



Setting Stops on A112 and A125 Models

The number of switch positions is adjustable on A112 and A125 models only by means of a stop ring provided with each switch. The number of positions is pre-set on all other models and the stop ring is factory installed.

To set stops: Turn shaft fully counter-clockwise and insert stop ring tab in desired hole. Install lockwasher and nut to retain stop ring for both PC and panel mounting. Switch without stop ring has 12 positions.

Soldering, Cleaning and Assembly Instructions for 'MC' Termination Option

Soldering

1. Insert switch base only into PC board.
2. Do not bend terminals.
3. Wave soldering recommended at 500F solder temperature.
4. Hand solder at 500F, 10 sec. max./terminal.

Cleaning

1. Flux clean using vapor degreaser and forced rinse or triple bath method.
2. Do not allow switch base to 'trap' fluids.
3. Freon TMC, TF or Methylene Chloride give excellent results.

Switch Assembly

1. Hold housing/shaft assembly by housing. Remove protective cap by squeezing tabs and discard. (FIG. 1)
2. Do not push on switch shaft. Detent mechanism will come apart.
3. While holding switch housing, align locating tab on base with notch on housing and engage 4 housing latches in slots on base. (FIG. 2)
4. Push firmly on housing until latches snap in place.
5. Remove clip from shaft and discard. Assembly is complete. (FIG. 3)



AVAILABLE HARDWARE

Stop ring



PART NO.
767B00201

Material: Brass
Finish: Nickel plated



Dimensions are shown: Inch (mm)
Specifications and dimensions subject to change