

## General Description

The MAX20051 evaluation kit (EV kit) demonstrates the MAX20051 and MAX20053, 2A synchronous buck LED drivers with integrated MOSFETs.

The EV kit operates from a DC supply voltage from 4.5V to 65V and the switching frequency is fixed at 400kHz. Spread-spectrum mode (SSM) is enabled for EMI improvement. The EV kit demonstrates both analog and pulse-width modulation (PWM) dimming. The EV kit also demonstrates short LED, open LED, and overtemperature-fault protection.

The EV kit also comes with a MAX20053 IC, which can be installed to evaluate the 2.1MHz switching frequency device. Refer to the *Evaluating the MAX20053* section for more information.

## Features and Benefits

- 4.5V to 65V Input Voltage
- Drives 1 to 16 LEDs
- 0A to 2A LED Current
- Demonstrates Undervoltage-Lockout and Output-Short Protection
- Demonstrates Current-Limit and Thermal-Shutdown Feature
- Demonstrates 5V, 10mA LDO Output Capability
- Proven PCB Layout and Thermal Design
- Fully Assembled and Tested

Ordering Information appears at end of data sheet.

## MAX20051 EV Kit Photo

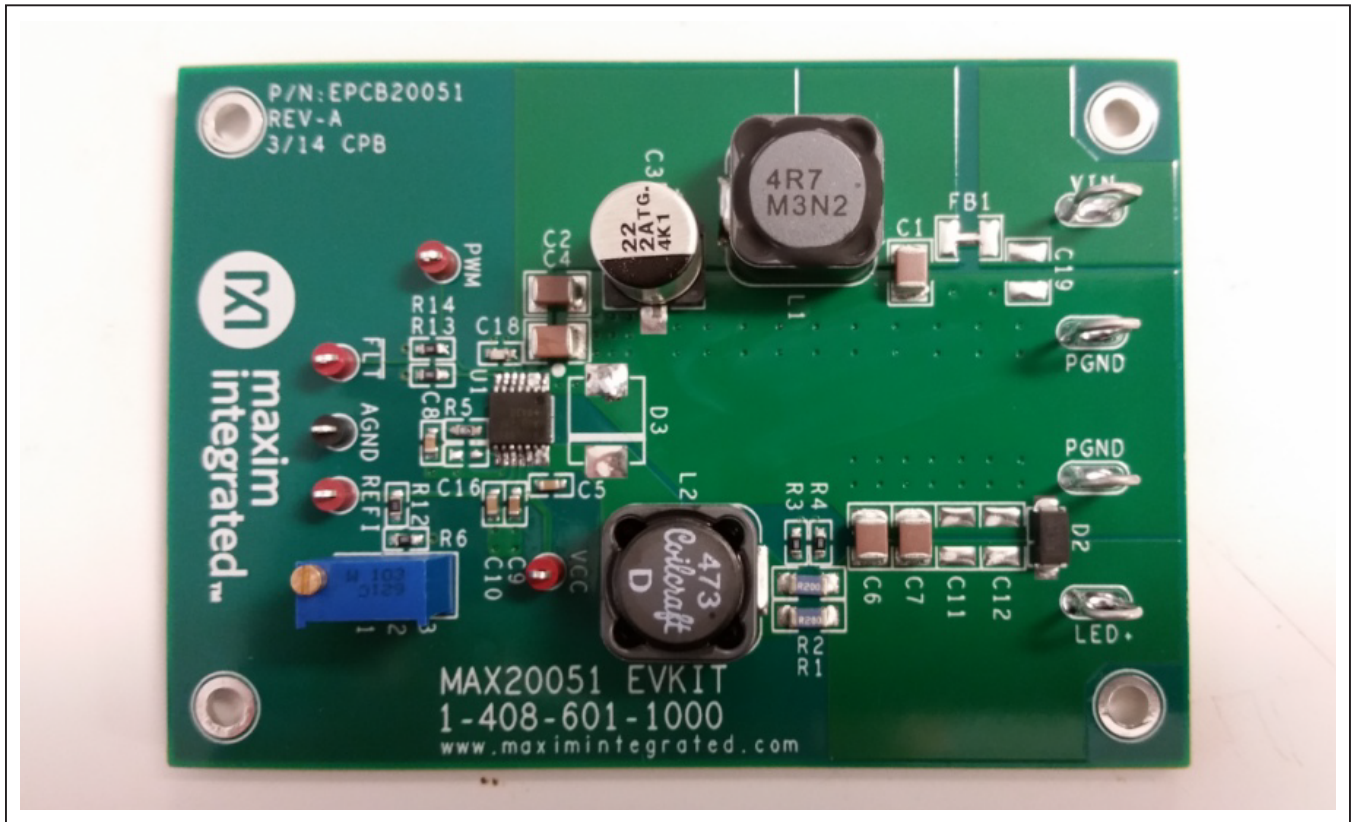

## Quick Start

### Required Equipment

- MAX20051 EV kit
- 5V to 65V, 4A DC power supply
- Two digital voltmeters (DVMs)
- One series-connected HB LED string rated to no less than 2.5A
- Current probe to measure the HB LED current
- Small flat-blade screwdriver to turn the potentiometer wiper-adjustment pin

### Procedure

The EV kit is fully assembled and tested. Follow the steps below to verify board operation:

- 1) Connect the HB LED string anode to the LED+ PCB pad and the cathode to the PGND PCB pad.
- 2) Connect the first DVM across the LED+ and PGND PCB pads.
- 3) Connect the second DVM across the REF1 test point and AGND test point.
- 4) Connect the power supply to the VIN PCB pad and the power supply's ground to the PGND PCB pad.
- 5) Clip the current probe across the wire connecting the HB LED string to the EV kit.
- 6) Turn on the power supply and set it to a voltage greater than the maximum HB LED string voltage, but less than the 65V maximum input voltage.
- 7) Use the screwdriver to turn the potentiometer until the second DVM reads 1.2V.
- 8) Measure the HB LED current using the current probe and verify that the current is 2A.
- 9) Verify that the first DVM shows the expected LED string voltage.
- 10) Use the screwdriver to turn the potentiometer until the second DVM reads 0.7V.
- 11) Measure the HB LED current using the current probe and verify that the current is 1A.

## Detailed Description of Hardware

The MAX20051 EV kit demonstrates the MAX20051 2A synchronous buck LED driver with integrated MOSFETs. The device consists of a fully synchronous step-down converter with integrated MOSFETs and is capable of driving a series string of LEDs at up to 2A, with a minimum number of external components. The device is a fixed-

frequency average current-mode step-down LED driver. The device uses high-side current regulation, meaning a current-sense resistor is placed on the high side of the LED string, and the voltage across the current-sense resistor is sensed and used to regulate the LED current. The device offers both analog and PWM dimming.

### Analog Dimming

The EV kit demonstrates the analog dimming feature of the device. R6 and R7 form a resistor-divider between VCC and AGND. R6 is a 10k $\Omega$  resistor and R7 is a 10k $\Omega$  potentiometer, with the wiper shorted to the high side of the potentiometer. Using a flat-blade screwdriver, turn the wiper-adjustment pin clockwise to increase the voltage on the REF1 input. Turn the wiper-adjustment pin counter-clockwise to decrease the voltage on the REF1 input. The REF1 input allows for analog dimming of the HB LED string. A REF1 input voltage of 0.2V or less turns off the LED driver. A REF1 input voltage between 0.2V and 1.2V provides linear dimming of the HB LED string. A REF1 input voltage greater than 1.2V sets the HB LED string current to maximum current (based on the current-sense resistor).

Alternatively, the analog dimming input can be set with a power supply. Remove R12 and connect the power supply directly to the REF1 test point to perform analog dimming with a power supply. Be careful not to violate the absolute maximum voltage rating of  $V_{CC} + 0.3V$  (refer to the *Absolute Maximum Ratings* section in the MAX20050–MAX20053 IC data sheet).

### PWM Dimming

The EV kit demonstrates the PWM dimming feature of the device. Connect a PWM signal to the PWM test point. Vary the duty cycle to increase or decrease the intensity of the HB LED string. The PWM input of the device has 2V (max) rising threshold and a 0.8V (min) falling threshold so it is compatible with 3.3V and 5V logic-level signals. The PWM input is pulled up to  $V_{CC}$  through an external 10k $\Omega$  resistor on the EV kit.

### Fault Indicator

The EV kit demonstrates the fault-protection features of the device. The device offers shorted LED, open LED, and overtemperature protection. The  $\overline{FLT}$  output is an open-drain, active-low fault indicator. Refer to the *Fault Pin Behavior* section in the MAX20050–MAX20053 IC data sheet for more information.

### Acoustic Noise

High input voltage can cause acoustic noise in certain applications. The acoustic noise comes from the electrostrictive effect of ferroelectric ceramics. If this is a concern, consider using low acoustic-noise capacitors on the output, such as the Murata GJ8 series capacitors or Rubycon polymer multilayer (PML) capacitors.

### Evaluating the MAX20053

The EV kit is capable of evaluating the MAX20053 with some minor modifications. The MAX20053 has a switching frequency of 2.1MHz. To accommodate the higher

switching frequency, L2 should be decreased to 4.7 $\mu$ H, R5 should be increased to 3.92k $\Omega$ , and C8 should be increased to 4700pF. The MAX20053 is only suitable for applications where the maximum input voltage is less than 40V.

### Evaluating the MAX20050 and MAX20052

The MAX20050 and MAX20052 offer internal error-amplifier compensation in a 12-pin TDFN-EP package. To evaluate these devices, order the MAX20050 EV kit instead.

## Component List

PART	QTY	DESCRIPTION
C1, C2, C4, C6, C7	5	2.2 $\mu$ F $\pm$ 10%, 100V X7R ceramic capacitors (1210)
C3	1	22 $\mu$ F, 100V electrolytic capacitor (Size F)
C5, C10	2	0.1 $\mu$ F $\pm$ 10%, 50V X7R ceramic capacitors (0603)
C8	1	0.01 $\mu$ F $\pm$ 10%, 16V X7R ceramic capacitor (0603)
C9	1	1 $\mu$ F $\pm$ 10%, 25V X7R ceramic capacitor (0603)
C11, C12, C16	0	Not installed, ceramic capacitors
C18	1	100pF $\pm$ 5%, 50V C0G ceramic capacitor (0603)
D2	1	80V, 1A Schottky diode (SMA) Diodes, Inc. B180A-13-F
D3	0	Not installed, Schottky diode
FB1	1	Inductor—PCB short

PART	QTY	DESCRIPTION
L1	1	4.7 $\mu$ H $\pm$ 20%, 6.2A inductor Coilcraft MSS1278T-472ML
L2	1	47 $\mu$ H $\pm$ 20%, 2.9A inductor Coilcraft MSS1278T-473ML
R1, R2	2	0.2 $\Omega$ $\pm$ 1% resistors (1206)
R3, R4	2	10 $\Omega$ $\pm$ 1% resistors (0603)
R5	1	2.74k $\Omega$ $\pm$ 1% resistor (0603)
R6, R13, R14	3	10k $\Omega$ $\pm$ 1% resistors (0603)
R7	1	10k $\Omega$ $\pm$ 10% potentiometer Bourns Inc. 3296W-1-103LF
R12	1	0 $\Omega$ $\pm$ 5% resistor (0603)
U1	1	LED driver (14 TSSOP-EP*) Maxim MAX20051AUD/V+
—	1	LED driver (14 TSSOP-EP*) Maxim MAX20053AUD/V+
—	1	PCB: MAX20051 EVKIT

\*EP = Exposed pad.

## Component Suppliers

SUPPLIER	PHONE	WEBSITE
Bourns Inc.	951-781-5500	www.bourns.com
Coilcraft Inc.	847-639-6400	www.coilcraft.com
Diodes Incorporated	805-446-4800	www.diodes.com
Murata Americas	770-436-1300	www.murataamericas.com

**Note:** Indicate that you are using the MAX20051 when contacting these component suppliers.

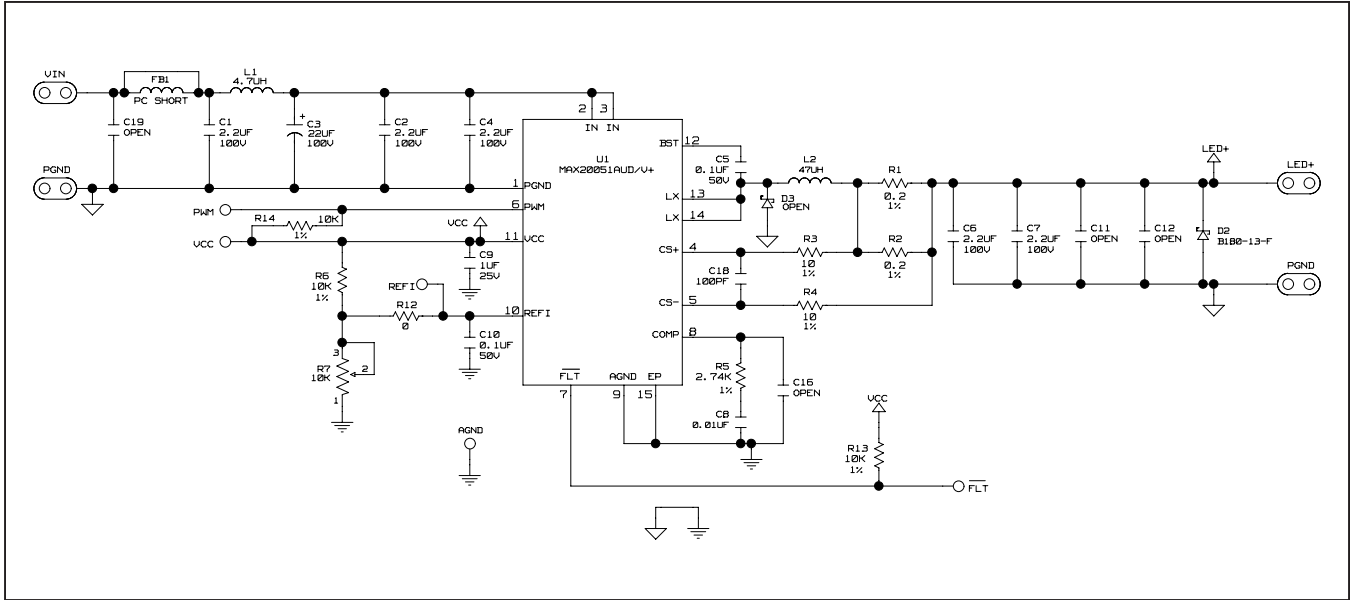

Figure 1. MAX20051 EV Kit Schematic

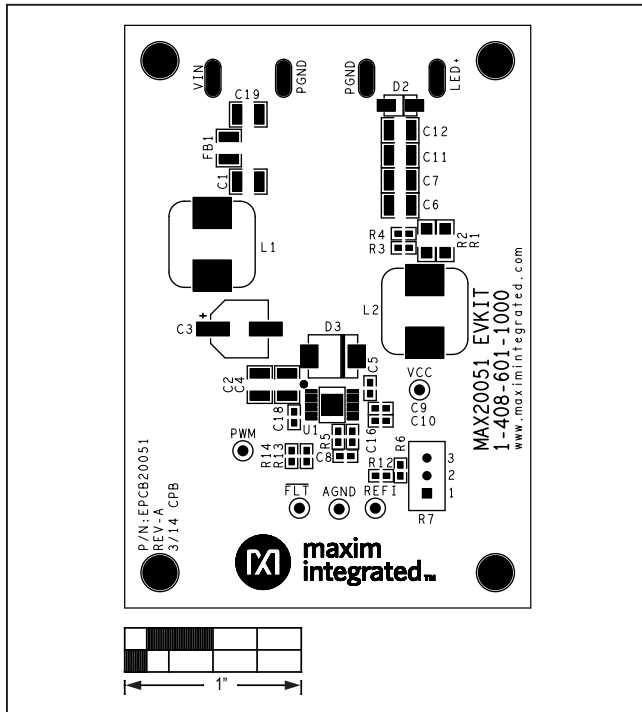

Figure 2. MAX20051 EV kit Component Placement Guide—Component Side

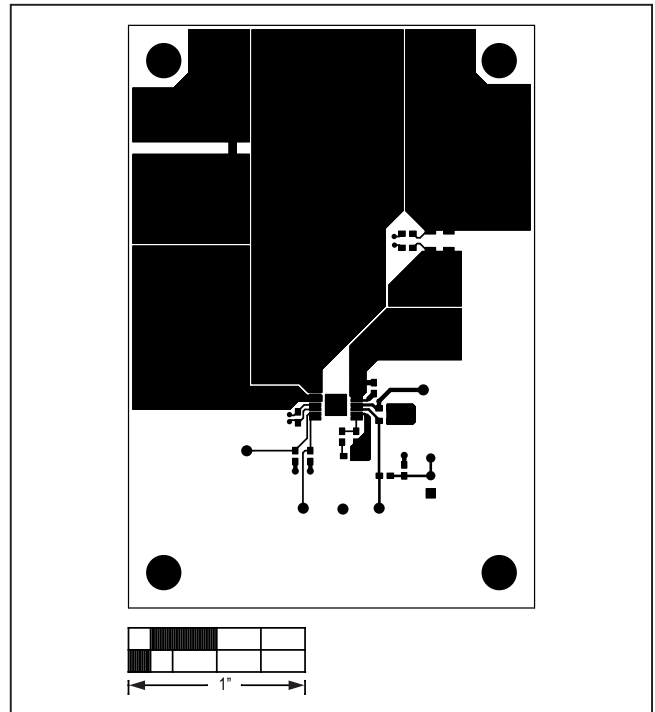

Figure 3. MAX20051 EV Kit PCB Layout—Component Side

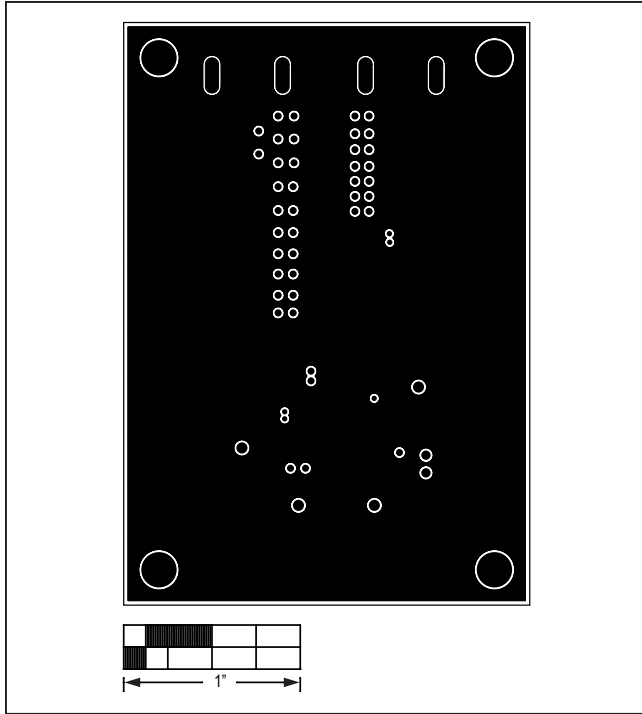

Figure 4. MAX20051 EV Kit PCB Layout—AGND Layer 2

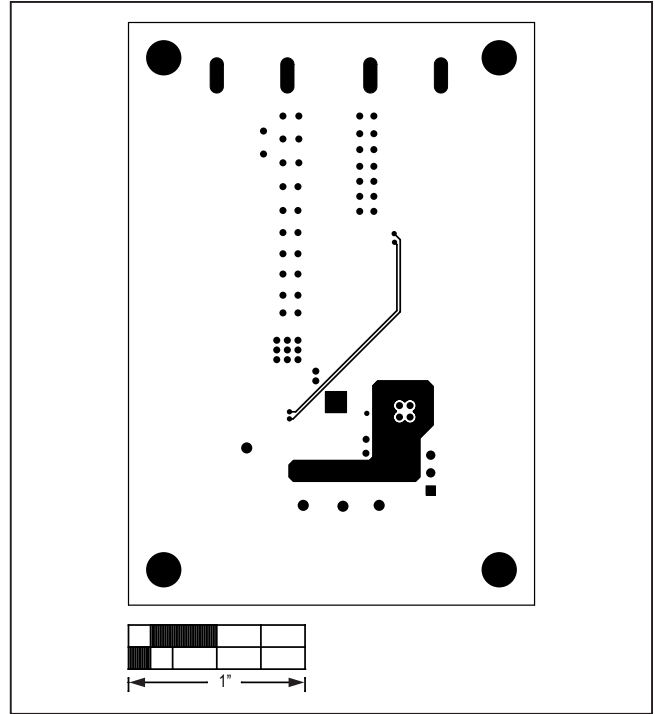

Figure 5. MAX20051 EV Kit PCB Layout—VCC Layer 3

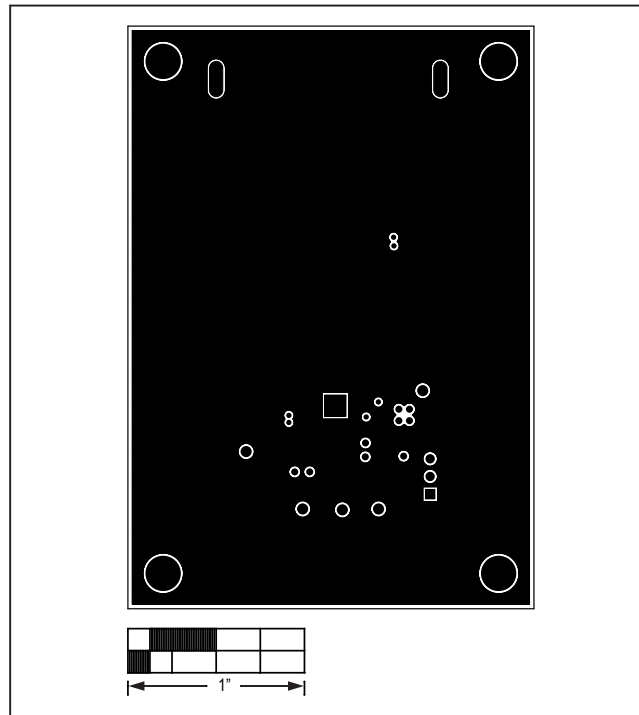

Figure 6. MAX20051 EV Kit PCB Layout—Solder Side

### Ordering Information

PART	TYPE
MAX20051EVKIT#	EV kit

*#Denotes RoHS compliant.*

## Revision History

REVISION NUMBER	REVISION DATE	DESCRIPTION	PAGES CHANGED
0	10/14	Initial release	—

For information on other Maxim Integrated products, visit Maxim Integrated's website at [www.maximintegrated.com](http://www.maximintegrated.com).

*Maxim Integrated cannot assume responsibility for use of any circuitry other than circuitry entirely embodied in a Maxim Integrated product. No circuit patent licenses are implied. Maxim Integrated reserves the right to change the circuitry and specifications without notice at any time.*