

Steward

Advanced Ferrite Materials, EMI Suppression, and Inductive Products

Ferrite Product Lines • New Products • Technical • General • Contact • Steward Sales

DM1612X560R-00

STEWARD PART NUMBERING SYSTEM					
28	F	0121	- 0	S	R
MATERIAL TYPE	PRODUCT CODE	PART SIZE CODE	SELECTED DIMENSION CODE	ADDITIONAL DESCRIPTION	PACKAGING CODE

Ambient Operating Temperature Range : -55°C to +125°C

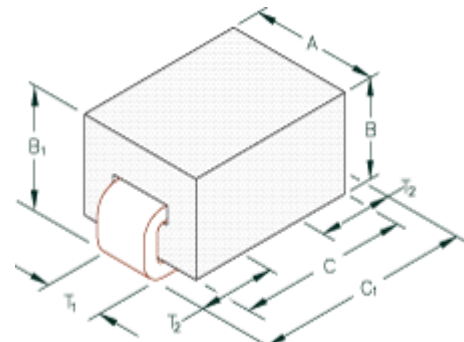

Figure #1

STEWARD PART NUMBERING SYSTEM					
DM	3312	X	101	R	(10 Pb Free) - 00
PRODUCT SERIES CODE	PART SIZE CODE	RATED CURRENT CODE	IMPEDANCE VALUE CODE	PACKAGING CODE	ADDITIONAL DESCRIPTION

Ambient Operating Temperature Range : -55°C to +125°C

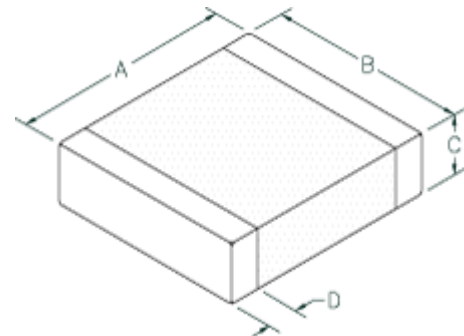

Figure #2

Drawing Figure

Fig #
2

Electrical Characteristics

NET Z @ 100MHz	DCR Max	Rated Current mA
46	0.004	10000

Physical Dimensions

A mm	B mm	B1 mm	C mm	C1 mm	A in	B in	B1 in	C in	C1 in
4.06	3.05	0	2.28	0	0.160	0.120	0	0.090	0

Wire Dimensions

T1 mm	T2 mm	T1 in	T2 in
0	0	0	0

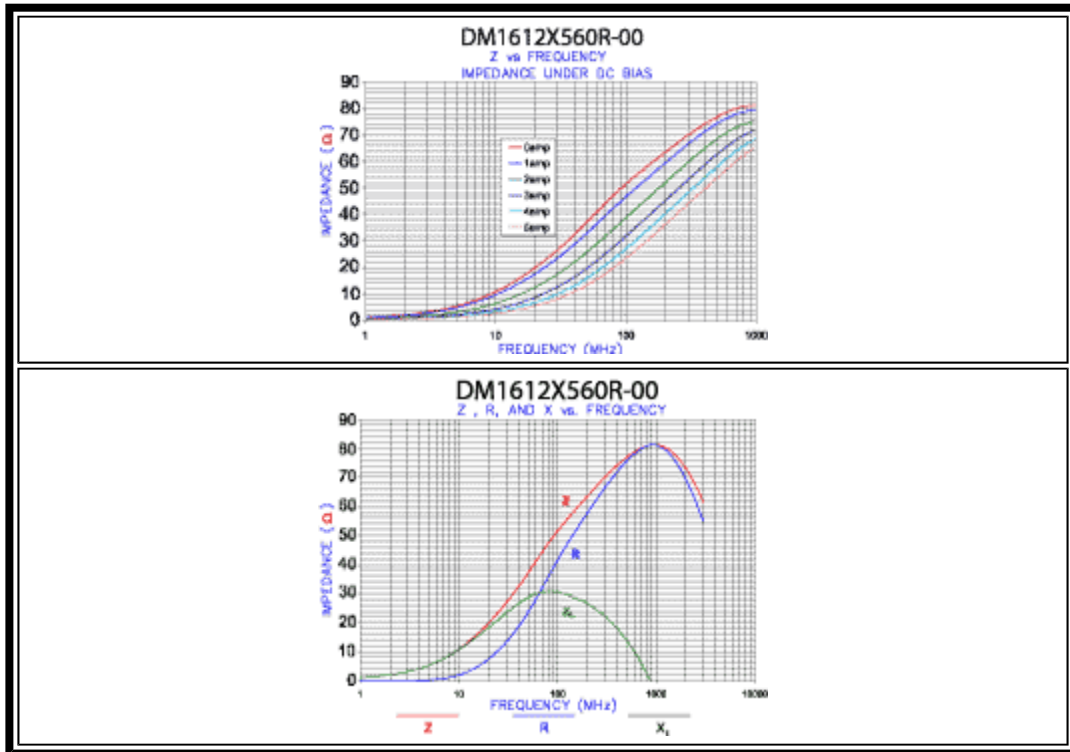

americas@steward.com mexico@steward.com europe@steward.com asia@steward.com

Copyright© 2003 Steward, Inc.

Last Updated: 5/15/2003