

CBM-120

Mosaic Array Series

Ultraviolet Chip On Board LEDs

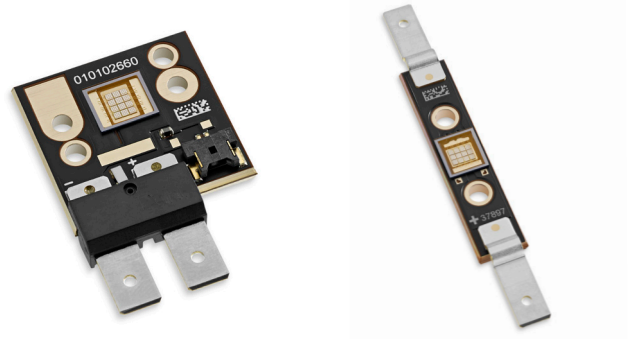

Table of Contents

- Technology Overview2
- Ordering Information3
- Binning Structure4
- Ordering Bin Kits5
- Optical & Electrical Characteristics6
- Typical Spectrum8
- Angular Distribution8
- Reliability Data9
- Thermal Resistance 10
- Electrical Pinout (C31) 10
- Mechanical Dimensions Square Package (C31) 11
- Mechanical Dimensions Slim Package (C14) 12
- Shipping Tray Square Package (C31) 13
- Shipping Tray Slim Package (C14) 14
- Packaging Specifications . 15
- Revision History 16

Features:

- Mosaic Array UV LED chipset with surface emitting area of 12 mm², 4:3 aspect ratio
- All the benefits of chip on board processing without the need for complicated assembly process
- Vertical chip UV LED technology for high power density and uniform emission
- Wide Range of UVA Wavelengths
- High thermal conductivity copper coreboard package
- Low-profile window for efficient coupling into small-extendue systems
- Can be operated at variable drive currents up to 18A
- NIST traceable optical and electrical measurement testing
- Environmentally friendly: RoHS and Halogen compliant

Applications:

- Curing:
 - › Inks
 - › Coatings
 - › Adhesives
- Inspection
- Machine Vision
- Fiber-coupled illumination
- Specialty Projection Systems for Maskless Lithography
- Rapid Prototyping and 3D printing
- Medical and Scientific Instrumentation

Technology Overview

Luminus LEDs benefit from innovations in device technology, chip packaging and thermal management. This suite of technologies give engineers and system designers the freedom to develop solutions both high in power and efficiency.

Luminus Mosaic Array LED Technology

Luminus' Devices vertical chip technology enables LED chips with uniform brightness over the entire chip surface. The optical power and brightness produced by these densely packed arrays of devices enable solutions not possible with single chip packages that be used to replace arc and halogen lamps.

Packaging Technology

Thermal management is critical in high power LED applications. With a thermal resistance from junction to heat sink of 0.6 °C/W, Luminus CBM-120 LEDs have the lowest thermal resistance of any UV LED on the market. This will allow the LEDs to be driven at higher current densities while maintaining a low junction temperature, thereby resulting in brighter solutions and longer lifetimes.

Reliability

With designs based on years of chip and packaging development experience, Luminus LEDs are one of the most reliable light sources in the world today. Luminus LEDs pass a rigorous suite of environmental and mechanical stress tests, including mechanical shock, vibration, temperature cycling and humidity, and have been fully qualified for use in extreme high power and high current applications. With very low failure rates and median lifetimes that can exceed 30,000 hours, Luminus UV LEDs are ready for even the most demanding applications.

Environmental Benefits

Luminus LEDs help reduce power consumption and the amount of hazardous waste entering the environment. All LED products manufactured by Luminus are RoHS and Halogen compliant and free of hazardous materials, including lead and mercury.

Understanding Mosaic Array UV LED Test Specifications

Every Luminus LED is fully tested to ensure that it meets the high quality standards expected from Luminus' products.

Testing Temperature

Luminus core board products are typically measured in such a way that the characteristics reported agree with how the devices will actually perform when incorporated into a system. This measurement is accomplished by mounting the devices on a 40°C heat sink and measuring the device while fully powered. This method of measurement ensures that Luminus LEDs perform in the field just as they are specified.

Multiple Operating Points

The tables on the following pages provide typical optical and electrical characteristics for the standard drive conditions. Since the LEDs can be operated over a wide range of drive conditions (currents from 200 mA to 18 A, and duty cycle from <1% to 100%) there are many other potential values attainable. Driving devices beyond recommended driving conditions shortens lifetime.

Ordering Information

Products	Ordering Part Number	Description
CBM-120-UV	CBM-120-UV-C31-FF###-2#	CBM-120 Mosaic Array UV chipset consisting of 12x1 mm ² UV LEDs, a thermistor, connectors, and a square copper-core PCB.
	CBM-120-UV-C14-FF###-2#	CBM-120 Mosaic Array UV chipset consisting of 12x1 mm ² UV LEDs, connectors, and a slim (rectangular) copper-core PCB.

Part Number Nomenclature

CBM — 120 — CC — C## — FF###-2#

Product Family	Chip Area	Color	Package Configuration	Bin Kit ^{1,2}
CBM: Copper-core PCB, Mosaic Array	120: 12 mm ²	UV = Ultraviolet	C14: 44.5 mm x 10 mm - Slim Package C31: 28 mm x 26.75 mm - Square Package See Mechanical Drawing section	See page 5 for complete bin definition table

Note 1: A Bin Kit represents a group of individual flux or power bins that are shippable for a given ordering part number. Individual flux bins are not orderable.

Note 2: Flux Bin listed is minimum bin shipped - higher bins may be included at Luminus' discretion

CBM-120-UV Binning Structure

CBM-120-UV LEDs are specified for luminous flux and chromaticity/wavelength at a drive current of 9 A (750 mA/mm²) and placed into one of the following Power Bins and Wavelength Bins:

Power Bins³

Color	Power Flux Bin (FF)	Minimum Flux (W)	Maximum Flux (W)
UV	FA	6.0	6.5
	FB	6.5	7.0
	GA	7.0	7.5
	GB	7.5	8.0
	H	8.0	9.1
	I	9.1	10.0
	J	10.0	11.0
	K	11.0	12.1
	L	12.1	13.3

Note 3: Luminus maintains a +/- 6% tolerance on power measurements.

Peak Wavelength Bins

Color	Wavelength Bin (###)	Minimum Wavelength (nm)	Maximum Wavelength (nm)
UV	365	365	370
	370	370	375
	375	375	380
	380	380	385
	385	385	390
	390	390	395
	395	395	400
	400	400	405
	405	405	410

CBM-120 UV Mosaic Array Bin Kits

Wavelength Range	Luminous Flux		Wavelength Bins	Ordering Bin Kit Number
	Bin Kit Flux Code	Min. Flux		
365-375	FA	6.0	365	FA365-21
			365, 370	FA365-22
	FB	6.5	365	FB365-21
			365, 370	FB365-22
	GB	7.7	365	GB365-21
			365, 370	GB365-22
	H	8.0	365	H365-21
			365, 370	H365-22
380-390	K	11.0	380	K380-21
			385	K385-21
			380, 385	K380-22
	L	12.1	380	L380-21
			385	L385-21
			380, 385	L380-22
390-400	K	11.0	390	K390-21
			395	K395-21
			390, 395	K390-22
	L	12.1	390	L390-21
			395	L395-21
			390, 395	L390-22
400-410	K	11.0	400	K400-21
			405	K405-21
			400, 405	K400-22
	L	12.1	400	L400-21
			405	L405-21
			400, 405	L400-22

Reference Optical & Electrical Characteristics ($T_{hs} = 40^{\circ}\text{C}$)^{4,5}

UV						
Parameter	Symbol	Values ⁶				Unit
Peak Wavelength Range	λ	365 - 375	380-390	390-400	400-410	nm
Drive Conditions ⁷	I	9.0	9.0	9.0	9.0	A
Peak Wavelength Typ.	λ_p	368	384 387	393 397	403 407	nm
Current Density	j	0.75	0.75	0.75	0.75	A/mm ²
Forward Voltage	V_{Fmin}	3.0	3.0	3.0	3.0	V
	V_F	3.6	3.6	3.6	3.6	V
	V_{Fmax}	4.0	4.0	4.0	4.0	V
Radiometric Flux ⁸	Φ_{typ}	8.5	11.5	11.5	11.5	W
FWHM at 50% of Φ	$\Delta\lambda_{1/2}$	14	14	14	14	nm

Parameter	Symbol	Values	Unit
Absolute Minimum Current (CW or Pulsed) ⁹		0.2	A
Absolute Maximum Current (CW) ¹⁰		365nm - 12 380nm-410nm - 18	A
Absolute Maximum Surge Current ¹⁰ (Frequency > 240 Hz, duty cycle =10%, t=1ms)		30	A
Maximum Junction Temperature ¹¹	T_{jmax}	100	°C
Storage Temperature Range		-40 to +100	°C
Emitting Area		12.9	mm ²
Emitting Area Dimensions		4.50 × 3.32	mm × mm

Note 4: Data verified using NIST traceable calibration standard.

Note 5: All data are based on test conditions with a constant heat sink temperature $T_{hs} = 40^{\circ}\text{C}$ under pulse testing conditions. Pulse conditions: 25% duty-cycle, frequency of 720Hz, 3 second soak.

Note 6: Unless otherwise noted, values listed are typical. Devices are production tested and specified at 9 A.

Note 7: Listed drive conditions are typical for common applications. CBM120-UV devices can be driven at currents ranging from 200 mA to 12A-18 A and at duty cycles ranging from 1% to 100%. Drive current and duty cycle should be adjusted as necessary to maintain the junction temperature desired to meet application lifetime requirements.

Note 8: Typical total flux from emitting area at listed peak wavelength. Reported performance is included to show trends for a selected power level. For specific minimum and maximum values, use bin tables. For product roadmap and future performance of devices, contact Luminus.

Note 9: Special design considerations must be observed for operation under 1 A. Please contact Luminus for further information.

Note 10: CBM-120-UV LEDs are designed for operation to an absolute maximum current as specified above. Product lifetime data is specified at recommended forward drive currents. Sustained operation at or beyond absolute maximum currents will result in a reduction of device life time compared to recommended forward drive currents. Actual device lifetimes will also depend on junction temperature. Refer to the lifetime derating curves for further information. In pulsed operation, rise time from 10-90% of forward current should be longer than 0.5 $\mu\text{seconds}$.

Note 11: Lifetime dependent on LED junction temperature. Input power and thermal system must be properly managed to ensure lifetime.

Optical & Electrical Characteristics

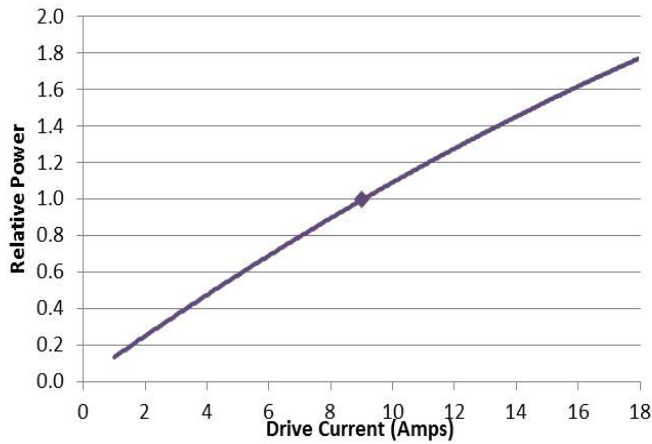
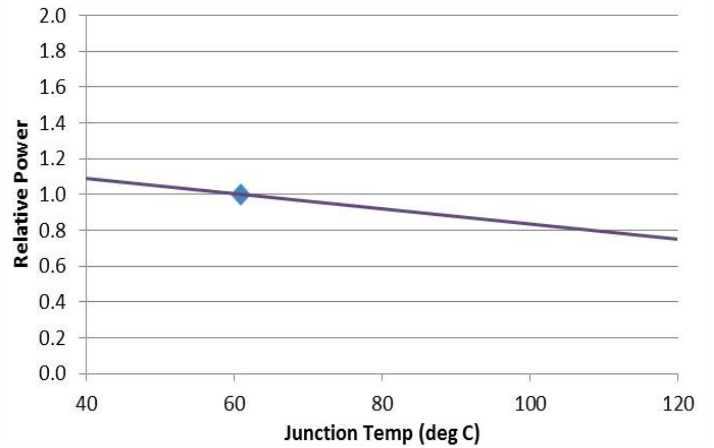
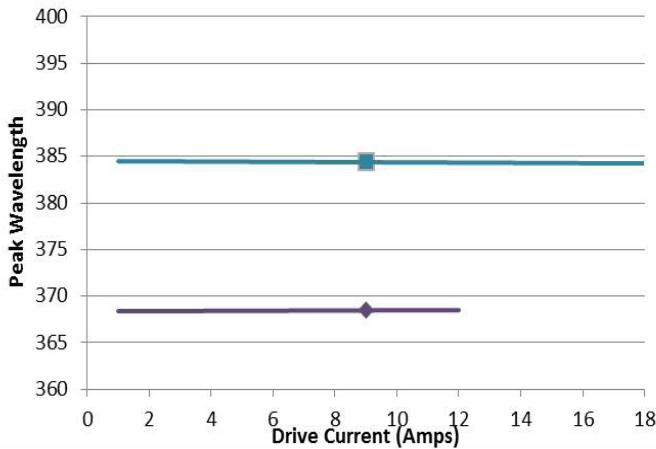
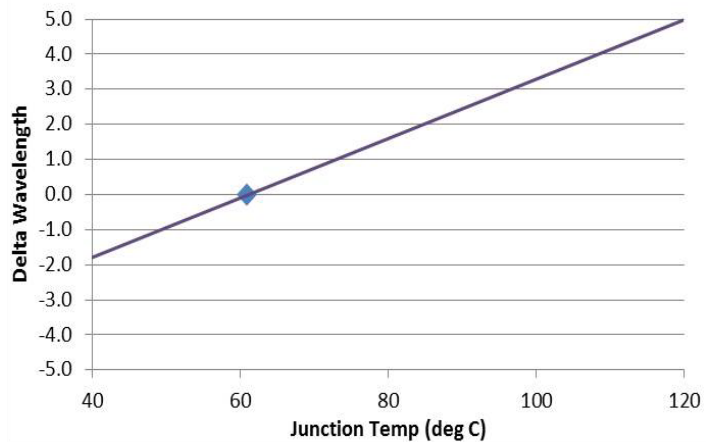
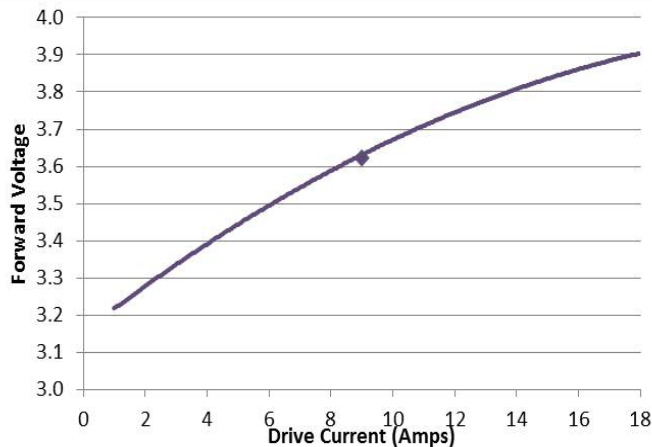
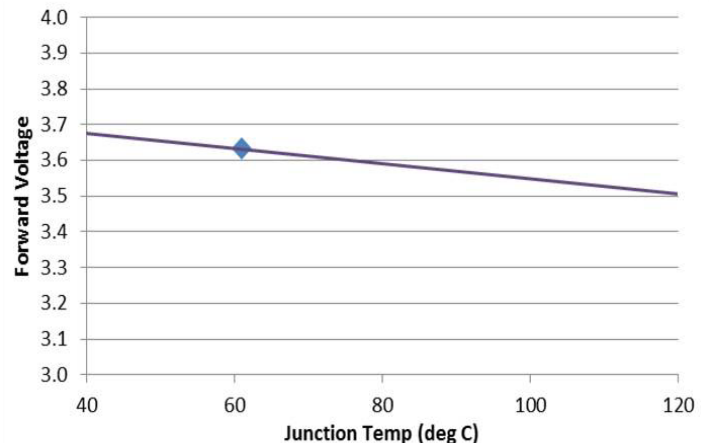
Relative Power vs Forward Current, $T_j = 60^\circ\text{C}$

Relative Power vs Junc. Temperature, $I_f = 9\text{ A}$

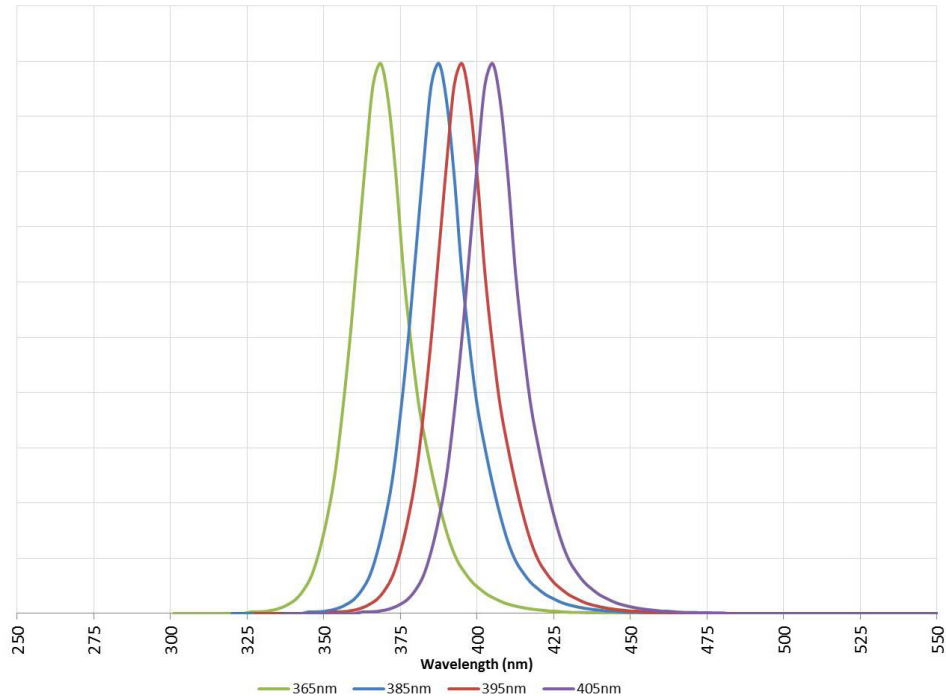
Peak Wavelength vs Forward Current

Peak Wavelength vs Junction Temperature

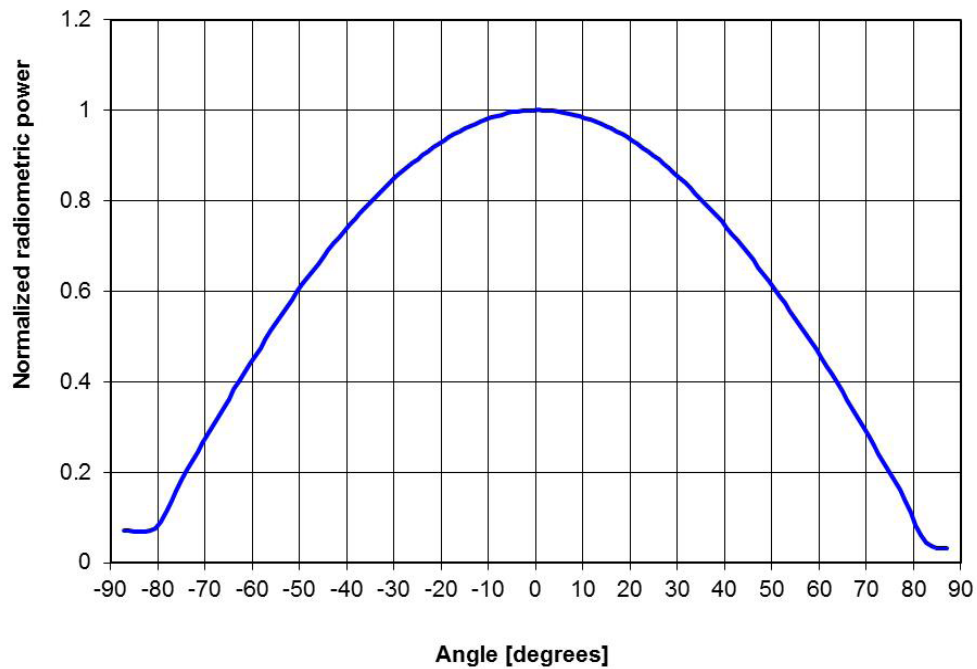
Forward Voltage vs Forward Current

Forward Voltage vs Junction Temperature

Typical Spectrum ¹²



Emission Angle ¹³



Note 12: Typical spectrum at current of 9 A in continuous operation.

Note 13: Detailed information on emission including ray trace files can be found at: <http://www.luminus.com/resource/design.html>

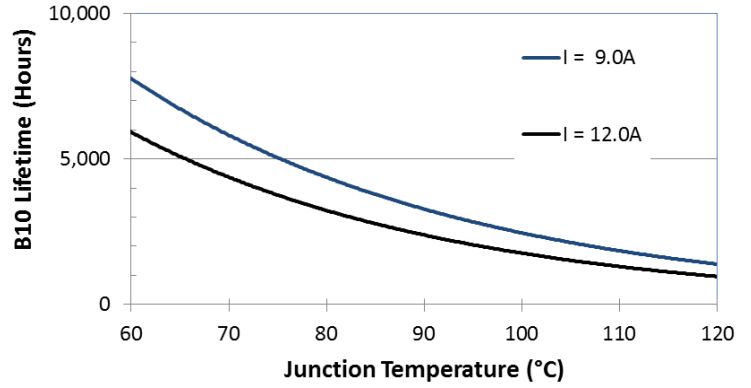
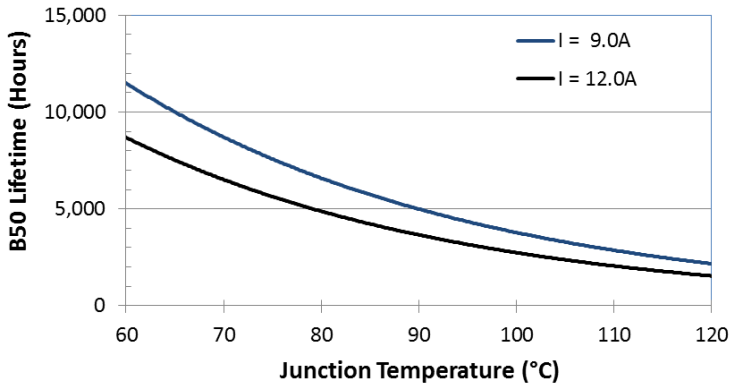
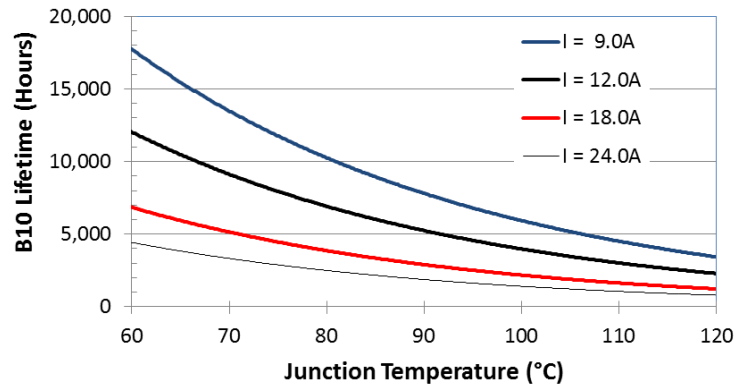
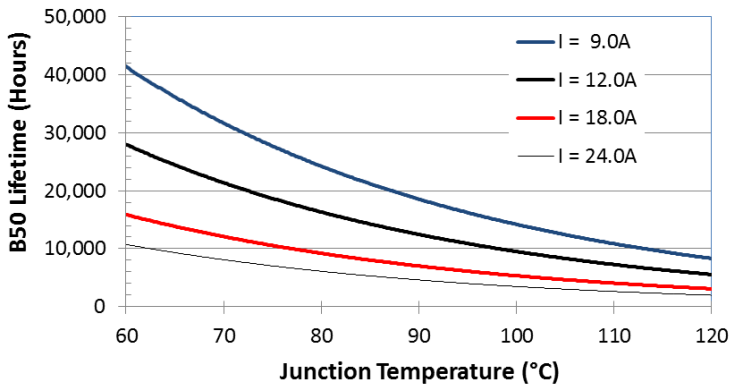
Reliability Data - 365nm

Reliability Data - 380nm-410nm

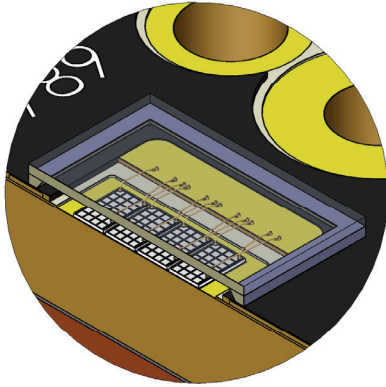
Thermal Resistance CBM-120-UV

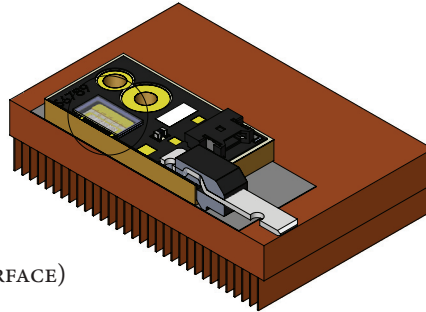

T_J = DIE JUNCTION TEMP
 T_B = COREBOARD TEMP
 T_{HS} = HEATSINK TEMP (3MM FROM SURFACE)
 T_{REF} - THERMISTOR TEMP



Typical Thermal Resistance¹⁴ - C31

R _{θj-b} ¹⁵	0.61 °C/W
R _{θb-hs} ¹⁶	0.12 °C/W
R _{θj-hs} ¹⁶	0.73 °C/W
R _{θj-ref} ¹⁵	0.64 °C/W

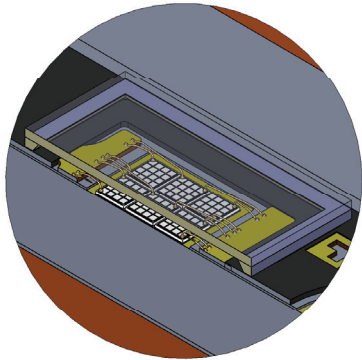

T_J = DIE JUNCTION TEMP
 T_B = COREBOARD TEMP
 T_{HS} = HEATSINK TEMP (3MM FROM SURFACE)

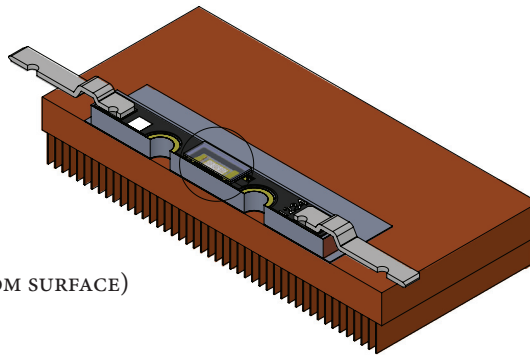

Typical Thermal Resistance¹⁴ - C14

R _{θj-b} ¹⁵	0.76 °C/W
R _{θb-hs} ¹⁶	0.12 °C/W
R _{θj-hs} ¹⁶	0.88 °C/W

Note 14: Real thermal resistance data - "Electrical" thermal resistance values available upon request

Note 15: Thermal resistance values are based on measured wavelength shift data.

Note 16: Thermal Resistance is based on eGraf 1205 Thermal interface.

Electrical Pinout - C31 Package

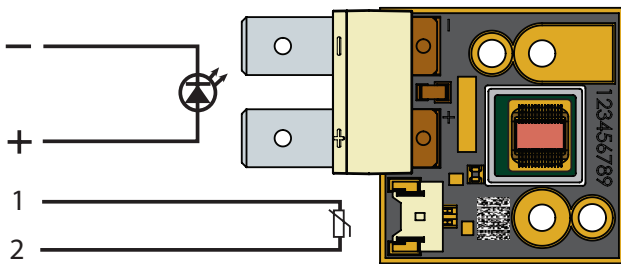

The thermistor used in CBT-120 devices mounted on coreboards is from Murata Manufacturing Co. The global part number is NCP18XH103J03RB. Please see <http://www.murata.com/> for details on calculating thermistor temperature.

For more information on use of the thermistor, please contact Luminus directly.

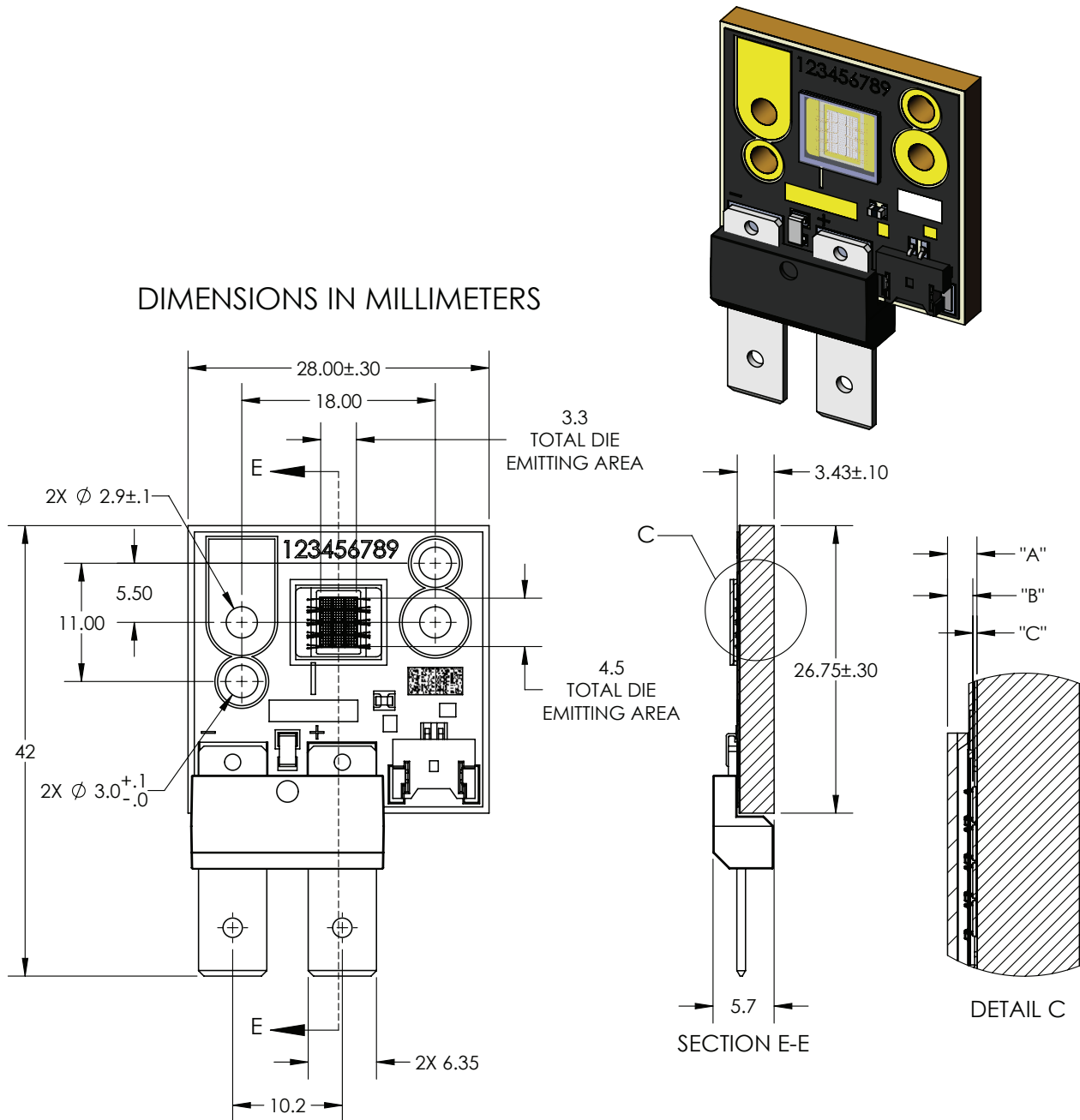
Mechanical Dimensions – CBM-120-UV-C31 Mosaic Array LED Emitter

DIMENSION NAME	DESCRIPTION	NOMINAL DIMENSION	TOLERANCE
"A"	TOP OF METAL SUBSTRATE TO TOP OF WINDOW	.91	±.13
"B"	TOP OF DIE EMITTING AREA TO TOP OF WINDOW	.78	±.11
"C"	TOP OF METAL SUBSTRATE TO TOP OF DIE EMITTING AREA	.13	±.02

Recommended connector for Anode and Cathode: Panduit Disco Lok™ Series P/N: DNG14-250FL-C.
 Thermistor Connector: MOLEX P/N 53780-0270 or GCT P/N WTB08-021S-F.
 Recommended Female: MOLEX P/N 51146-0200, GCT P/N WTB06-021S-F or equivalent

DWG-002558

Mechanical Dimensions – CBM-120-UV-C14 Mosaic Array LED Emitter

DIMENSIONS IN MILLIMETERS

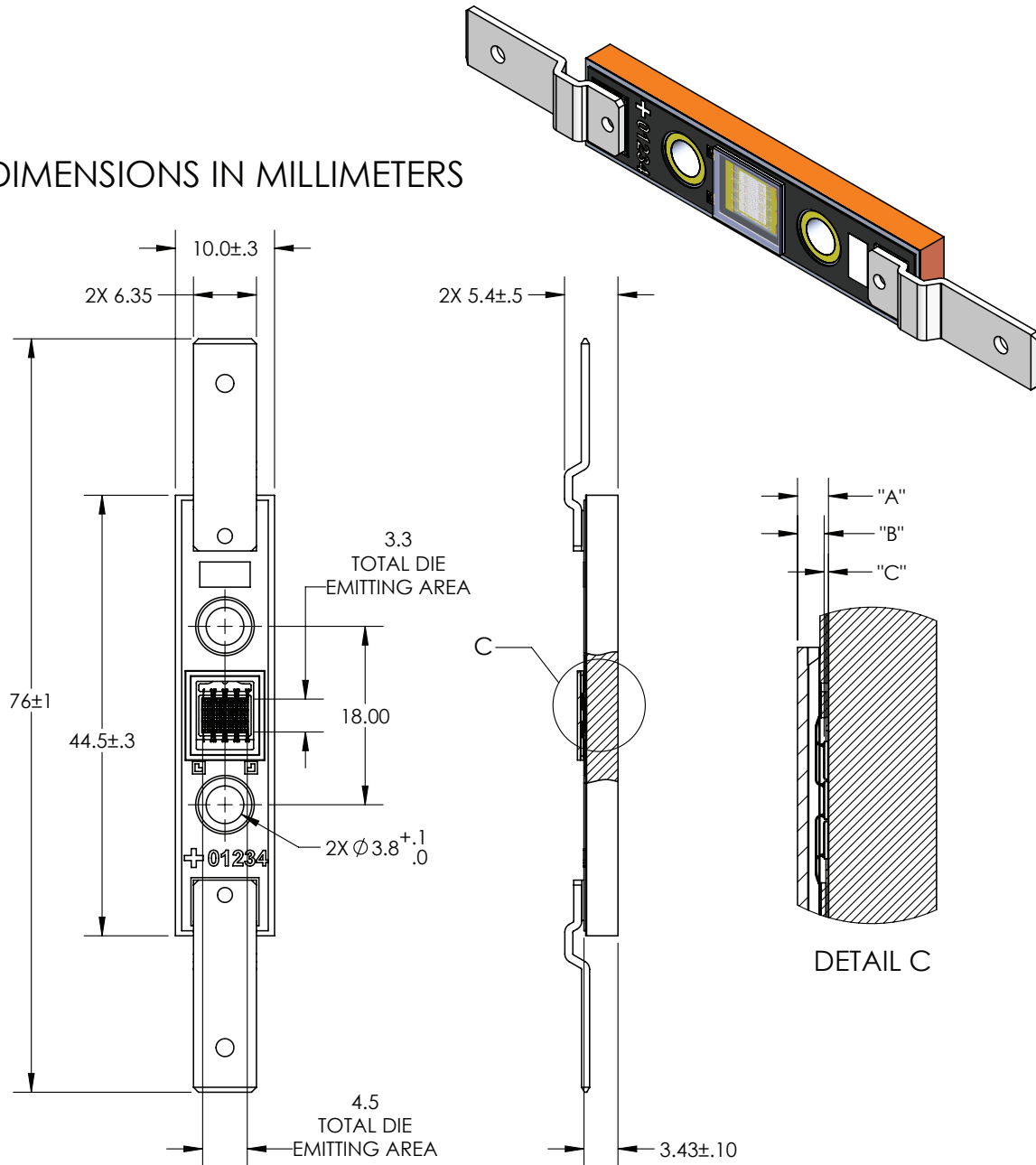

DIMENSION NAME	DESCRIPTION	NOMINAL DIMENSION	TOLERANCE
"A"	TOP OF METAL SUBSTRATE TO TOP OF WINDOW	.91	±.13
"B"	TOP OF DIE EMITTING AREA TO TOP OF WINDOW	.78	±.11
"C"	TOP OF METAL SUBSTRATE TO TOP OF DIE EMITTING AREA	.13	±.02

DWG-002534

Recommended connector for Anode and Cathode: Panduit Disco Lok™ Series P/N: DNG14-250FL-C.

Shipping Tray Outline - CBM-120-C31

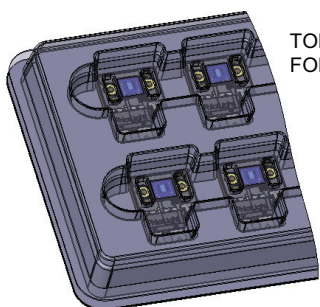
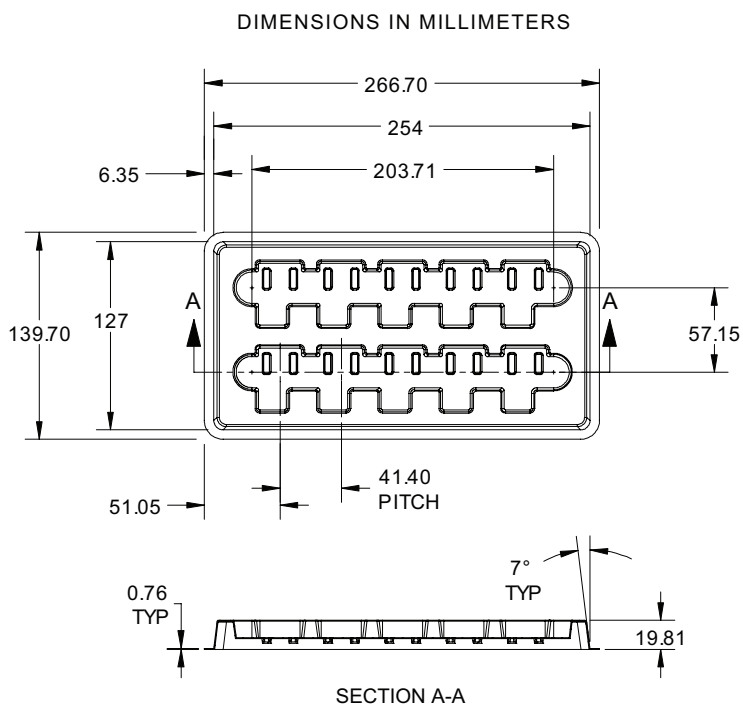

TOP TRAY SHOWN TRANSPARENT FOR REFERENCE ONLY

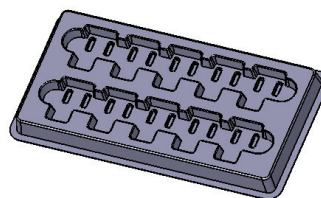

Shipping Tray Outline - CBM-120-C14

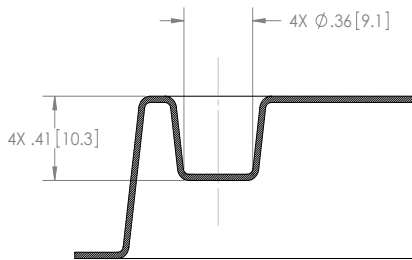
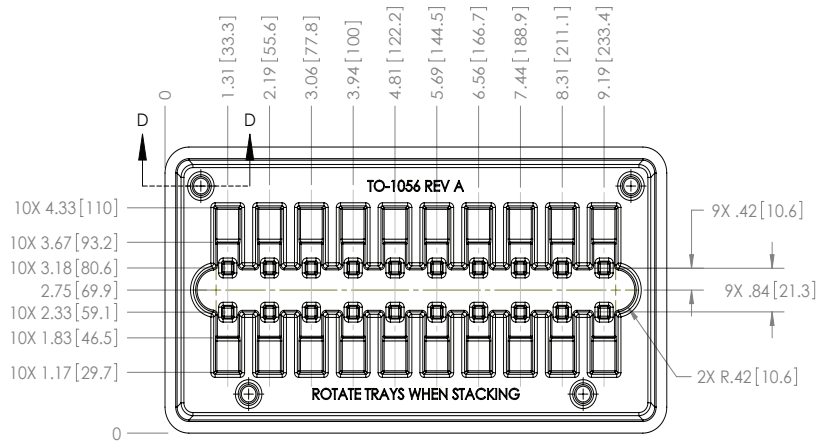

SECTION D-D
SCALE 2:1

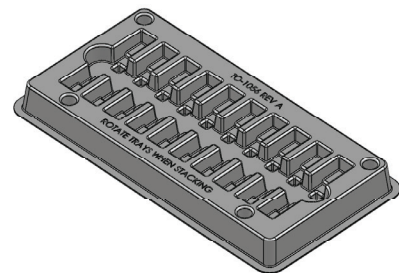

Packing and Shipping Specification (CBM-120)

Packing Specification

Packing Configuration	Qty /Pack	Box Dimensions (diameter x W, mm)	Gross Weight (kg)
Stack of 5 trays with 10 devices per tray Each pack is enclosed in ESD bag	50	140 x 280 x 70	2.7







Product Label Specification

Label Fields (subject to change):

- 6-8 digit Box number (for Luminus internal use)
- Luminus ordering part number
- Quantity of devices in pack
- Part number revision (for Luminus internal use)
- Customer's part number (optional)
- Flux Bin
- 2D Bar code



LUMINUS
LEADER IN BIG CHIP LEDS Solid State Filament™

BT-012345  Box number	Qty: 50 	
PT-120-G-L11-MPG  Luminus part number	Rev 01 	for traceability peel off label and attach
12345678  Customer part number		
5F  Bin		

RoHS Compliant

Sample label –for illustration only

Shipping Box

Shipping Box	Quantity	Material	Dimensions (L x W x H, mm)
Carton Box	1 -20 packs (50 - 1000 Devices)	S4651	560 x 560 x 200



History of Changes

Rev	Date	Description of Change
A	01/09/2015	Initial Release - Preliminary Specifications for 365nm and 380nm CBM-120 Parts
B	03/20/2015	Added Data for 390nm and 400nm CBM-120 Parts, Updated binning structure
01	05/31/2015	Updated Binning, Added Angular Distribution Data, Added Reliability Data
02	09/18/2015	Updated Binning
03	03/29/2016	Updated Binning

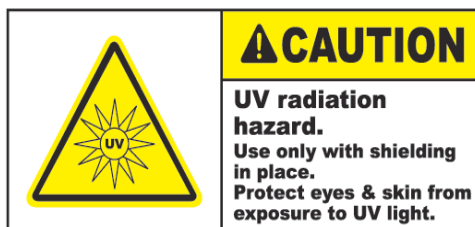

The products, their specifications and other information appearing in this document are subject to change by Luminus Devices without notice. Luminus Devices assumes no liability for errors that may appear in this document, and no liability otherwise arising from the application or use of the product or information contained herein. None of the information provided herein should be considered to be a representation of the fitness or suitability of the product for any particular application or as any other form of warranty. Luminus Devices' product warranties are limited to only such warranties as accompany a purchase contract or purchase order for such products. Nothing herein is to be construed as constituting an additional warranty. No information contained in this publication may be considered as a waiver by Luminus Devices of any intellectual property rights that Luminus Devices may have in such information. Big Chip LEDs™ is a registered trademark of Luminus Devices, Inc., all rights reserved.

This product is protected by U.S. Patents 6,831,302; 7,074,631; 7,083,993; 7,084,434; 7,098,589; 7,105,861; 7,138,666; 7,166,870; 7,166,871; 7,170,100; 7,196,354; 7,211,831; 7,262,550; 7,274,043; 7,301,271; 7,341,880; 7,344,903; 7,345,416; 7,348,603; 7,388,233; 7,391,059 Patents Pending in the U.S. and other countries.