



# BGU8061

low-noise high-linearity amplifier

Rev. 2.1 — 23 March 2022

Product data sheet

## 1 General description

---

The BGU8061 is, also known as the BTS3001L, a high-linearity bypass amplifier for wireless infrastructure applications, equipped with fast shutdown to support TDD systems. The LNA has a high input and output return loss and is designed to operate between 0.7 GHz and 1.5 GHz. It is housed in a 3 mm × 3 mm × 0.85 mm 10-terminal plastic thin small outline package. The LNA is ESD protected on all terminals.

## 2 Features and benefits

---

- Low-noise performance: NF = 1.1 dB
- High-linearity performance: IP<sub>3O</sub> = 36.5 dBm
- High-input return loss > 10 dB
- High-output return loss > 10 dB
- Unconditionally stable up to 20 GHz
- Small 10-terminal leadless package 3 mm × 3 mm × 0.85 mm
- ESD protection on all terminals
- Moisture sensitivity level 1
- Fast shut down to support TDD systems
- +5 V single supply

## 3 Applications

---

- Wireless infrastructure
- Low noise and high-linearity applications
- LTE, W-CDMA, CDMA, GSM
- General-purpose wireless applications
- TDD or FDD systems
- Suitable for small cells



## 4 Quick reference data

Table 1. Quick reference data

$f = 900\text{ MHz}$ ;  $V_{CC} = 5\text{ V}$ ;  $T_{amb} = 25\text{ °C}$ ; input and output  $50\ \Omega$ ; unless otherwise specified. All RF parameters are measured on an application board with the circuit as shown in Figure 29 and components listed in Table 9 implemented. This board is optimized for  $f = 900\text{ MHz}$ .

Symbol	Parameter	Conditions	Min	Typ	Max	Unit
$I_{CC}$	supply current	LNA enable; bypass off	-	70	85	mA
		LNA disable; bypass on	-	3	5	mA
$G_{ass}$	associated gain	LNA enable; bypass off	19	20.5	22	dB
		LNA disable; bypass on	-1.6	-1.0	-	dB
NF	noise figure	LNA enable; bypass off <sup>[1]</sup>	-	1.1	1.8	dB
$P_{L(1dB)}$	output power at 1 dB gain compression	LNA enable; bypass off	19	20.5	-	dBm
$IP3O$	output third-order intercept point	2-tone; tone spacing = 1 MHz; PL = 5 dBm per tone				
		LNA enable; bypass off	33.5	36.5	-	dBm
		LNA disable; bypass on	-	44	-	dBm

[1] Connector and Printed-Circuit Board (PCB) losses have been de-embedded.

## 5 Ordering information

Table 2. Ordering information

Type number	Package		Version
	Name	Description	
BGU8061	HVSON10	plastic thermal enhanced very thin small outline package; no leads; 10 terminals; body 3 mm × 3 mm × 0.85 mm	SOT650-2

## 6 Block diagram

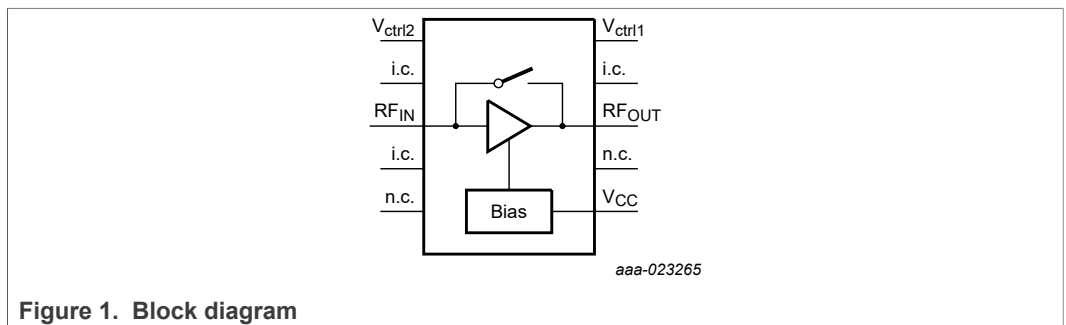

## 7 Pinning information

### 7.1 Pinning

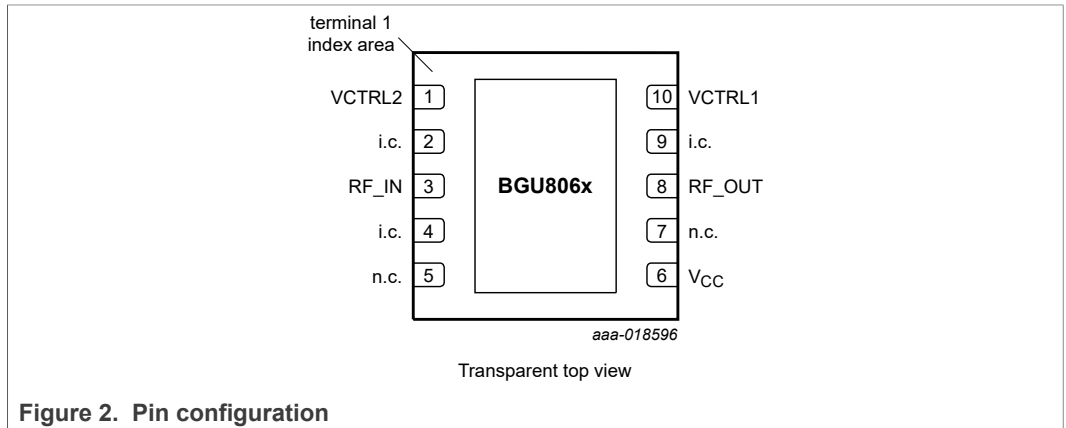

Figure 2. Pin configuration

### 7.2 Pin description

Table 3. Pin description

Symbol	Pin	Description
VCTRL2	1	voltage control 2
i.c.	2, 4, 9	internally connected, can be grounded or left open in the application
RF_IN	3	RF input
n.c.	5	not connected
V <sub>CC</sub>	6	supply voltage
n.c.	7	not connected
RF_OUT	8	RF output
VCTRL1	10	voltage control 1
GND	exposed die pad	ground

## 8 Limiting values

**Table 4. Limiting values**

In accordance with the Absolute Maximum Rating System (IEC 60134).

Symbol	Parameter	Conditions	Min	Max	Unit
V <sub>CC</sub>	supply voltage		-	6	V
V <sub>i(CTRL1)</sub>	input voltage on pin CTRL1		-	3.6	V
V <sub>i(CTRL2)</sub>	input voltage on pin CTRL2		-	3.6	V
P <sub>i(RF)CW</sub>	continuous waveform RF input power		-	20	dBm
T <sub>amb</sub>	ambient temperature		-40	85	°C
T <sub>stg</sub>	storage temperature		-40	150	°C
T <sub>j</sub>	junction temperature		-	150	°C
P	power dissipation	T <sub>case</sub> ≤ 125 °C [1]	-	510	mW
V <sub>ESD</sub>	electrostatic discharge voltage	Human Body Model (HBM) according to ANSI/ESDA/JEDEC standard JS-001-2010	-	2	kV
		Charged Device Model (CDM) according to JEDEC standard 22-C101B	-	1	kV

[1] Case is ground solder pad

## 9 Recommended operating conditions

**Table 5. Characteristics**

Symbol	Parameter	Conditions	Min	Typ	Max	Unit
V <sub>CC</sub>	supply voltage		4.75	5	5.25	V
Z <sub>0</sub>	characteristic impedance		-	50	-	Ω

## 10 Thermal characteristics

**Table 6. Thermal characteristics**

Symbol	Parameter	Conditions	Min	Typ	Max	Unit
R <sub>th(j-case)</sub>	thermal resistance from junction to case	[1] [2]	-	55	-	K/W

[1] Case is ground solder pad

[2] Thermal resistance measured using infrared measurement technique, device mounted on application board and placed in still air

## 11 Characteristics

**Table 7. Characteristics**

$f = 900$  MHz;  $V_{CC} = 5$  V;  $T_{amb} = 25$  °C; input and output 50  $\Omega$ ; unless otherwise specified. All RF parameters are measured on an application board with the circuit as shown in [Figure 29](#) and components listed in [Table 9](#) implemented. This board is optimized for  $f = 900$  MHz.

Symbol	Parameter	Conditions	Min	Typ	Max	Unit
$I_{CC}$	supply current	LNA enable; bypass off	-	70	85	mA
		LNA disable; bypass on	-	3	5	mA
$G_{ass}$	associated gain	LNA enable; bypass off	19	20.5	22	dB
		LNA disable; bypass on	-1.6	-1.0	-	dB
$G_{flat}$	gain flatness	within 100 MHz bandwidth; LNA enable; bypass off				
		$700 \text{ MHz} \leq f \leq 1500 \text{ MHz}$	-	0.9	-	dB
		$1000 \text{ MHz} \leq f \leq 1500 \text{ MHz}$	-	0.8	-	dB
NF	noise figure	LNA enable; bypass off <sup>[1]</sup>	-	1.1	1.8	dB
$\Delta G$	gain variation	$700 \text{ MHz} \leq f \leq 1500 \text{ MHz}$	-	5.5	-	dB
$P_{L(1dB)}$	output power at 1 dB gain compression	LNA enable; bypass off	19	20.5	-	dBm
IP <sub>3O</sub>	output third-order intercept point	2-tone; tone spacing = 1 MHz; $P_L = 5$ dBm per tone				
		LNA enable; bypass off	33.5	36.5	-	dBm
		LNA disable; bypass on	-	44	-	dBm
RL <sub>in</sub>	input return loss	LNA enable; bypass off	-	10	-	dB
		LNA disable; bypass on	-	15	-	dB
RL <sub>out</sub>	output return loss	LNA enable; bypass off	-	10	-	dB
		LNA disable; bypass on	-	15	-	dB
ISL	isolation	LNA disable; bypass off	-	30	-	dB
		LNA enable; bypass off	-	20	-	dB
$t_{s(pon)}$	power-on settling time	$P_i = -20$ dBm	-	0.5	-	$\mu$ s
$t_{s(poff)}$	power-off settling time	$P_i = -20$ dBm	-	0.1	-	$\mu$ s
K	Rollett stability factor	both on-state and off-state up to $f = 20$ GHz	1	-	-	-

[1] Connector and Printed-Circuit Board (PCB) losses have been de-embedded.

Table 8. Control truth table

 $V_{CC} = 5\text{ V}$ ;  $T_{amb} = 25\text{ }^{\circ}\text{C}$ .

Control signal setting <sup>[1]</sup>		Mode of operation	
CTRL2 (pin 1)	CTRL1 (pin 10)	LNA	bypass
HIGH	LOW	disable	on
HIGH	HIGH	disable	on
LOW	LOW	enable	off
LOW	HIGH	disable	off

- [1] A logic LOW is the result of an input voltage on that specific pin between  $-0.3\text{ V}$  and  $0.7\text{ V}$ .  
A logic HIGH is the result of an input voltage on that specific pin between  $1.2\text{ V}$  and  $3.6\text{ V}$ .

12 Graphics

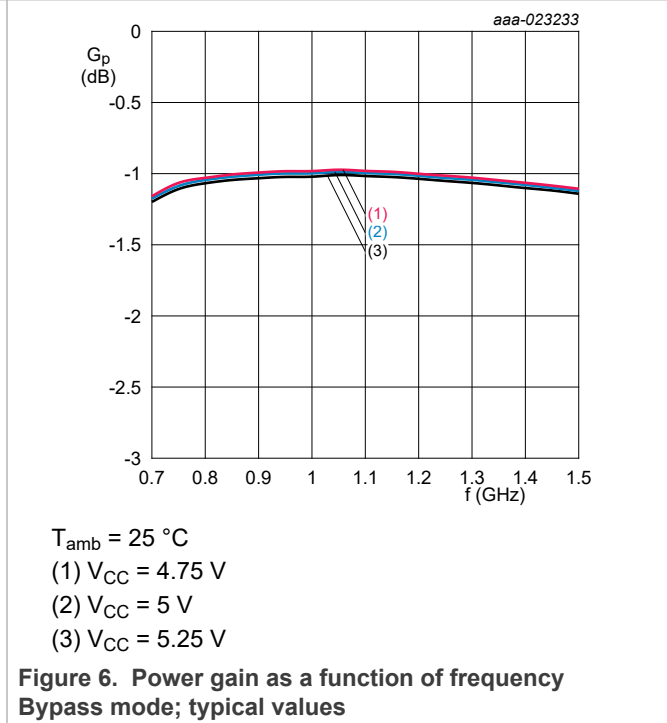
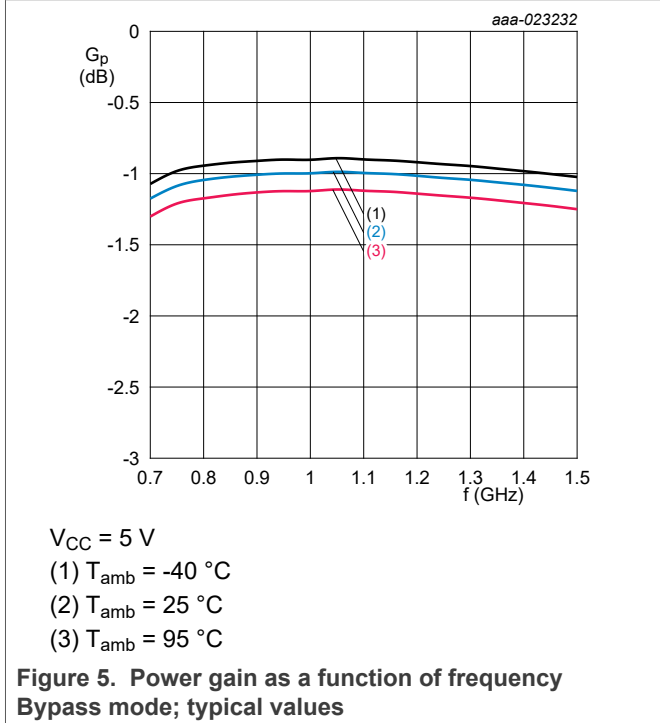
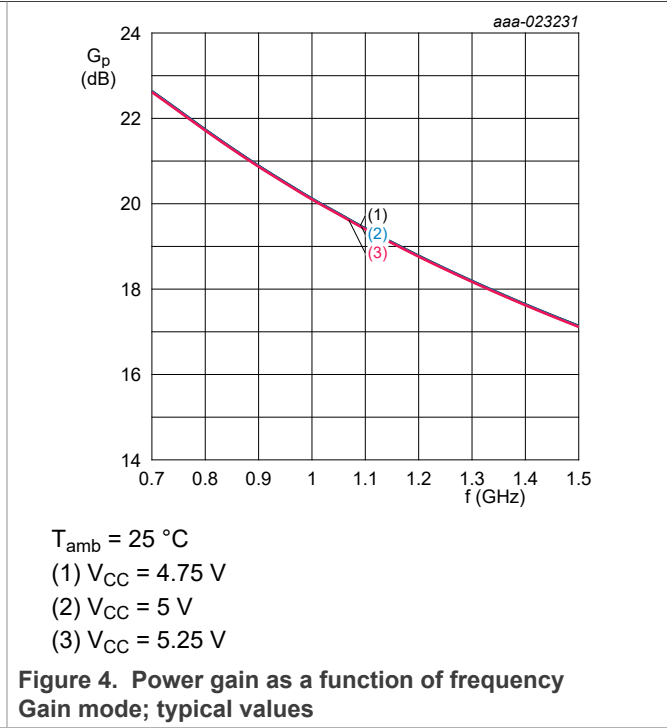
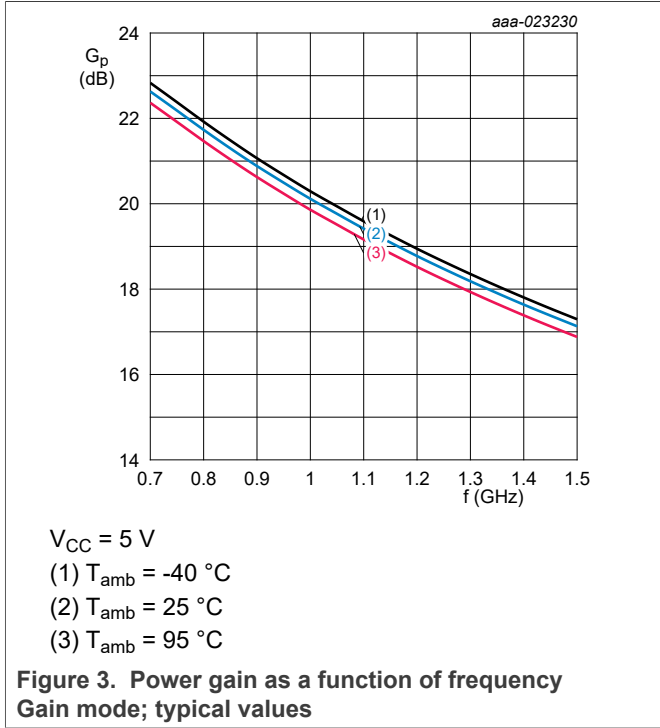

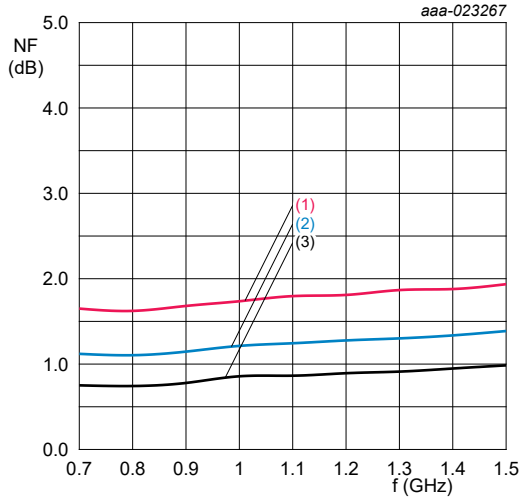

$V_{CC} = 5\text{ V}$   
 (1)  $T_{amb} = -40\text{ °C}$   
 (2)  $T_{amb} = 25\text{ °C}$   
 (3)  $T_{amb} = 95\text{ °C}$

Figure 7. Noise figure as a function of frequency  
 Gain mode; typical values

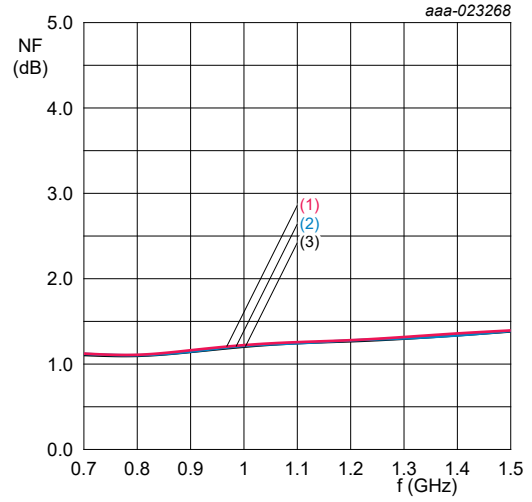

$T_{amb} = 25\text{ °C}$   
 (1)  $V_{CC} = 4.75\text{ V}$   
 (2)  $V_{CC} = 5\text{ V}$   
 (3)  $V_{CC} = 5.25\text{ V}$

Figure 8. Noise figure as a function of frequency  
 Gain mode; typical values

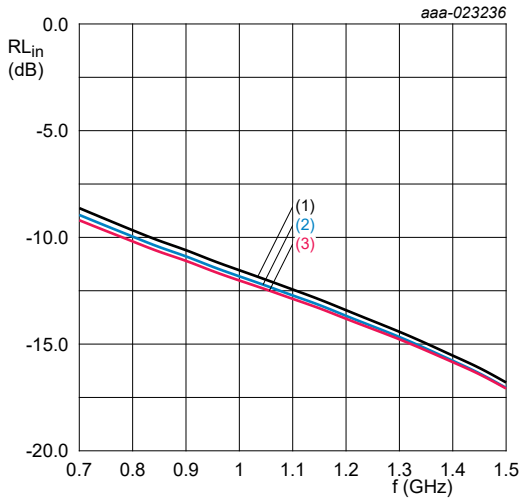

$V_{CC} = 5\text{ V}$   
 (1)  $T_{amb} = -40\text{ °C}$   
 (2)  $T_{amb} = 25\text{ °C}$   
 (3)  $T_{amb} = 95\text{ °C}$

Figure 9. Input return loss as a function of frequency  
 Gain mode; typical values

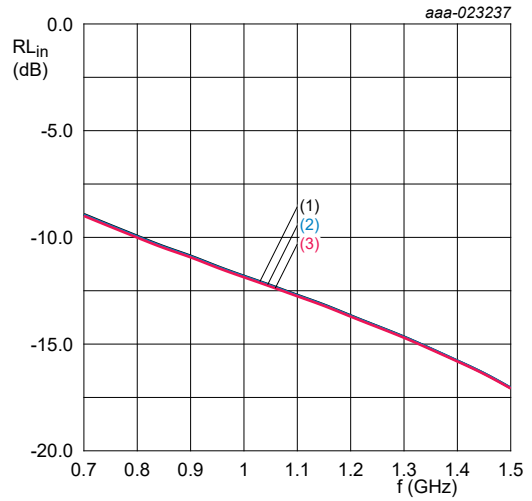

$T_{amb} = 25\text{ °C}$   
 (1)  $V_{CC} = 4.75\text{ V}$   
 (2)  $V_{CC} = 5\text{ V}$   
 (3)  $V_{CC} = 5.25\text{ V}$

Figure 10. Input return loss as a function of frequency  
 Gain mode; typical values



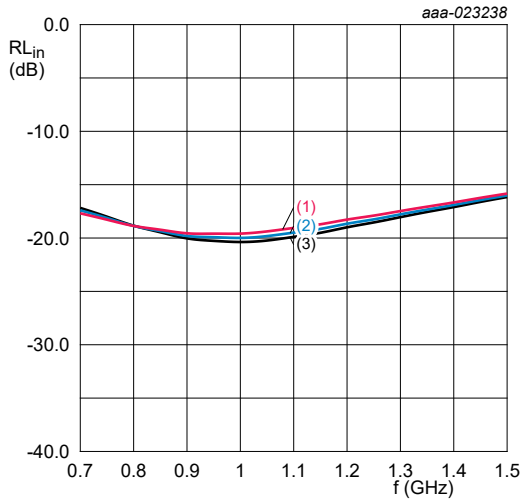

$V_{CC} = 5\text{ V}$   
 (1)  $T_{amb} = -40\text{ }^{\circ}\text{C}$   
 (2)  $T_{amb} = 25\text{ }^{\circ}\text{C}$   
 (3)  $T_{amb} = 95\text{ }^{\circ}\text{C}$

Figure 11. Input return loss as a function of frequency  
 Bypass mode; typical values

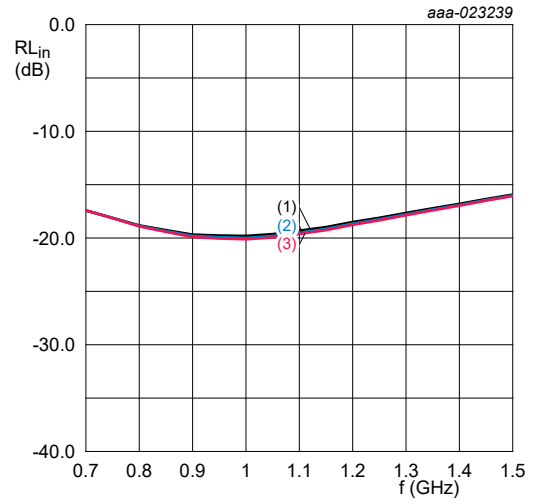

$T_{amb} = 25\text{ }^{\circ}\text{C}$   
 (1)  $V_{CC} = 4.75\text{ V}$   
 (2)  $V_{CC} = 5\text{ V}$   
 (3)  $V_{CC} = 5.25\text{ V}$

Figure 12. Input return loss as a function of frequency  
 Bypass mode; typical values

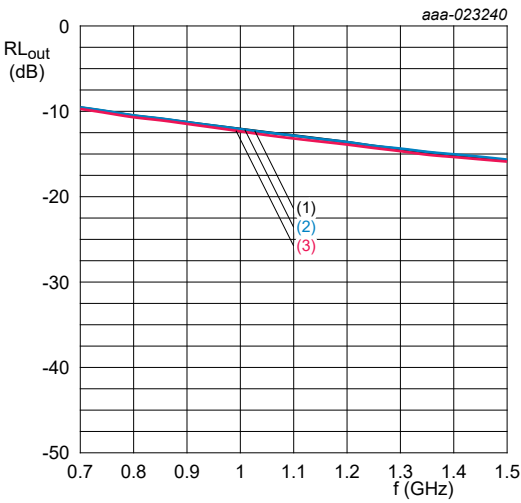

$V_{CC} = 5\text{ V}$   
 (1)  $T_{amb} = -40\text{ }^{\circ}\text{C}$   
 (2)  $T_{amb} = 25\text{ }^{\circ}\text{C}$   
 (3)  $T_{amb} = 95\text{ }^{\circ}\text{C}$

Figure 13. Output return loss as a function of frequency  
 Gain mode; typical values

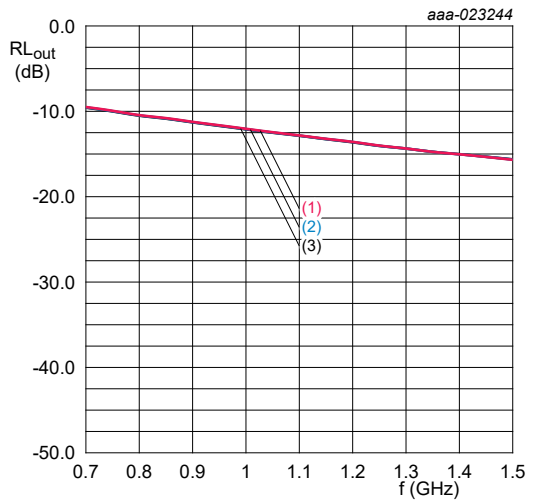

$T_{amb} = 25\text{ }^{\circ}\text{C}$   
 (1)  $V_{CC} = 4.75\text{ V}$   
 (2)  $V_{CC} = 5\text{ V}$   
 (3)  $V_{CC} = 5.25\text{ V}$

Figure 14. Output return loss as a function of frequency  
 Gain mode; typical values

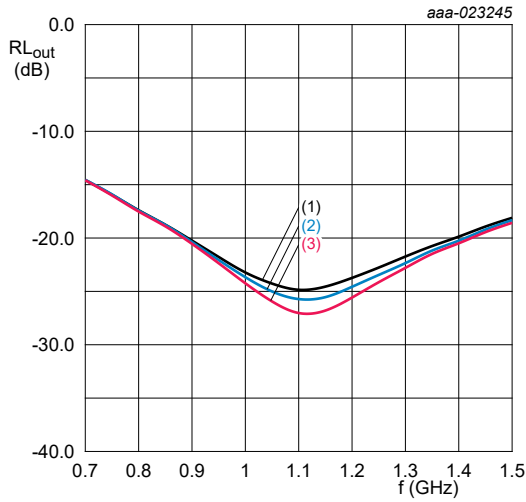

$V_{CC} = 5\text{ V}$   
 (1)  $T_{amb} = -40\text{ °C}$   
 (2)  $T_{amb} = 25\text{ °C}$   
 (3)  $T_{amb} = 95\text{ °C}$

Figure 15. Output return loss as a function of frequency  
 Bypass mode; typical values

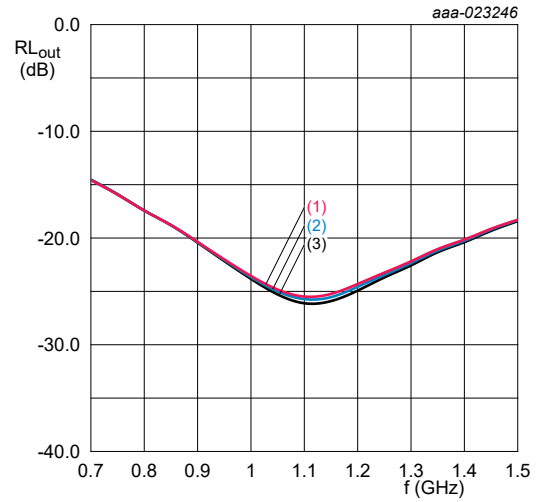

$T_{amb} = 25\text{ °C}$   
 (1)  $V_{CC} = 4.75\text{ V}$   
 (2)  $V_{CC} = 5\text{ V}$   
 (3)  $V_{CC} = 5.25\text{ V}$

Figure 16. Output return loss as a function of frequency  
 Bypass mode; typical values

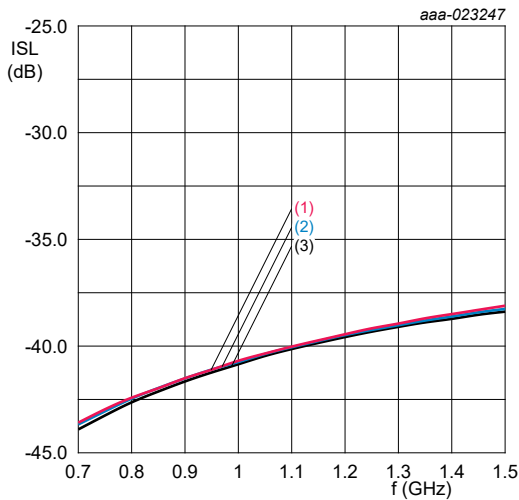

$V_{CC} = 5\text{ V}$   
 (1)  $T_{amb} = -40\text{ °C}$   
 (2)  $T_{amb} = 25\text{ °C}$   
 (3)  $T_{amb} = 95\text{ °C}$

Figure 17. Isolation as a function of frequency  
 Isolation mode; typical values

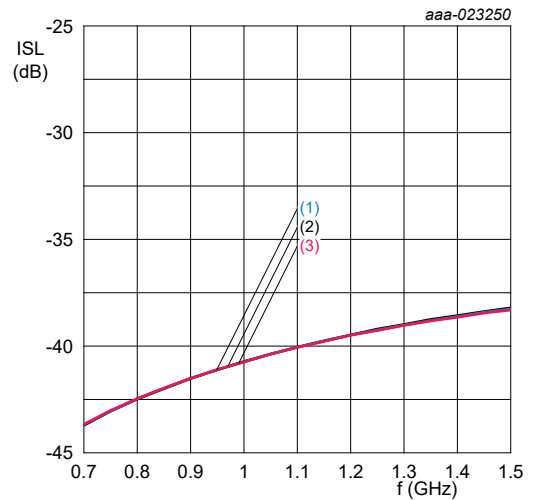

$T_{amb} = 25\text{ °C}$   
 (1)  $V_{CC} = 4.75\text{ V}$   
 (2)  $V_{CC} = 5\text{ V}$   
 (3)  $V_{CC} = 5.25\text{ V}$

Figure 18. Isolation as a function of frequency  
 Isolation mode; typical values

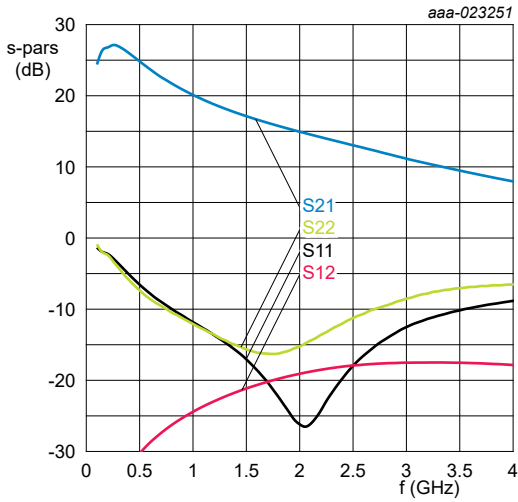

$V_{CC} = 5\text{ V}; T_{amb} = 25\text{ }^{\circ}\text{C}$

Figure 19. Wideband S-parameters as function of frequency Gain mode; typical values

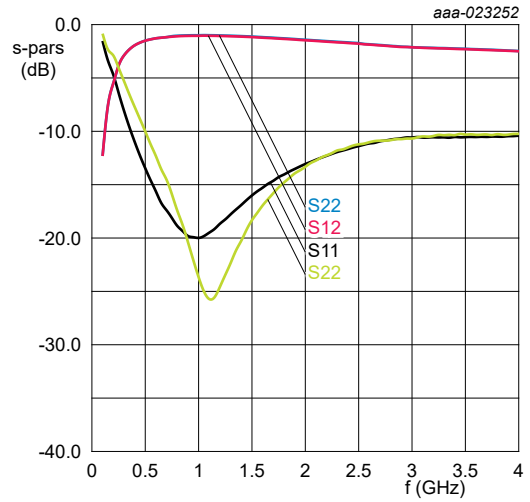

$V_{CC} = 5\text{ V}; T_{amb} = 25\text{ }^{\circ}\text{C}$

Figure 20. Wideband S-parameters as function of frequency Bypass mode; typical values

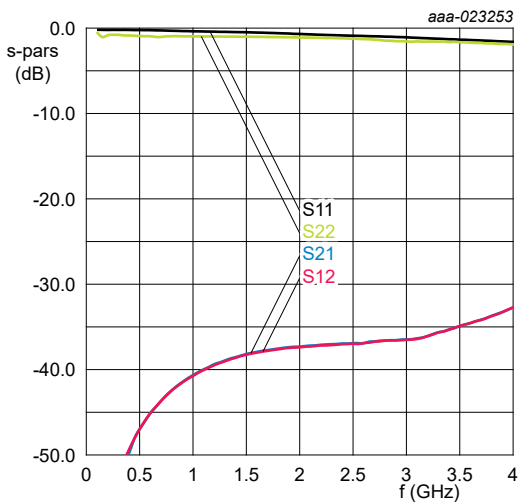

$V_{CC} = 5\text{ V}; T_{amb} = 25\text{ }^{\circ}\text{C}$

Figure 21. Wideband S-parameters as function of frequency Isolation mode; typical values

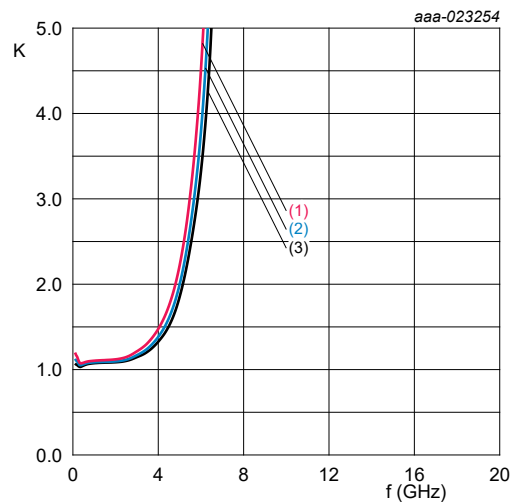

$V_{CC} = 5\text{ V}$   
 (1)  $T_{amb} = -40\text{ }^{\circ}\text{C}$   
 (2)  $T_{amb} = 25\text{ }^{\circ}\text{C}$   
 (3)  $T_{amb} = 95\text{ }^{\circ}\text{C}$

Figure 22. Rollett stability factor as function of frequency Gain mode; typical values

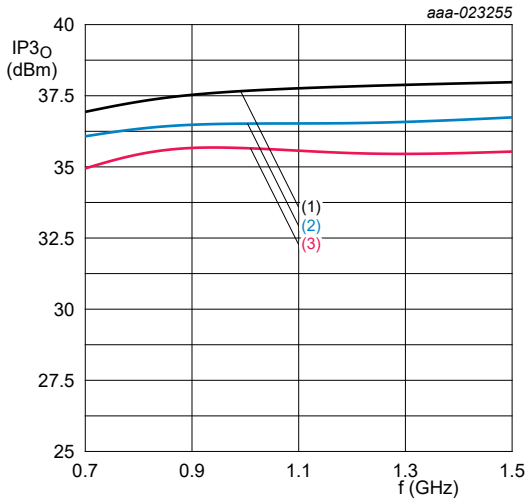

$V_{CC} = 5\text{ V}$   
 (1)  $T_{amb} = -40\text{ }^{\circ}\text{C}$   
 (2)  $T_{amb} = 25\text{ }^{\circ}\text{C}$   
 (3)  $T_{amb} = 95\text{ }^{\circ}\text{C}$

Figure 23. Output third-order intercept point as a function of frequency Gain mode; typical values

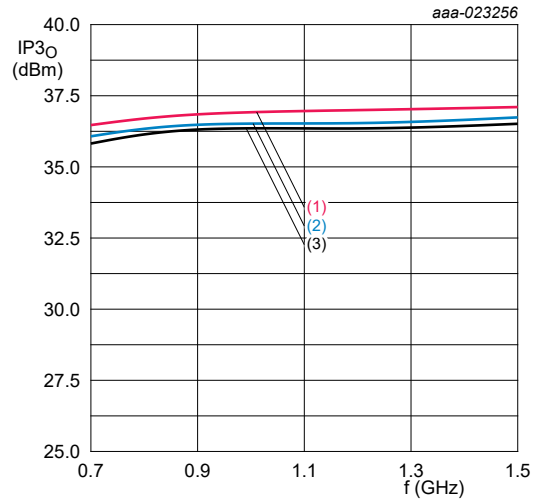

$T_{amb} = 25\text{ }^{\circ}\text{C}$   
 (1)  $V_{CC} = 4.75\text{ V}$   
 (2)  $V_{CC} = 5\text{ V}$   
 (3)  $V_{CC} = 5.25\text{ V}$

Figure 24. Output third-order intercept point as a function of frequency Gain mode; typical values

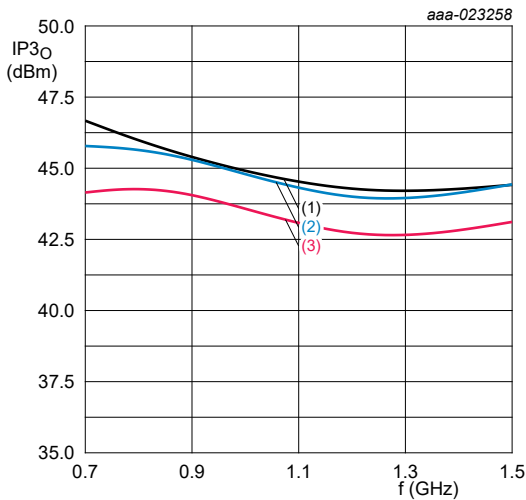

$V_{CC} = 5\text{ V}$   
 (1)  $T_{amb} = -40\text{ }^{\circ}\text{C}$   
 (2)  $T_{amb} = 25\text{ }^{\circ}\text{C}$   
 (3)  $T_{amb} = 95\text{ }^{\circ}\text{C}$

Figure 25. Output third-order intercept point as a function of frequency Bypass mode; typical values

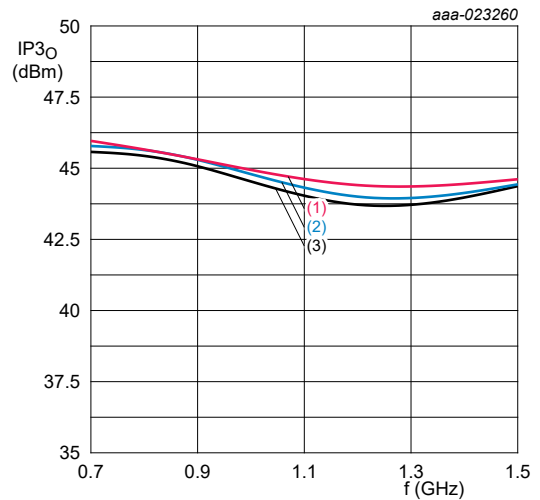

$T_{amb} = 25\text{ }^{\circ}\text{C}$   
 (1)  $V_{CC} = 4.75\text{ V}$   
 (2)  $V_{CC} = 5\text{ V}$   
 (3)  $V_{CC} = 5.25\text{ V}$

Figure 26. Output third-order intercept point as a function of frequency Bypass mode; typical values

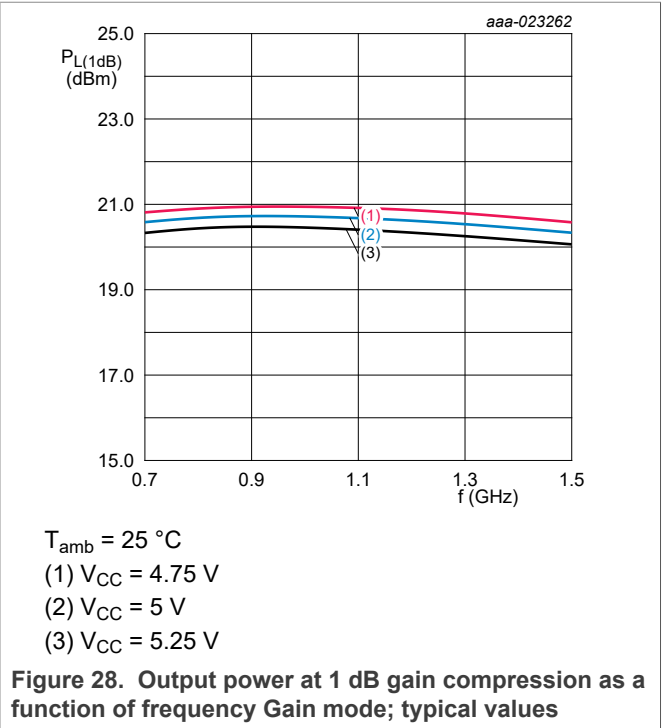
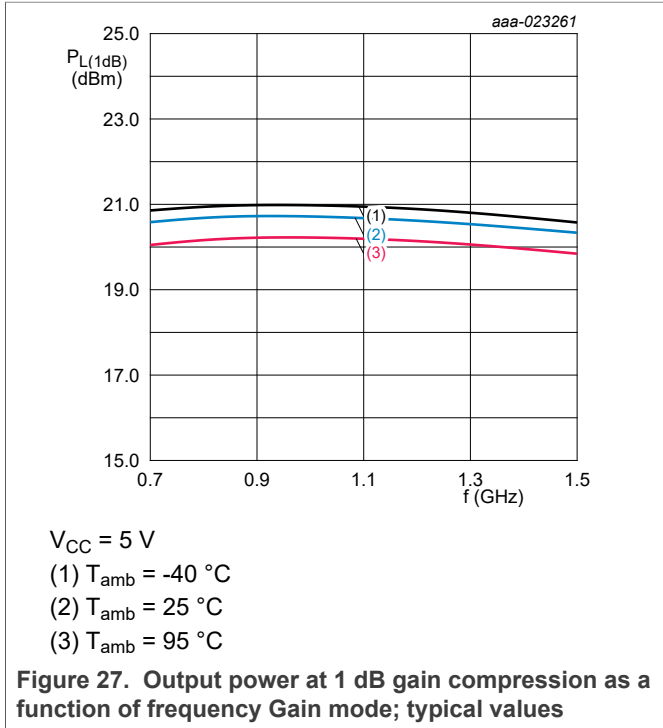

**13 Application information**

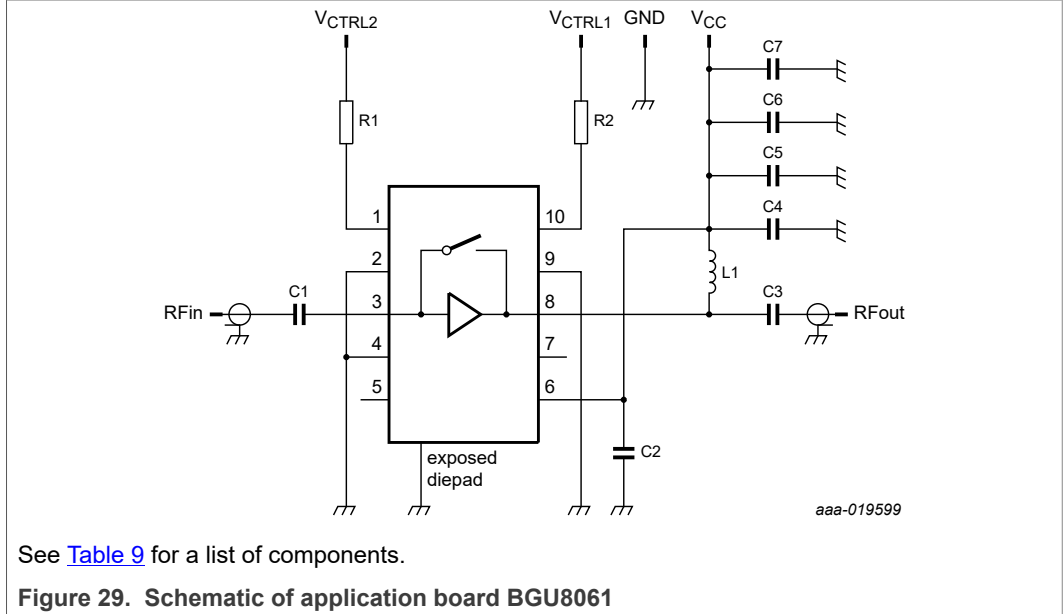

See [Table 9](#) for a list of components.

**Figure 29. Schematic of application board BGU8061**

**Table 9. List of components**

See [Figure 29](#) for schematics.

Component	Description	Value	Remarks
C1	capacitor	100 nF	
C2, C3	capacitor	100 pF	
C4	capacitor	1 nF	
C5	capacitor	-	optional
C6	capacitor	10 nF	
C7	capacitor	1 $\mu$ F	
L1	inductor	15 nH	
R1, R2	resistor	1 k $\Omega$	

14 Package outline

HVSON10: plastic thermal enhanced very thin small outline package; no leads;  
10 terminals; 3 x 3 x 0.85 mm

SOT650-2

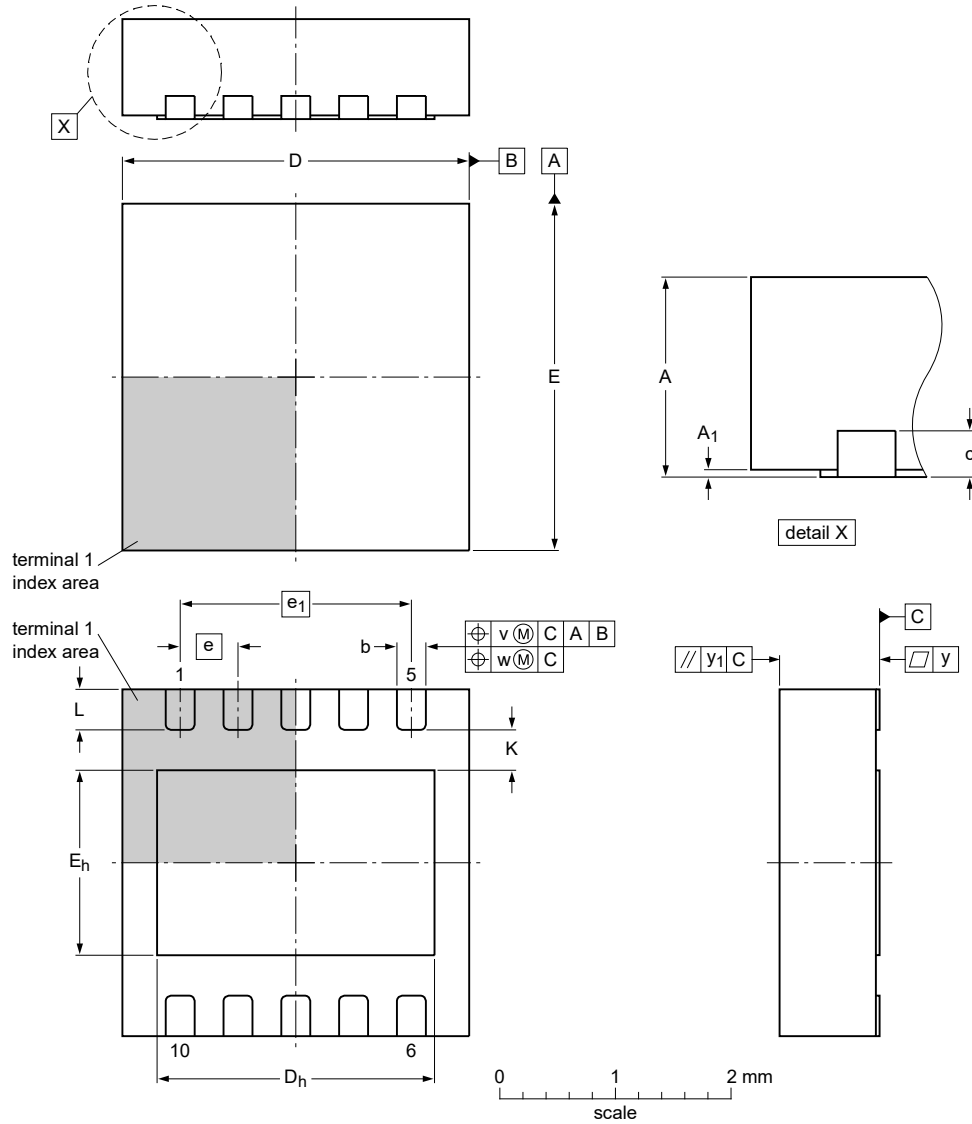

Dimensions

Unit	A <sup>(1)</sup>	A <sub>1</sub>	b	c	D <sup>(1)</sup>	D <sub>h</sub>	E <sup>(1)</sup>	E <sub>h</sub>	e	e <sub>1</sub>	K	L	v	w	y	y <sub>1</sub>
max	1.00	0.05	0.30		3.1	2.5	3.1	1.7			0.41	0.45				
nom	0.85	0.03	0.25	0.2	3.0	2.4	3.0	1.6	0.5	2	0.35	0.35	0.1	0.05	0.08	0.1
min	0.80	0.00	0.18		2.9	2.3	2.9	1.5			0.28	0.30				

Note

1. Plastic or metal protrusions of 0.075 mm maximum per side are not included.

sot650-2\_po

Outline version	References			European projection	Issue date
	IEC	JEDEC	JEITA		
SOT650-2	---	MO-229	---		09-03-16 09-03-18

Figure 30. Package Outline SOT650-2 (HVSON10)

## 15 Abbreviations

Table 10. Abbreviations

Acronym	Description
CDMA	code division multiple access
ESD	electrostatic discharge
FDD	frequency-division duplexing
GSM	global system for mobile communication
LNA	low noise amplifier
LTE	long-term evolution
TDD	time-division duplexing
W-CDMA	wideband code division multiple access

## 16 Revision history

Table 11. Revision history

Document ID	Release date	Data sheet status	Change notice	Supersedes
BGU8061 v.2.1	20220323	product data sheet	202203022I	BGU8061 v.2
Modifications	<ul style="list-style-type: none"> <li>added legal information</li> <li>adapted the data sheet to the latest NXP rules(no data is changed)</li> </ul>			
BGU8061 v.2	20170127	product data sheet	-	BGU8061 v.1
Modifications	<ul style="list-style-type: none"> <li>added BTS3001L according to our new naming convention</li> </ul>			
BGU8061 v.1	<tbd>	product data sheet	-	-



## 17 Legal information

### 17.1 Data sheet status

Document status <sup>[1][2]</sup>	Product status <sup>[3]</sup>	Definition
Objective [short] data sheet	Development	This document contains data from the objective specification for product development.
Preliminary [short] data sheet	Qualification	This document contains data from the preliminary specification.
Product [short] data sheet	Production	This document contains the product specification.

[1] Please consult the most recently issued document before initiating or completing a design.

[2] The term 'short data sheet' is explained in section "Definitions".

[3] The product status of device(s) described in this document may have changed since this document was published and may differ in case of multiple devices. The latest product status information is available on the Internet at URL <http://www.nxp.com>.

### 17.2 Definitions

**Draft** — A draft status on a document indicates that the content is still under internal review and subject to formal approval, which may result in modifications or additions. NXP Semiconductors does not give any representations or warranties as to the accuracy or completeness of information included in a draft version of a document and shall have no liability for the consequences of use of such information.

**Short data sheet** — A short data sheet is an extract from a full data sheet with the same product type number(s) and title. A short data sheet is intended for quick reference only and should not be relied upon to contain detailed and full information. For detailed and full information see the relevant full data sheet, which is available on request via the local NXP Semiconductors sales office. In case of any inconsistency or conflict with the short data sheet, the full data sheet shall prevail.

**Product specification** — The information and data provided in a Product data sheet shall define the specification of the product as agreed between NXP Semiconductors and its customer, unless NXP Semiconductors and customer have explicitly agreed otherwise in writing. In no event however, shall an agreement be valid in which the NXP Semiconductors product is deemed to offer functions and qualities beyond those described in the Product data sheet.

### 17.3 Disclaimers

**Limited warranty and liability** — Information in this document is believed to be accurate and reliable. However, NXP Semiconductors does not give any representations or warranties, expressed or implied, as to the accuracy or completeness of such information and shall have no liability for the consequences of use of such information. NXP Semiconductors takes no responsibility for the content in this document if provided by an information source outside of NXP Semiconductors.

In no event shall NXP Semiconductors be liable for any indirect, incidental, punitive, special or consequential damages (including - without limitation - lost profits, lost savings, business interruption, costs related to the removal or replacement of any products or rework charges) whether or not such damages are based on tort (including negligence), warranty, breach of contract or any other legal theory.

Notwithstanding any damages that customer might incur for any reason whatsoever, NXP Semiconductors' aggregate and cumulative liability towards customer for the products described herein shall be limited in accordance with the Terms and conditions of commercial sale of NXP Semiconductors.

**Right to make changes** — NXP Semiconductors reserves the right to make changes to information published in this document, including without limitation specifications and product descriptions, at any time and without notice. This document supersedes and replaces all information supplied prior to the publication hereof.

**Suitability for use** — NXP Semiconductors products are not designed, authorized or warranted to be suitable for use in life support, life-critical or safety-critical systems or equipment, nor in applications where failure or malfunction of an NXP Semiconductors product can reasonably be expected to result in personal injury, death or severe property or environmental damage. NXP Semiconductors and its suppliers accept no liability for inclusion and/or use of NXP Semiconductors products in such equipment or applications and therefore such inclusion and/or use is at the customer's own risk.

**Applications** — Applications that are described herein for any of these products are for illustrative purposes only. NXP Semiconductors makes no representation or warranty that such applications will be suitable for the specified use without further testing or modification.

Customers are responsible for the design and operation of their applications and products using NXP Semiconductors products, and NXP Semiconductors accepts no liability for any assistance with applications or customer product design. It is customer's sole responsibility to determine whether the NXP Semiconductors product is suitable and fit for the customer's applications and products planned, as well as for the planned application and use of customer's third party customer(s). Customers should provide appropriate design and operating safeguards to minimize the risks associated with their applications and products.

NXP Semiconductors does not accept any liability related to any default, damage, costs or problem which is based on any weakness or default in the customer's applications or products, or the application or use by customer's third party customer(s). Customer is responsible for doing all necessary testing for the customer's applications and products using NXP Semiconductors products in order to avoid a default of the applications and the products or of the application or use by customer's third party customer(s). NXP does not accept any liability in this respect.

**Limiting values** — Stress above one or more limiting values (as defined in the Absolute Maximum Ratings System of IEC 60134) will cause permanent damage to the device. Limiting values are stress ratings only and (proper) operation of the device at these or any other conditions above those given in the Recommended operating conditions section (if present) or the Characteristics sections of this document is not warranted. Constant or repeated exposure to limiting values will permanently and irreversibly affect the quality and reliability of the device.

**Terms and conditions of commercial sale** — NXP Semiconductors products are sold subject to the general terms and conditions of commercial sale, as published at <http://www.nxp.com/profile/terms>, unless otherwise agreed in a valid written individual agreement. In case an individual agreement is concluded only the terms and conditions of the respective agreement shall apply. NXP Semiconductors hereby expressly objects to applying the customer's general terms and conditions with regard to the purchase of NXP Semiconductors products by customer.

**No offer to sell or license** — Nothing in this document may be interpreted or construed as an offer to sell products that is open for acceptance or the grant, conveyance or implication of any license under any copyrights, patents or other industrial or intellectual property rights.

**Quick reference data** — The Quick reference data is an extract of the product data given in the Limiting values and Characteristics sections of this document, and as such is not complete, exhaustive or legally binding.

**Export control** — This document as well as the item(s) described herein may be subject to export control regulations. Export might require a prior authorization from competent authorities.

**Suitability for use in non-automotive qualified products** — Unless this data sheet expressly states that this specific NXP Semiconductors product is automotive qualified, the product is not suitable for automotive use. It is neither qualified nor tested in accordance with automotive testing or application requirements. NXP Semiconductors accepts no liability for inclusion and/or use of non-automotive qualified products in automotive equipment or applications.

In the event that customer uses the product for design-in and use in automotive applications to automotive specifications and standards, customer (a) shall use the product without NXP Semiconductors' warranty of the product for such automotive applications, use and specifications, and (b) whenever customer uses the product for automotive applications beyond NXP Semiconductors' specifications such use shall be solely at customer's own risk, and (c) customer fully indemnifies NXP Semiconductors for any liability, damages or failed product claims resulting from customer design and use of the product for automotive applications beyond NXP Semiconductors' standard warranty and NXP Semiconductors' product specifications.

**Translations** — A non-English (translated) version of a document is for reference only. The English version shall prevail in case of any discrepancy between the translated and English versions.

**Security** — Customer understands that all NXP products may be subject to unidentified vulnerabilities or may support established security standards or specifications with known limitations. Customer is responsible for the design and operation of its applications and products throughout their lifecycles to reduce the effect of these vulnerabilities on customer's applications and products. Customer's responsibility also extends to other open and/or proprietary technologies supported by NXP products for use in customer's applications. NXP accepts no liability for any vulnerability. Customer should regularly check security updates from NXP and follow up appropriately.

Customer shall select products with security features that best meet rules, regulations, and standards of the intended application and make the ultimate design decisions regarding its products and is solely responsible for compliance with all legal, regulatory, and security related requirements concerning its products, regardless of any information or support that may be provided by NXP.

NXP has a Product Security Incident Response Team (PSIRT) (reachable at [PSIRT@nxp.com](mailto:PSIRT@nxp.com)) that manages the investigation, reporting, and solution release to security vulnerabilities of NXP products.

## 17.4 Trademarks

Notice: All referenced brands, product names, service names, and trademarks are the property of their respective owners.

**NXP** — wordmark and logo are trademarks of NXP B.V.

## Contents

<b>1</b>	<b>General description .....</b>	<b>1</b>
<b>2</b>	<b>Features and benefits .....</b>	<b>1</b>
<b>3</b>	<b>Applications .....</b>	<b>1</b>
<b>4</b>	<b>Quick reference data .....</b>	<b>2</b>
<b>5</b>	<b>Ordering information .....</b>	<b>2</b>
<b>6</b>	<b>Block diagram .....</b>	<b>2</b>
<b>7</b>	<b>Pinning information .....</b>	<b>3</b>
7.1	Pinning .....	3
7.2	Pin description .....	3
<b>8</b>	<b>Limiting values .....</b>	<b>4</b>
<b>9</b>	<b>Recommended operating conditions .....</b>	<b>4</b>
<b>10</b>	<b>Thermal characteristics .....</b>	<b>4</b>
<b>11</b>	<b>Characteristics .....</b>	<b>5</b>
<b>12</b>	<b>Graphics .....</b>	<b>7</b>
<b>13</b>	<b>Application information .....</b>	<b>14</b>
<b>14</b>	<b>Package outline .....</b>	<b>15</b>
<b>15</b>	<b>Abbreviations .....</b>	<b>16</b>
<b>16</b>	<b>Revision history .....</b>	<b>16</b>
<b>17</b>	<b>Legal information .....</b>	<b>17</b>

---

Please be aware that important notices concerning this document and the product(s) described herein, have been included in section 'Legal information'.

---

© NXP B.V. 2022.

All rights reserved.

For more information, please visit: <http://www.nxp.com>

For sales office addresses, please send an email to: [salesaddresses@nxp.com](mailto:salesaddresses@nxp.com)

Date of release: 23 March 2022  
 Document identifier: BGU8061