



# HMC215LP4 / 215LP4E

## GaAs MMIC MIXER w/ INTEGRATED LO AMPLIFIER, 1.7 - 4.0 GHz

### Typical Applications

The HMC215LP4 / HMC215LP4E is ideal for Wireless Infrastructure Applications:

- PCS / 3G Infrastructure
- Base Stations & Repeaters
- WiMAX & WiBro
- ISM & Fixed Wireless

### Features

- Input IP3: +25 dBm
- Low Input LO Drive: +2 to +6 dBm
- High LO to RF Isolation: 32 dB
- Low Conversion Loss: 8 dB
- Single Positive Supply: +5V @ 56 mA
- 24 Lead Ceramic 4x4mm SMT Package: 16mm<sup>2</sup>

### Functional Diagram

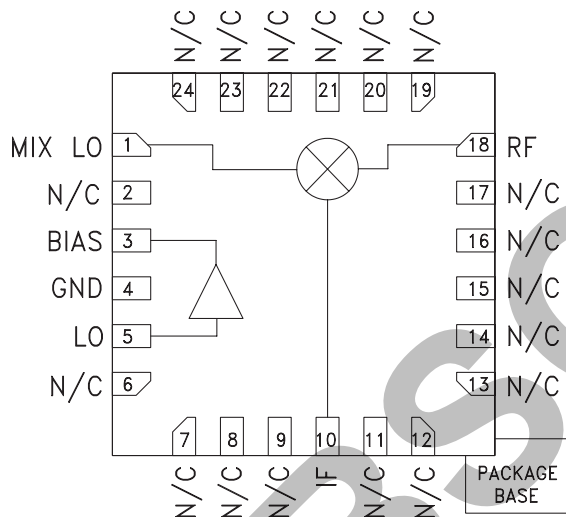

### General Description

The HMC215LP4 & HMC215LP4E are high linearity, double-balanced converter ICs that operate from 1.7 to 4.0 GHz and deliver a +25 dBm input third order intercept point. The LO amplifier output and high dynamic range mixer input are positioned so that an external LO filter can be placed in series between them. The converter provides 32 dB of LO to RF isolation and is ideal for upconverter and down-converter applications. The IC operates from a single +5V supply consuming 56 mA of current and accepts a LO drive level of 2 to 6 dBm. The design requires no external baluns and supports IF frequencies between DC and 1 GHz. The HMC215LP4(E) is pin for pin compatible with the HMC552LP4(E), which operates from 1.6 to 3.0 GHz.

### Electrical Specifications, $T_A = +25^\circ\text{C}$ , LO = +4 dBm, Vcc = +5V, IF = 100 MHz\*

Parameter	Min.	Typ.	Max.	Units
Frequency Range, RF, LO	1.7 - 4.0			GHz
Frequency Range, IF	DC - 1.0			GHz
Conversion Loss		8.0	11	dB
Noise Figure (SSB)		8.5		dB
LO to RF Isolation	23	32		dB
LO to IF Isolation	10	20		dB
IP3 (Input)		25		dBm
1 dB Compression (Input)		17		dBm
LO Drive Input Level (Typical)	2 to 6			dBm
Supply Current (Icc)		56	60	mA

\*Unless otherwise noted, all measurements performed as a downconverter, with low side LO and configured as shown in application circuit.



**Conversion Gain vs. Temperature**

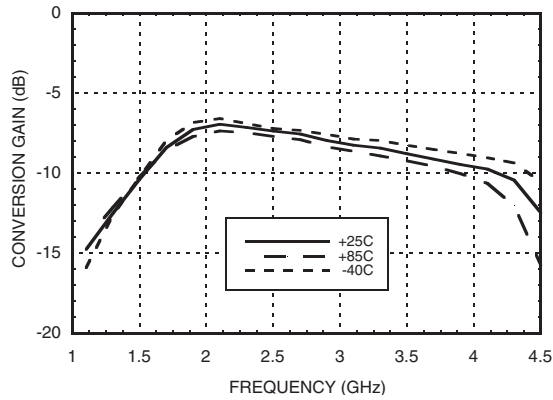

**Isolation**

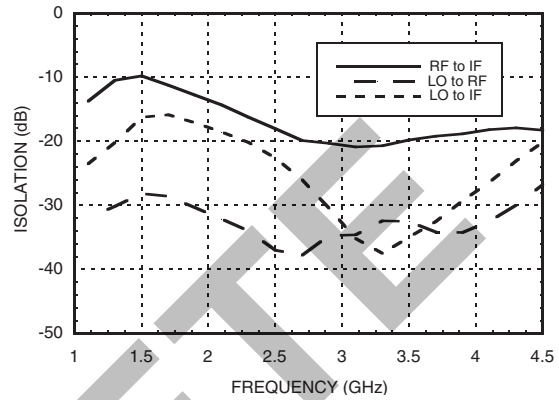

**Conversion Gain vs. LO Drive**

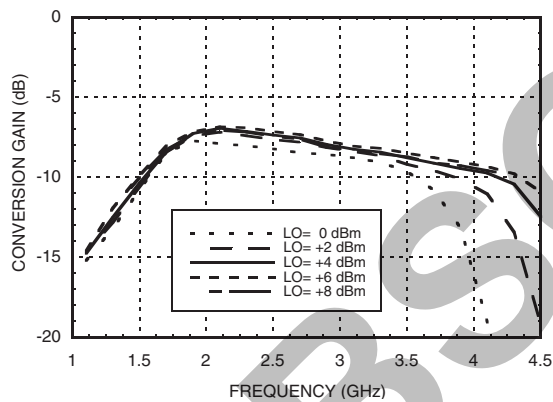

**Return Loss**

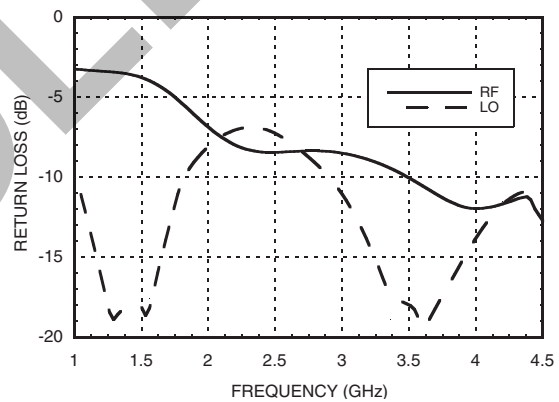

**Upconverter Performance  
Conversion Gain vs. LO Drive**

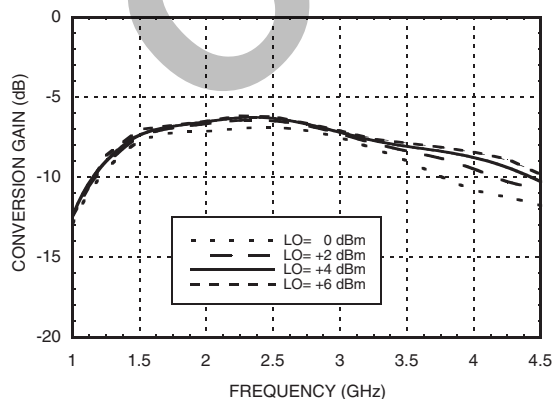

**IF Bandwidth**

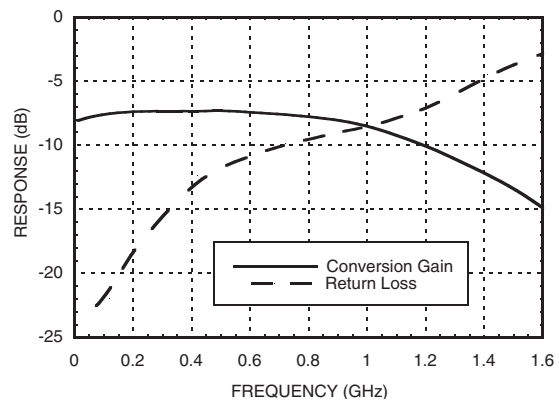

Information furnished by Analog Devices is believed to be accurate and reliable. However, no responsibility is assumed by Analog Devices for its use, nor for any infringements of patents or other rights of third parties that may result from its use. Specifications subject to change without notice. No license is granted by implication or otherwise under any patent or patent rights of Analog Devices. Trademarks and registered trademarks are the property of their respective owners.

For price, delivery, and to place orders: Analog Devices, Inc., One Technology Way, P.O. Box 9106, Norwood, MA 02062-9106 Phone: 781-329-4700 • Order online at [www.analog.com](http://www.analog.com) Application Support: Phone: 1-800-ANALOG-D



**GaAs MMIC MIXER w/ INTEGRATED LO AMPLIFIER, 1.7 - 4.0 GHz**

**Input IP3 vs. Temperature**

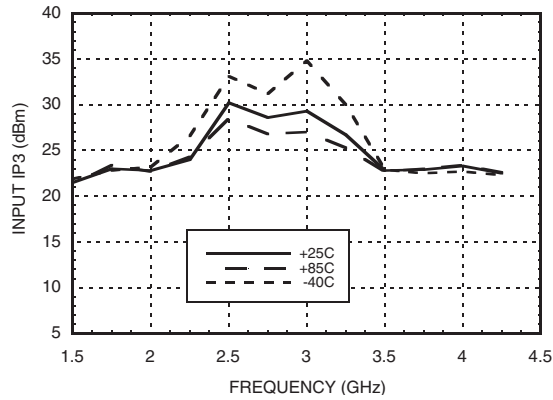

**Input IP3 vs. LO Drive**

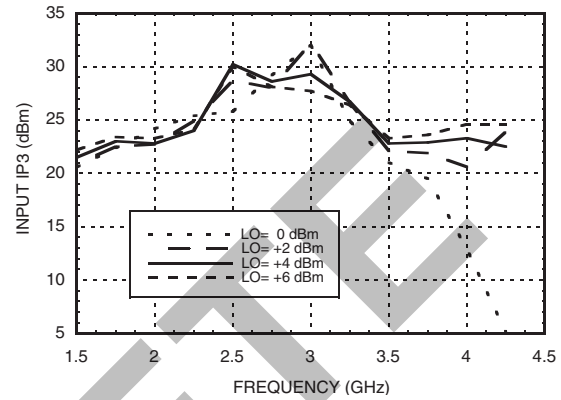

**Input IP2 vs. Temperature**

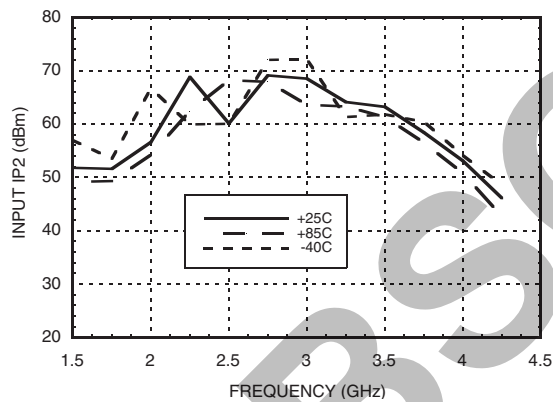

**Input IP2 vs. LO Drive**

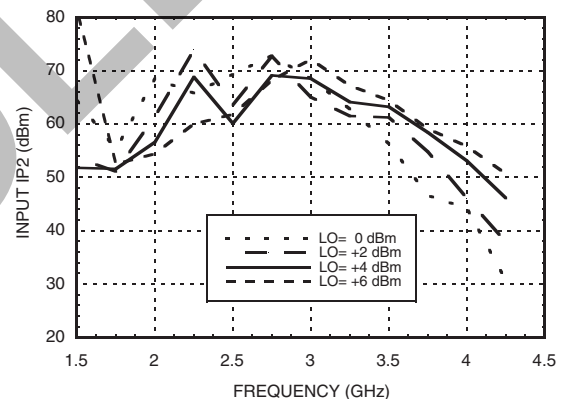

**Input P1dB vs. Temperature**

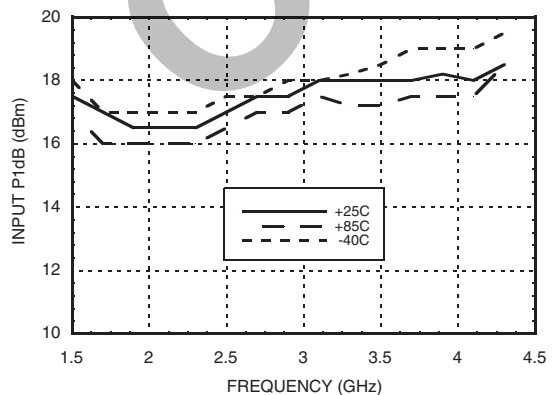

**MxN Spurious @ IF Port**

mRF	nLO				
	0	1	2	3	4
0	xx	-4	10	14	32
1	5	0	22	37	49
2	78	66	60	63	93
3	83	97	92	80	80
4	103	101	106	105	101

RF Freq. = 1.9 GHz @ -10 dBm  
 LO Freq. = 1.8 GHz @ 4 dBm  
 All values in dBc relative to the IF power level.

Information furnished by Analog Devices is believed to be accurate and reliable. However, no responsibility is assumed by Analog Devices for its use, nor for any infringements of patents or other rights of third parties that may result from its use. Specifications subject to change without notice. No license is granted by implication or otherwise under any patent or patent rights of Analog Devices. Trademarks and registered trademarks are the property of their respective owners.

For price, delivery, and to place orders: Analog Devices, Inc., One Technology Way, P.O. Box 9106, Norwood, MA 02062-9106 Phone: 781-329-4700 • Order online at [www.analog.com](http://www.analog.com) Application Support: Phone: 1-800-ANALOG-D

## GaAs MMIC MIXER w/ INTEGRATED LO AMPLIFIER, 1.7 - 4.0 GHz



### Harmonics of LO

LO Freq. (GHz)	nLO Spur @ RF Port			
	1	2	3	4
1.0	32	40	27	40
1.4	28	19	25	30
1.8	29	16	30	42
2.2	33	18	27	44
2.6	35	23	34	41
3.0	34	20	41	44

LO = 4 dBm  
All values in dBc below input LO level measured at RF port.

### Typical Supply Current

Vcc	Icc (mA)
+5.0	56 mA

### Absolute Maximum Ratings

RF / IF Input (Vcc= +5V)	+22 dBm
LO Drive (Vcc= +5V)	+10 dBm
BIAS	+7 Vdc
Junction Temperature	150°C
Continuous Pdis (T = 85°C) (derate 5.21 mW/°C above 85°C)	0.339 W
Thermal Resistance (junction to ground paddle)	192 °C/W
Storage Temperature	-65 to +150°C
Operating Temperature	-40 to +85°C

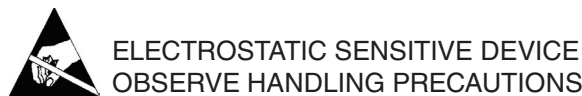

### Outline Drawing

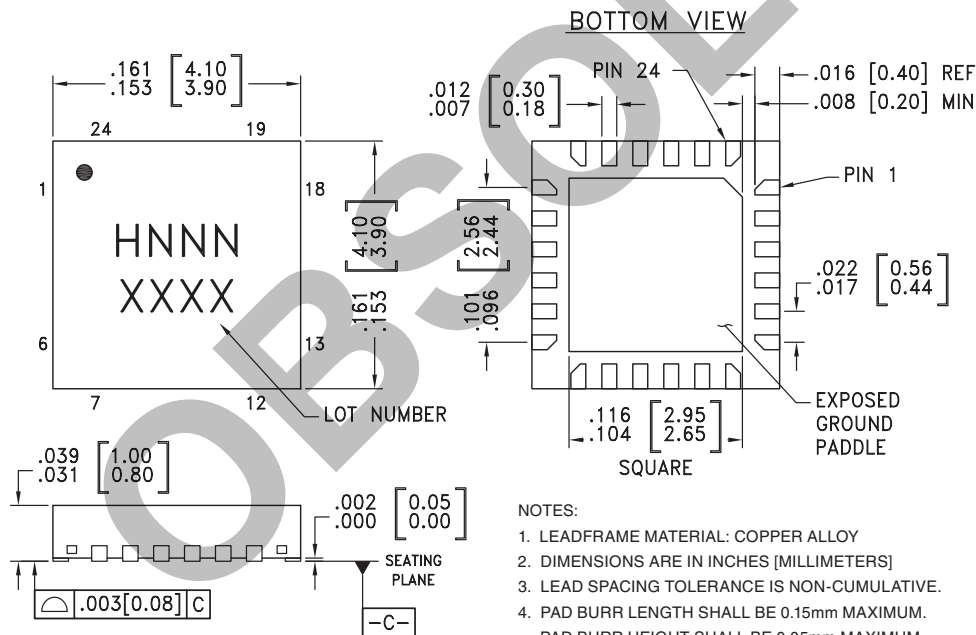

#### NOTES:

- LEADFRAME MATERIAL: COPPER ALLOY
- DIMENSIONS ARE IN INCHES [MILLIMETERS]
- LEAD SPACING TOLERANCE IS NON-CUMULATIVE.
- PAD BURR LENGTH SHALL BE 0.15mm MAXIMUM.  
PAD BURR HEIGHT SHALL BE 0.05mm MAXIMUM.
- PACKAGE WARP SHALL NOT EXCEED 0.05mm.
- ALL GROUND LEADS AND GROUND PADDLE MUST BE SOLDERED TO PCB RF GROUND.
- REFER TO HITTITE APPLICATION NOTE FOR SUGGESTED LAND PATTERN.

### Package Information

Part Number	Package Body Material	Lead Finish	MSL Rating	Package Marking <sup>[3]</sup>
HMC215LP4	Low Stress Injection Molded Plastic	Sn/Pb Solder	MSL1 <sup>[1]</sup>	H215 XXXX
HMC215LP4E	RoHS-compliant Low Stress Injection Molded Plastic	100% matte Sn	MSL1 <sup>[2]</sup>	H215 XXXX

[1] Max peak reflow temperature of 235 °C

[2] Max peak reflow temperature of 260 °C

[3] 4-Digit lot number XXXX



### Pin Descriptions

Pin Number	Function	Description	Interface Schematic
1	MIX LO	This pin is DC coupled and matched to 50 Ohms. An off chip DC blocking capacitor is required.	
2, 6 - 9, 11 - 17, 19 - 24	N/C	No connection. These pins may be connected to RF ground. Performance will not be affected.	
3	BIAS	Power supply for the LO amplifier. Three external bypass capacitors are recommended for optimum performance, as illustrated in the application circuit.	
4	GND	Backside of package has exposed metal ground paddle that must also be connected to ground.	
5	LO	This pin is DC coupled and matched to 50 Ohms from 1.7 to 4.0 GHz. An off chip DC blocking capacitor is required.	
10	IF	This pin is DC coupled. For applications not requiring operation to DC, this port should be DC blocked externally using a series capacitor whose value has been chosen to pass the necessary IF frequency range. For operation to DC, this pin must not source/sink more than 18 mA of current or die non-function and possible die failure will result.	
18	RF	This pin is DC coupled and matched to 50 Ohms.	

### Application Circuit

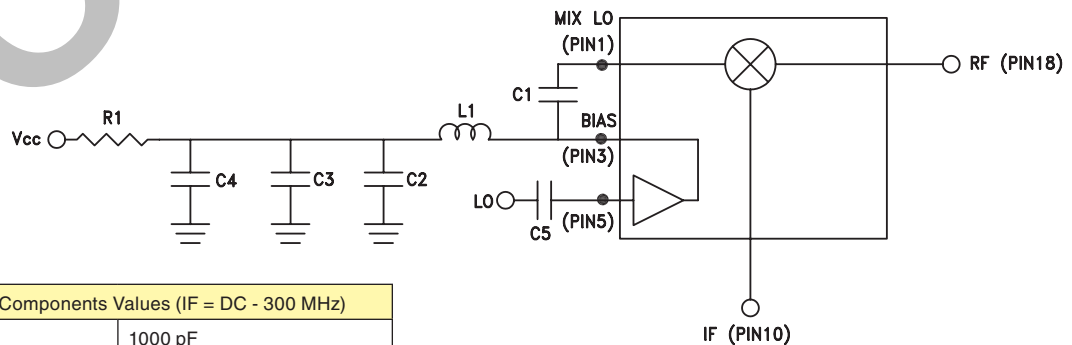

Recommended Components Values (IF = DC - 300 MHz)	
C3	1000 pF
C4	2.2 μF
C1, C2, C5	100 pF
L1	18 nH
R1	18 Ohm

Information furnished by Analog Devices is believed to be accurate and reliable. However, no responsibility is assumed by Analog Devices for its use, nor for any infringements of patents or other rights of third parties that may result from its use. Specifications subject to change without notice. No license is granted by implication or otherwise under any patent or patent rights of Analog Devices. Trademarks and registered trademarks are the property of their respective owners.

For price, delivery, and to place orders: Analog Devices, Inc., One Technology Way, P.O. Box 9106, Norwood, MA 02062-9106  
 Phone: 781-329-4700 • Order online at [www.analog.com](http://www.analog.com)  
 Application Support: Phone: 1-800-ANALOG-D

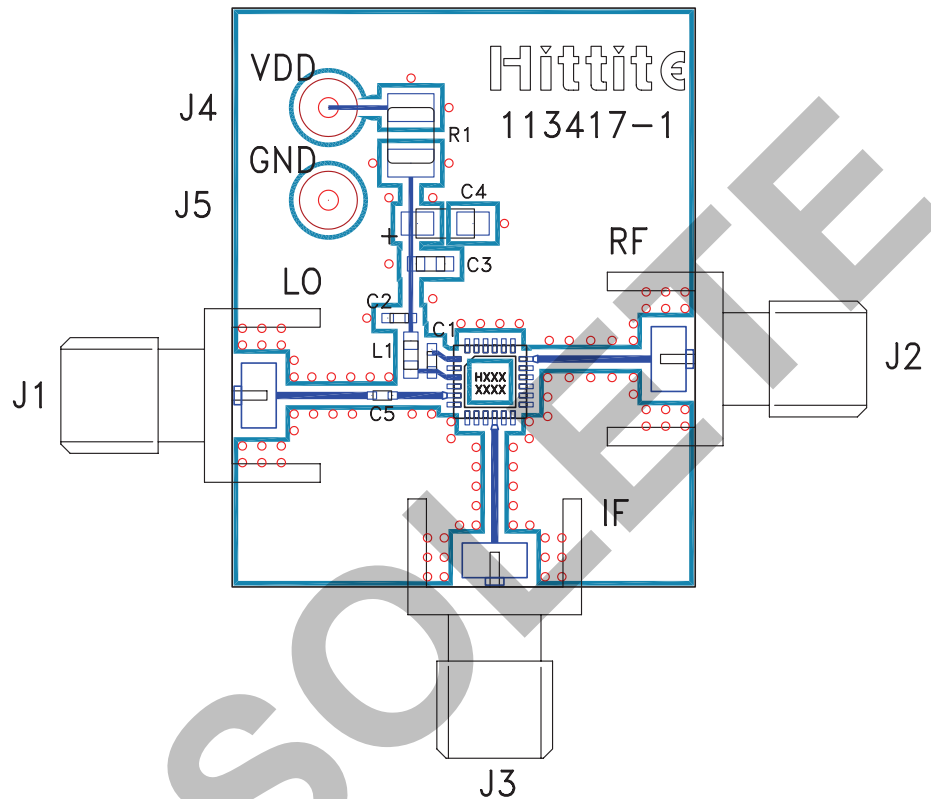
**Evaluation PCB**

**List of Materials for Evaluation PCB 115820 [1]**

Item	Description
J1 - J3	PCB Mount SMA RF Connector
J4, J5	DC Pin
C1, C2, C5	100 pF Chip Capacitor, 0402 Pkg.
C3	1000 pF Chip Capacitor, 0603 Pkg.
C4	2.2 $\mu$ F Capacitor, Tantalum
L1	18 nH Chip Inductor, 0603 Pkg.
R1	18 Ohm Resistor, 1210 1/8 watt Pkg.
U1	HMC215LP4 / HMC215LP4E
PCB [2]	113417 Evaluation Board

[1] Reference this number when ordering complete evaluation PCB

[2] Circuit Board Material: Rogers 4350

The circuit board used in the application should use RF circuit design techniques. Signal lines should have 50 Ohm impedance while the package ground leads and exposed paddle should be connected directly to the ground plane similar to that shown. A sufficient number of via holes should be used to connect the top and bottom ground planes. The evaluation circuit board shown is available from Hittite upon request.