

Key-Type Selector Switch

A22K

Install in 22-mm dia. or 25-mm dia.
Panel Cutout

- Locking lever ensures easy mounting and removal of switch unit
- Increase wiring efficiency and decrease mounting depth with three-row mounting of switch unit contact blocks
- Finger-safe contacts
- Use optional 25-mm dia. ring to install in 25-mm dia. panel cutouts
- Install using either round, forked crimp terminals, or ferrules
- IP65 oil resistant: EN60947-5-1

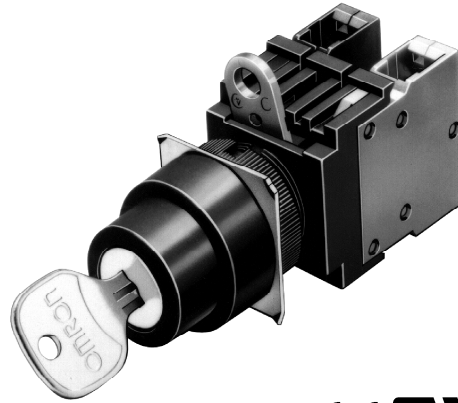

This product was manufactured at OMRON Izumo. OMRON Izumo has obtained approvals from international certification bodies for its quality system and environmental control system.

Ordering Information

■ CONSTRUCTION

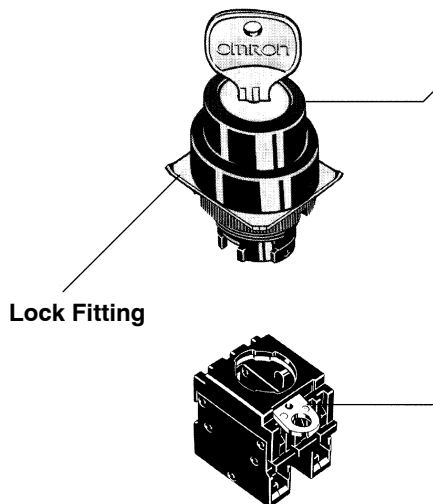

Operational Unit

Number of Positions

- 2 Positions/3 Positions

Key Release Position

2 Positions



3 Positions



Switch Unit

- **Contacts**

SPST-NO, SPST-NC, SPST-NO + SPST-NC, DPST-NO, DPST-NC

■ PART NUMBER LEGEND

Shipped as a set which includes the Operational Unit and Switch Unit with contact blocks.

A22K- ¹- ²

1 Number of Positions/Reset Method

Code	Positions	Reset method	Key release position
2ML	2 positions	Maintained	Left
2M			Left and right
2AL		Spring return	Left
3ML	3 positions	Maintained	Left
3M			Left and right
3MC			Center
3AC		Spring return	Center











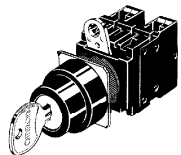

















2 Contacts

Code	Description
10	SPST-NO (*)
01	SPST-NC (*)
11	SPST-NO + SPST-NC
20	DPST-NO
02	DPST-NC

Note: * for models with 2 Positions

Note: SPST= Single Pole, Single Throw
DPST= Double Pole, Single Throw

■ KEY-TYPE SELECTOR SWITCH

Appearance	Positions	Operator type	Contacts	Key release position	Color of Operational Unit	Part number		
Key-type selector switch 	2 positions	Maintained 	SPST-NO		Black	A22K-2ML-10		
						A22K-2M-10		
			SPST-NC			A22K-2ML-01		
						A22K-2M-01		
			SPST-NO + SPST-NC			A22K-2ML-11		
						A22K-2M-11		
			DPST-NO			A22K-2ML-20		
				A22K-2M-20				
		DPST-NC		A22K-2ML-02				
				A22K-2M-02				
		Spring return 				SPST-NO		A22K-2AL-10
						SPST-NC		A22K-2AL-01
						SPST-NO + SPST-NC		A22K-2AL-11
						DPST-NO		A22K-2AL-20
	DPST-NC				A22K-2AL-02			
	3 positions	Maintained 	SPST-NO + SPST-NC		A22K-3ML-11			
					A22K-3M-11			
					A22K-3MC-11			
			DPST-NO		A22K-3ML-20			
					A22K-3M-20			
					A22K-3MC-20			
			DPST-NC		A22K-3ML-02			
				A22K-3M-02				
				A22K-3MC-02				
		A22K-3AC-02						
Spring return 				SPST-NO + SPST-NC		A22K-3AC-11		
				DPST-NO		A22K-3AC-20		
				DPST-NC		A22K-3AC-02		

Dimensions

Unit: mm (inch)

KEY-TYPE SELECTOR SWITCH

A22K

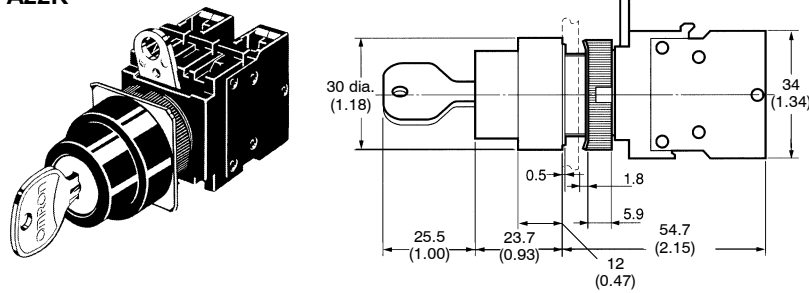

TERMINAL ARRANGEMENT

Terminal Arrangement (Bottom View)

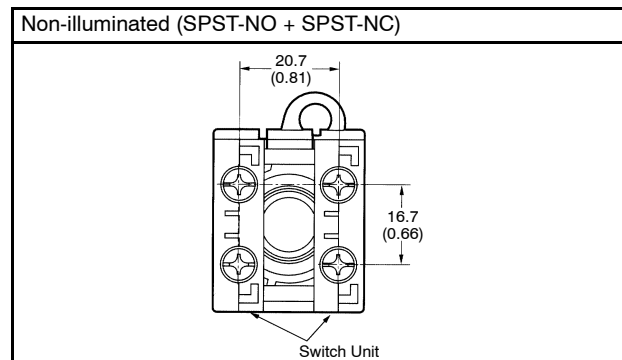

TERMINAL CONNECTION

Type	Terminal connection
Non-illuminated	<p>Bottom view</p>

Note: The above terminal connection diagrams are examples for SPST-NO + SPST-NC.

PANEL CUTOUT DIMENSIONS

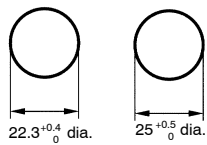

Note: When applying a coating such as paint to a panel, the dimensions should be those after the application of the coating.

A lock fitting is provided as a standard item.

CONTACT CONFIGURATION

2-Position Type

Knob position	SPST-NO	SPST-NC	SPST-NO + SPST-NC	DPST-NO	DPST-NC

3-Position Type

Knob position	SPST-NO + SPST-NC	DPST-NO	DPST-NC

Note: For additional specifications and information refer to the *Common to all assemblies* section at the end of this publication.

NOTE: DIMENSIONS SHOWN ARE IN MILLIMETERS. To convert millimeters to inches divide by 25.4.

OMRON[®]

OMRON ELECTRONICS LLC

One East Commerce Drive
Schaumburg, IL 60173

1-800-55-OMRON

OMRON ON-LINE

Global - <http://www.omron.com>
USA - <http://www.omron.com/oei>
Canada - <http://www.omron.com/oci>

OMRON CANADA, INC.

885 Milner Avenue
Scarborough, Ontario M1B 5V8

416-286-6465