

MC14504B

Hex Level Shifter for TTL to CMOS or CMOS to CMOS

The MC14504B is a hex non-inverting level shifter using CMOS technology. The level shifter will shift a TTL signal to CMOS logic levels for any CMOS supply voltage between 5 and 15 volts. A control input also allows interface from CMOS to CMOS at one logic level to another logic level: Either up or down level translating is accomplished by selection of power supply levels V_{DD} and V_{CC} . The V_{CC} level sets the input signal levels while V_{DD} selects the output voltage levels.

- UP Translates from a Low to a High Voltage or DOWN Translates from a High to a Low Voltage
- Input Threshold Can Be Shifted for TTL Compatibility
- No Sequencing Required on Power Supplies or Inputs for Power Up or Power Down
- 3 to 18 Vdc Operation for V_{DD} and V_{CC}
- Diode Protected Inputs to V_{SS}
- Capable of Driving Two Low-Power TTL Loads or One Low-Power Schottky TTL Load Over the Rated Temperature Range

MAXIMUM RATINGS (Voltages Referenced to V_{SS}) (Note 2.)

Symbol	Parameter	Value	Unit
V_{CC}	DC Supply Voltage Range	-0.5 to +18.0	V
V_{DD}	DC Supply Voltage Range	-0.5 to +18.0	V
V_{in}	Input Voltage Range (DC or Transient)	-0.5 to +18.0	V
V_{out}	Output Voltage Range (DC or Transient)	-0.5 to $V_{DD} + 0.5$	V
I_{in}, I_{out}	Input or Output Current (DC or Transient) per Pin	± 10	mA
P_D	Power Dissipation, per Package (Note 3.)	500	mW
T_A	Ambient Temperature Range	-55 to +125	$^{\circ}C$
T_{stg}	Storage Temperature Range	-65 to +150	$^{\circ}C$
T_L	Lead Temperature (8-Second Soldering)	260	$^{\circ}C$

2. Maximum Ratings are those values beyond which damage to the device may occur.
3. Temperature Derating:
Plastic "P and D/DW" Packages: - 7.0 mW/ $^{\circ}C$ From 65 $^{\circ}C$ To 125 $^{\circ}C$

This device contains protection circuitry to guard against damage due to high static voltages or electric fields. However, precautions must be taken to avoid applications of any voltage higher than maximum rated voltages to this high-impedance circuit. For proper operation, V_{in} and V_{out} should be constrained to the range $V_{SS} \leq (V_{in} \text{ or } V_{out}) \leq V_{DD}$.

Unused inputs must always be tied to an appropriate logic voltage level (e.g., either V_{SS} or V_{DD}). Unused outputs must be left open.



ON Semiconductor

<http://onsemi.com>

MARKING DIAGRAMS

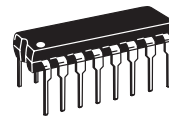

PDIP-16
P SUFFIX
CASE 648

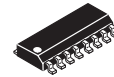
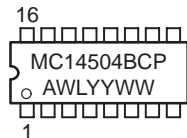

SOIC-16
D SUFFIX
CASE 751B



TSSOP-16
DT SUFFIX
CASE 948F

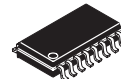
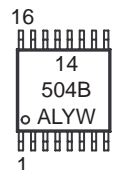

SOEIAJ-16
F SUFFIX
CASE 966

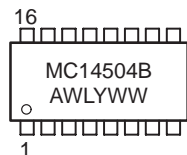

A = Assembly Location
WL or L = Wafer Lot
YY or Y = Year
WW or W = Work Week

ORDERING INFORMATION

Device	Package	Shipping
MC14504BCP	PDIP-16	2000/Box
MC14504BD	SOIC-16	48/Rail
MC14504BDR2	SOIC-16	2500/Tape & Reel
MC14504BDT	TSSOP-16	96/Rail
MC14504BF	SOEIAJ-16	See Note 1.
MC14504BFEL	SOEIAJ-16	See Note 1.

1. For ordering information on the EIAJ version of the SOIC packages, please contact your local ON Semiconductor representative.

MC14504B

PIN ASSIGNMENT

V_{CC}	1	16	V_{DD}
A_{out}	2	15	F_{out}
A_{in}	3	14	F_{in}
B_{out}	4	13	MODE
B_{in}	5	12	E_{out}
C_{out}	6	11	E_{in}
C_{in}	7	10	D_{out}
V_{SS}	8	9	D_{in}

LOGIC DIAGRAM

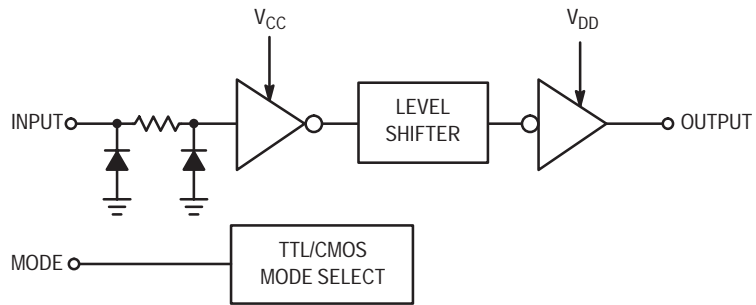

Mode Select	Input Logic Levels	Output Logic Levels
1 (V_{CC})	TTL	CMOS
0 (V_{SS})	CMOS	CMOS

1/6 of package shown.

MC14504B

ELECTRICAL CHARACTERISTICS (Voltages Referenced to V_{SS})

Characteristic	Symbol	V_{CC} Vdc	V_{DD} Vdc	- 55°C		25°C			125°C		Unit	
				Min	Max	Min	Typ (4.)	Max	Min	Max		
Output Voltage $V_{in} = 0\text{ V}$ $V_{in} = V_{CC}$	"0" Level V_{OL}	—	5.0	—	0.05	—	0	0.05	—	0.05	Vdc	
		—	10	—	0.05	—	0	0.05	—	0.05		
		—	15	—	0.05	—	0	0.05	—	0.05		
	"1" Level V_{OH}	—	5.0	4.95	—	4.95	5.0	—	4.95	—		Vdc
		—	10	9.95	—	9.95	10	—	9.95	—		
		—	15	14.95	—	14.95	15	—	14.95	—		
Input Voltage "0" Level ($V_{OL} = 1.0\text{ Vdc}$) TTL-CMOS ($V_{OL} = 1.5\text{ Vdc}$) TTL-CMOS ($V_{OL} = 1.0\text{ Vdc}$) CMOS-CMOS ($V_{OL} = 1.5\text{ Vdc}$) CMOS-CMOS ($V_{OL} = 1.5\text{ Vdc}$) CMOS-CMOS	V_{IL}	5.0	10	—	0.8	—	1.3	0.8	—	0.8	Vdc	
		5.0	15	—	0.8	—	1.3	0.8	—	0.8		
		5.0	10	—	1.5	—	2.25	1.5	—	1.4		
		5.0	15	—	1.5	—	2.25	1.5	—	1.5		
		10	15	—	3.0	—	4.5	3.0	—	2.9		
		—	—	—	—	—	—	—	—	—		—
Input Voltage "1" Level ($V_{OH} = 9.0\text{ Vdc}$) TTL-CMOS ($V_{OH} = 13.5\text{ Vdc}$) TTL-CMOS ($V_{OH} = 9.0\text{ Vdc}$) CMOS-CMOS ($V_{OH} = 13.5\text{ Vdc}$) CMOS-CMOS ($V_{OH} = 13.5\text{ Vdc}$) CMOS-CMOS	V_{IH}	5.0	10	2.0	—	2.0	1.5	—	2.0	—	Vdc	
		5.0	15	2.0	—	2.0	1.5	—	2.0	—		
		5.0	10	3.6	—	3.5	2.75	—	3.5	—		
		5.0	15	3.6	—	3.5	2.75	—	3.5	—		
		10	15	7.1	—	7.0	5.5	—	7.0	—		
		—	—	—	—	—	—	—	—	—		—
Output Drive Current ($V_{OH} = 2.5\text{ Vdc}$) ($V_{OH} = 4.6\text{ Vdc}$) ($V_{OH} = 9.5\text{ Vdc}$) ($V_{OH} = 13.5\text{ Vdc}$) ($V_{OL} = 0.4\text{ Vdc}$) ($V_{OL} = 0.5\text{ Vdc}$) ($V_{OL} = 1.5\text{ Vdc}$)	Source I_{OH}	—	5.0	-3.0	—	-2.4	-4.2	—	-1.7	—	mAdc	
		—	5.0	-0.64	—	-0.51	-0.88	—	-0.36	—		
		—	10	-1.6	—	-1.3	-2.25	—	-0.9	—		
		—	15	-4.2	—	-3.4	-8.8	—	-2.4	—		
	Sink I_{OL}	—	5.0	0.64	—	0.51	0.88	—	0.36	—		mAdc
		—	10	1.6	—	1.3	2.25	—	0.9	—		
—		15	4.2	—	3.4	8.8	—	2.4	—			
Input Current	I_{in}	—	15	—	± 0.1	—	± 0.00001	± 0.1	—	± 1.0	μAdc	
Input Capacitance ($V_{in} = 0$)	C_{in}	—	—	—	—	—	5.0	7.5	—	—	pF	
Quiescent Current (Per Package) CMOS-CMOS Mode	I_{DD} or I_{CC}	—	5.0	—	0.05	—	0.0005	0.05	—	1.5	μAdc	
		—	10	—	0.10	—	0.0010	0.10	—	3.0		
		—	15	—	0.20	—	0.0015	0.20	—	6.0		
Quiescent Current (Per Package) TTL-CMOS Mode	I_{DD}	5.0	5.0	—	0.5	—	0.0005	0.5	—	3.8	μAdc	
		5.0	10	—	1.0	—	0.0010	1.0	—	7.5		
		5.0	15	—	2.0	—	0.0015	2.0	—	15		
Quiescent Current (Per Package) TTL-CMOS Mode	I_{CC}	5.0	5.0	—	5.0	—	2.5	5.0	—	6.0	mAdc	
		5.0	10	—	5.0	—	2.5	5.0	—	6.0		
		5.0	15	—	5.0	—	2.5	5.0	—	6.0		

4. Data labelled "Typ" is not to be used for design purposes but is intended as an indication of the IC's potential performance.

MC14504B

SWITCHING CHARACTERISTICS (C_L = 50 pF, T_A = 25°C)

Characteristic	Symbol	Shifting Mode	V _{CC} Vdc	V _{DD} Vdc	Limits			Unit
					Min	Typ ⁽⁵⁾	Max	
Propagation Delay, High to Low	t _{PHL}	TTL – CMOS V _{DD} > V _{CC}	5.0	10	—	140	280	ns
			5.0	15	—	140	280	
		CMOS – CMOS V _{DD} > V _{CC}	5.0	10	—	120	240	
			5.0	15	—	120	240	
			10	15	—	70	140	
		CMOS – CMOS V _{CC} > V _{DD}	10	5.0	—	185	370	
15	5.0		—	185	370			
15	10		—	175	350			
Propagation Delay, Low to High	t _{PLH}	TTL – CMOS V _{DD} > V _{CC}	5.0	10	—	170	340	ns
			5.0	15	—	160	320	
		CMOS – CMOS V _{DD} > V _{CC}	5.0	10	—	170	340	
			5.0	15	—	170	340	
			10	15	—	100	200	
		CMOS – CMOS V _{CC} > V _{DD}	10	5.0	—	275	550	
15	5.0		—	275	550			
15	10		—	145	290			
Output Rise and Fall Time	t _{TLH} , t _{TFL}	ALL	—	5.0	—	100	200	ns
			—	10	—	50	100	
			—	15	—	40	80	

5. Data labelled "Typ" is not to be used for design purposes but is intended as an indication of the IC's potential performance.

MC14504B

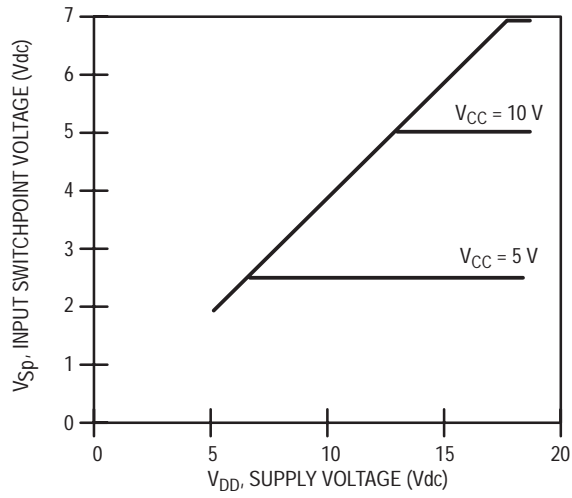

Figure 1. Input Switchpoint CMOS to CMOS Mode

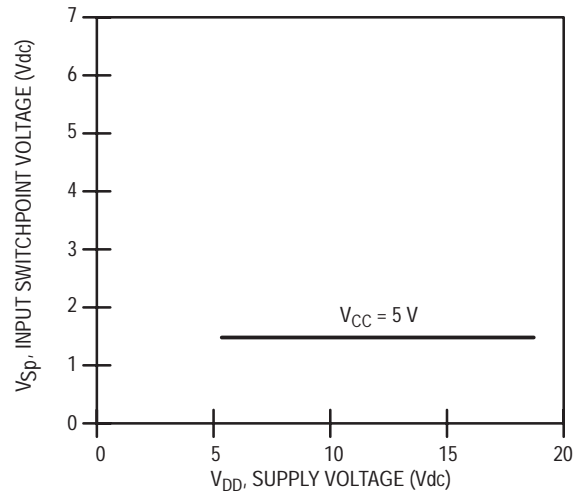

Figure 2. Input Switchpoint TTL to CMOS Mode

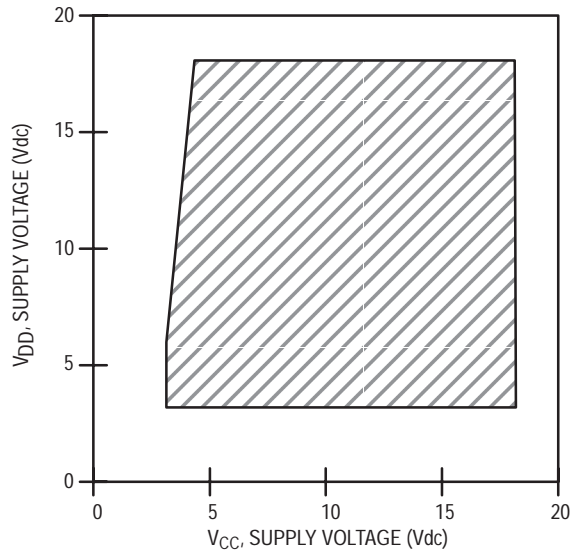

Figure 3. Operating Boundary CMOS to CMOS Mode

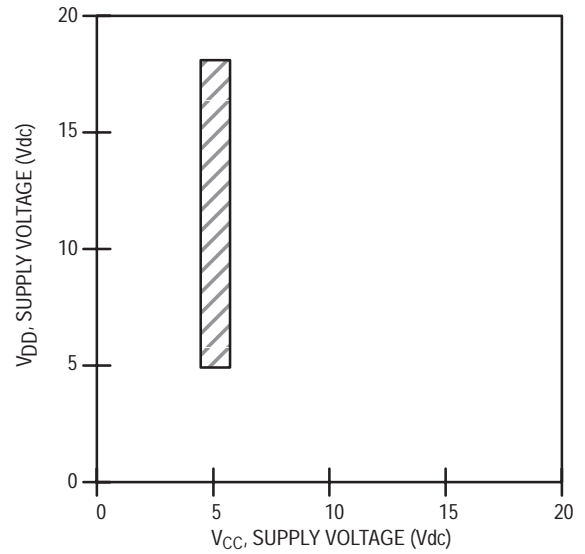

Figure 4. Operating Boundary TTL to CMOS Mode

MC14504B

PACKAGE DIMENSIONS

PDIP-16 P SUFFIX PLASTIC DIP PACKAGE CASE 648-08 ISSUE R



NOTES:

1. DIMENSIONING AND TOLERANCING PER ANSI Y14.5M, 1982.
2. CONTROLLING DIMENSION: INCH.
3. DIMENSION L TO CENTER OF LEADS WHEN FORMED PARALLEL.
4. DIMENSION B DOES NOT INCLUDE MOLD FLASH.
5. ROUNDED CORNERS OPTIONAL.

DIM	INCHES		MILLIMETERS	
	MIN	MAX	MIN	MAX
A	0.740	0.770	18.80	19.55
B	0.250	0.270	6.35	6.85
C	0.145	0.175	3.69	4.44
D	0.015	0.021	0.39	0.53
F	0.040	0.70	1.02	1.77
G	0.100 BSC		2.54 BSC	
H	0.050 BSC		1.27 BSC	
J	0.008	0.015	0.21	0.38
K	0.110	0.130	2.80	3.30
L	0.295	0.305	7.50	7.74
M	0°	10°	0°	10°
S	0.020	0.040	0.51	1.01

SOIC-16 D SUFFIX PLASTIC SOIC PACKAGE CASE 751B-05 ISSUE J

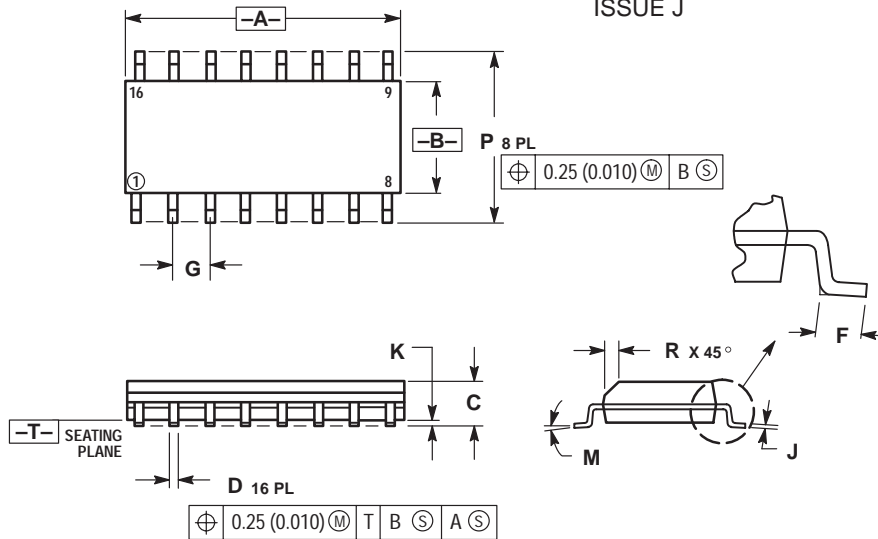

NOTES:

1. DIMENSIONING AND TOLERANCING PER ANSI Y14.5M, 1982.
2. CONTROLLING DIMENSION: MILLIMETER.
3. DIMENSIONS A AND B DO NOT INCLUDE MOLD PROTRUSION.
4. MAXIMUM MOLD PROTRUSION 0.15 (0.006) PER SIDE.
5. DIMENSION D DOES NOT INCLUDE DAMBAR PROTRUSION. ALLOWABLE DAMBAR PROTRUSION SHALL BE 0.127 (0.005) TOTAL IN EXCESS OF THE D DIMENSION AT MAXIMUM MATERIAL CONDITION.

DIM	MILLIMETERS		INCHES	
	MIN	MAX	MIN	MAX
A	9.80	10.00	0.386	0.393
B	3.80	4.00	0.150	0.157
C	1.35	1.75	0.054	0.068
D	0.35	0.49	0.014	0.019
F	0.40	1.25	0.016	0.049
G	1.27 BSC		0.050 BSC	
J	0.19	0.25	0.008	0.009
K	0.10	0.25	0.004	0.009
M	0°	7°	0°	7°
P	5.80	6.20	0.229	0.244
R	0.25	0.50	0.010	0.019

MC14504B

PACKAGE DIMENSIONS

TSSOP-16
DT SUFFIX
PLASTIC TSSOP PACKAGE
CASE 948F-01
ISSUE O

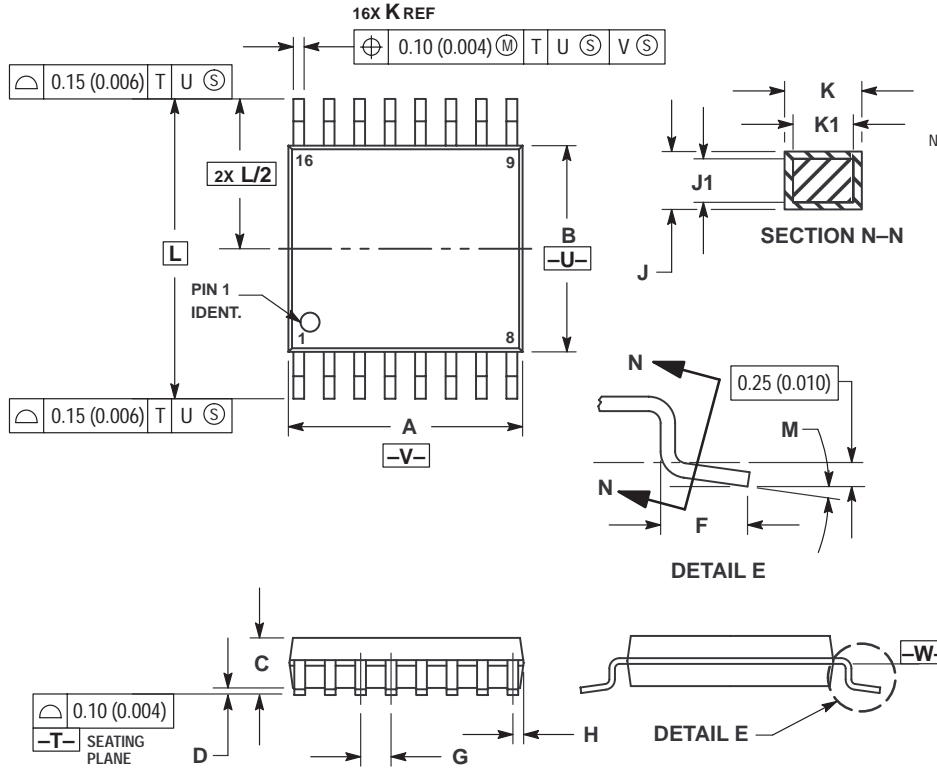

NOTES:

1. DIMENSIONING AND TOLERANCING PER ANSI Y14.5M, 1982.
2. CONTROLLING DIMENSION: MILLIMETER.
3. DIMENSION A DOES NOT INCLUDE MOLD FLASH, PROTRUSIONS OR GATE BURRS. MOLD FLASH OR GATE BURRS SHALL NOT EXCEED 0.15 (0.006) PER SIDE.
4. DIMENSION B DOES NOT INCLUDE INTERLEAD FLASH OR PROTRUSION. INTERLEAD FLASH OR PROTRUSION SHALL NOT EXCEED 0.25 (0.010) PER SIDE.
5. DIMENSION K DOES NOT INCLUDE DAMBAR PROTRUSION. ALLOWABLE DAMBAR PROTRUSION SHALL BE 0.08 (0.003) TOTAL IN EXCESS OF THE K DIMENSION AT MAXIMUM MATERIAL CONDITION.
6. TERMINAL NUMBERS ARE SHOWN FOR REFERENCE ONLY.
7. DIMENSION A AND B ARE TO BE DETERMINED AT DATUM PLANE -W-.

DIM	MILLIMETERS		INCHES	
	MIN	MAX	MIN	MAX
A	4.90	5.10	0.193	0.200
B	4.30	4.50	0.169	0.177
C	---	1.20	---	0.047
D	0.05	0.15	0.002	0.006
F	0.50	0.75	0.020	0.030
G	0.65 BSC		0.026 BSC	
H	0.18	0.28	0.007	0.011
J	0.09	0.20	0.004	0.008
J1	0.09	0.16	0.004	0.006
K	0.19	0.30	0.007	0.012
K1	0.19	0.25	0.007	0.010
L	6.40 BSC		0.252 BSC	
M	0°	8°	0°	8°

MC14504B

PACKAGE DIMENSIONS

SOEIAJ-16 F SUFFIX PLASTIC EIAJ SOIC PACKAGE CASE 966-01 ISSUE O

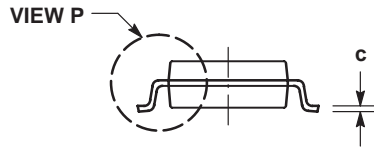
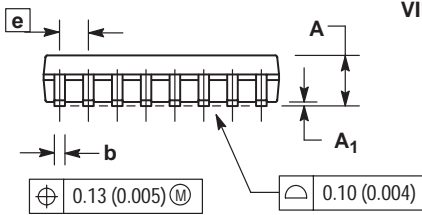
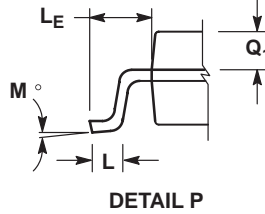
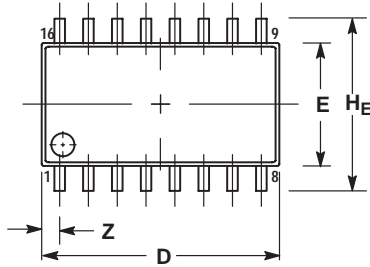

NOTES:

1. DIMENSIONING AND TOLERANCING PER ANSI Y14.5M, 1982.
2. CONTROLLING DIMENSION: MILLIMETER.
3. DIMENSIONS D AND E DO NOT INCLUDE MOLD FLASH OR PROTRUSIONS AND ARE MEASURED AT THE PARTING LINE. MOLD FLASH OR PROTRUSIONS SHALL NOT EXCEED 0.15 (0.006) PER SIDE.
4. TERMINAL NUMBERS ARE SHOWN FOR REFERENCE ONLY.
5. THE LEAD WIDTH DIMENSION (b) DOES NOT INCLUDE DAMBAR PROTRUSION. ALLOWABLE DAMBAR PROTRUSION SHALL BE 0.08 (0.003) TOTAL IN EXCESS OF THE LEAD WIDTH DIMENSION AT MAXIMUM MATERIAL CONDITION. DAMBAR CANNOT BE LOCATED ON THE LOWER RADIUS OR THE FOOT. MINIMUM SPACE BETWEEN PROTRUSIONS AND ADJACENT LEAD TO BE 0.46 (0.018).

DIM	MILLIMETERS		INCHES	
	MIN	MAX	MIN	MAX
A	---	2.05	---	0.081
A ₁	0.05	0.20	0.002	0.008
b	0.35	0.50	0.014	0.020
c	0.18	0.27	0.007	0.011
D	9.90	10.50	0.390	0.413
E	5.10	5.45	0.201	0.215
e	1.27 BSC		0.050 BSC	
H _E	7.40	8.20	0.291	0.323
L	0.50	0.85	0.020	0.033
L _F	1.10	1.50	0.043	0.059
M	0°	10°	0°	10°
Q ₁	0.70	0.90	0.028	0.035
Z	---	0.78	---	0.031

ON Semiconductor and  are trademarks of Semiconductor Components Industries, LLC (SCILLC). SCILLC reserves the right to make changes without further notice to any products herein. SCILLC makes no warranty, representation or guarantee regarding the suitability of its products for any particular purpose, nor does SCILLC assume any liability arising out of the application or use of any product or circuit, and specifically disclaims any and all liability, including without limitation special, consequential or incidental damages. "Typical" parameters which may be provided in SCILLC data sheets and/or specifications can and do vary in different applications and actual performance may vary over time. All operating parameters, including "Typicals" must be validated for each customer application by customer's technical experts. SCILLC does not convey any license under its patent rights nor the rights of others. SCILLC products are not designed, intended, or authorized for use as components in systems intended for surgical implant into the body, or other applications intended to support or sustain life, or for any other application in which the failure of the SCILLC product could create a situation where personal injury or death may occur. Should Buyer purchase or use SCILLC products for any such unintended or unauthorized application, Buyer shall indemnify and hold SCILLC and its officers, employees, subsidiaries, affiliates, and distributors harmless against all claims, costs, damages, and expenses, and reasonable attorney fees arising out of, directly or indirectly, any claim of personal injury or death associated with such unintended or unauthorized use, even if such claim alleges that SCILLC was negligent regarding the design or manufacture of the part. SCILLC is an Equal Opportunity/Affirmative Action Employer.

PUBLICATION ORDERING INFORMATION

NORTH AMERICA Literature Fulfillment:

Literature Distribution Center for ON Semiconductor
P.O. Box 5163, Denver, Colorado 80217 USA
Phone: 303-675-2175 or 800-344-3860 Toll Free USA/Canada
Fax: 303-675-2176 or 800-344-3867 Toll Free USA/Canada
Email: ONlit@hibbertco.com
Fax Response Line: 303-675-2167 or 800-344-3810 Toll Free USA/Canada

N. American Technical Support: 800-282-9855 Toll Free USA/Canada

EUROPE: LDC for ON Semiconductor – European Support

German Phone: (+1) 303-308-7140 (M-F 1:00pm to 5:00pm Munich Time)
Email: ONlit-german@hibbertco.com
French Phone: (+1) 303-308-7141 (M-F 1:00pm to 5:00pm Toulouse Time)
Email: ONlit-french@hibbertco.com
English Phone: (+1) 303-308-7142 (M-F 12:00pm to 5:00pm UK Time)
Email: ONlit@hibbertco.com

EUROPEAN TOLL-FREE ACCESS*: 00-800-4422-3781

*Available from Germany, France, Italy, England, Ireland

CENTRAL/SOUTH AMERICA:

Spanish Phone: 303-308-7143 (Mon-Fri 8:00am to 5:00pm MST)
Email: ONlit-spanish@hibbertco.com

ASIA/PACIFIC: LDC for ON Semiconductor – Asia Support

Phone: 303-675-2121 (Tue-Fri 9:00am to 1:00pm, Hong Kong Time)
Toll Free from Hong Kong & Singapore:
001-800-4422-3781
Email: ONlit-asia@hibbertco.com

JAPAN: ON Semiconductor, Japan Customer Focus Center

4-32-1 Nishi-Gotanda, Shinagawa-ku, Tokyo, Japan 141-8549
Phone: 81-3-5740-2745
Email: r14525@onsemi.com

ON Semiconductor Website: <http://onsemi.com>

For additional information, please contact your local Sales Representative.

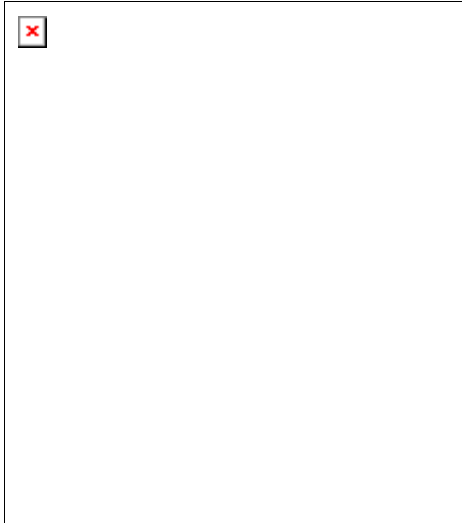

- [Press Room](#)
- [Sales & Distribution](#)
- [About Us](#)
- [Quality](#)
- [Trade Shows](#)
- [Investor Relations](#)
- [Employment](#)
- [Products](#)

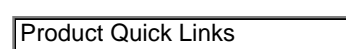

Associated Documents

Item	Short Desc
Data Sheet	Hex Level Shifter for TTL to CMOS or CMOS to CMOS



- [Product Catalog](#)
- [New Products](#)
- [ON/Cherry Products](#)
- [Documentation](#)
- [Selector Guide](#)
- [On-line Ordering](#)
- [Models](#)
- [Reliability Data](#)
- [PCN](#)
- [Samples Search](#)
- [Order Status](#)
- [Tech Support](#)

Device MC14504B
Hex Level Shifter

The MC14504B is a hex non-inverting level shifter using CMOS technology. The IC translates TTL signal to CMOS logic levels for any CMOS supply voltage between 5 and 15 v. It allows interface from CMOS to CMOS at one logic level to another logic level. Either translating is accomplished by selection of power supply levels V_{DD} and V_{CC} . The input signal levels while V_{DD} selects the output voltage levels.

Features:

- UP Translates from a Low to a High Voltage or DOWN Translates from a High to a Low Voltage
- Input Threshold Can Be Shifted for TTL Compatibility
- No Sequencing Required on Power Supplies or Inputs for Power Up or Power Down
- 3 to 18 Vdc Operation for V_{DD} and V_{CC}
- Diode Protected Inputs to V_{SS}
- Capable of Driving Two Low-Power TTL Loads or One Low-Power Schottky TTL Load Over the Rated Temperature Range

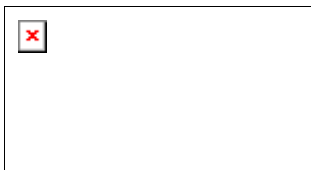

Orderable Parts

	Short	Package	Pin	Case

Action	Orderable Part	Part Desc.	Package Desc.	Part Count	Part Outline	Status
N/A	MC14504BFEL	Tape and Reel	MFP	16	966-01	Active
N/A	MC14504BFL1	Tape and Reel	MFP	16	966-01	LifeTime
N/A	MC14504BFR1	Tape and Reel	MFP	16	966-01	LifeTime
N/A	MC14504BCP	CMOS Hex Level Shifter	PDIP	16	648-08	Active
N/A	MC14504BD	CMOS Hex Level Shifter	SOIC	16	751B-05	Active
N/A	MC14504BDR2	Tape and Reel	SOIC	16	751B-05	Active
N/A	MC14504BDT	CMOS Hex Level Shifter	TSSOP	16	948F-01	Active
N/A	MC14504BF	CMOS Hex Level Shifter	MFP	16	966-01	Active
N/A	MC14504BFR2	Tape and Reel	MFP	16	966-01	LifeTime

[Register](#) | [Site Index](#) | [Contact Us](#) | [Home](#) | [China Site](#)

[Products](#) | [Press Room](#) | [Sales](#) | [About](#) | [Investor](#) | [Employment](#)

© Semiconductor Components Industries, L.L.C., 1999, 2000. All rights reserved. [Terms of use.](#)