



# EVK-G45

## SARA-G450 cellular evaluation kit

### User guide



#### Abstract

This guide explains how to set up the EVK-G45 evaluation kit to begin evaluating the u-blox SARA-G450 GSM/GPRS cellular modules.

# Document information

<b>Title</b>	<b>EVK-G45</b>		
<b>Subtitle</b>	SARA-G450 cellular evaluation kit		
<b>Document type</b>	User guide		
<b>Document number</b>	UBX-18058360		
<b>Revision and date</b>	R06	08-Mar-2021	
<b>Disclosure restriction</b>	C1-Public		

This document applies to the following products:

Product name	Type number	Modem version	Application version	PCN reference	Product status
EVK-G45	EVK-G45-0-00	09.02	A05.01	UBX-21006193	Mass production

u-blox or third parties may hold intellectual property rights in the products, names, logos and designs included in this document. Copying, reproduction, modification or disclosure to third parties of this document or any part thereof is only permitted with the express written permission of u-blox.

The information contained herein is provided "as is" and u-blox assumes no liability for its use. No warranty, either express or implied, is given, including but not limited to, with respect to the accuracy, correctness, reliability and fitness for a particular purpose of the information. This document may be revised by u-blox at any time without notice. For the most recent documents, visit [www.u-blox.com](http://www.u-blox.com).

Copyright © u-blox AG.

# Contents

<b>Document information</b> .....	<b>2</b>
<b>Contents</b> .....	<b>3</b>
<b>1 Starting up</b> .....	<b>4</b>
1.1 EVK-G45 overview.....	4
1.2 EVK-G45 block diagram.....	5
1.3 Switches, jumpers and buttons .....	6
1.4 LEDs.....	7
1.5 Connectors .....	8
1.6 EVK-G45 pin out.....	9
1.6.1 Routing of SARA-G450 module pins to connectors on the ADP-G45.....	9
1.6.2 Pin-out of the 42-pin dual in-line board-to-board connectors on the ADP-G450.....	10
1.7 Software installation .....	10
1.8 Board setup .....	11
1.9 Enabling error result codes .....	12
1.10 PIN code insertion (when required).....	12
1.11 Registration on a cellular network .....	12
1.12 Switching off the EVK-G45.....	12
<b>Appendix</b> .....	<b>13</b>
<b>A Set up AT terminal applications for communication with the EVK-G45</b> .....	<b>13</b>
<b>B Set up cellular packet data connection on PC</b> .....	<b>14</b>
B.1 Install a new modem from the control panel.....	14
B.2 Configuring a new connection .....	15
<b>C Examples of AT commands</b> .....	<b>16</b>
C.1 Voice call .....	16
C.2 SMS management.....	17
C.3 Internet connection in GPRS mode (external TCP/IP stack) .....	17
C.4 Internet connection in GPRS mode (internal TCP/IP stack).....	17
C.5 Enable communication between cellular and GNSS module .....	18
C.6 Read NMEA messages (example: GLL) .....	18
C.7 GNSS AssistNow.....	18
<b>D Current consumption measurement</b> .....	<b>19</b>
<b>E Declaration of conformities</b> .....	<b>20</b>
<b>F Glossary</b> .....	<b>21</b>
<b>Related documentation</b> .....	<b>22</b>
<b>Revision history</b> .....	<b>22</b>
<b>Contact</b> .....	<b>23</b>

# 1 Starting up

## 1.1 EVK-G45 overview

The EVK-G45 kit is a powerful and easy-to-use tool that simplifies evaluation of u-blox SARA-G450 GSM/GPRS modules.

This section describes the main connections and settings required to get started.

See the SARA-G4 series data sheet [3] and the SARA-G4 series system integration manual [4] for the features supported by the u-blox SARA-G4 series cellular modules.

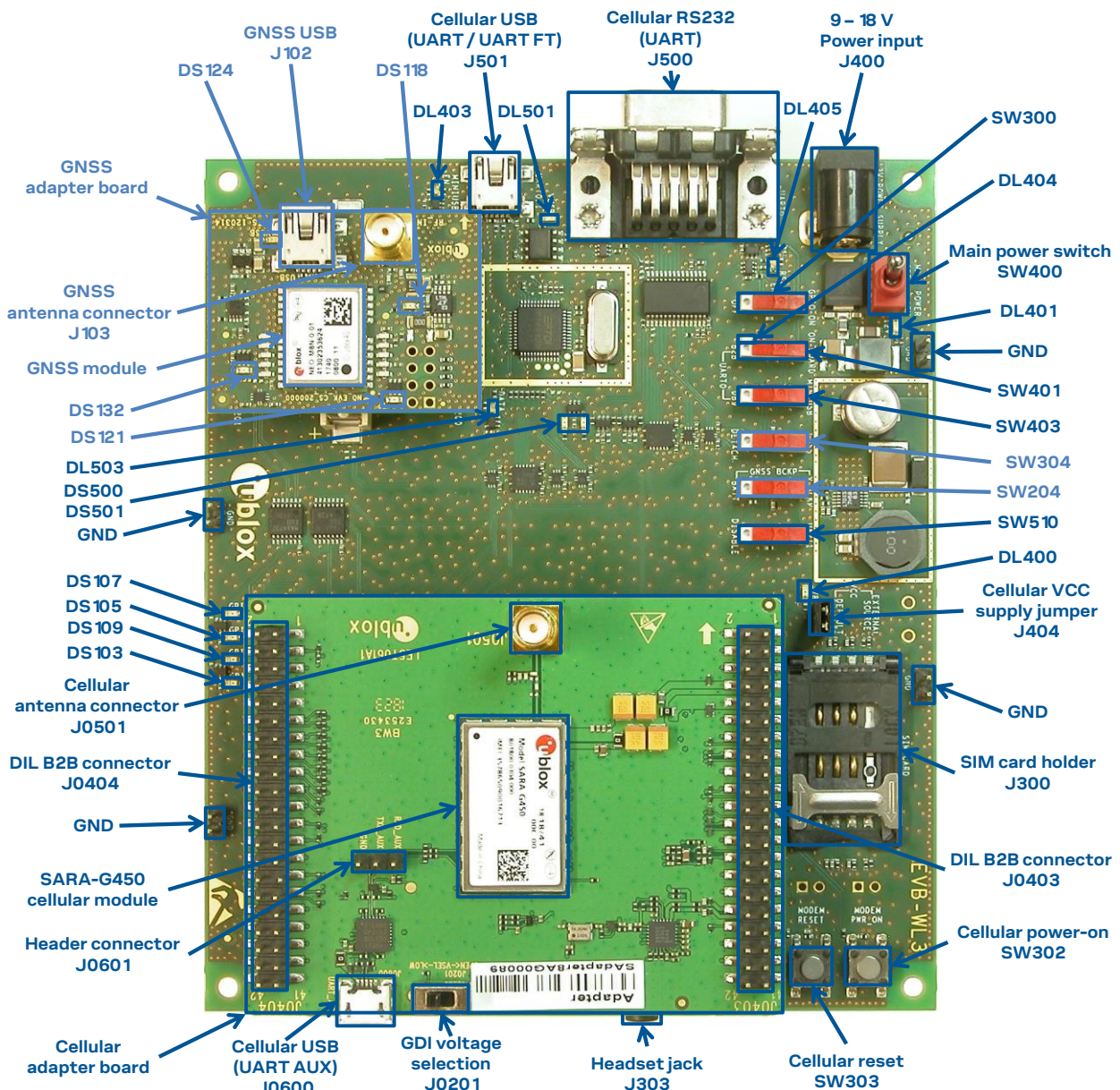

Figure 1: Overview of the EVK-G45 evaluation kit for SARA-G450 modules

## 1.2 EVK-G45 block diagram

Figure 2 shows the main interfaces and internal connections of the EVK-G45 evaluation kit:

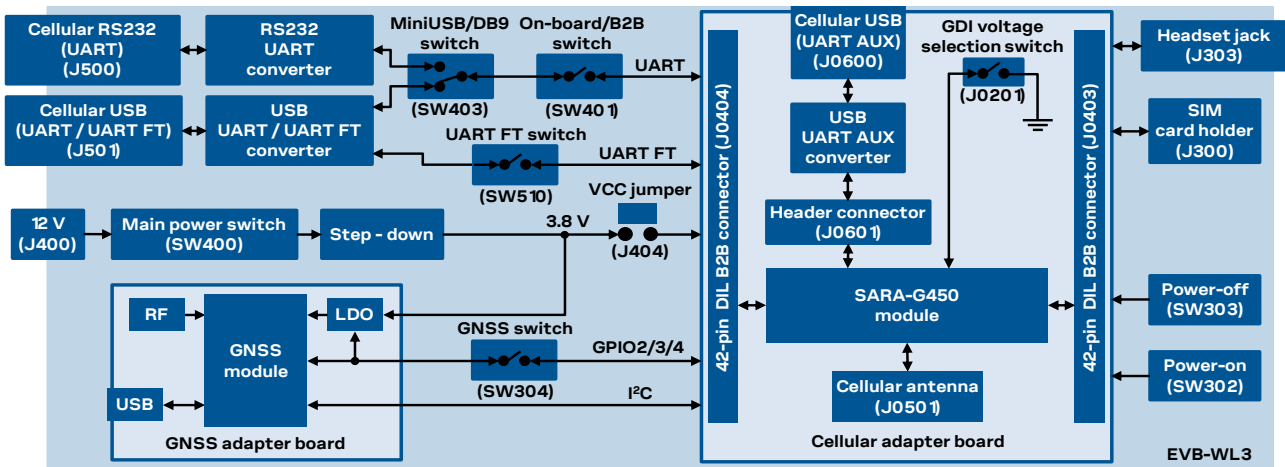

Figure 2: Block diagram of EVK-G45

The EVK-G45 is formed by three boards:

- The lower one, called EVB-WL3, contains the power supply and other peripherals for the SARA-G450 cellular module (as SIM card holder, headset jack, power-off button and power-on button).
- The cellular adapter board, called ADP-G450, contains the SARA-G450 cellular module, the cellular antenna connector, a switch for the digital I/O interfaces (GDI) voltage selection, and a USB connector for the AUX UART interface.
- The GNSS adapter board, called ADP-GNSS, contains the u-blox GNSS module, the LDO supply regulator, the GNSS antenna connector, and the USB connector for the GNSS module.

The boards are connected by means of male header board-to-board connectors provided on the bottom of the adapter board and their corresponding female connectors provided on top of the lower board.

The cellular module's interfaces are available on the dual in-line male board-to-board connectors provided on the top layer of the cellular adapter board (J0403 / J0404), which are pin-to-pin compatible to the connectors on the bottom layer of the adapter board.















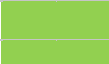
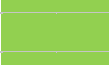

The lower board (EVB-WL3) is designed also to be used with other u-blox cellular adapter boards. It contains additional switches, jumpers, connectors, LEDs and parts that are only partially described in Figure 1 or in this document, because they are intended for use only with other u-blox cellular modules. It is recommended to leave any additional connector unconnected, and to leave any additional switch in its default configuration.

## 1.3 Switches, jumpers and buttons

Function	Description	Name	Board
Main power switch	Power on / off of the whole evaluation kit	SW400	EVB
Cellular VCC jumper	Jumper socket to provide the 3.8 V supply to the cellular module VCC input	J404	EVB
Cellular power-on	Push button to switch on the cellular module	SW302	EVB
Cellular power-off	Push button to switch off the cellular module ("modem reset")	SW303	EVB
Cellular UART detach	Slide switch to attach / detach cellular module UART from the USB / RS232 connectors: when detached, UART signals available only on the DIL B2B connector on the ADP board	SW401	EVB
Cellular UART routing	Slide switch to select cellular module UART routing on the USB or on the RS232 connector	SW403	EVB
Cellular FT UART detach	Slide switch to attach / detach cellular module FT UART from the USB connector: when detached, FT UART signals available only on the DIL B2B connector on the ADP board	SW510	EVB
Cellular GPIO detach	Slide switch to attach / detach the cellular module GPIOs, SIM_DET from peripherals: when detached, the signals are available only on the DIL B2B connector on the ADP board	SW300	EVB
Cellular GNSS detach	Slide switch to attach / detach the cellular module to the GNSS module (GPIO2-3-4): when detached, the signals are available only on DIL B2B connector on the ADP board	SW304	EVB
GNSS V_BCKP	Slide switch to connect / disconnect backup battery to V_BCKP pin of the GNSS module	SW204	EVB
Cellular GDI voltage selection	Slide switch to select operating voltage for cellular Generic Digital I/O Interfaces: 1.8 V / 3.0 V	J0201	ADP-G450

**Table 1: Description of EVK-G45 switches and buttons**

## 1.4 LEDs



Function	Description	LED #	Board	Color
Main power	Power supply plugged in the <b>9 - 18 V power input</b>	DL401	EVB	
Cellular VCC	Cellular module supplied. <b>Main power switch</b> must be switched on	DL400	EVB	
Cellular USB (UART / FT UART)	USB cable plugged into the <b>Cellular USB</b> connector for UART / FT UART access	DL501	EVB	
Cellular USB / UART	Green light is activated when the UART is routed to the <b>Cellular USB</b> connector Red light blinks at UART TX or RX data on the <b>Cellular USB</b> connector	DL403	EVB	
Cellular UART detach	UART signals are available only on the DIL B2B connector on the ADP board	DL404	EVB	
Cellular RS232 / UART	Green light is activated when UART is routed to the <b>Cellular RS232</b> connector Red light blinks at UART TX or RX data on the <b>Cellular RS232</b> connector	DL405	EVB	
Cellular USB / FT UART	Green light is activated when FT UART is routed to the <b>Cellular USB</b> connector Red light blinks at FT UART TX or RX data on the <b>Cellular USB</b> connector	DL503	EVB	
Cellular RI indicator	RI line turns ON (active low)	DS501	EVB	
Cellular CTS indicator	CTS line turns ON (active low)	DS500	EVB	
Cellular GPIO1 indicator	Green light is activated when cellular GPIO1 is high	DS107	EVB	
Cellular GPIO2 indicator	Green light is activated when cellular GPIO2 is high	DS105	EVB	
Cellular GPIO3 indicator	Green light is activated when cellular GPIO3 is high	DS109	EVB	
Cellular GPIO4 indicator	Green light is activated when cellular GPIO4 is high	DS103	EVB	
GNSS VCC supply	GNSS module supply is turned ON	DS118	ADP-GNSS	
GNSS USB	USB cable plugged in <b>GNSS USB</b> connector	DS124	ADP-GNSS	
GNSS Timepulse	Pulses at 1 Hz when valid GNSS fix	DS121	ADP-GNSS	
Cellular / GNSS DDC	Cellular / GNSS module communication over DDC (I <sup>2</sup> C) interface	DS132	ADP-GNSS	

**Table 2: Description of EVK-G45 LEDs**

## 1.5 Connectors

Function	Description	Name	Board
9 - 18 V power input	Connector for the AC / DC power adapter of the EVK AC: 100-240 V, 0.8 A, 50-60 Hz / DC: +12 V, 2.5 A 	J400	EVB
SIM card holder	SIM card holder	J300	EVB
Cellular antenna	SMA connector for the cellular module antenna	J0501	ADP-G450
Cellular USB (AUX UART)	Micro USB 2.0 type B connector for the cellular module AUX UART interface converted as USB interface	J0600	ADP-G450
Cellular USB (UART / FT UART)	Mini USB 2.0 type B connector for the cellular module UART and FT UART interfaces converted as USB interface	J501	EVB
Cellular RS232 (UART)	DB9 connector for the cellular module UART interface converted as an RS232 interface	J500	EVB
DIL B2B headers	Dual in-line board-to-board connectors for the cellular module interfaces	J0403, J0404	ADP-G450
Header connector	Header connector for the cellular module AUX UART interface	J0601	ADP-G450
Cellular headset	Audio headset jack connector for the cellular module audio interface	J303	EVB
GNSS antenna	SMA connector for the GNSS module antenna (GNSS Antenna)	J103	ADP-GNSS
GNSS USB	Mini USB connector for the GNSS module USB interface	J102	ADP-GNSS
GNSS backup battery	Backup battery socket for the GNSS module (under the GNSS adapter board)	BT200	EVB
GND	Ground terminals for the probe reference	J402, J403 J405, J406	EVB

**Table 3: Description of EVK-G45 connectors**

-  CAUTION! IN THE UNLIKELY EVENT OF A FAILURE IN THE INTERNAL PROTECTION CIRCUITRY, THERE IS A RISK OF AN EXPLOSION WHEN CHARGING A FULLY OR PARTIALLY DISCHARGED BATTERY. REPLACE THE BATTERY WHEN IT NO LONGER HAS A SUFFICIENT CHARGE FOR UNIT OPERATION. CONTROL THE BATTERY BEFORE USE IF THE DEVICE HAS NOT BEEN USED FOR AN EXTENDED PERIOD OF TIME.
-  CAUTION! RISK OF EXPLOSION IF BATTERY IS REPLACED WITH AN INCORRECT TYPE. DISPOSE OF USED BATTERIES ACCORDING TO THE INSTRUCTIONS!



## 1.6 EVK-G45 pin out

### 1.6.1 Routing of SARA-G450 module pins to connectors on the ADP-G45

Connector Name/Pin number	SARA-G450 Signal name	SARA-G450 Pin N°	SARA-G450 Pin N°	SARA-G450 Signal name	Connector Name/Pin number
J0404 Pins 7-8-9-10	GND	1	64	GND	J0404 Pins 7-8-9-10
J0404 Pin 3	V_BCKP	2	63	GND	J0404 Pins 7-8-9-10
J0404 Pins 7-8-9-10	GND	3	62	ANT_DET	Not available
J0404 Pin 36	V_INT	4	61	GND	J0404 Pins 7-8-9-10
J0404 Pins 7-8-9-10	GND	5	60	GND	J0404 Pins 7-8-9-10
J0404 Pin 18	DSR	6	59	GND	J0404 Pins 7-8-9-10
J0404 Pin 17	RI	7	58	GND	J0404 Pins 7-8-9-10
J0404 Pin 11	DCD	8	57	GND	J0404 Pins 7-8-9-10
J0404 Pin 12	DTR	9	56	ANT	Not available
J0404 Pin 13	RTS	10	55	GND	J0404 Pins 7-8-9-10
J0404 Pin 14	CTS	11	54	GND	J0404 Pins 7-8-9-10
J0404 Pin 15	TXD	12	53	VCC	J0403 Pins 7-8-9-10
J0404 Pin 16	RXD	13	52	VCC	J0403 Pins 7-8-9-10
J0404 Pins 7-8-9-10	GND	14	51	VCC	J0403 Pins 7-8-9-10
J0404 Pin 29	PWR_ON	15	50	GND	J0404 Pins 7-8-9-10
J0404 Pin 33	GPIO1	16	49	MIC_P	J0403 Pin 28
J0601 Pin 2	TXD_AUX	17	48	MIC_N	Not available
J0403 Pin 26	PWR_OFF	18	47	MIC_GND	J0403 Pin 27
J0601 Pin 1	RXD_AUX	19	46	MIC_BIAS	Not available
J0404 Pins 7-8-9-10	GND	20	45	SPK_N	J0403 Pin 34
Not available	VSEL	21	44	SPK_P	J0403 Pin 33
J0404 Pins 7-8-9-10	GND	22	43	GND	J0404 Pins 7-8-9-10
J0404 Pin 31	GPIO2	23	42	SIM_DET	J0404 Pin 23
J0404 Pin 32	GPIO3	24	41	VSIM	J0403 Pin 13
J0404 Pin 25	GPIO4	25	40	SIM_RST	J0403 Pin 16
J0403 Pin 21	SDA	26	39	SIM_IO	J0403 Pin 14
J0403 Pin 20	SCL	27	38	SIM_CLK	J0403 Pin 15
J0404 Pin 20	RXD_FT	28	37	I2S_RXD	J0403 Pin 23
J0404 Pin 19	TXD_FT	29	36	I2S_CLK	J0403 Pin 22
J0404 Pins 7-8-9-10	GND	30	35	I2S_TXD	J0403 Pin 24
Not available	RSVD	31	34	I2S_WA	J0403 Pin 25
J0404 Pins 7-8-9-10	GND	32	33	RSVD	Not available

**Table 4: Interfaces of SARA-G450 module, as routed up to the 42-pin dual in-line board-to-board connectors (J0403, J0404) and up to other connectors available on the adapter board ADP-G450 of the EVK-G45 evaluation kit**

 The pins / interfaces that are not supported by a specific SARA-G450 module product version should not be driven by an external device (see the SARA-G4 series data sheet [3] and the SARA-G4 series system integration manual [4] for the features supported by each SARA-G450 module product version).

## 1.6.2 Pin-out of the 42-pin dual in-line board-to-board connectors on the ADP-G450

DIL B2B J0404				DIL B2B J0403			
Signal name	Pin N°	Pin N°	Signal name	Signal name	Pin N°	Pin N°	Signal name
Not connected	2	1	GND	Not connected	2	1	GND
Not connected	4	3	V_BCKP	Not connected	4	3	Not connected
Not connected	6	5	Not connected	Not connected	6	5	Not connected
GND	8	7	GND	VCC	8	7	VCC
GND	10	9	GND	VCC	10	9	VCC
DTR	12	11	DCD	Not connected	12	11	Not connected
CTS	14	13	RTS	SIM_IO	14	13	VSIM
RXD	16	15	TXD	SIM_RST	16	15	SIM_CLK
DSR	18	17	RI	Not connected	18	17	Not connected
RXD_FT	20	19	TXD_FT	SCL	20	19	Not connected
Not connected	22	21	Not connected	I2S_CLK	22	21	SDA
Not connected	24	23	SIM_DET	I2S_TXD	24	23	I2S_RXD
Not connected	26	25	GPIO4	PWR_OFF	26	25	I2S_WA
Not connected	28	27	Not connected	MIC_P_BIAS <sup>1</sup>	28	27	MIC_GND
Not connected	30	29	PWR_ON	Not connected	30	29	Not connected
GPIO3	32	31	GPIO2	Not connected	32	31	Not connected
Not connected	34	33	GPIO1	SPK_N	34	33	SPK_P
V_INT	36	35	Not connected	Not connected	36	35	Not connected
Not connected	38	37	Not connected	Not connected	38	37	Not connected
Not connected	40	39	Not connected	Not connected	40	39	Not connected
GND	42	41	GND	GND	42	41	Not connected

**Table 5: Pin-out of the 42-pin dual in-line board-to-board connectors (J201, J200) available on the adapter board ADP-G450**

 The pins / interfaces that are not supported by a specific SARA-G450 module product version should not be driven by an external device (see the SARA-G4 series data sheet [3] and SARA-G4 series system integration manual [4] for the features supported by each SARA-G450 module product version).

## 1.7 Software installation

The USB drivers are available with the EVK-G45. Executable files can be downloaded from [www.u-blox.com/evk-search](http://www.u-blox.com/evk-search) and saved to any location on the computer hard drive. The installation can be started by running the executable file on a computer with the Windows operating system.

<sup>1</sup> Signal and bias line for an external electret microphone: biasing bridge circuit mounted on ADP-G450

## 1.8 Board setup

1. Insert a SIM card into the **SIM card holder** (J300 on the EVB).
2. Connect the cellular antenna provided with the evaluation kit box to the **Cellular antenna SMA** connector on the ADP-G450 (J0501, RF input/output for transmission and reception of 2G RF signals)
3. If the GNSS functionality is required, connect the GNSS antenna provided with the evaluation kit box to the **GNSS antenna SMA** connector on the ADP-GNSS. Place the antenna in a location with a good view of the sky.
4. Connect the AC/DC +12 V power adapter provided with the evaluation kit box to the **9 – 18 V power input** connector (J400 on the EVB). LED DL401 lights blue.
5. Be sure to provide a jumper socket on the **Cellular VCC supply jumper** (J404 on the EVB). This provides the connection from the 3.8 V output of the supply circuit on the EVB to the VCC input of the module.
6. To enable the board power supply, turn the **Main power switch** (SW400 on the EVB) to the ON position. LED DL400 lights green.
7. To switch on the cellular module, press the **Cellular power-on** button (SW302 on EVB).
8. For communication via UART interface of the cellular module, the following connections are allowed and can be alternatively enabled in a mutually exclusive way (see [Table 6](#) for switch position and LED status):
  - 8.1. Connect a USB cable to mini USB connector (**Cellular USB**, J501 on EVB), LED DL501 lights blue
  - 8.2. Connect an RS232 cable to DB9 connector (**Cellular RS232**, J500 on EVB)

Type of connections	SW401	SW403	LED
Access to cellular UART over the <b>Cellular USB</b> (UART / FT UART) mini USB connector (J501)	ON BOARD	MINIUSB	DL403
Access to cellular UART over the <b>Cellular RS232</b> (UART) DB9 connector (J500)	ON BOARD	DB9	DL405
Access to cellular UART on DIL board-to-board connector on the adapter board: cellular UART detached from USB (UART) J501 and RS232 (UART) J500 connectors	B2B	Do not care	DL404

**Table 6: Serial interface configuration**

Using the Cellular USB connector (case 8.1), two COM ports are enabled with Windows (the numbering of the COM ports can be seen via the Windows Device Manager):

- SARA UART (by default for AT commands and data) is available over the first COM port
  - SARA FT UART (by default for FW update and diagnostic) is available over the second COM port
9. Run an AT terminal application (e.g. the u-blox m-center tool) selecting an AT port, with these settings:
    - Data rate: 115'200 bit/s
    - Data bits: 8
    - Parity: none
    - Stop bits: 1
    - Flow control: hardware
 See [Appendix A](#) for how to configure the u-blox m-center AT terminal for Windows.
  10. If the audio functionality is required, connect the headset provided with the evaluation kit box to the **Headset jack** connector (J303 on EVB).

## 1.9 Enabling error result codes

Command sent by DTE (user)	DCE response (module)	Description
AT+CMEE=2	OK	Enables the cellular module to report verbose error result codes.

## 1.10 PIN code insertion (when required)

Command sent by DTE (user)	DCE response (module)	Description
AT+CPIN="8180"	OK	Enter the PIN code, if needed (enter the PIN of the SIM card – 8180 is written here as an example).
AT+CLCK="SC", 0, "8180"	OK	Unlock the PIN at power-on (the last parameter is the PIN of the SIM card – 8180 is written here as an example).
AT+CLCK="SC", 1, "8180"	OK	Lock the PIN at power-on (the last parameter is the PIN of the SIM card – 8180 is written here as an example).

## 1.11 Registration on a cellular network

Command sent by DTE (user)	DCE response (module)	Description
AT+CREG?	+CREG: 0,1 OK	Verify the network registration.
AT+COPS=0	OK	Register the module on the network. The cellular module automatically registers itself on the cellular network. This command is necessary only if the automatic registration failed (AT+CREG? returns 0,0).
AT+COPS?	+COPS: 0,0,"I TIM" OK	Read the operator name.

## 1.12 Switching off the EVK-G45

To switch off the EVK-G45, send the +CPWROFF AT command. Make sure to use this command before switching off the main power, otherwise settings and configuration parameters may not be saved in the internal non-volatile memory of the cellular module.

# Appendix

## A Set up AT terminal applications for communication with the EVK-G45

The u-blox m-center cellular module evaluation tool is a powerful platform for evaluating, configuring and testing u-blox cellular products. m-center includes an AT commands terminal for communication with the device and can be downloaded free-of-charge from our website (<http://www.u-blox.com>).

1. Follow the board setup instructions in section 1.8 to provide all the required connections and switching on the cellular module.
2. Run the m-center tool: after the m-center start-up, the **Home** page appears.
3. On the **Home** page, set up the AT COM port; for the setting values, see section 1.8.

Check with the Windows Device Manager to find out which COM port is being used by the EVK-G45.

4. Enable the connection to the u-blox cellular module by clicking on the **Connect** button.
5. Retrieve the module and network information by clicking on the **Get Info** button.

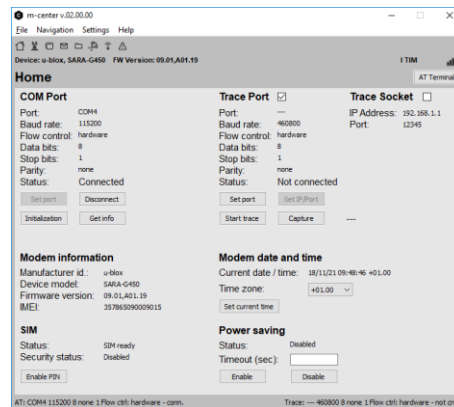

Figure 3: “Home” page

6. The module information is retrieved and displayed on the **Home** page.
7. Click on the **AT Terminal** button, found at the upper right of the **Home** page. A new window opens and the AT command terminal is now ready for communication with the EVK-G45.
8. The AT terminal is ready to use.

For the complete list of AT commands supported by the modules and their syntax, see the u-blox AT commands manual [1].

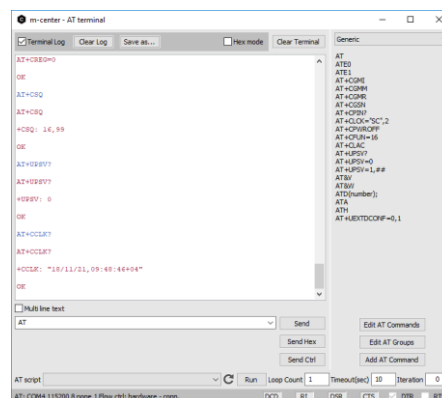

Figure 4: AT terminal window

For more information on using the u-blox m-center cellular module evaluation tool, press the F1 key on the keyboard to open the m-center help window on the computer.

## B Set up cellular packet data connection on PC

This section describes how to set up a packet data connection with the Windows 7 operating systems (for PCs) and EVK-G45, using the TCP/IP stack of the PC (external TCP/IP stack).

### B.1 Install a new modem from the control panel

1. Select: Control panel -> Phone and Modem -> Modems -> Add...

This opens the Install New Modem Wizard.

2. Select “Don’t detect my modem” checkbox.

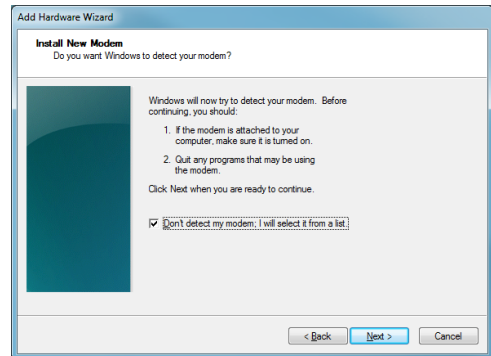

3. Select: Standard 33600 bps Modem.

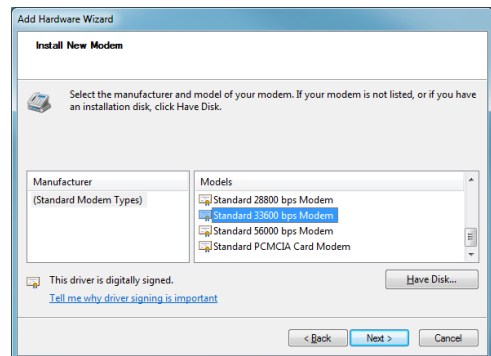

4. Set the COM-port on which the modem will be installed.

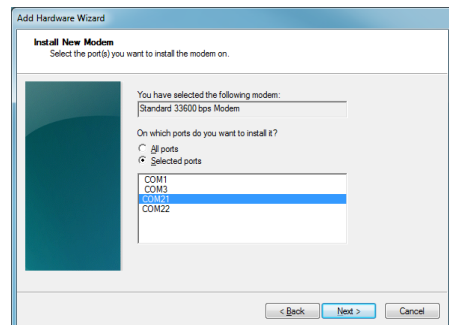

5. Select: Control panel -> Phone and Modem -> Modems -> Standard 33600 bps Modem -> Properties.

6. Select Change Settings -> Advanced.

7. Add APN settings command (APN shown is just an example. Make sure to have the correct APN defined by the network operator).

8. Select “Change Default Preferences”.

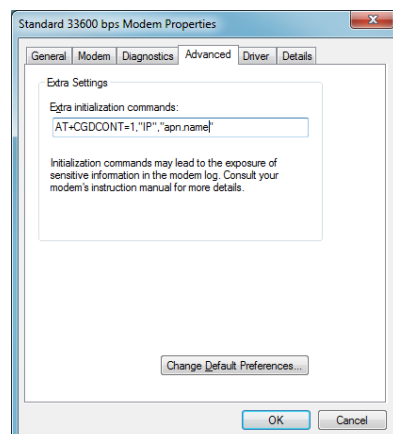

- Press OK twice, and then the new connection is ready to be configured.

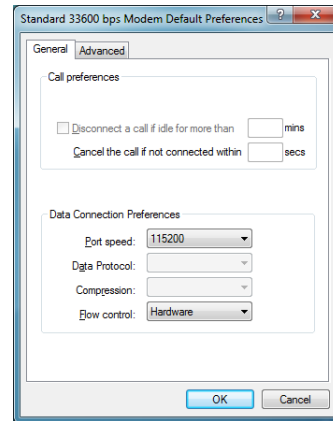

The modem can also be configured using the Device Manager by clicking on the modem name.

## B.2 Configuring a new connection

- Select: Control Panel -> Network and Sharing Center -> Set up a new connection or network.

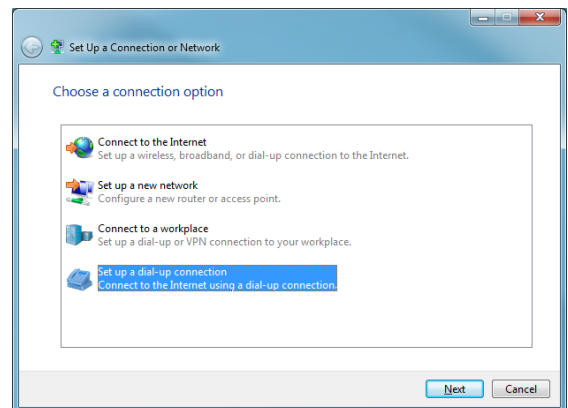

- Select the modem, if requested.

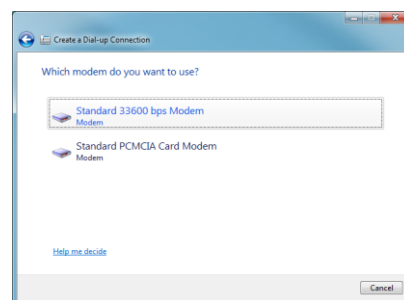

- Enter parameters for the dial-up connection:
  - the module telephone number (\*99\*\*\*1#)
  - the specific GPRS account information for the network operator
  - a name for the new connection (e.g. “u-blox GPRS Connection“)

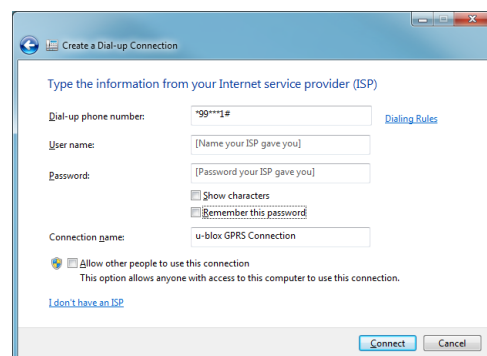

- The packet data connection is now ready to be used with the EVK-G45. To check the connection, start a browser.



 Consult the cellular network operator for username and password. In most cases, these can be left empty.

## C Examples of AT commands

For the complete description and syntax of the AT commands supported by SARA-G450 module, see the u-blox AT commands manual [\[1\]](#).

For detailed examples of AT commands for network registration and configuration, context activation, data connection management, SIM management and other module settings, see the u-blox AT commands examples application note [\[2\]](#).

### C.1 Voice call

#### Incoming voice call:

Command sent by DTE (user)	DCE response (module)	Description
	RING	Call the phone number of the SIM in the device. Incoming call.
ATA	OK	Answer to the voice call.
		Talk to the caller using the headset.
ATH	OK	Hang up.

#### Outgoing voice call:

Command sent by DTE (user)	DCE response (module)	Description
ATD+3930012345678;	OK	Outgoing voice call (+3930012345678 is written here as example).
		The voice call is accepted from the network.
		Talk to the caller using the headset.
ATH	OK	Hang up.



## C.2 SMS management

Command sent by DTE (user)	DCE response (module)	Description
AT+CMGF=1	OK	Set the text mode as the format that will be used. To be set before of the first operation.
AT+CMGS="+3930012345678" SMS TEXT MESSAGE 0123456789<CTRL- Z>	> +CMGS: 0 OK	Send 1 <sup>st</sup> SMS (+3930012345678 is written here as example).
AT+CMGS="+3930012345678" SMS TEXT MESSAGE 0123456789<CTRL- Z>	> +CMGS: 1 OK	Send 2 <sup>nd</sup> SMS (+3930012345678 is written here as example).
AT+CMGL	+CMGL:302,"REC UNREAD", "+3930012345678", "05/09/27,16:40:36+08" SMS TEXT MESSAGE 0123456789 OK	List all the incoming SMSes (+3930012345678 is written here as example).

## C.3 Internet connection in GPRS mode (external TCP/IP stack)

Command sent by DTE (user)	DCE response (module)	Description
AT+CGATT?	+CGATT: 1 OK	Check if the cellular module is attached to GPRS service (1: attached, 0: detached).
AT+CGDCONT=1,"IP","wap.tim.it"	OK	Define the PDP context parameters.
AT+CGDCONT?	+CGDCONT: 1,"IP","my_apn", "0.0.0.0",0,0 OK	
ATD*99***1#	CONNECT	Initiate the GPRS connection.
+++	OK	Disconnect with +++ sequence.

## C.4 Internet connection in GPRS mode (internal TCP/IP stack)

Command sent by DTE (user)	DCE response (module)	Description
AT+UPSD=0,1,"my_apn"	OK	Configure PDP-context parameters. Make sure to have the correct APN.
AT+UPSD=0,2,"my user-name"	OK	Username and password depend on the mobile operator used. In most cases these are not required. Simply use space or omit these commands.
AT+UPSD=0,3,"my password"	OK	
AT+UPSD=0	(configuration parameters)	Check the configuration.
AT+UPSDA=0,1	OK	Store configuration in non-volatile memory (NVM).
AT+UPSDA=0,3	OK	Activate PDP-context.

### Verify connection and PDP-context

Command sent by DTE (user)	DCE response (module)	Description
AT+UPSND=0,0	(IP address)	Check IP addresses assigned.
AT+UPSND=0,1	(IP address of DNS)	Check DNS assigned.
AT+UDNSRN=0,"www.ublox.com"	+UDNSRN: 0,"195.34.89.149" OK	Example: resolve DNS name.

## C.5 Enable communication between cellular and GNSS module

Command sent by DTE (user)	DCE response (module)	Description
AT+UGPS=1,0	OK	Enable communication. On the ADP-GNSS: LED DS118 lights green, LED DS132 blinks.

## C.6 Read NMEA messages (example: GLL)

Several NMEA messages via UART can be read. The example below shows how to read a GLL message to get the last available Geographic position Latitude / Longitude. For the full list of NMEA messages that can be read, see the u-blox AT commands manual [\[1\]](#).

Command sent by DTE (user)	DCE response (module)	Description
AT+UGGLL=1	OK	Enable the GLL message.
AT+UGGLL?	+UGGLL: (state), (GLL-msg) OK Or +UGGLL: (state), Not Available OK	Read the message. The last available GLL message is displayed.

## C.7 GNSS AssistNow

### GNSS AssistNow Online:

Command sent by DTE (user)	DCE response (module)	Description
AT+UGSRV="lscellapi.services.u-blox.com",,"123456789abcdefghijklm"	OK	Configure the aiding server.
AT+UGPS=1,4	OK	Start the GNSS.

### GNSS AssistNow Offline:

Command sent by DTE (user)	DCE response (module)	Description
AT+UGSRV="lscellapi.services.u-blox.com",,"123456789abcdefghijklm"	OK	Configure the aiding server.
AT+UGPS=1,2	OK	Start the GNSS.

## D Current consumption measurement

The current consumption of SARA-G450 module can be measured on the EVK-G45 by removing the jumper socket from the **Cellular VCC supply jumper** (J404 on the EVB), described in [Figure 5](#).

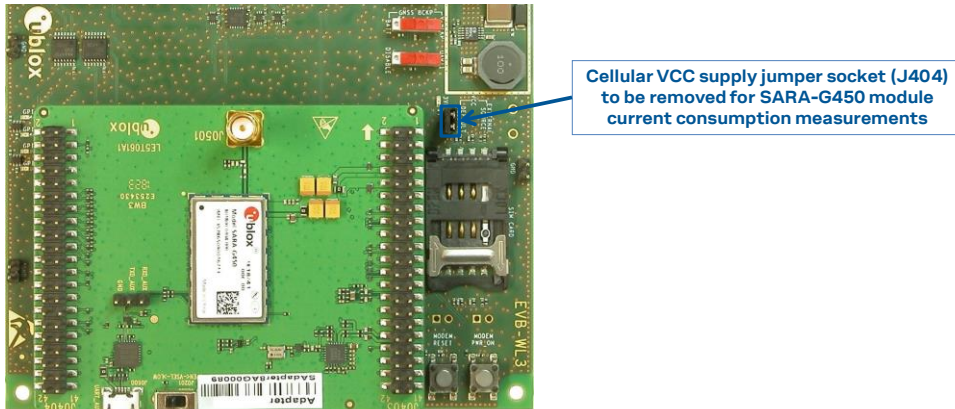

**Figure 5: Jumper socket to be removed for SARA-G450 module current consumption measurement**

A suitable external digital multi-meter (as for example, the Agilent 34410A or 34411A) can be used for current consumption measurements: in this case, the 3.8 V supply circuit on the EVB will supply the SARA-G450 module mounted on the adapter board, with the digital multi-meter placed in series as described in [Figure 6](#).

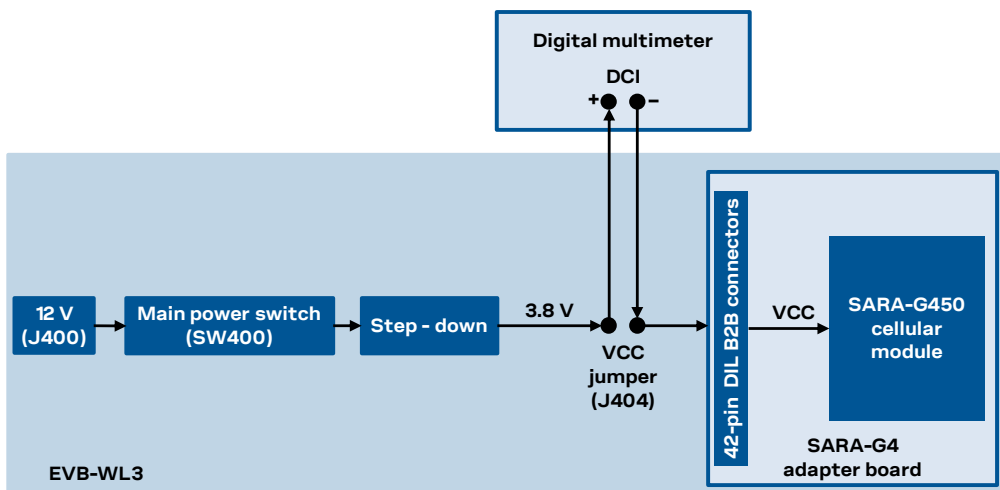

**Figure 6: Block diagram of current consumption setup for SARA-G450 modules**

Alternatively, a suitable external DC power supply with dynamic current measurement capabilities (as for example, the Agilent 66319B/D) can be used for current consumption measurements, acting also as the 3.8 V supply source for the SARA-G450 module mounted on the adapter board.

## **E Declaration of conformities**

The equipment is intended for indoor usage. It is the user's duty to verify if further restrictions apply, such as in airplanes, hospitals or hazardous locations (petrol stations, refineries...).

Any changes or modification made to this equipment will void its compliance to the safety requirements.

Maintenance, inspections and/or repairs of the EVK-G45 shall be performed by u-blox AG.

## F Glossary

Abbreviation	Definition
ADP	Adapter Board
API	Application Program Interface
APN	Access Point Name
AT	AT Command Interpreter Software Subsystem, or attention
B2B	Board-To-Board
CS	Circuit Switched
CTS	Clear To Send
DC	Direct Current
DDC	Display Data Channel interface
DIL	Dual In-Line
DNS	Domain Name Server
EVB	Evaluation Board
EVK	Evaluation Kit
GDI	Generic Digital Interfaces
GND	Ground
GNSS	Global Navigation Satellite System
GPIO	General Purpose Input Output
GPRS	General Packet Radio Service
GSM	Global System for Mobile communications
I2C	Inter-Integrated Circuit
IP	Internet Protocol
LDO	Low-DropOut regulator
LED	Light Emitting Diode
NVM	Non-Volatile Memory
PC	Personal Computer
PDN	Packet Data Network
PDP	Packet Data Protocol
PIN	Personal Identification Number
PS	Packet Switched
RF	Radio Frequency
RI	Ring Indicator
RIL	Radio Interface Layer
SIM	Subscriber Identity Module
SMA	SubMiniature version A
SMS	Short Message Service
TCP	Transfer Control Protocol
UART	Universal Asynchronous Receiver-Transmitter serial interface
URC	Unsolicited Result Code
USB	Universal Serial Bus

**Table 7: Explanation of the abbreviations and terms used**

## Related documentation

- [1] u-blox AT commands manual, [UBX-13002752](#)
- [2] u-blox AT commands examples application note, [UBX-13001820](#)
- [3] u-blox SARA-G4 series data sheet, [UBX-18006165](#)
- [4] u-blox SARA-G4 series system integration manual, [UBX-18046432](#)

 For regular updates to u-blox documentation and to receive product change notifications, register on our homepage ([www.u-blox.com](http://www.u-blox.com)).

## Revision history

Revision	Date	Name	Comments
R01	28-Nov-2018	fvid	Initial release
R02	05-Jul-2019	lpah	Updated product status
R03	28-Jan-2020	fvid	Updated product status Added examples related to voice calls and GNSS features
R04	21-May-2020	fvid	Updated product status
R05	06-Aug-2020	alos	Updated application version and PCN reference of EVK-G45-0-00
R06	08-Mar-2021	fvid	Updated EVK-G45-0-00 application version, PCN reference and status to mass production

# Contact

For complete contact information, visit us at [www.u-blox.com](http://www.u-blox.com).

## u-blox Offices

### North, Central and South America

#### u-blox America, Inc.

Phone: +1 703 483 3180  
E-mail: [info\\_us@u-blox.com](mailto:info_us@u-blox.com)

#### Regional Office West Coast:

Phone: +1 408 573 3640  
E-mail: [info\\_us@u-blox.com](mailto:info_us@u-blox.com)

#### Technical Support:

Phone: +1 703 483 3185  
E-mail: [support@u-blox.com](mailto:support@u-blox.com)

### Headquarters

#### Europe, Middle East, Africa

#### u-blox AG

Phone: +41 44 722 74 44  
E-mail: [info@u-blox.com](mailto:info@u-blox.com)  
Support: [support@u-blox.com](mailto:support@u-blox.com)

### Asia, Australia, Pacific

#### u-blox Singapore Pte. Ltd.

Phone: +65 6734 3811  
E-mail: [info\\_ap@u-blox.com](mailto:info_ap@u-blox.com)  
Support: [support\\_ap@u-blox.com](mailto:support_ap@u-blox.com)

#### Regional Office Australia:

Phone: +61 3 9566 7255  
E-mail: [info\\_anz@u-blox.com](mailto:info_anz@u-blox.com)  
Support: [support\\_ap@u-blox.com](mailto:support_ap@u-blox.com)

#### Regional Office China (Beijing):

Phone: +86 10 68 133 545  
E-mail: [info\\_cn@u-blox.com](mailto:info_cn@u-blox.com)  
Support: [support\\_cn@u-blox.com](mailto:support_cn@u-blox.com)

#### Regional Office China (Chongqing):

Phone: +86 23 6815 1588  
E-mail: [info\\_cn@u-blox.com](mailto:info_cn@u-blox.com)  
Support: [support\\_cn@u-blox.com](mailto:support_cn@u-blox.com)

#### Regional Office China (Shanghai):

Phone: +86 21 6090 4832  
E-mail: [info\\_cn@u-blox.com](mailto:info_cn@u-blox.com)  
Support: [support\\_cn@u-blox.com](mailto:support_cn@u-blox.com)

#### Regional Office China (Shenzhen):

Phone: +86 755 8627 1083  
E-mail: [info\\_cn@u-blox.com](mailto:info_cn@u-blox.com)  
Support: [support\\_cn@u-blox.com](mailto:support_cn@u-blox.com)

#### Regional Office India:

Phone: +91 80 405 092 00  
E-mail: [info\\_in@u-blox.com](mailto:info_in@u-blox.com)  
Support: [support\\_in@u-blox.com](mailto:support_in@u-blox.com)

#### Regional Office Japan (Osaka):

Phone: +81 6 6941 3660  
E-mail: [info\\_jp@u-blox.com](mailto:info_jp@u-blox.com)  
Support: [support\\_jp@u-blox.com](mailto:support_jp@u-blox.com)

#### Regional Office Japan (Tokyo):

Phone: +81 3 5775 3850  
E-mail: [info\\_jp@u-blox.com](mailto:info_jp@u-blox.com)  
Support: [support\\_jp@u-blox.com](mailto:support_jp@u-blox.com)

#### Regional Office Korea:

Phone: +82 2 542 0861  
E-mail: [info\\_kr@u-blox.com](mailto:info_kr@u-blox.com)  
Support: [support\\_kr@u-blox.com](mailto:support_kr@u-blox.com)

#### Regional Office Taiwan:

Phone: +886 2 2657 1090  
E-mail: [info\\_tw@u-blox.com](mailto:info_tw@u-blox.com)  
Support: [support\\_tw@u-blox.com](mailto:support_tw@u-blox.com)