

SF2431D

**505 MHz
SAW Filter**

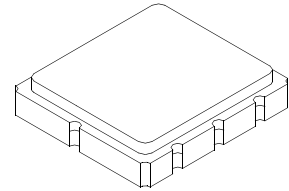

SM3838-8

- *High Performance SAW Filter*
- *3.8 x 3.8 mm Surface-mount Package*
- *Complies with Directive 2002/95/EC (RoHS)*
- *Moisture Sensitivity Level: 1*

Absolute Maximum Ratings

Rating	Value	Units
Maximum Incident Power in Passband	+10	dBm
Maximum DC Voltage Between any Two Active Terminals	3	VDC
Operable Temperature Range	-45 to +125	°C
Specification Temperature Range	-40 to +85	°C
Storage Temperature Range	-40 to +95	°C
Suitable for Lead-free Soldering - Maximum Soldering Profile	260 °C for 10 sec	

Electrical Characteristics

Characteristic	Sym	Notes	Min	Typ	Max	Units
Center Frequency	f_c			505		MHz
Insertion Loss (500 to 510 MHz)	ILmin			2.2	3.2	dB
Amplitude Ripple (500 to 510 MHz)				0.8	1.5	
Attenuation (Reference level from 0dB)						
0 to 485 MHz			40	50		dB
555 to 800 MHz			45	50		

Case Style	3.8 x 3.8 mm Nominal Footprint
Lid Symbolization, Y=year, WW=week, S=shift, Dot=pin 1 indicator	B41, YWWS

Electrical Connections

Connection	Terminals
Input	2
Output	6
Case Ground	All others

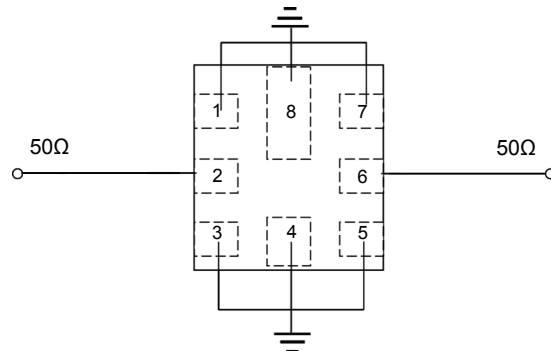

CAUTION: Electrostatic Sensitive Device. Observe precautions for handling.

NOTES:

1. The design, manufacturing process, and specifications of this device are subject to change.
2. US or International patents may apply.
3. RoHS compliant from the first date of manufacture.

Frequency Characteristics

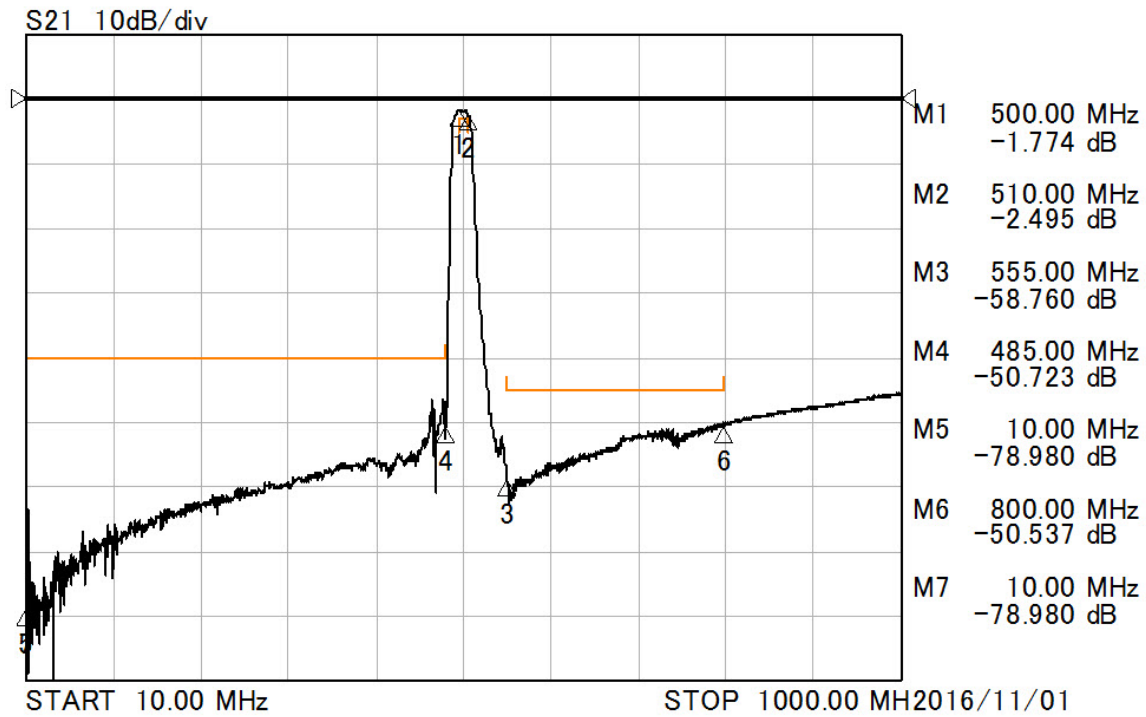
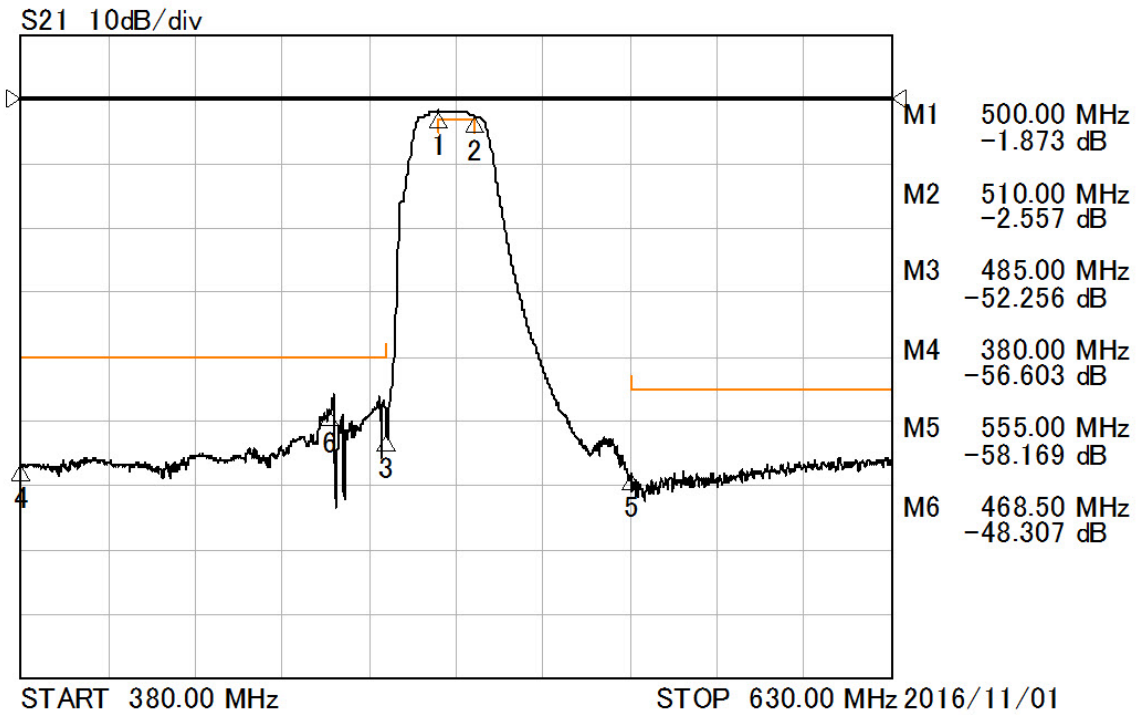

SM3838-8 Case

8-Terminal Ceramic Surface-Mount Case 3.8 X 3.8mm Nominal Footprint

Case Dimensions

Dimension	mm			Inches		
	Min	Nom	Max	Min	Nom	Max
A	3.65	3.8	3.95	0.14	0.15	0.155
B	3.65	3.8	3.95	0.14	0.15	0.155
C	-	-	1.40	-	-	0.055
D	-	1.10	-	-	0.043	-
E	-	1.0	-	-	0.04	-
F	-	0.6	-	-	0.024	-
G	-	2.54	-	-	0.100	-
H	-	1.50	-	-	0.059	-

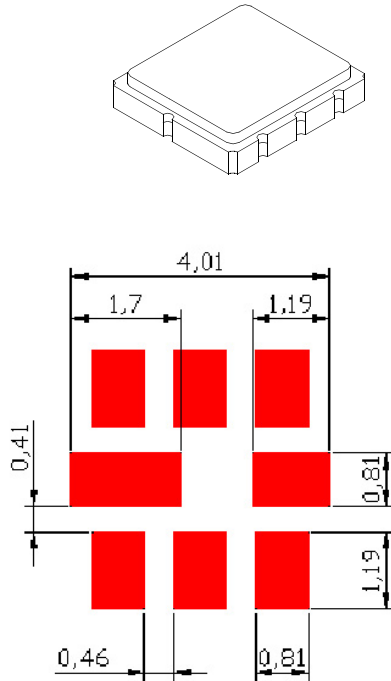

PCB Footprint

Case Materials

Materials	
Solder Pad Plating	0.3 to 1.0 μm Gold over 1.27 to 8.89 μm Nickel
Lid Plating	2.0 to 3.0 μm Nickel
Body	Al_2O_3 Ceramic

TOP VIEW

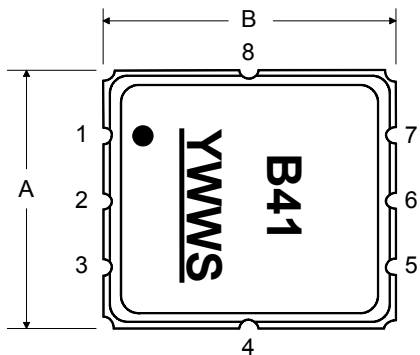

BOTTOM VIEW

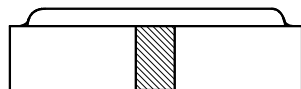
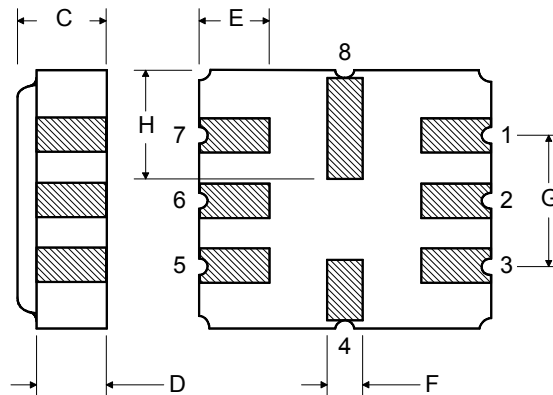

Tape and Reel Specifications

Tape and Reel Standard per ANSI/EIA-481

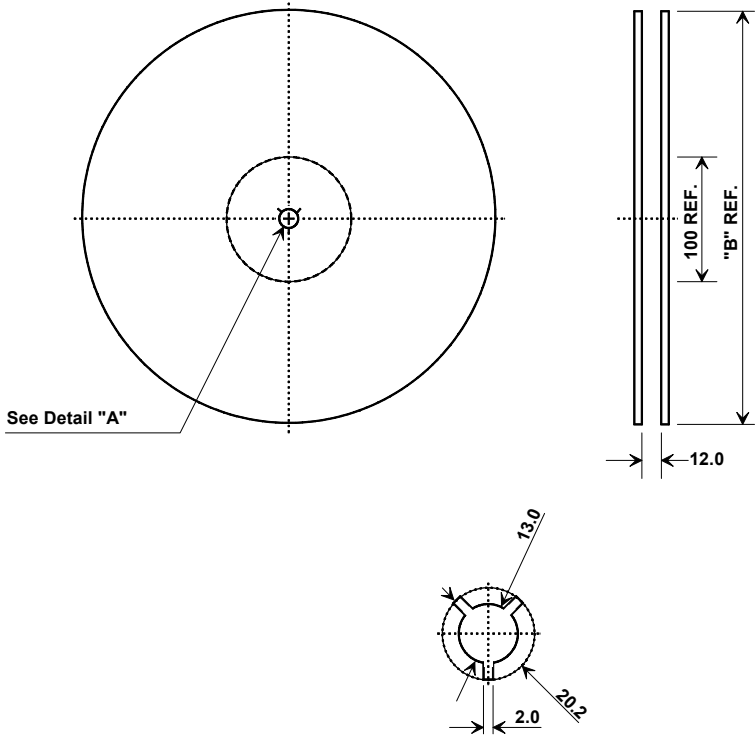

"B" Nominal Size		Quantity Per Reel
Inches	millimeters	
7	178	500
13	330	3000

COMPONENT ORIENTATION and DIMENSIONS

Carrier Tape Dimensions	
Ao	4.25 mm
Bo	4.25 mm
Ko	1.3 mm
Pitch	8.0 mm
W	12.0 mm

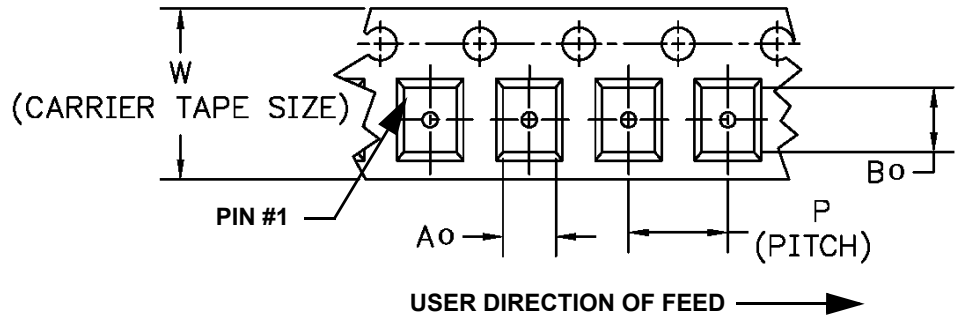
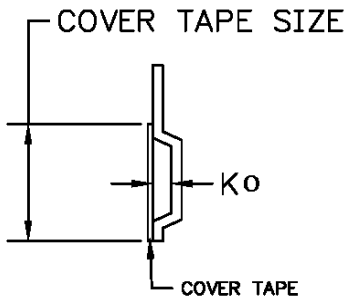

Recommended Reflow Profile

1. Preheating shall be fixed at 150~180°C for 60~90 seconds.
2. Ascending time to preheating temperature 150°C shall be 30 seconds min.
3. Heating shall be fixed at 220°C for 50~80 seconds and at 260°C +0/-5°C peak (10 seconds).
4. Time: 5 times maximum.

