



FAST RECOVERY RECTIFIER DIODES

PRELIMINARY DATASHEET

MAIN PRODUCT CHARACTERISTICS

$I_{F(AV)}$	2 x 30 A
V_{RRM}	400 V
$T_j(\text{max})$	150°C
$V_F(\text{max})$	1.3 V

FEATURES AND BENEFITS

- VERY LOW REVERSE RECOVERY TIME
- VERY LOW SWITCHING LOSSES
- LOW NOISE TURN-OFF SWITCHING

DESCRIPTION

Dual 400V rectifiers suited for Switch Mode Power Supplies and other converters.

Packaged in Max247, this device is also intended for use in welding equipment and telecom power supplies.

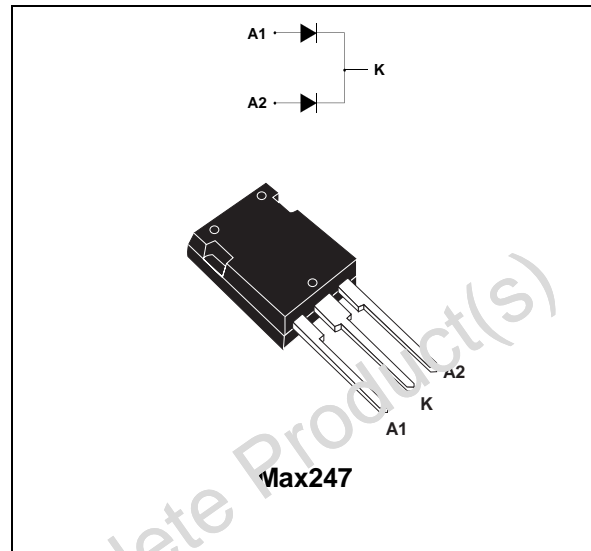

ABSOLUTE RATINGS (limiting values, per diode)

Symbol	Parameter		Value	Unit	
V_{RRM}	Repetitive peak reverse voltage		400	V	
I_{FRM}	Repetitive peak forward current	$t_p=5 \mu s$ $F=5kHz$	380	A	
$I_{F(RMS)}$	RMS forward current		50	A	
$I_{F(AV)}$	Average forward current	$T_c = 105^\circ C$ $\delta = 0.5$	Per diode	30	A
			Per device	60	
I_{FSM}	Surge non repetitive forward current	$t_p = 10 ms$ Sinusoidal	300	A	
T_{stg}	Storage temperature range		- 55 to + 150	°C	
T_j	Maximum operating junction temperature		150	°C	

BYT230Y-400

THERMAL RESISTANCES

Symbol	Parameter		Value	Unit
$R_{th(j-c)}$	Junction to case	Per diode	0.95	$^{\circ}\text{C/W}$
		Total	0.55	
$R_{th(c)}$		Coupling	0.15	$^{\circ}\text{C/W}$

When the diodes 1 and 2 are used simultaneously :

$$\Delta T_j(\text{diode } 1) = P(\text{diode } 1) \times R_{th(j-c)}(\text{Per diode}) + P(\text{diode } 2) \times R_{th(c)}$$

STATIC ELECTRICAL CHARACTERISTICS (per diode)

Symbol	Parameter	Tests Conditions		Min.	Typ.	Max.	Unit
I_R^*	Reverse leakage current	$T_j = 25^{\circ}\text{C}$	$V_R = V_{RRM}$			35	μA
		$T_j = 125^{\circ}\text{C}$			3	12	mA
V_F^{**}	Forward voltage drop	$T_j = 25^{\circ}\text{C}$	$I_F = 30\text{ A}$			1.5	V
		$T_j = 125^{\circ}\text{C}$	$I_F = 30\text{ A}$		0.9	1.3	
		$T_j = 25^{\circ}\text{C}$	$I_F = 60\text{ A}$			1.7	
		$T_j = 125^{\circ}\text{C}$	$I_F = 60\text{ A}$		1.1	1.6	

Pulse test : * $t_p = 5\text{ ms}$, $\delta < 2\%$

** $t_p = 380\text{ }\mu\text{s}$, $\delta < 2\%$

To evaluate the conduction losses use the following equation:

$$P = 1.0 \times I_{F(AV)} + 0.01 I_{F(RMS)}^2$$

RECOVERY CHARACTERISTICS

Symbol	Test Conditions		Min.	Typ.	Max.	Unit
t_{rr}	$T_j = 25^{\circ}\text{C}$	$I_F = 0.5\text{ A}$ $I_R = 1\text{ A}$ $I_{rr} = 0.25\text{ A}$			50	ns
		$I_F = 1\text{ A}$ $V_R = 30\text{ V}$ $di_F/dt = -15\text{ A}/\mu\text{s}$			100	

TURN-OFF SWITCHING CHARACTERISTICS (without serie inductance)

Symbol	Test Conditions		Min.	Typ.	Max.	Unit
t_{IRM}	$di_F/dt = -120\text{ A}/\mu\text{s}$	$V_{CC} = 200\text{ V}$ $I_F = 30\text{ A}$ $L_p = 0.05\text{ }\mu\text{H}$ $T_j = 100^{\circ}\text{C}$			75	ns
	$di_F/dt = -240\text{ A}/\mu\text{s}$			50		
I_{RM}	$di_F/dt = -120\text{ A}/\mu\text{s}$				9	A
	$di_F/dt = -240\text{ A}/\mu\text{s}$			12		

TURN-OFF OVERVOLTAGE CORFFICIENT (with serie inductance)

Symbol	Test Conditions		Min.	Typ.	Max.	Unit
$C = \frac{V_{RP}}{V_{CC}}$	$T_j = 100^{\circ}\text{C}$ $V_{CC} = 60\text{ V}$ $I_F = I_{F(AV)}$ $di_F/dt = -30\text{ A}/\mu\text{s}$ $L_p = 1\text{ }\mu\text{H}$			3.3		/

Fig. 1: Average forward power dissipation versus average forward current (per diode).

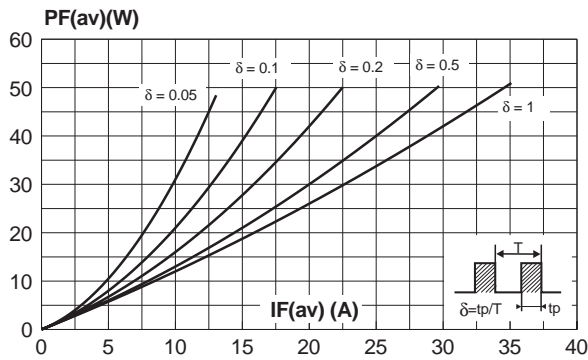

Fig. 2: Peak current versus form factor (per diode).

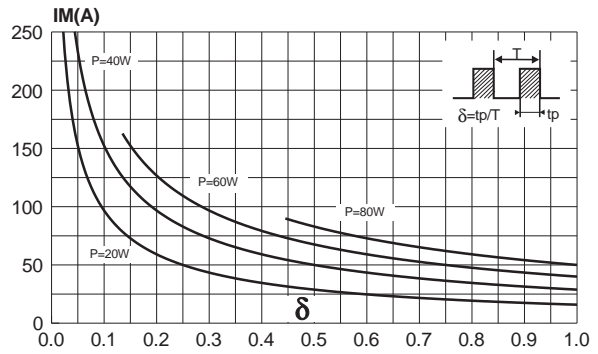

Fig. 3: Average forward current versus ambient temperature ($\delta=0.5$, per diode).

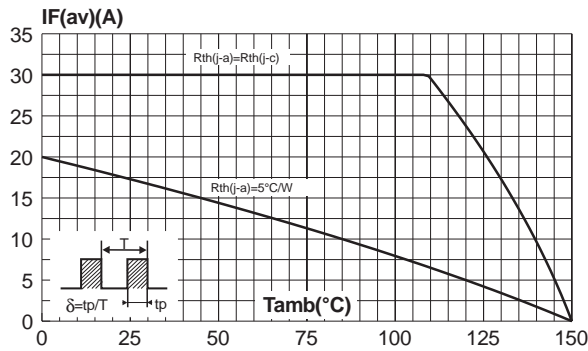

Fig. 4: Non repetitive surge peak forward current versus overload duration (per diode).

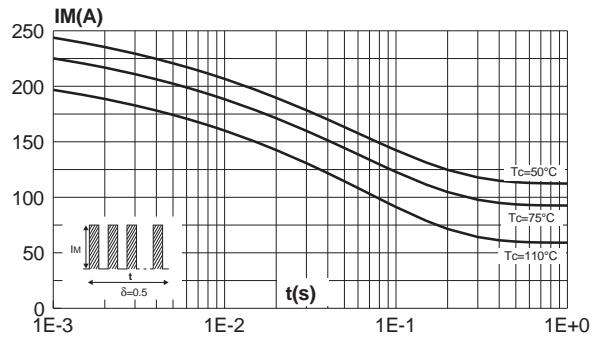

Fig. 5: Relative variation of thermal impedance junction to case versus pulse duration (per diode).

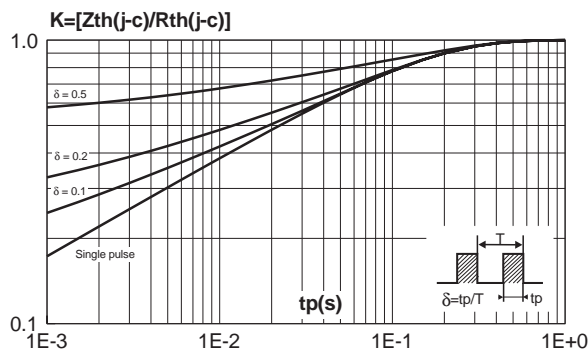
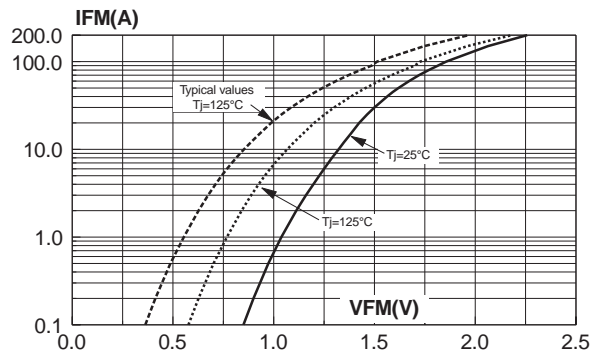

Fig. 6: Forward voltage drop versus forward current (maximum values, per diode).



BYT230Y-400

Fig. 7: Junction capacitance versus reverse voltage applied (typical values, per diode).

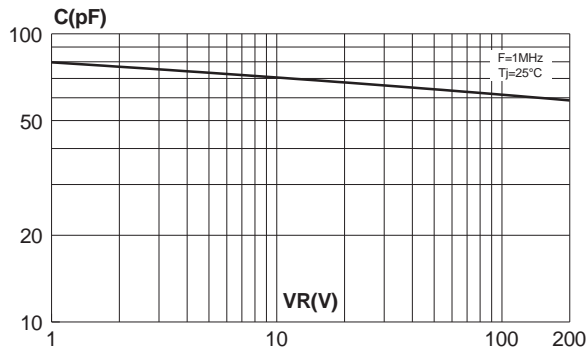

Fig. 8: Recovery charges versus dI_F/dt (per diode).

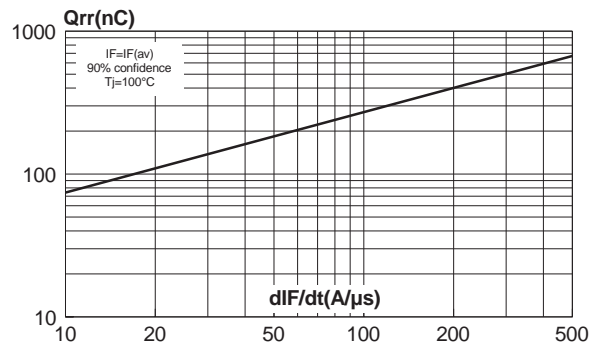

Fig. 9: Recovery current versus dI_F/dt (per diode).

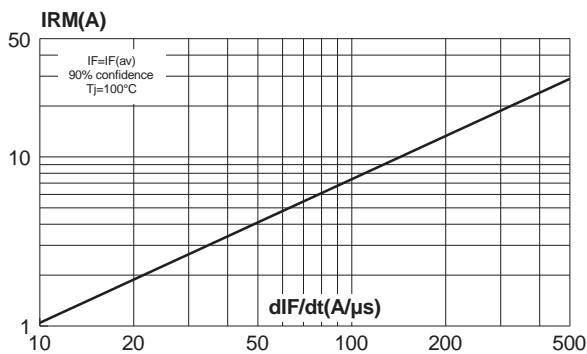

Fig. 10: Transient peak forward versus dI_F/dt (per diode).

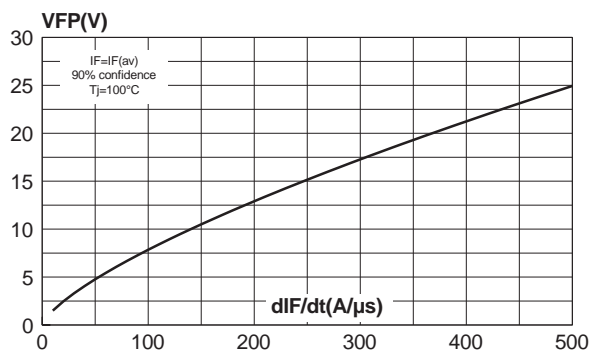

Fig. 11: Forward recovery time versus dI_F/dt (per diode).

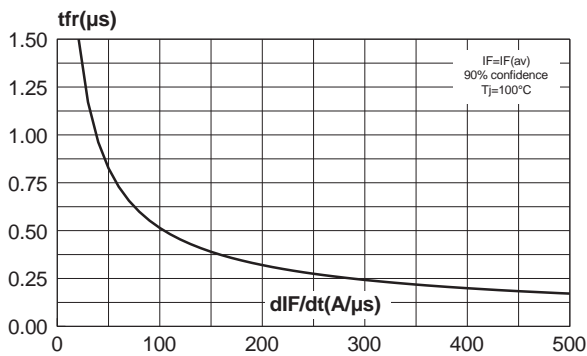
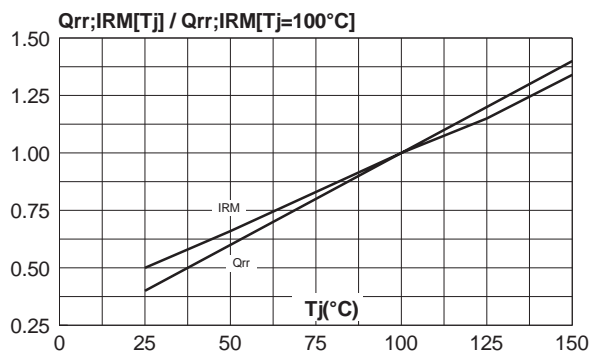
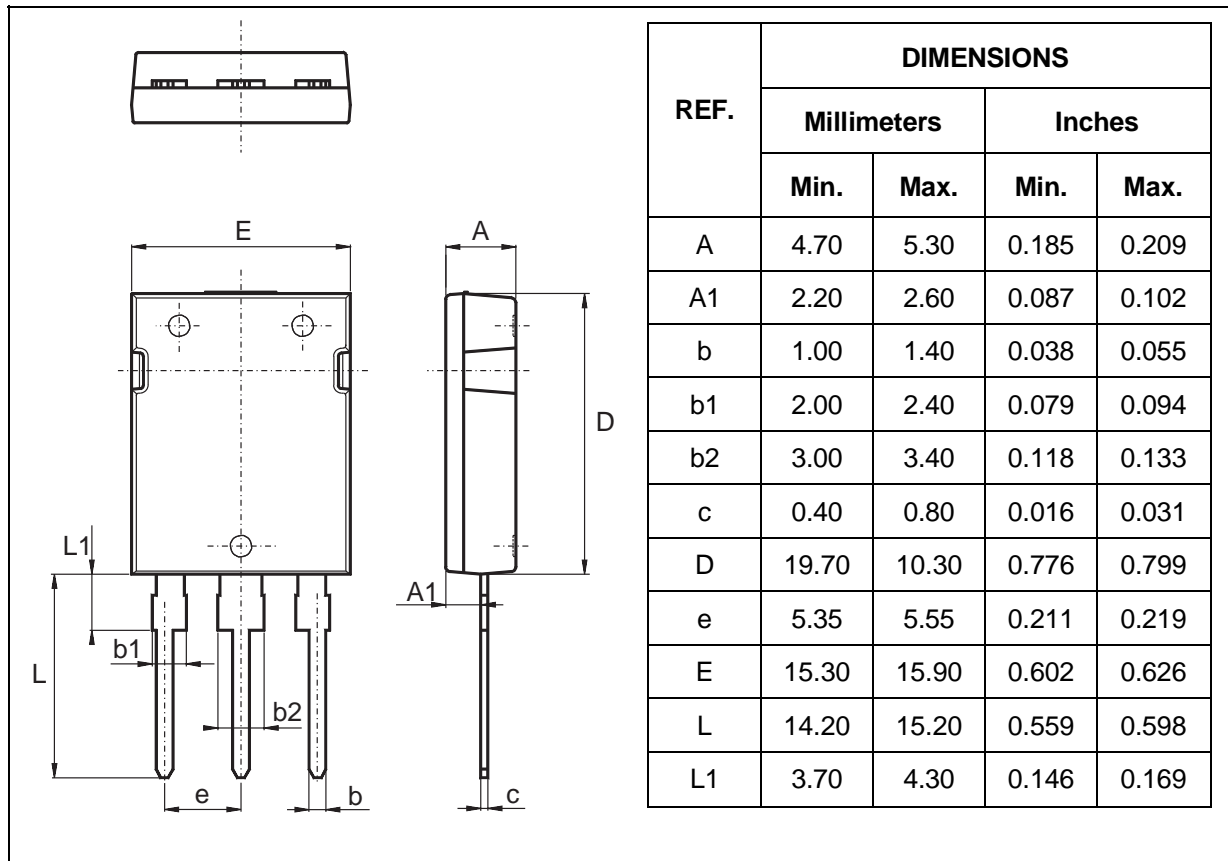

Fig. 12: Dynamic parameters versus junction temperature.



PACKAGE MECHANICAL DATA

Max247



Ordering type	Marking	Package	Weight	Base qty	Delivery mode
BYT230Y-400	BYT230Y-400	Max247	5 g.	30	Tube

- Epoxy meets UL94, V0

Information furnished is believed to be accurate and reliable. However, STMicroelectronics assumes no responsibility for the consequences of use of such information nor for any infringement of patents or other rights of third parties which may result from its use. No license is granted by implication or otherwise under any patent or patent rights of STMicroelectronics. Specifications mentioned in this publication are subject to change without notice. This publication supersedes and replaces all information previously supplied. STMicroelectronics products are not authorized for use as critical components in life support devices or systems without express written approval of STMicroelectronics.

The ST logo is a registered trademark of STMicroelectronics

© 1999 STMicroelectronics - Printed in Italy - All rights reserved.

STMicroelectronics GROUP OF COMPANIES

Australia - Brazil - China - Finland - France - Germany - Hong Kong - India - Italy - Japan - Malaysia
Malta - Morocco - Singapore - Spain - Sweden - Switzerland - United Kingdom - U.S.A.

<http://www.st.com>