



WTS26P-24161120A00

W26

COMPACT PHOTOELECTRIC SENSORS

SICK
Sensor Intelligence.



Illustration may differ

Ordering information

| Type | Part no. |
|--------------------|----------|
| WTS26P-24161120A00 | 1218668 |

Other models and accessories → www.sick.com/W26



Detailed technical data

Features

| | |
|---|---|
| Device type | Photoelectric sensors |
| Functional principle | Photoelectric proximity sensor |
| Functional principle detail | Background suppression, TwinEye technology |
| Sensing range | |
| Sensing range min. | 10 mm |
| Sensing range max. | 1,000 mm |
| Adjustable switching threshold for background suppression | 150 mm ... 1,000 mm |
| Reference object | Object with 90% remission (based on standard white, DIN 5033) |
| Minimum distance between set sensing range and background (black 6% / white 90%) | 25 mm, at a distance of 500 mm |
| Recommended sensing range for the best performance | 200 mm ... 500 mm |
| Emitted beam | |
| Light source | PinPoint LED |
| Type of light | Visible red light |
| Shape of light spot | Point-shaped |
| Light spot size (distance) | Ø 10 mm (550 mm) |
| Maximum dispersion of the emitted beam around the standardized transmission axis (squint angle) | < +/- 1.0° (at Ta = +23 °C) |

| | |
|--|--|
| Key LED figures | |
| Normative reference | EN 62471:2008-09 IEC 62471:2006, modified |
| LED risk group marking | Free group |
| Wave length | 635 nm |
| Average service life | 100,000 h at T _a = +25 °C |
| Adjustment | |
| Teach-Turn adjustment | BluePilot: For setting the sensing range |
| IO-Link | For configuring the sensor parameters and Smart Task functions |
| Indication | |
| LED blue | BluePilot: sensing range indicator |
| LED green | Operating indicator Static on: power on Flashing: IO-Link mode |
| LED yellow | Status of received light beam Static on: object present Static off: object not present |
| Special applications | |
| Detecting uneven, shiny objects, Detecting objects wrapped in film | |

Safety-related parameters

| | |
|-------------------------------------|--|
| MTTF_D | 415 years |
| DC_{avg} | 0 % |
| T_M (mission time) | 20 years (EN ISO 13849) Rate of use: 60 % |

Communication interface

| | |
|-----------------------------|--|
| IO-Link | |
| | ✓, V1.1 |
| Data transmission rate | COM2 (38,4 kBaud) |
| Cycle time | 2.3 ms |
| Process data length | 16 Bit |
| Process data structure | Bit 0 = switching signal Q _{L1} Bit 1 = switching signal Q _{L2} Bit 2 ... 15 = empty |
| VendorID | 26 |
| DeviceID HEX | 0x80017C |
| DeviceID DEC | 8388988 |
| Compatible master port type | A |
| SIO mode support | Yes |

Electrical data

| | |
|-------------------------------------|--|
| Supply voltage U_B | 10 V DC ... 30 V DC ¹⁾ |
| Ripple | ≤ 5 V _{pp} |
| Usage category | DC-12 (According to EN 60947-5-2) DC-13 (According to EN 60947-5-2) |
| Current consumption | ≤ 30 mA, without load. At U _B = 24 V |
| Protection class | III |

¹⁾ Limit values.

²⁾ Signal transit time with resistive load in switching mode.

³⁾ With light/dark ratio 1:1.

| | |
|---------------------------------------|---|
| Digital output | |
| Number | 2 (Complementary) |
| Type | Push-pull: PNP/NPN |
| Signal voltage PNP HIGH/LOW | Approx. $U_B - 2.5 \text{ V} / 0 \text{ V}$ |
| Signal voltage NPN HIGH/LOW | Approx. $U_B / < 2.5 \text{ V}$ |
| Output current I_{max} | $\leq 100 \text{ mA}$ |
| Circuit protection outputs | Reverse polarity protected Overcurrent and short-circuit protected |
| Response time | $\leq 1.4 \text{ ms}^{2)}$ |
| Repeatability (response time) | $750 \mu\text{s}$ |
| Switching frequency | $350 \text{ Hz}^{3)}$ |
| Pin/Wire assignment | |
| Function of pin 4/black (BK) | Digital output, light switching, object present → output Q_{L1} HIGH; IO-Link communication C |
| Function of pin 4/black (BK) – detail | The pin 4 function of the sensor can be configured, Additional possible settings via IO-Link |
| Function of pin 2/white (WH) | Digital output, dark switching, object present → output \bar{Q}_{L1} LOW |
| Function of pin 2/white (WH) – detail | The pin 2 function of the sensor can be configured, Additional possible settings via IO-Link |

¹⁾ Limit values.

²⁾ Signal transit time with resistive load in switching mode.

³⁾ With light/dark ratio 1:1.

Mechanical data

| | |
|---|-----------------------------|
| Housing | Rectangular |
| Dimensions (W x H x D) | 24.6 mm x 82.5 mm x 53.3 mm |
| Connection | Male connector M12, 4-pin |
| Material | |
| Housing | Plastic, VISTAL® |
| Front screen | Plastic, PMMA |
| Male connector | Plastic, VISTAL® |
| Weight | Approx. 80 g |
| Maximum tightening torque of the fixing screws | 1.3 Nm |

Ambient data

| | |
|--------------------------------------|--|
| Enclosure rating | IP66 (EN 60529) IP67 (EN 60529) IP69 (EN 60529) ¹⁾ |
| Ambient operating temperature | -40 °C ... +60 °C |
| Ambient temperature, storage | -40 °C ... +75 °C |
| Shock resistance | 50 g, 11 ms (25 positive and 25 negative shocks per axis, for X, Y, Z axes, 150 shocks in total (EN60068-2-27)) 50 g, 6 ms (5,000 positive and 5,000 negative shocks per axis, for X, Y, Z axes, 30,000 shocks in total (EN60068-2-27)) |
| Vibration resistance | 10 Hz ... 2,000 Hz (Amplitude 0.5 mm / 10 g, 20 sweeps per axis, for X, Y, Z axes, 1 octave/min, (EN60068-2-6)) |
| Air humidity | 35 % ... 95 %, Relative humidity (no condensation) |

¹⁾ Replaces IP69K with ISO 20653: 2013-03.

| | |
|--|------------------------------|
| Electromagnetic compatibility (EMC) | EN 60947-5-2 |
| Resistance to cleaning agent | ECOLAB |
| UL File No. | NRKH.E181493 & NRKH7.E181493 |

¹⁾ Replaces IP69K with ISO 20653: 2013-03.

Smart Task

| | |
|---------------------------------|--|
| Smart Task name | Base logics |
| Logic function | Direct AND OR Window Hysteresis |
| Timer function | Deactivated On delay Off delay ON and OFF delay Impulse (one shot) |
| Inverter | Yes |
| Switching frequency | SIO Logic: 300 Hz ¹⁾ IOL: 280 Hz ²⁾ |
| Response time | SIO Logic: 1.65 ms ¹⁾ IOL: 1.75 ms ²⁾ |
| Repeatability | SIO Logic: 800 µs ¹⁾ IOL: 900 µs ²⁾ |
| Switching signal | |
| Switching signal Q_{L1} | Switching output |
| Switching signal \bar{Q}_{L1} | Switching output |

¹⁾ Use of Smart Task functions without IO-Link communication (SIO mode).

²⁾ Use of Smart Task functions with IO-Link communication function.

Diagnosis

| | |
|-------------------------|-----|
| Device status | Yes |
| Quality of teach | Yes |

Classifications

| | |
|---------------------|----------|
| eCl@ss 5.0 | 27270904 |
| eCl@ss 5.1.4 | 27270904 |
| eCl@ss 6.0 | 27270904 |
| eCl@ss 6.2 | 27270904 |
| eCl@ss 7.0 | 27270904 |
| eCl@ss 8.0 | 27270904 |
| eCl@ss 8.1 | 27270904 |
| eCl@ss 9.0 | 27270904 |
| eCl@ss 10.0 | 27270904 |
| eCl@ss 11.0 | 27270904 |
| eCl@ss 12.0 | 27270903 |
| ETIM 5.0 | EC002719 |

| | |
|-----------------------|----------|
| ETIM 6.0 | EC002719 |
| ETIM 7.0 | EC002719 |
| ETIM 8.0 | EC002719 |
| UNSPSC 16.0901 | 39121528 |

Connection type

M12 male connector, 4-pin

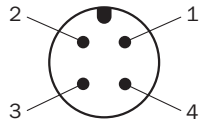

Connection diagram

Cd-390

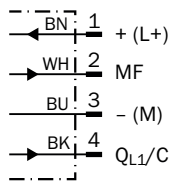

Characteristic curve

WTS26P-xxxxx1xx

Minimum distance in mm (y) between the set sensing range (x) and white background (90 % remission)

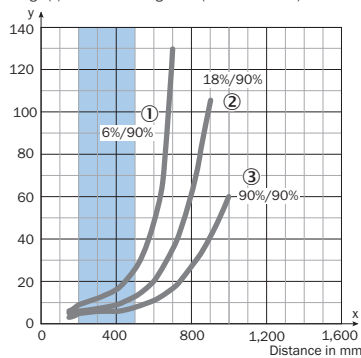

Recommended sensing range for the best performance

- ① Sensing range on black, 6% remission
- ② Sensing range on gray, 18 % remission
- ③ Sensing range on white, 90% remission

Example:
Safe suppression of the background

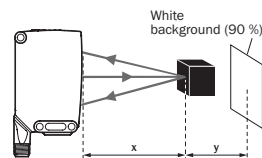

Black object (6 % remission)
Set sensing range $x = 500$ mm
Needed minimum distance to white background $y = 25$ mm

Light spot size

WTS26P-xxxx1xx

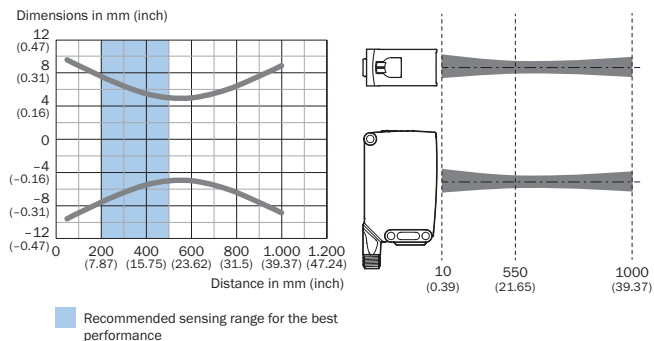

Sensing range diagram

WTS26P-xxxx1xx

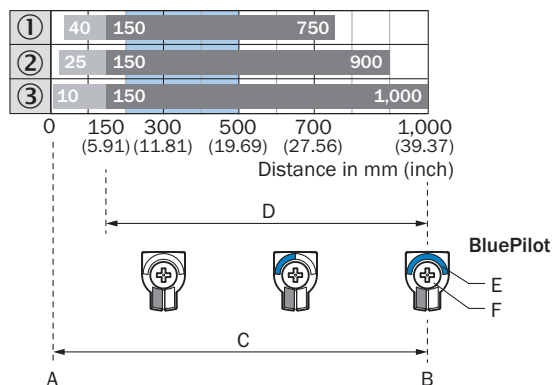

Recommended sensing range for the best performance

| | |
|---|---|
| 1 | Black object, 6% remission factor |
| 2 | Gray object, 18% remission factor |
| 3 | White object, 90% remission factor |
| A | Sensing range min. in mm |
| B | Sensing range max. in mm |
| C | Field of view |
| D | Adjustable switching threshold for background suppression |
| E | Sensing range indicator |
| F | Teach-Turn adjustment |

Adjustments

Display and adjustment elements

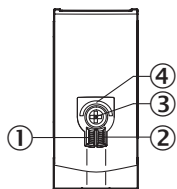

- ① LED indicator green
- ② LED indicator yellow
- ③ Teach-Turn adjustment
- ④ LED blue

Dimensional drawing (Dimensions in mm (inch))

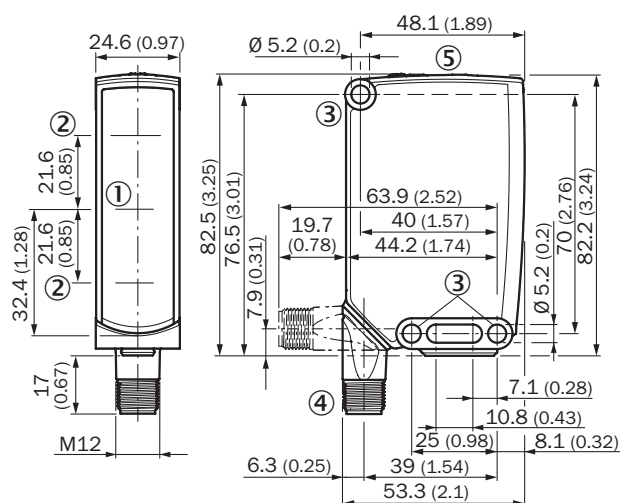

- ① Center of optical axis, sender
- ② Center of optical axis, receiver
- ③ Mounting hole, \varnothing 5.2 mm
- ④ Connection
- ⑤ Display and adjustment elements

Recommended accessories

Other models and accessories → www.sick.com/W26

| | Brief description | Type | Part no. |
|------------------------------------|--|--------------------|----------|
| Universal bar clamp systems | | | |
| | Plate N12 for universal clamp. For mounting PL30A, P250 reflectors, W27 and WTR2 sensors., Zinc plated steel (sheet), Zinc die cast (clamping bracket), Universal clamp (2022726), mounting hardware | BEF-KHS-N12 | 2071950 |
| Plug connectors and cables | | | |
| | Head A: female connector, M12, 4-pin, straight, A-coded Head B: Flying leads Cable: Sensor/actuator cable, PVC, unshielded, 5 m | YF2A14-050VB3XLEAX | 2096235 |

| | Brief description | Type | Part no. |
|---|---|------------|----------|
|  | Head A: male connector, M12, 4-pin, straight Cable: unshielded | STE-1204-G | 6009932 |

Recommended services

Additional services → www.sick.com/W26

| | Type | Part no. |
|---|------------------------|------------|
| Function Block Factory <ul style="list-style-type: none"> Description: The Function Block Factory supports common programmable logic controllers (PLCs) from various manufacturers, such as Siemens, Beckhoff, Rockwell Automation and B&R. More information on the FBF can be found <a _blank"="" href="https://fbf.cloud.sick.com target=">here. | Function Block Factory | On request |

SICK AT A GLANCE

SICK is one of the leading manufacturers of intelligent sensors and sensor solutions for industrial applications. A unique range of products and services creates the perfect basis for controlling processes securely and efficiently, protecting individuals from accidents and preventing damage to the environment.

We have extensive experience in a wide range of industries and understand their processes and requirements. With intelligent sensors, we can deliver exactly what our customers need. In application centers in Europe, Asia and North America, system solutions are tested and optimized in accordance with customer specifications. All this makes us a reliable supplier and development partner.

Comprehensive services complete our offering: SICK LifeTime Services provide support throughout the machine life cycle and ensure safety and productivity.

For us, that is “Sensor Intelligence.”

WORLDWIDE PRESENCE:

Contacts and other locations –www.sick.com