

# SFH 205 F

## Radial Sidelooker

Silicon PIN Photodiode with Daylight Blocking Filter



### Applications

- Electronic Equipment
- Highbay Industrial
- Industrial Automation (Machine Controls, Light Barriers, Vision Controls)
- Smoke/Dust/Particle Sensing
- White Goods

### Features:

- Package: black epoxy
- Qualifications: The product qualification test plan is based on the guidelines of AEC-Q101-REV-C, Stress Test Qualification for Automotive Grade Discrete Semiconductors.
- ESD: 2 kV acc. to ANSI/ESDA/JEDEC JS-001 (HBM, Class 2)
- Especially suitable for applications of 950 nm
- Short switching time (typ. 20 ns)
- 5 mm LED plastic package
- Also available on tape and reel

### Ordering Information

Type	Photocurrent <sup>1)</sup> $E_e = 1 \text{ mW/cm}^2; \lambda = 950 \text{ nm}; V_R = 5 \text{ V}$ $I_P$	Photocurrent typ. $E_e = 1 \text{ mW/cm}^2; \lambda = 950 \text{ nm}; V_R = 5 \text{ V}$ $I_P$	Ordering Code
SFH 205 F	$\geq 45 \mu\text{A}$	60 $\mu\text{A}$	Q62702P0102

Not for new design

## Maximum Ratings

 $T_A = 25\text{ °C}$ 

Parameter	Symbol		Values
Operating Temperature	$T_{op}$	min. max.	-40 °C 100 °C
Storage temperature	$T_{stg}$	min. max.	-40 °C 100 °C
Reverse voltage	$V_R$	max.	32 V
Total power dissipation	$P_{tot}$	max.	150 mW
ESD withstand voltage acc. to ANSI/ESDA/JEDEC JS-001 (HBM, Class 2)	$V_{ESD}$	max.	2 kV

## Characteristics

$T_A = 25\text{ °C}$

Parameter	Symbol		Values
Wavelength of max sensitivity	$\lambda_{S\text{ max}}$	typ.	950 nm
Spectral range of sensitivity	$\lambda_{10\%}$	typ.	800 ... 1100 nm
Radiant sensitive area	A	typ.	7.02 mm <sup>2</sup>
Dimensions of active chip area	L x W	typ.	2.65 x 2.65 mm x mm
Half angle	$\varphi$	typ.	60 °
Dark current	$I_R$	typ.	2 nA
$V_R = 10\text{ V}$		max.	30 nA
Spectral sensitivity of the chip $\lambda = 950\text{ nm}$	$S_\lambda$	typ.	0.7 A / W
Quantum yield of the chip $\lambda = 950\text{ nm}$	$\eta$	typ.	0.91 Electrons / Photon
Open-circuit voltage $E_e = 0.5\text{ mW/cm}^2; \lambda = 950\text{ nm}$	$V_O$	min. typ.	250 mV 330 mV
Short-circuit current $E_e = 0.5\text{ mW/cm}^2; \lambda = 950\text{ nm}$	$I_{sc}$	typ.	28 $\mu$ A
Rise time $V_R = 5\text{ V}; R_L = 50\ \Omega; \lambda = 950\text{ nm}; I_p = 800\ \mu\text{A}$	$t_r$	typ.	0.02 $\mu$ s
Fall time $V_R = 5\text{ V}; R_L = 50\ \Omega; \lambda = 950\text{ nm}; I_p = 800\ \mu\text{A}$	$t_f$	typ.	0.02 $\mu$ s
Forward voltage $I_F = 100\text{ mA}; E = 0$	$V_F$	typ.	1.3 V
Capacitance $V_R = 0\text{ V}; f = 1\text{ MHz}; E = 0$	$C_0$	typ.	72 pF
Temperature coefficient of voltage	$TC_V$	typ.	-2.6 mV / K
Temperature coefficient of short-circuit current $\lambda = 950\text{ nm}$	$TC_I$	typ.	0.18 % / K
Noise equivalent power $V_R = 10\text{ V}; \lambda = 950\text{ nm}$	NEP	typ.	0.036 pW / Hz <sup>1/2</sup>
Detection limit $V_R = 10\text{ V}; \lambda = 950\text{ nm}$	$D^*$	typ.	7.3e12 cm x Hz <sup>1/2</sup> / W

### Relative Spectral Sensitivity <sup>2), 3)</sup>

$$S_{rel} = f(\lambda)$$

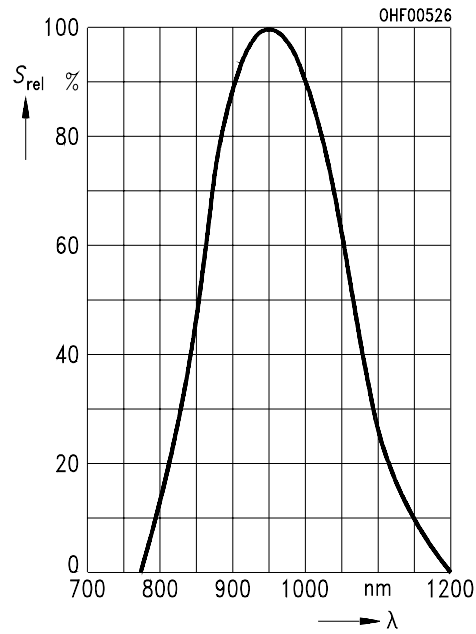

### Directional Characteristics <sup>2), 3)</sup>

$$S_{rel} = f(\varphi)$$

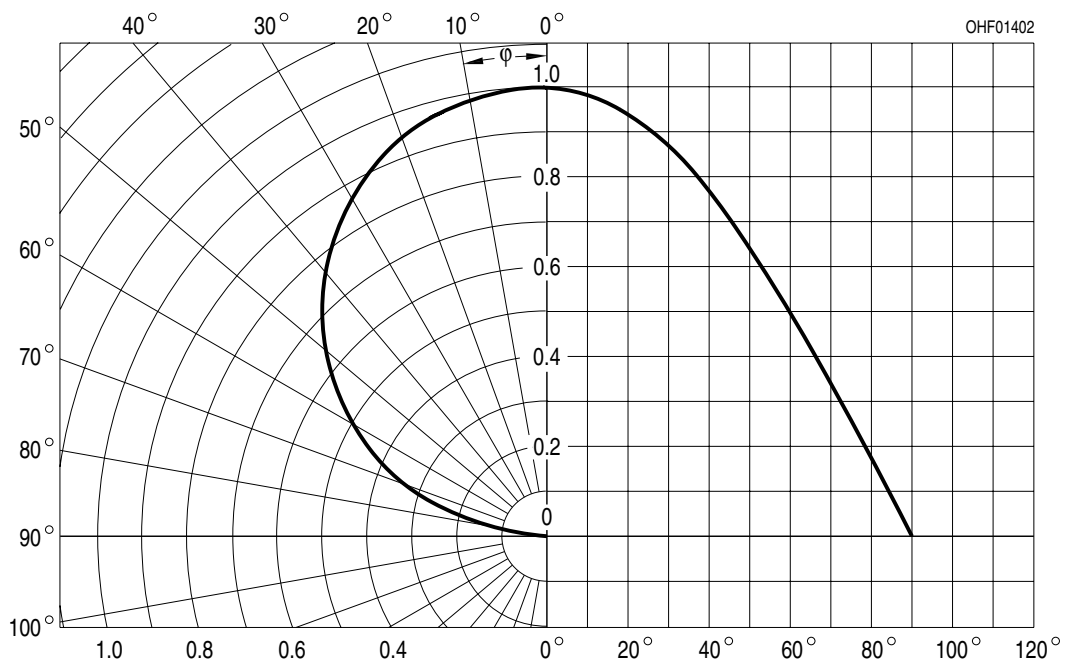

Not for new design

**Photocurrent/Open-Circuit Voltage** 2), 3)

$I_P (V_R = 5 \text{ V}) / V_O = f(E_e)$

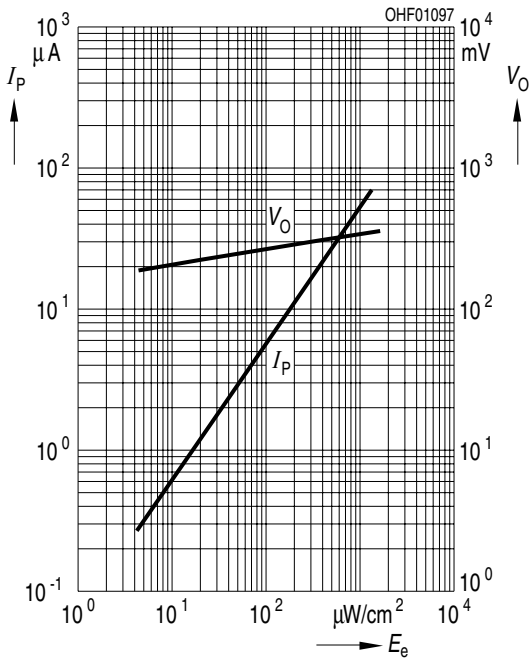

**Dark Current** 2), 3)

$I_R = f(V_R); E = 0$

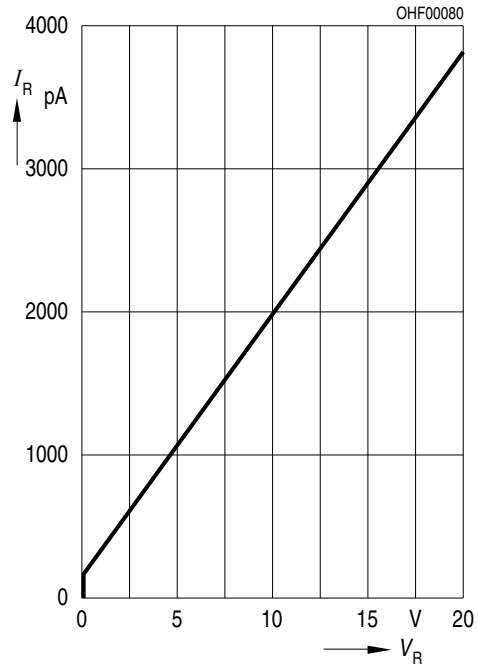

**Capacitance** 2), 3)

$C = f(V_R); f = 1\text{MHz}; E = 0; T_A = 25^\circ\text{C}$

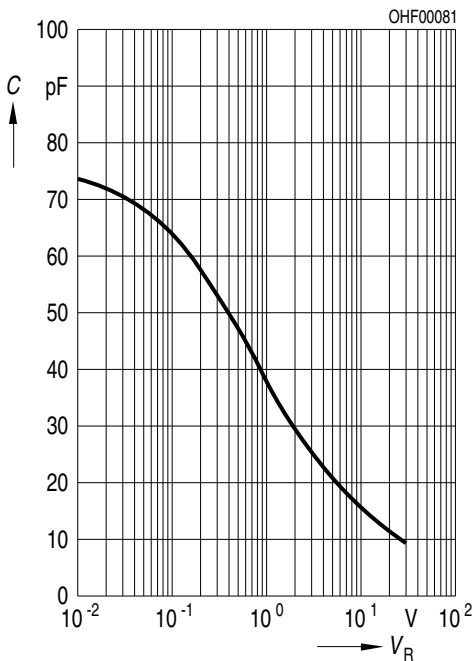

Not for new design

## Dark Current <sup>2)</sup>

$$I_R = f(T_A); E = 0; V_R = 10 \text{ V}$$

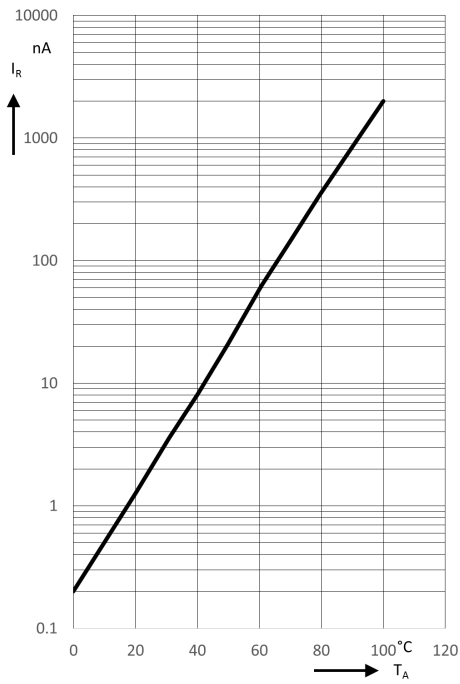

## Power Consumption

$$P_{\text{tot}} = f(T_A)$$

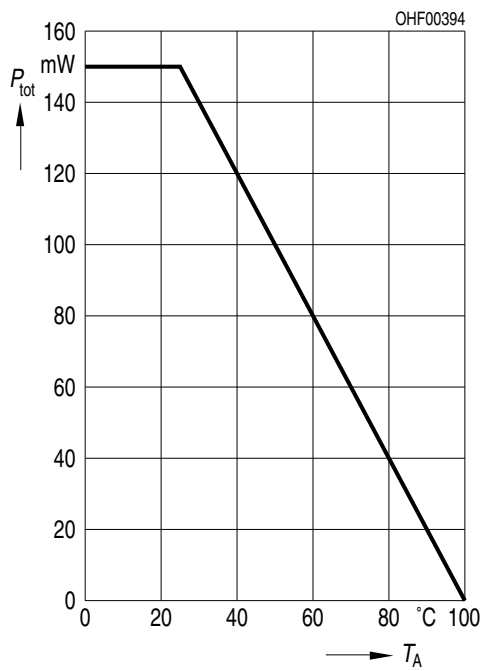

Not for new design

**Dimensional Drawing** <sup>4)</sup>

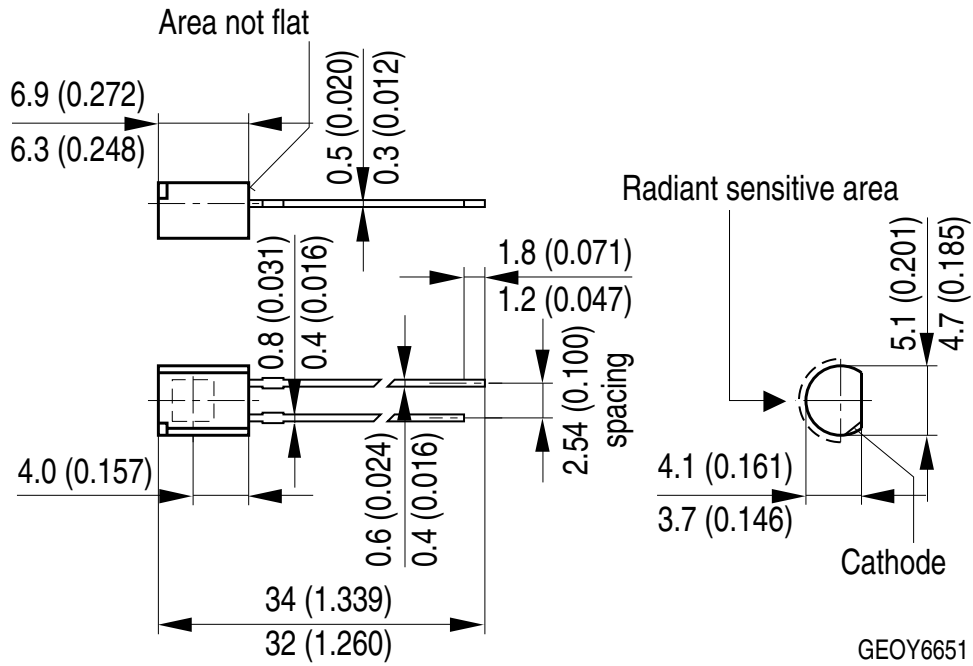

GEOY6651

**Further Information:**

**Approximate Weight:** 276.0 mg

**Package marking:** Cathode

Not for new design

**Recommended Solder Pad** <sup>4)</sup>

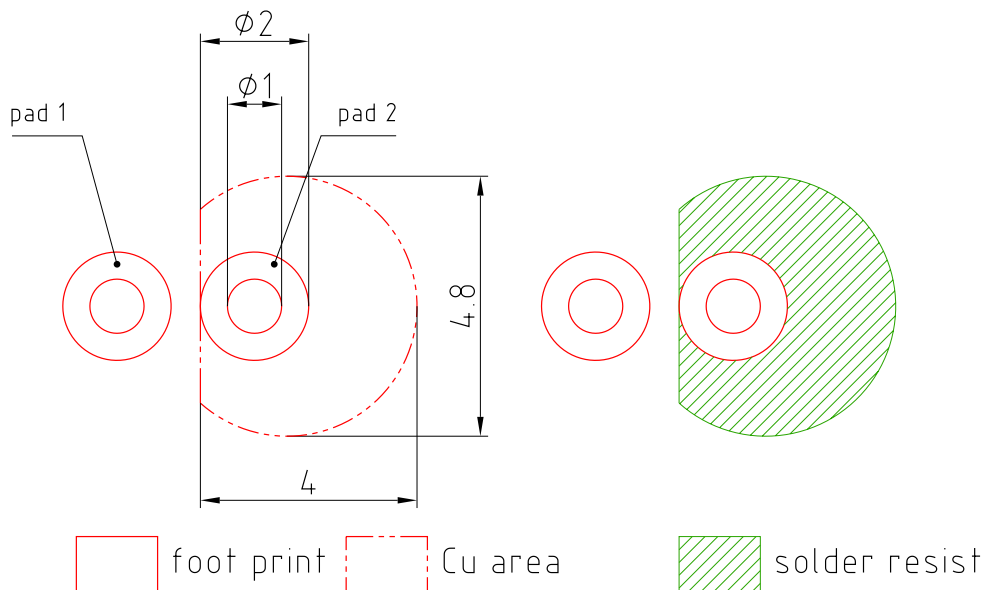

E062.3010.188-01

Pad 1: anode

Not for new design



# TTW Soldering

IEC-61760-1 TTW

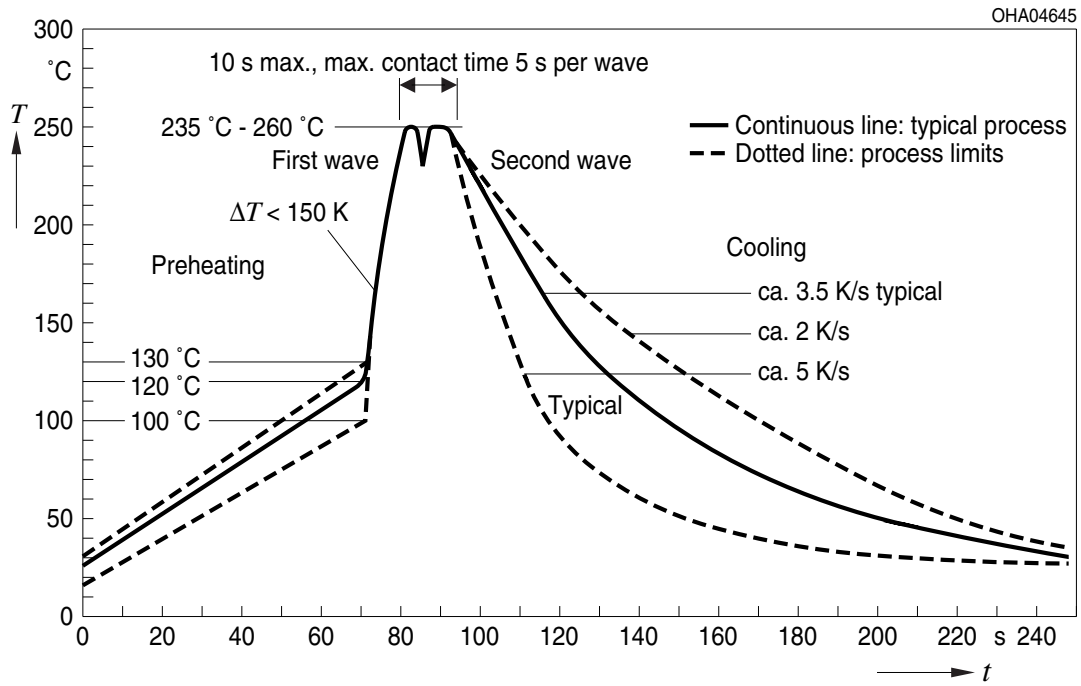

Not for new design

---

## Notes

The evaluation of eye safety occurs according to the standard IEC 62471:2006 (photo biological safety of lamps and lamp systems). Within the risk grouping system of this IEC standard, the device specified in this data sheet falls into the class **exempt group (exposure time 10000 s)**. Under real circumstances (for exposure time, conditions of the eye pupils, observation distance), it is assumed that no endangerment to the eye exists from these devices. As a matter of principle, however, it should be mentioned that intense light sources have a high secondary exposure potential due to their blinding effect. When looking at bright light sources (e.g. headlights), temporary reduction in visual acuity and afterimages can occur, leading to irritation, annoyance, visual impairment, and even accidents, depending on the situation.

Subcomponents of this device contain, in addition to other substances, metal filled materials including silver. Metal filled materials can be affected by environments that contain traces of aggressive substances. Therefore, we recommend that customers minimize device exposure to aggressive substances during storage, production, and use. Devices that showed visible discoloration when tested using the described tests above did show no performance deviations within failure limits during the stated test duration. Respective failure limits are described in the IEC60810.

OSRAM Opto Semiconductors declares that this product contains DEHP (Diethylhexylphthalat) CAS 117-81-7 above the current RoHS and REACH SVHC limit of 0.1%. A full Product Material Data Sheet (MDS) is available on request.

Packing information is available on the internet (online product catalog).

For further application related information please visit [www.osram-os.com/appnotes](http://www.osram-os.com/appnotes)

## Disclaimer

### Attention please!

The information describes the type of component and shall not be considered as assured characteristics. Terms of delivery and rights to change design reserved. Due to technical requirements components may contain dangerous substances.

For information on the types in question please contact our Sales Organization.

If printed or downloaded, please find the latest version on the OSRAM OS website.

### Packing

Please use the recycling operators known to you. We can also help you – get in touch with your nearest sales office. By agreement we will take packing material back, if it is sorted. You must bear the costs of transport. For packing material that is returned to us unsorted or which we are not obliged to accept, we shall have to invoice you for any costs incurred.

### Product and functional safety devices/applications or medical devices/applications

OSRAM OS components are not developed, constructed or tested for the application as safety relevant component or for the application in medical devices.

OSRAM OS products are not qualified at module and system level for such application.

In case buyer – or customer supplied by buyer – considers using OSRAM OS components in product safety devices/applications or medical devices/applications, buyer and/or customer has to inform the local sales partner of OSRAM OS immediately and OSRAM OS and buyer and /or customer will analyze and coordinate the customer-specific request between OSRAM OS and buyer and/or customer.

## Glossary

- 1) **Photocurrent:** The photocurrent values are measured (by irradiating the devices with a homogenous light source and applying a voltage to the device) with a tolerance of  $\pm 11\%$ .
- 2) **Typical Values:** Due to the special conditions of the manufacturing processes of semiconductor devices, the typical data or calculated correlations of technical parameters can only reflect statistical figures. These do not necessarily correspond to the actual parameters of each single product, which could differ from the typical data and calculated correlations or the typical characteristic line. If requested, e.g. because of technical improvements, these typ. data will be changed without any further notice.
- 3) **Testing temperature:**  $T_A = 25^\circ\text{C}$  (unless otherwise specified)
- 4) **Tolerance of Measure:** Unless otherwise noted in drawing, tolerances are specified with  $\pm 0.1$  and dimensions are specified in mm.

---

## Revision History

Version	Date	Change
1.4	2019-06-24	Disclaimer
1.5	2019-07-10	Notes
1.6	2020-06-09	Not for new design
1.7	2020-10-07	Characteristics



