

AN-REF-ICL8201_GU10

7.5W 180mA Single Stage Floating Buck LED (GU10) Converter with ICL8201 & IPU50R3K0CE

Application Note

About this document

Scope and purpose

This document is an universal 7.5W 180mA average current controlled single stage, cascode structure for floating bulk topology GU10 LED lamp reference design using Infineon LED driver ICL8201 (SOT23-6-1) and CoolMOS™ IPU50R3K0CE (IPAK). It has high efficiency, high PFC and various modes of protections with very low external component count. ICL8201 concept supports simple buck inductor without auxiliary winding.

Intended audience

This document is intended for users of ICL8201 who wish to design very low cost, high efficiency and power factor in GU10 form factor LED lamp.

Table of Contents

Table of Contents.....	2
1 Introduction.....	3
2 Reference board.....	3
3 Specification.....	3
4 Schematic.....	4
5 GU10 reference board layout.....	4
6 Bill of material and transformer specification.....	5
6.1 Bill of material.....	5
6.2 Transformer specification.....	6
7 Single stage power factor correction.....	6
8 Protection functions.....	7
9 Reference board set up, test waveforms and results.....	8
9.1 Input and output.....	8
9.2 Start up.....	8
9.3 Switching waveform.....	9
9.4 Output waveform.....	10
9.5 Input waveform.....	11
9.6 Protection waveforms and results (Short output, Short winding, Intelligent over temperature protection).....	12
9.6.1 Short output protection.....	12
9.6.2 Short winding protection.....	13
9.6.3 Intelligent over temperature protection.....	14
9.7 Test results (Power factor, Total Harmonic Distortion (THD), Efficiency, Regulation, Conducted Emissions&Lightning surge).....	15
9.7.1 Power Factor and Total Harmonics Distortion.....	16
9.7.2 Output current regulation.....	16
9.7.3 Efficiency.....	17
9.7.4 Conducted emissions (EN55015).....	18
9.7.5 Lightning Surge (EN61000-4-5).....	20
10 References.....	21
Revision History.....	21

Introduction

1 Introduction

This application note is an engineering report of GU10 LED lamp reference design for universal input 7.5W 180mA converter. The converter is using ICL8201 (SOT23-6-1), average current controlled, non-isolated single stage buck topology in cascode structure LED driver and IPU50R3K0CE (IPAK), a CE series of high voltage power CoolMOS™. With this cascode structure, system can achieve fast IC start up without the need to use a costly depletion MOSFET or alternatively a low cost start up resistor that causes continuous power losses during normal operation. This reference design is a single stage design with high efficiency and power factor, critical conduction operation mode with single choke(without auxiliary winding), truly regulated output current over a wide input and output voltage range, good EMI performance and various modes of protections for high reliability with minimum external components.

2 Reference board

This document contains the list of features, the power supply specification, schematic, bill of material and the transformer construction documentation. Typical operating characteristics such as performance curve and scope waveforms are shown at the rear of the report.

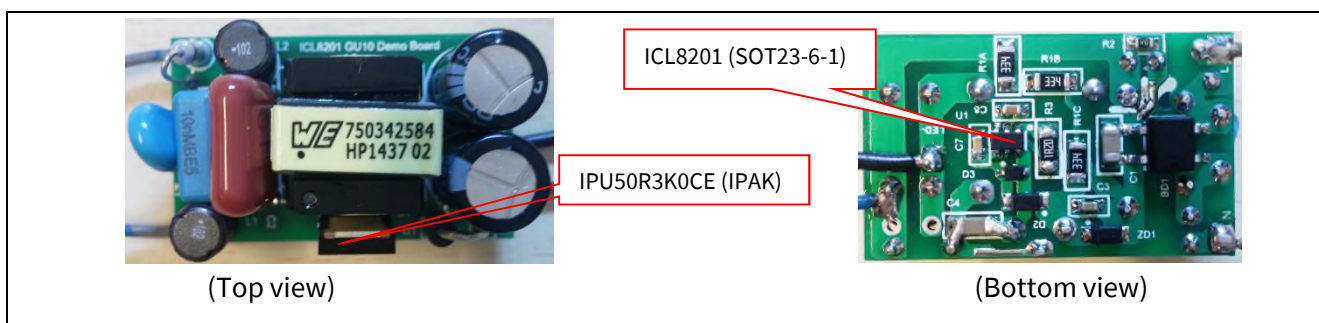

Figure 1 REF-ICL8201_GU10 [Size(L x W x H): 33mm x 20mm x 18mm]

3 Specification

Table 1 Specification of REF-ICL8201_GU10

Input voltage & frequency	90V _{AC} ~265V _{AC} (60/50Hz)
Output voltage, current & power	33V~47V, 180mA, 7.5W
Power factor	>0.95 @ low line >0.80 @ high line
THD	< 20% @ low line < 30% @ high line
Efficiency	>85%
Conducted emissions (EN55015)	Pass

Note: The PF and THD can be further optimized if this is the narrow range Vin design.

4 Schematic

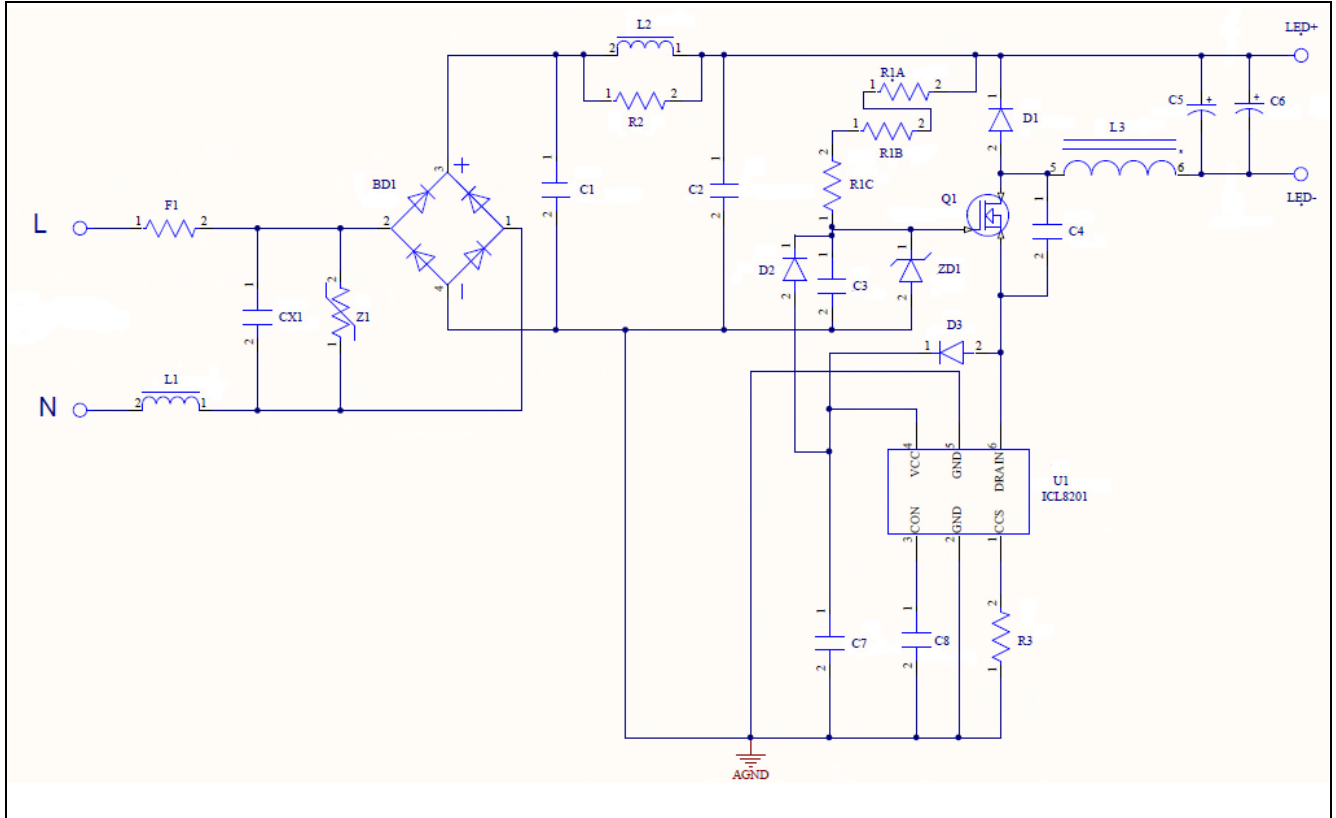

Figure 2 Schematic of REF-ICL8201_GU10

5 GU10 reference board layout

The reference board has double layers PCB with dimension of 33x20mm and thickness of 0.8mm is used. The maximum height of the demo board is 18mm. With its compact form factor, this reference board is able to fit into GU10 lamp.

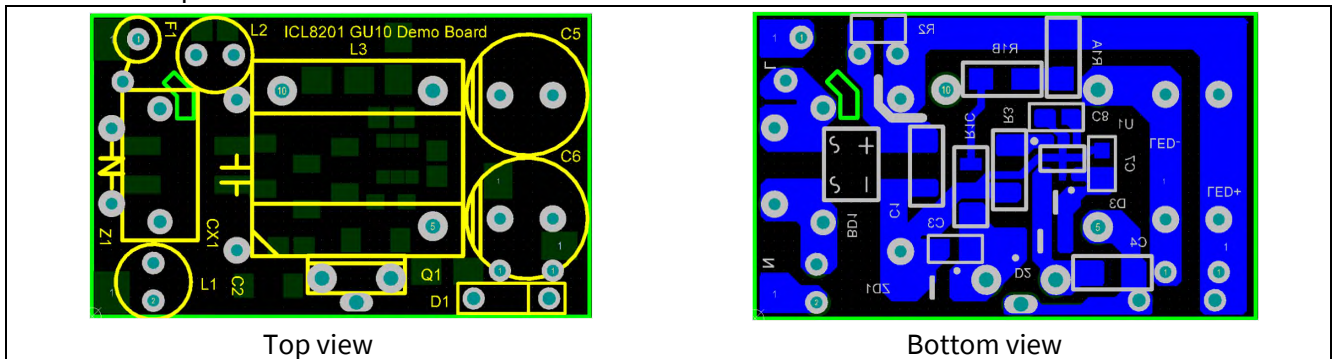

Figure 3 Top and bottom view

BOM

6 Bill of material and transformer specification

6.1 Bill of material

Table 2 ICL8201 (GU10) BOM Rev.A

No.	Designator	Name	Manufacturer	Part Number	Description	QTY
1	BD1	Bridge Rectifier	VISHAY GENERAL	MB6S-E3/80	BRIDGE RECTIFIER, 0.5A, 600V, SMD	1
2	C1	SMD Cap	MURATA	GRM31CR72J153KW03L	SMD, 1206, 15nF/630VDC	1
3	C2	Film Cap	PANASONIC	ECWF2W224JAQ	CAP, FILM, PP, 220NF, 450V, RAD	1
4	C3	SMD Cap	Yageo	CC0603KRX7R8BB103	CAP CER 10nF 25V 10% X7R 0603	1
5	C4	SMD Cap	MURATA	GRM31A5C2J101JW01D	MURATA, MLCC, X7R, 630V 100pF,1206	1
6	C5, C6	Alu Elec Cap	PANASONIC	EEUFR1H101	CAP, ALU ELEC, 100UF, 50V, RAD	2
7	C7	SMD Cap	MURATA	GRM188R61E225KA12D	CAP, MLCC, X5R, 2.2UF, 25V, 0603	1
8	C8	SMD Cap	MURATA	GRM188R71A225KE15D	CAP CER 2.2uF 10V 10% X7R 0603	1
9	CX1	Film Cap	Kemet	PHE840MK5100MK01R17	Film Capacitors 275volts 0.010uF 20% LS=7.5mm	1
10	D1	Switching Diode	ON Semi	MUR160G	DIODE, ULTRA-FAST, 1A, 600V, DO-15	1
11	F1	Fuse	Vishay	NFR25H0001008JA500	RES, METAL FILM, 1R, 5%, 500MW, AXIAL	1
12	L1, L2	FILTER_CHOKE	Wurth	7447462102	Wurth INDUCTOR, AXIAL 1.0MUH, 250mA	2
13	L3	Main CHOKE	Wurth	750342584	EE13; 600uH, ±10%	1
14	Q1	Mosfet	Infineon	IPU50R3K0CE	500V, 1.7A, 3.0ohm, I-PAK	1
15	R1A, R1B, R1C	SMD Resistor	Yageo	RV1206JR-07330KL	RES SMD 330K OHM 1/4W 5% 1206	3
16	R3	SMD Resistor	VISHAY DALE	CRCW12061R10FNEA	RES SMD 1.2 OHM 1/4W 1% 1206	1
17	R2	SMD Resistor	BOURNS	CR0603-JW-472ELF	RESISTOR, 0603, 4.7K, 5%, 0.1W	1
18	U1	IC	Infineon	ICL8201	LED Buck Controller, SOT23-6-1	1
19	Z1	VARISTOR5	Multicomp	MCV471K05DS	VARISTOR, 775, 5mm DISC	1
20	ZD1	Zener Diode	ON Semi	MMSZ5242BT1G	DIODE ZENER 15V 500MW SOD123	1
21	D2	Switching Diode	MULTICOMP	1N4148W	SMALL SIGNAL, 75V, SOD-123F	1
22	D3	Switching Diode	Micro Commercial	1N4148WX-TP	SWITCHING DIODE, 300mA, 100V, SOD323	1

7.5W 180mA Single Stage Floating Buck LED (GU10) Converter with ICL8201 & IPU50R3K0CE



Transformer specification and Single stage PFC

6.2 Transformer specification

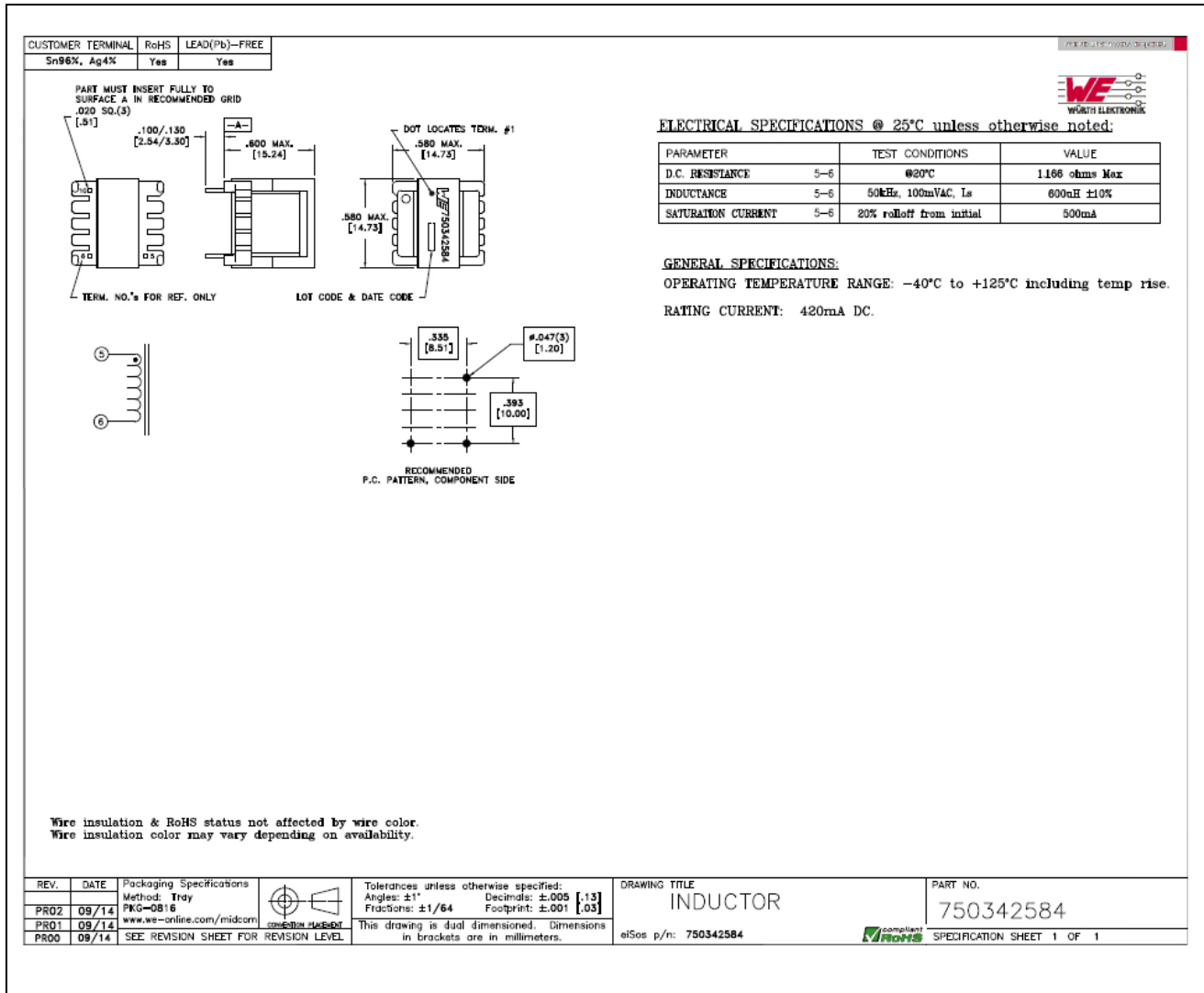

Figure 4 Transformer structure

7 Single stage power factor correction

Single stage power factor correction (PFC) zero current detection bulk helps realising highly efficient, cost effective and compact LED driver design. In this reference board, ICL8201 achieves the single stage power factor correction by fixing on time over half AC sinusoidal cycle waveform.

As can be noted from below picture, the averaged input current is shaped to be approximately sinusoidal and thus high power factor is achieved with input current harmonics fulfilling the requirements of EN 61000-3-2 standard.

Protection functions

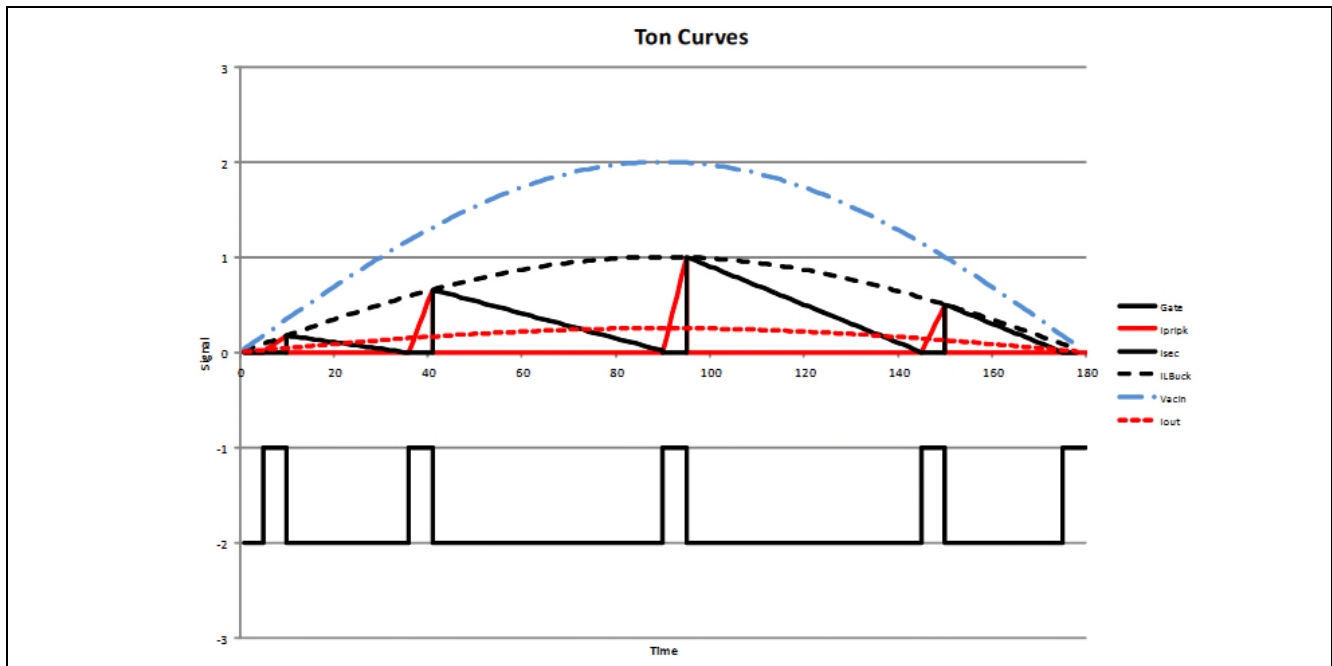

Figure 5 Voltage and current waveforms in half AC cycle

8 Protection functions

The protection functions of ICL8201 are listed below.

Table 3 ICL8201 protection functions

VCS Short (Pin 1) to GND	Latch
VCS Open (Pin 1)	Latch
VCon Short (PIN 3) to GND	Latch
VCon OPEN (PIN 3)	Latch
Short OUTPUT	Latch
Short Winding (Main Choke)	Latch
Intelligent Over Temperature Protection (iOTP)	Latch

9 Reference board set up, test waveforms and results

9.1 Input and output

The input of REF-ICL8201_GU10 is Live (L) and Neutral (N) wires and its operating input AC voltage range is $90V_{AC} \sim 265V_{AC}$.

The output of REF-ICL8201_GU10 is LED+ and LED- wires which can supply 40V, 180mA to the LED module.

Attention: As this is a non-isolated design, high voltage exists at the output! An isolated transformer is advised to be used during evaluating of this reference board.

9.2 Start up

When the AC input voltage is applied to the reference board, V_{CC} capacitor will be charged through external LED module, Buck choke (L3), external power switch (Q1) and V_{CC} diode (D3). Once the V_{CC} voltage reaches 7.5V, the IC will start switching with a digital soft start and enter into normal operation.

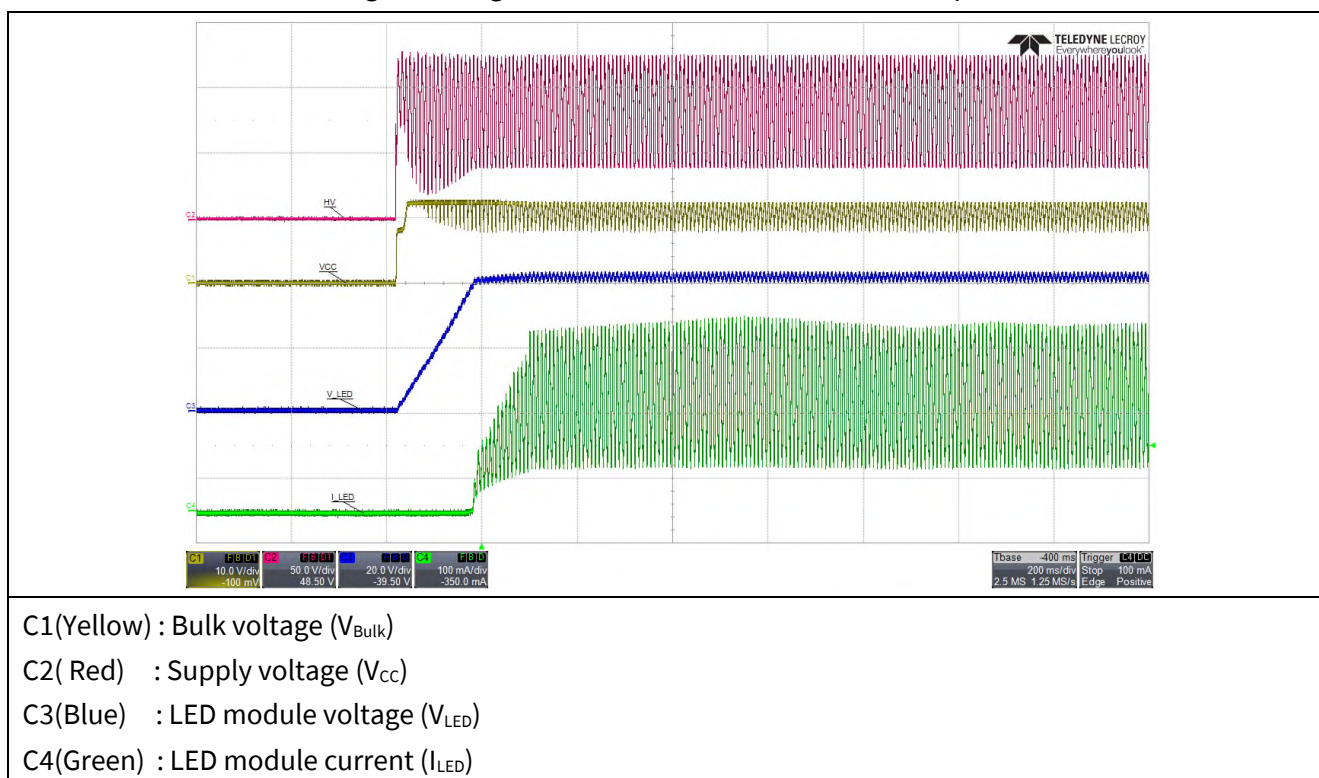

Figure 6 Start up waveform

9.3 Switching waveform

The current mode controller, ICL8201 uses zero current switching technique without zero crossing detection winding but by sensing the drain pin voltage of the controller. This helps to simplify the structure of the buck choke without auxiliary winding and improve both EMI and efficiency performance. Typical switching waveform of ICL8201 is as shown below.

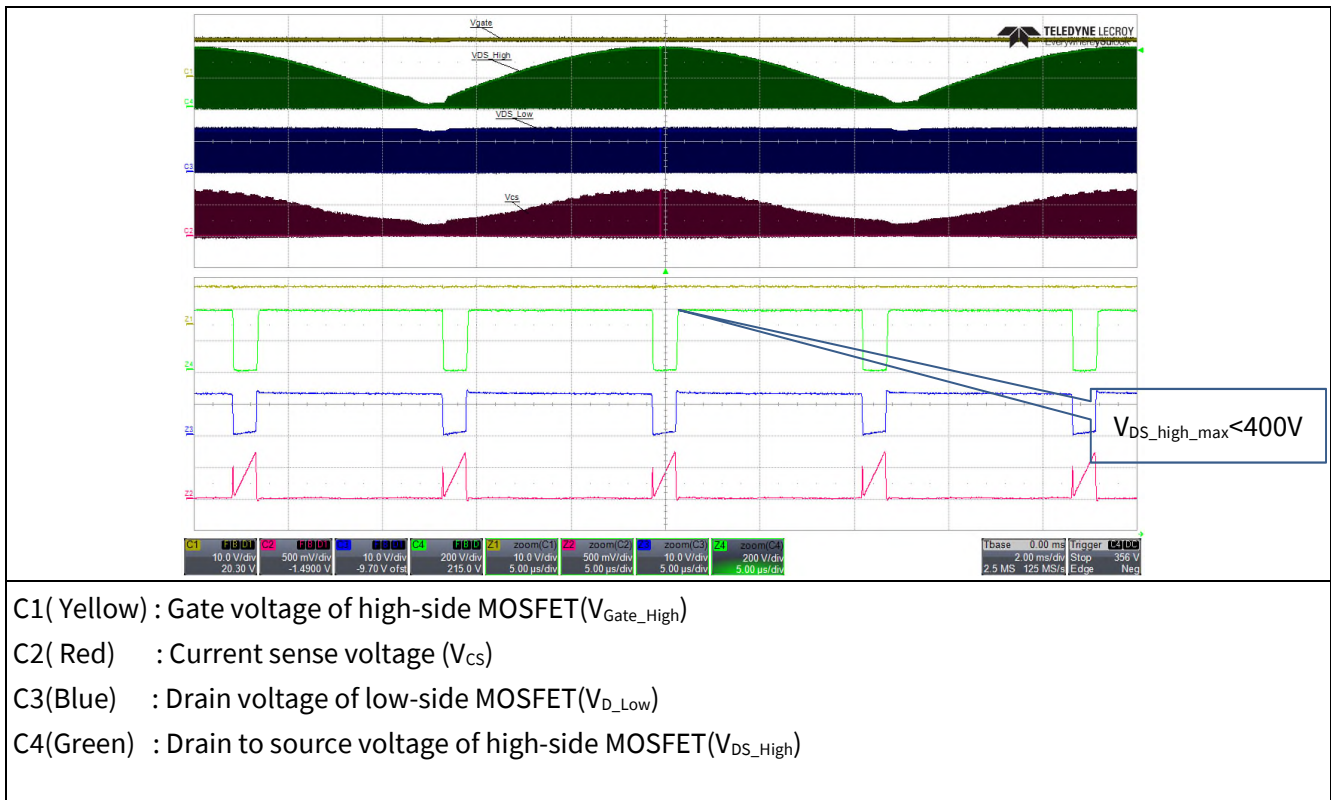

Figure 7 Switching waveform @ 265V_{AC} /50Hz

9.4 Output waveform

The output capacitor is sized for an output current ripple which exhibits no visible light modulation. The following figure shows the measured waveform of output voltage and current during normal operation at full load.

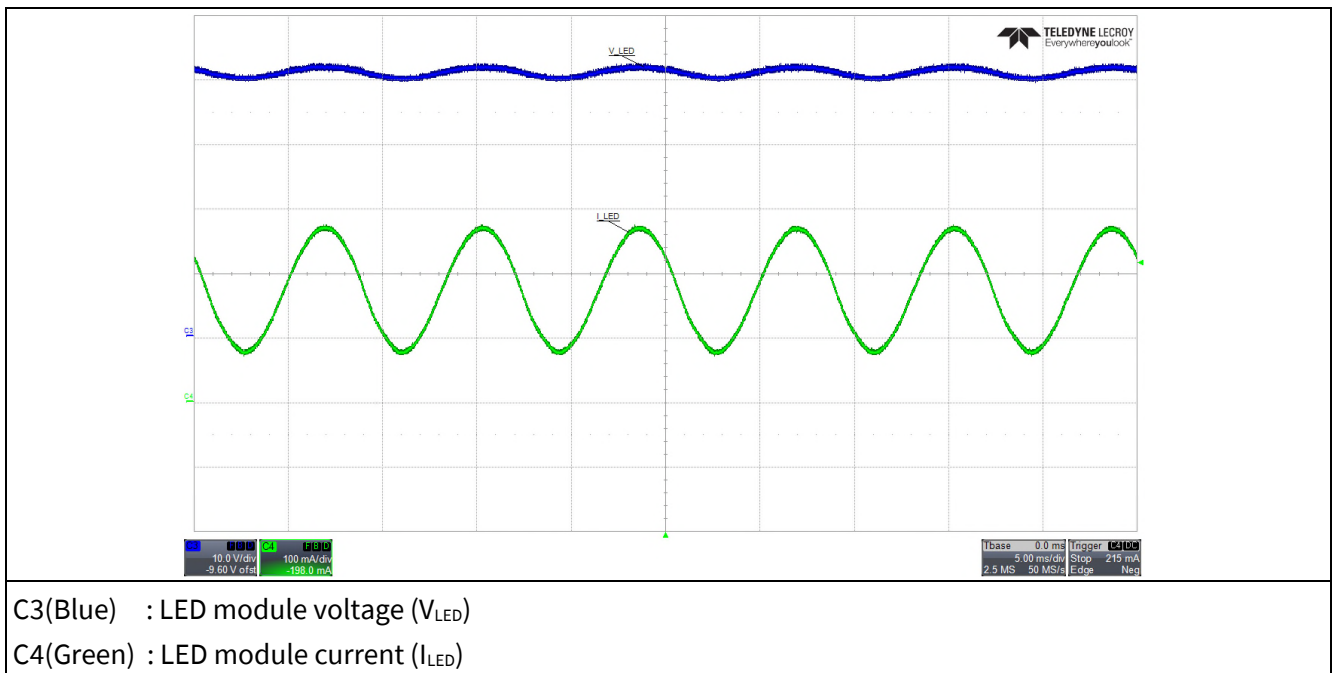

Figure 8 Output voltage and current @ 120V_{AC} /60Hz

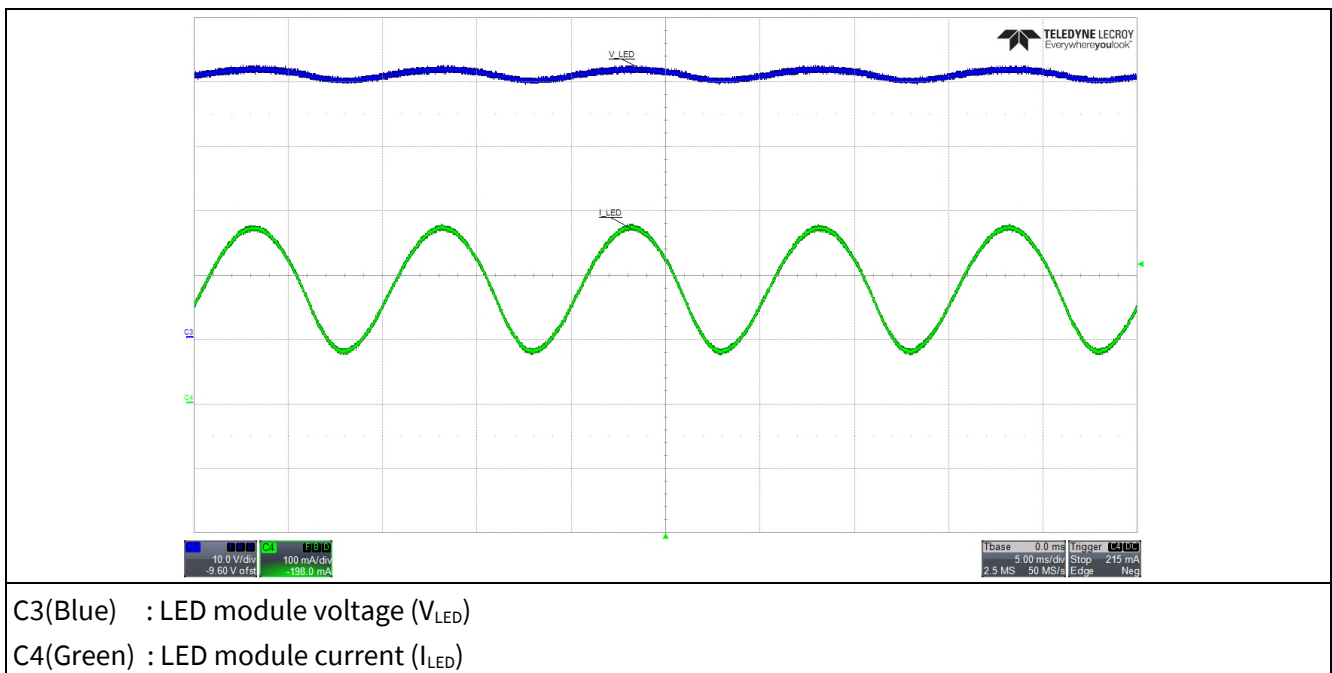

Figure 9 Output voltage and current @ 230V_{AC} /50Hz

9.5 Input waveform

Below figure shows the waveform of input voltage, current and the current sense pin voltage during normal operation at full load.

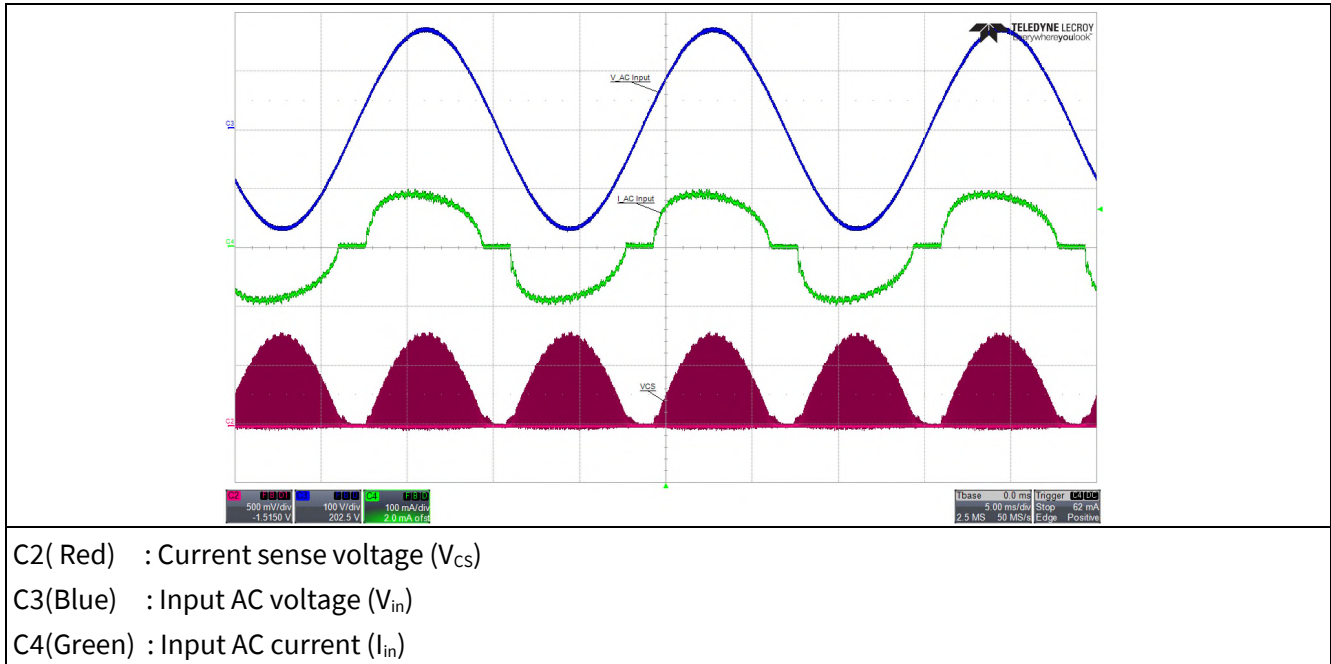

Figure 10 Input voltage and current @ 120V_{AC} /60Hz

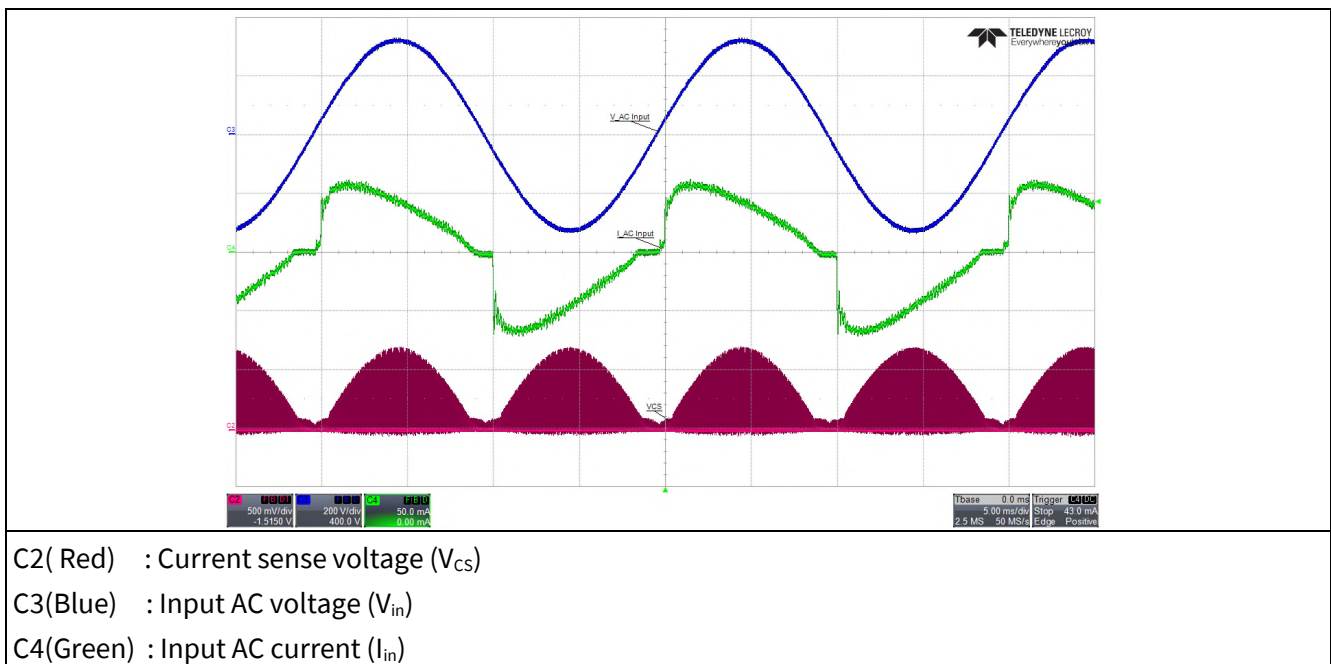
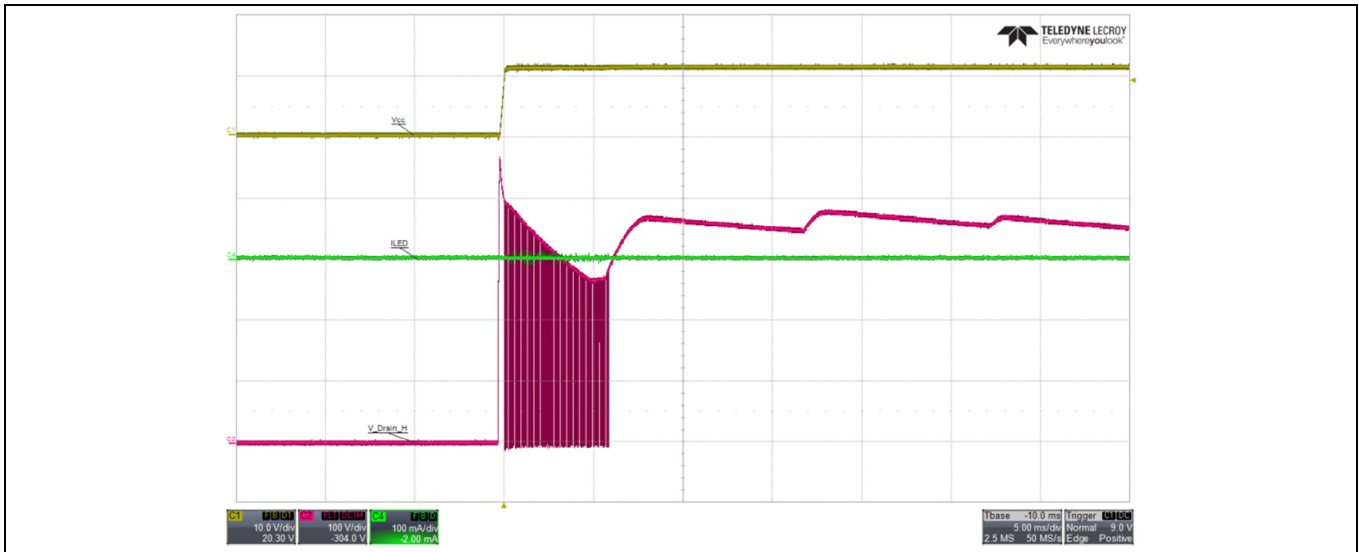

Figure 11 Input voltage and current @ 230V_{AC} /50Hz

9.6 Protection waveforms and results (Short output, Short winding, Intelligent over temperature protection)

9.6.1 Short output protection

The tested waveform at StartUp mode and Run Mode is shown as below, the system board enters to latch mode, and the power consumption is 0.26W @ Max Vin=265Vac/50Hz.



- C1 (Yellow) : Vcc voltage (V_{CC})
- C2 (Red) : High side MOSFET Drain voltage (V_{Drain_H})
- C4 (Green) : LED module current (I_{LED})

Figure 12 Waveform of StartUp Mode (40V, 180mA LED load@Vin=265V_{AC}/50Hz)

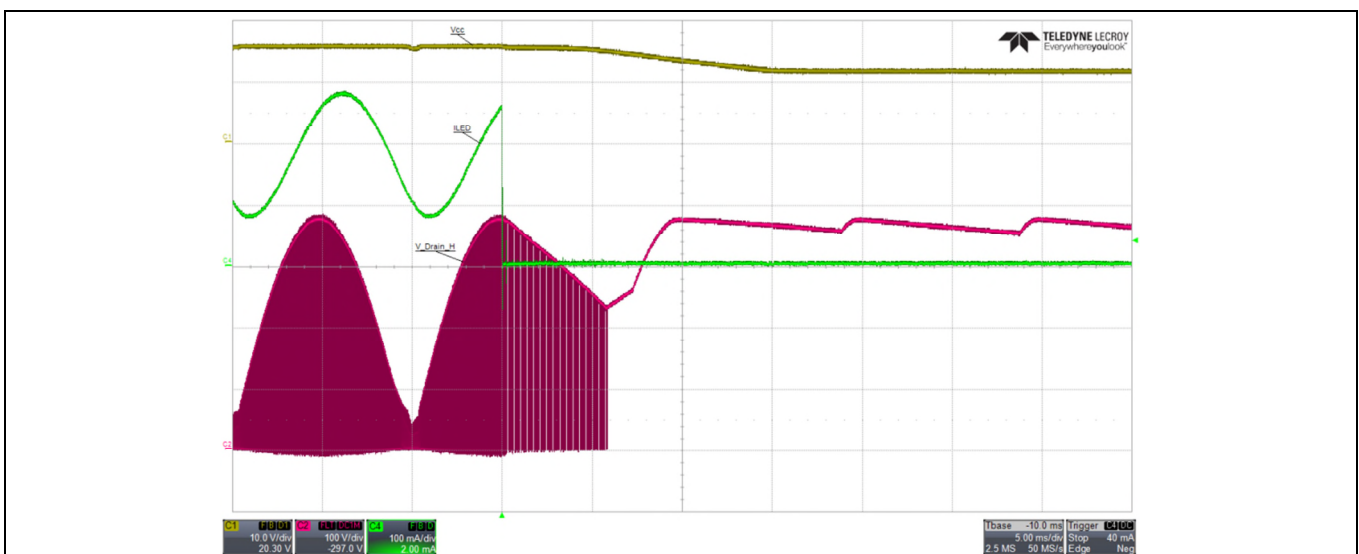

- C1 (Yellow) : Vcc voltage (V_{CC})
- C2 (Red) : High side MOSFET Drain voltage (V_{Drain_H})
- C4 (Green) : LED module current (I_{LED})

Figure 13 Waveform of Run Mode (40V, 180mA LED load@Vin=265V_{AC}/50Hz)

9.6.2 Short winding protection

Below figures show the waveforms of V_{CC} , LED output current and the Drain of high side MOSFET voltage during the short winding protection under StartUp and Run Mode. The system board enters to latch mode and the power consumption is 0.26W @ Max $V_{in} = 265V/50Hz$.

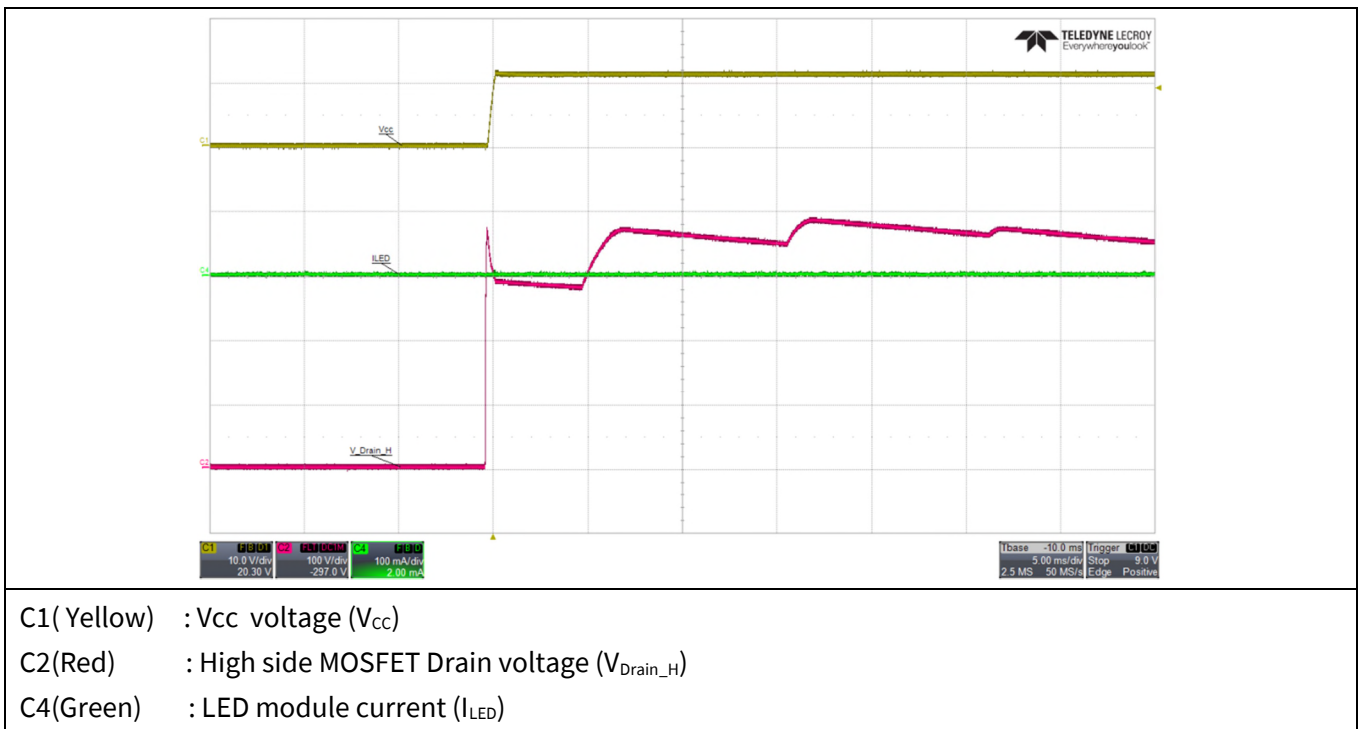

Figure 14 Waveform of StartUp Mode (40V, 180mA LED load@ $V_{in}=265V_{AC}/50Hz$)

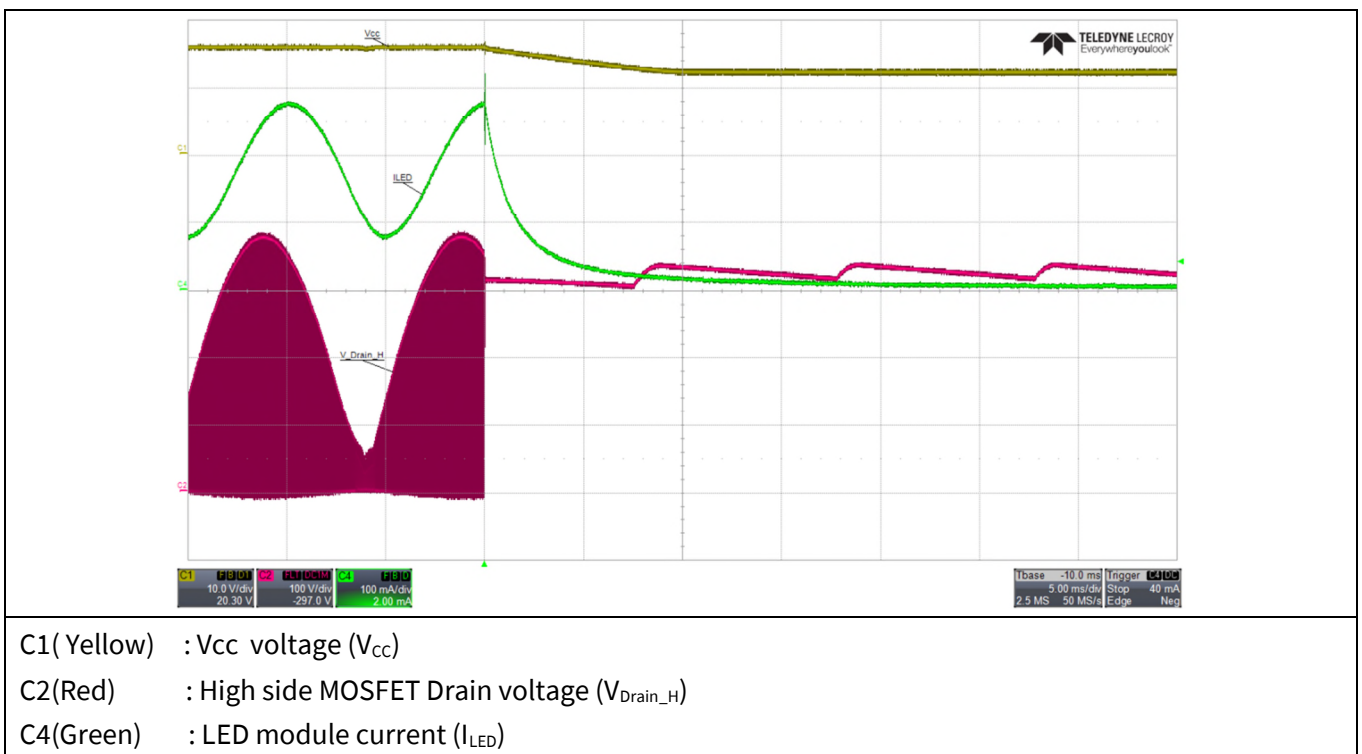

Figure 15 Waveform of Run Mode (40V, 180mA LED load@ $V_{in}=265V_{AC}/50Hz$)

9.6.3 Intelligent over temperature protection

ICL8201 has Intelligent over temperature protection shown as below (Figure 16). It reduces the output current in 7 digital steps down to 50% of target value of I_{LED} in the event of overheating IC ($T_j > 150^\circ\text{C}$). If the temperature continues to increase and exceeds $T_j > 160^\circ\text{C}$, the IC will enter LATCH OFF mode. Figure 17 is the real testing curve (I_{LED} vs. AMB) which is tested under the condition of putting GU10 board into oven. Measuring the I_{LED} corresponding to AMB (Ambient Temperature) from -25°C to $+135^\circ\text{C}$. GU10 board starts to reduce I_{LED} from $155\text{mA}@ \text{AMB}=125^\circ\text{C}$ to $76.7\text{mA}@ \text{AMB}=132.9^\circ\text{C}$ which is about 50% of 155mA . Continue to increase AMB, GU10 board enter to latch mode @ $\text{AMB}=135^\circ\text{C}$.

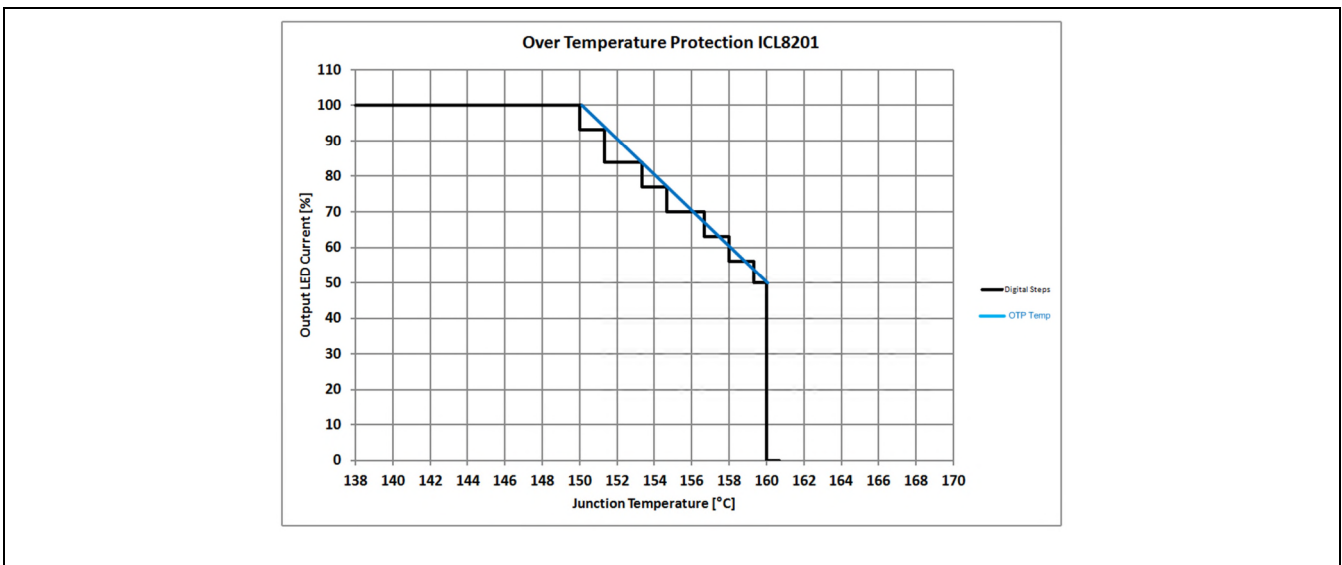

Figure 16 Standard curve of Intelligent Over-Temperature Protection (iOTP)

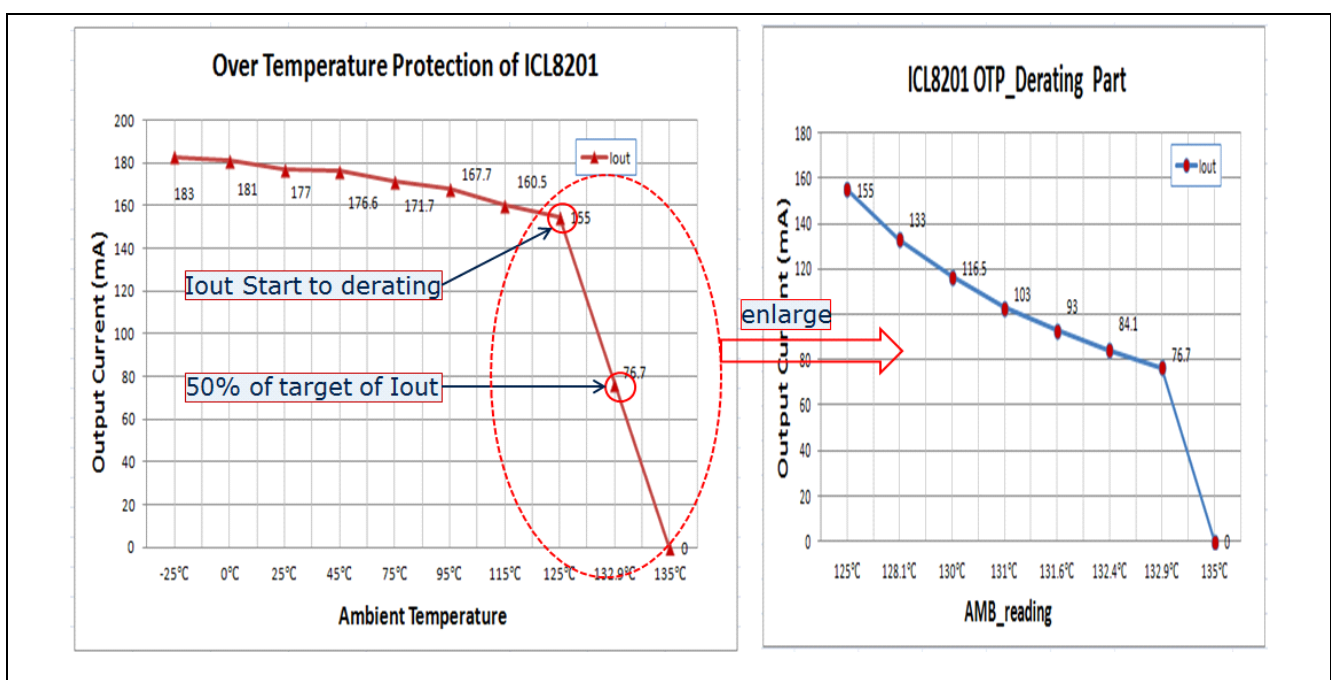

Figure 17 GU10 Board iOTP testing results (I_{LED} vs. AMB)

7.5W 180mA Single Stage Floating Buck LED (GU10) Converter with ICL8201 & IPU50R3K0CE



Reference board set up, test waveforms and results

9.7 Test results (Power factor, Total Harmonic Distortion (THD), Efficiency, Regulation, Conducted Emissions&Lightning surge)

Table 4 Power Factor, THD, Efficiency & Regulation

40V, 180mA LED load									
V _{in} & f _{in} (V _{AC} /Hz)	P _{in} (W)	PF	THD	V _{out} (V _{DC})	I _{out} (mA)	P _{out} (W)	ΔI _{out} (%)	Efficiency (%)	Average Efficiency (%)
90V/60Hz	7.88	0.98	17.45	41.4	175.5	7.27	-2.50	92.20	89.89
120V/60Hz	7.91	0.98	14.32	41.4	176	7.29	-2.22	92.12	
135V/60Hz	7.96	0.98	15.00	41.4	176	7.29	-2.22	91.54	
185V/50Hz	8.22	0.96	19.00	41.4	178	7.37	-1.11	89.65	
230V/50Hz	8.5	0.91	23.90	41.41	180	7.45	0.00	87.69	
265V/50Hz	8.75	0.87	27.40	41.42	182	7.54	1.11	86.15	
33V, 180mA LED load									
V _{in} & f _{in} (V _{AC} /Hz)	P _{in} (W)	PF	THD	V _{out} (V _{DC})	I _{out} (mA)	P _{out} (W)	ΔI _{out} (%)	Efficiency (%)	Average Efficiency (%)
90V/60Hz	6.33	0.99	14.00	33.1	174	5.76	-3.33	90.99	88.87
120V/60Hz	6.36	0.98	15.24	33.1	175	5.79	-2.78	91.08	
135V/60Hz	6.43	0.97	17.10	33.1	176	5.83	-2.22	90.60	
185V/50Hz	6.65	0.93	22.24	33.12	178	5.90	-1.11	88.65	
230V/50Hz	6.89	0.87	27.23	33.14	180	5.97	0.00	86.58	
265V/50Hz	7.11	0.82	30.80	33.15	183	6.07	1.67	85.32	
47V, 180mA LED load									
V _{in} & f _{in} (V _{AC} /Hz)	P _{in} (W)	PF	THD	V _{out} (V _{DC})	I _{out} (mA)	P _{out} (W)	ΔI _{out} (%)	Efficiency (%)	Average Efficiency (%)
90V/60Hz	8.93	0.98	20.80	46.9	175	8.21	-2.78	91.91	90.45
120V/60Hz	8.9	0.98	15.05	46.9	175	8.21	-2.78	92.22	
135V/60Hz	8.95	0.98	14.70	46.9	176	8.25	-2.22	92.23	
185V/50Hz	9.25	0.97	17.40	46.9	178	8.35	-1.11	90.25	
230V/50Hz	9.55	0.93	21.95	46.91	181	8.49	0.56	88.91	
265V/50Hz	9.85	0.89	25.42	46.93	183	8.59	1.67	87.19	

9.7.1 Power Factor and Total Harmonics Distortion

The measured power factor and total harmonics distortion (THD) at different input voltages is as shown below. The power factor is >0.95 @ low line and >0.80 @ high line. THD is less than 30% over the whole input voltage range.

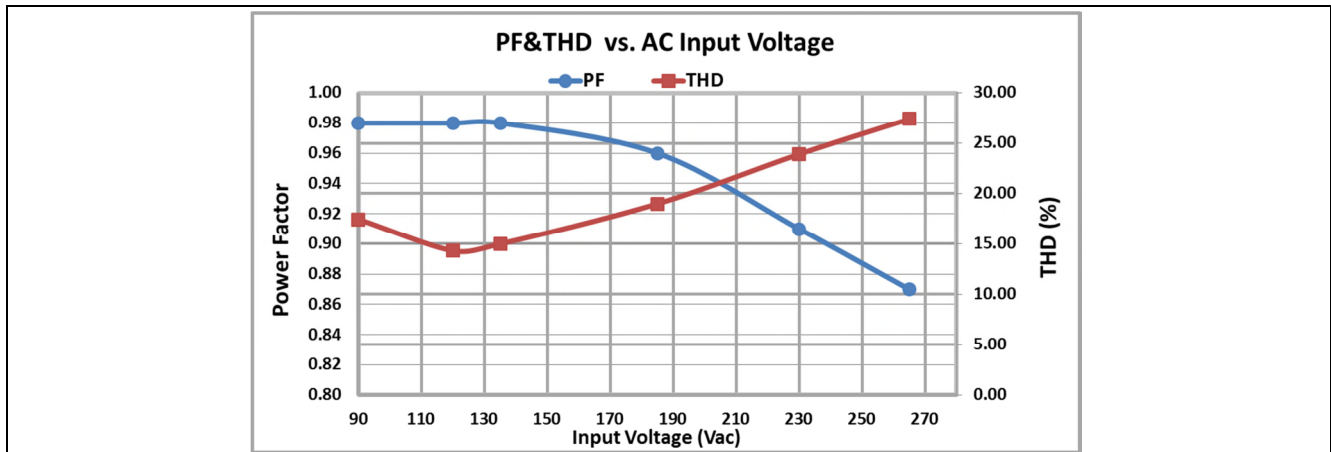

Figure 18 Power Factor and THD versus AC line voltage (40V, 180mA LED load)

9.7.2 Output current regulation

Below figure shows the LED output current versus line voltage. The output current is regulated within $\pm 3.5\%$ over the whole input voltage range.

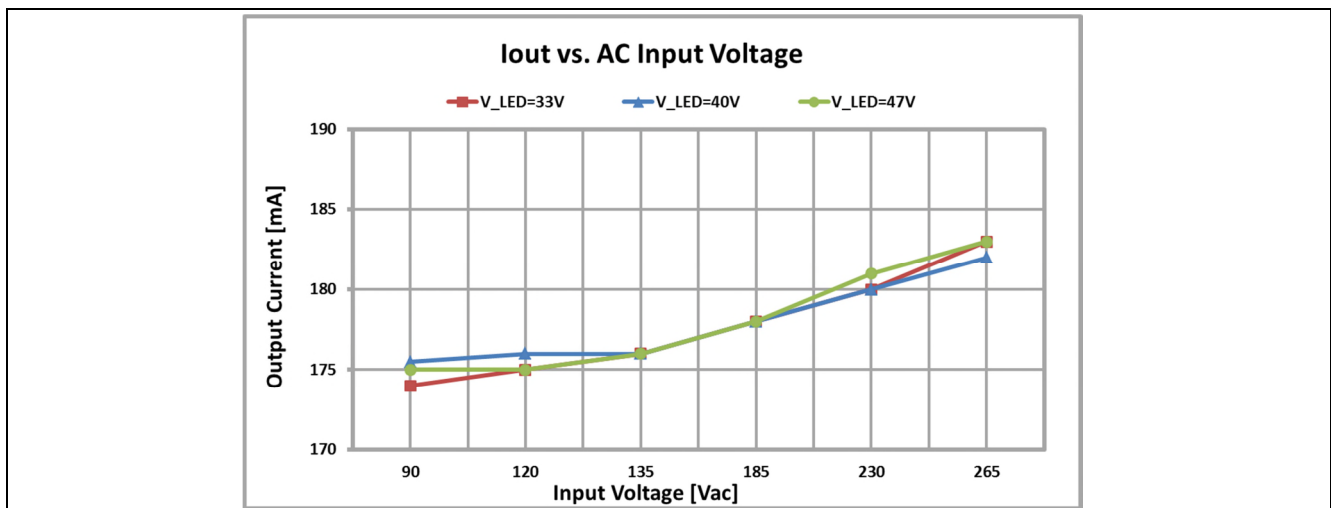

Figure 19 Output current versus AC line voltage

The following figure shows the LED output current versus output voltage (LED module's forward voltage). With the number of different LED changes, which corresponding to forward voltage of 33V, 40V and 47V, the output current is regulated within $\pm 1\%$.

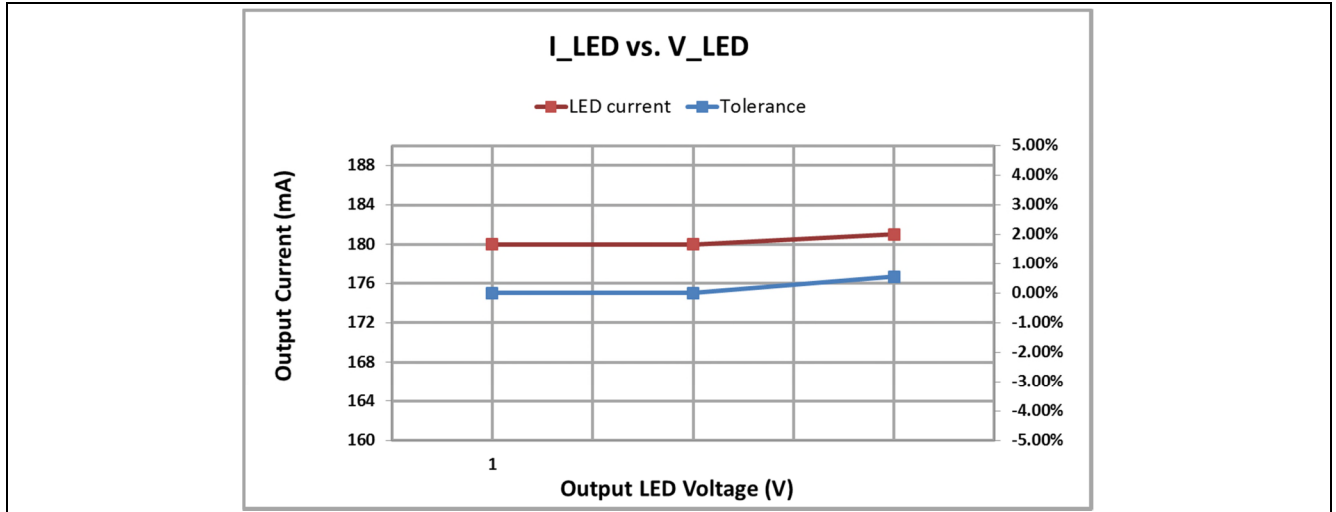

Figure 20 Output current versus output voltage ($V_{in}=230V_{AC}$, 50Hz)

9.7.3 Efficiency

The following figure shows the efficiency verses AC line voltage which exhibits >85% over the whole AC input range due to zero current turn on operation.

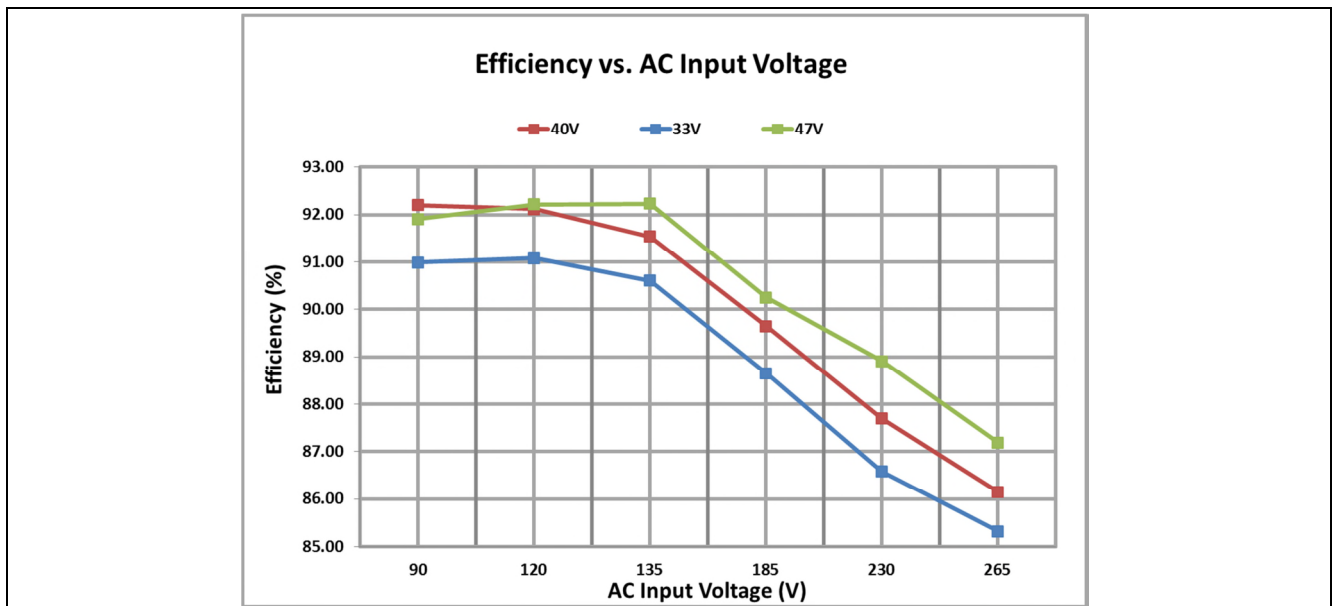

Figure 21 Efficiency versus AC line voltage

9.7.4 Conducted emissions (EN55015)

The conducted emissions test was performed at full load and there is approximately 2dB margin observed for both line and neutral measurements.

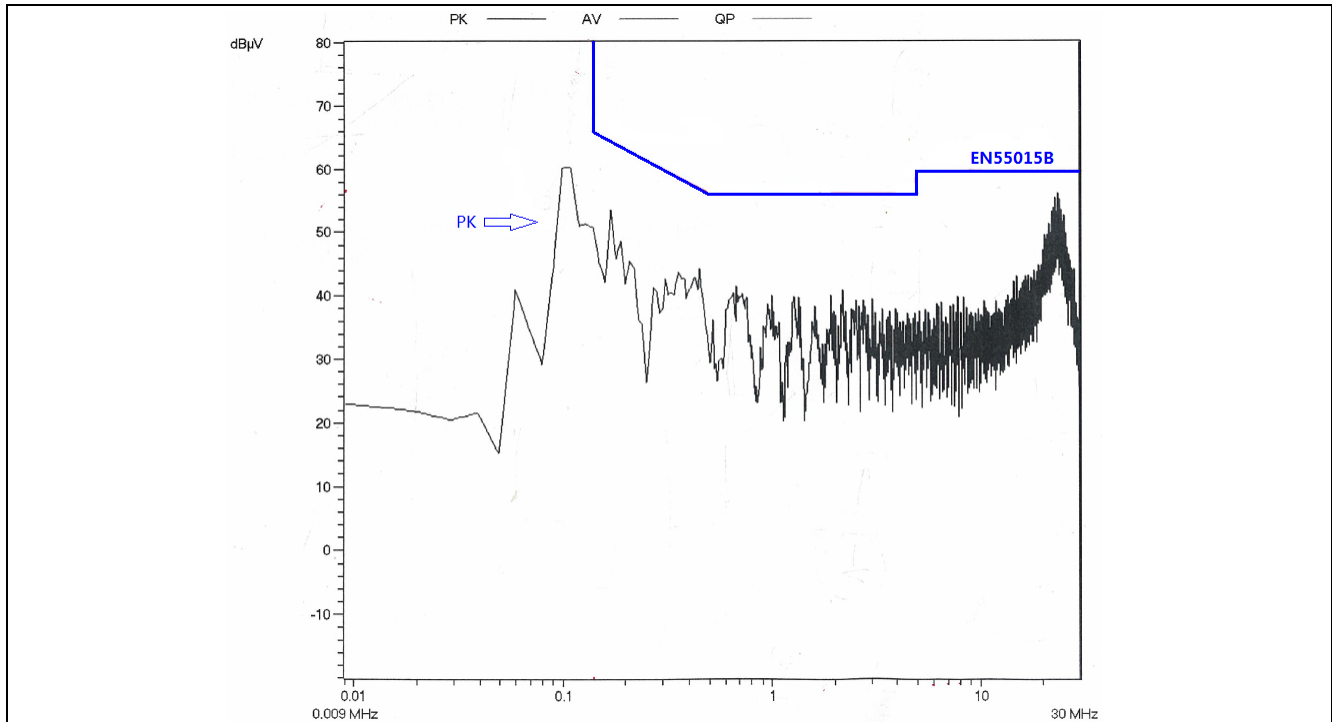

Figure 22 Conducted emissions(Line) at 110V_{AC}, 60Hz & full load

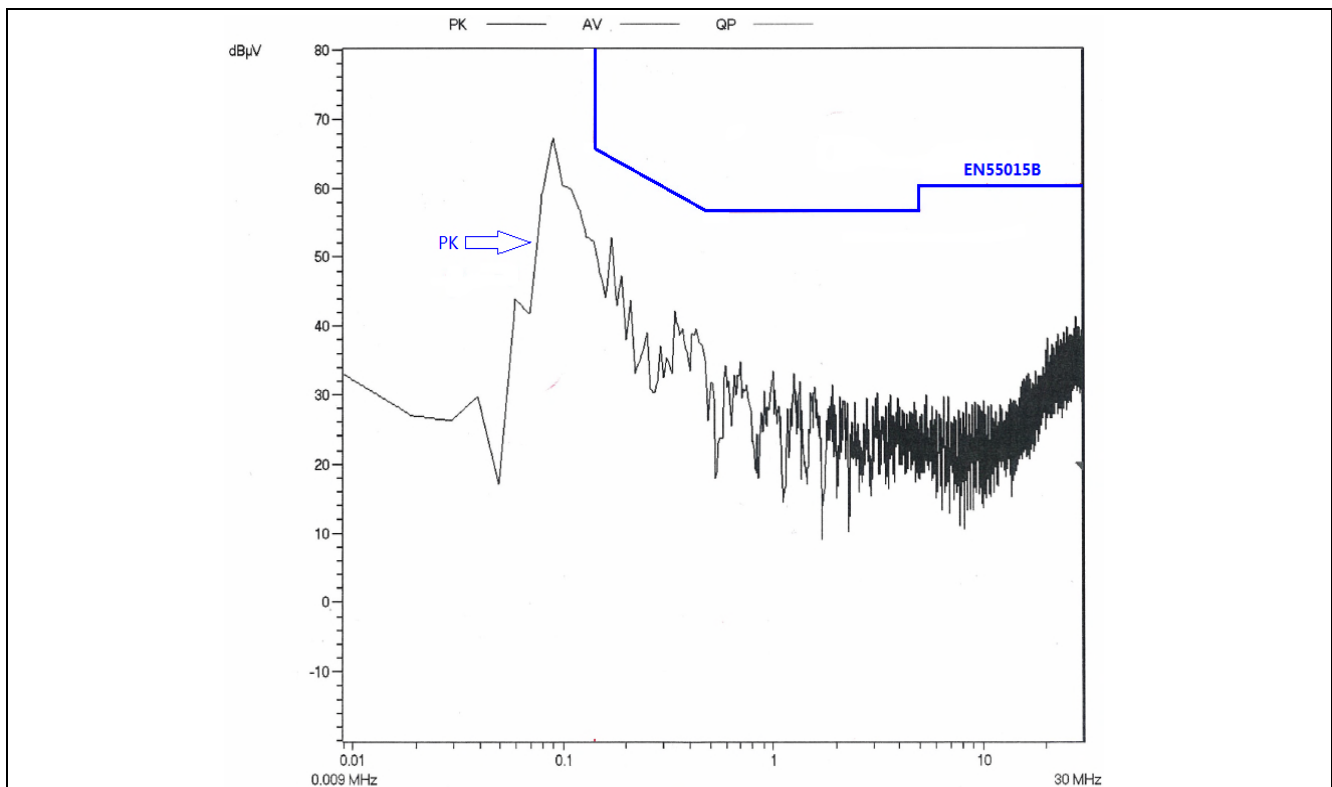

Figure 23 Conducted emissions(Neutral) at 110V_{AC}, 60Hz & full load

7.5W 180mA Single Stage Floating Buck LED (GU10) Converter with ICL8201 & IPU50R3K0CE



Reference board set up, test waveforms and results

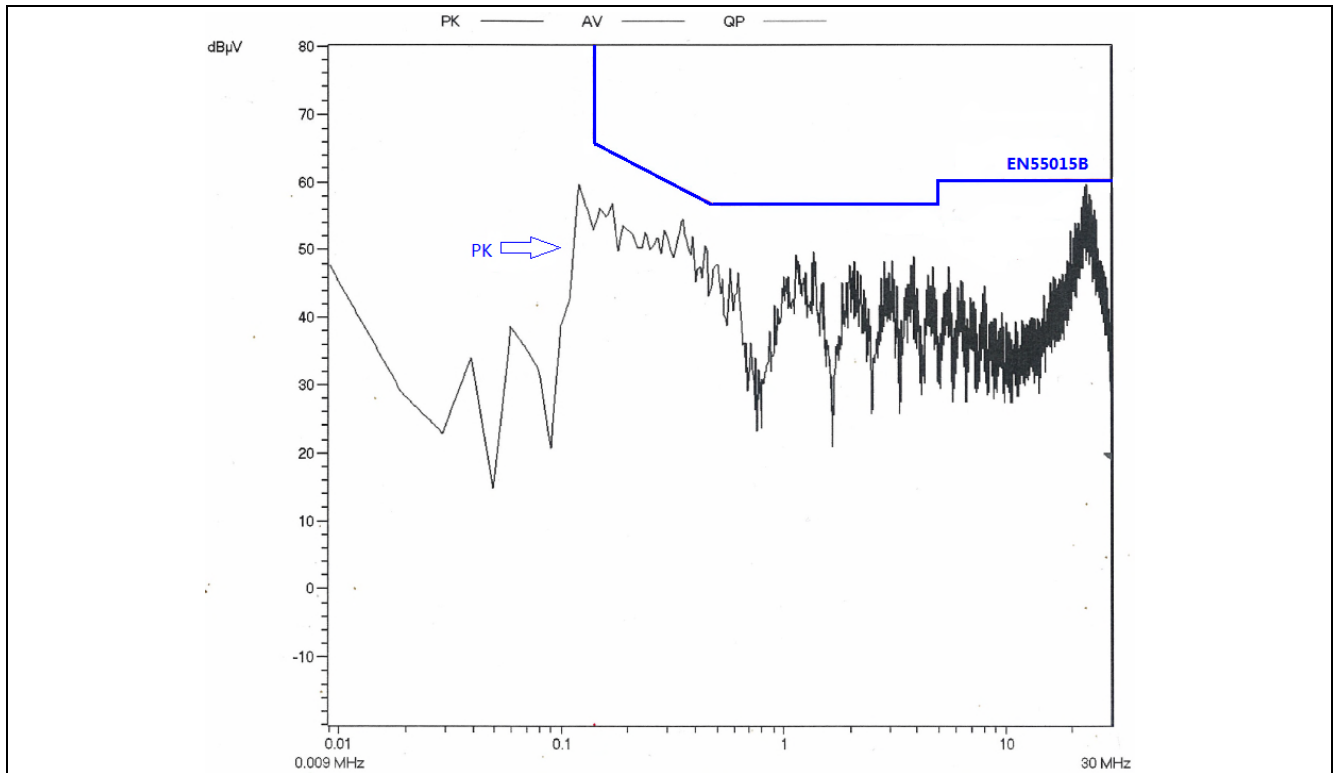

Figure 24 Conducted emissions(Line) at 230V_{AC}, 50Hz & full load

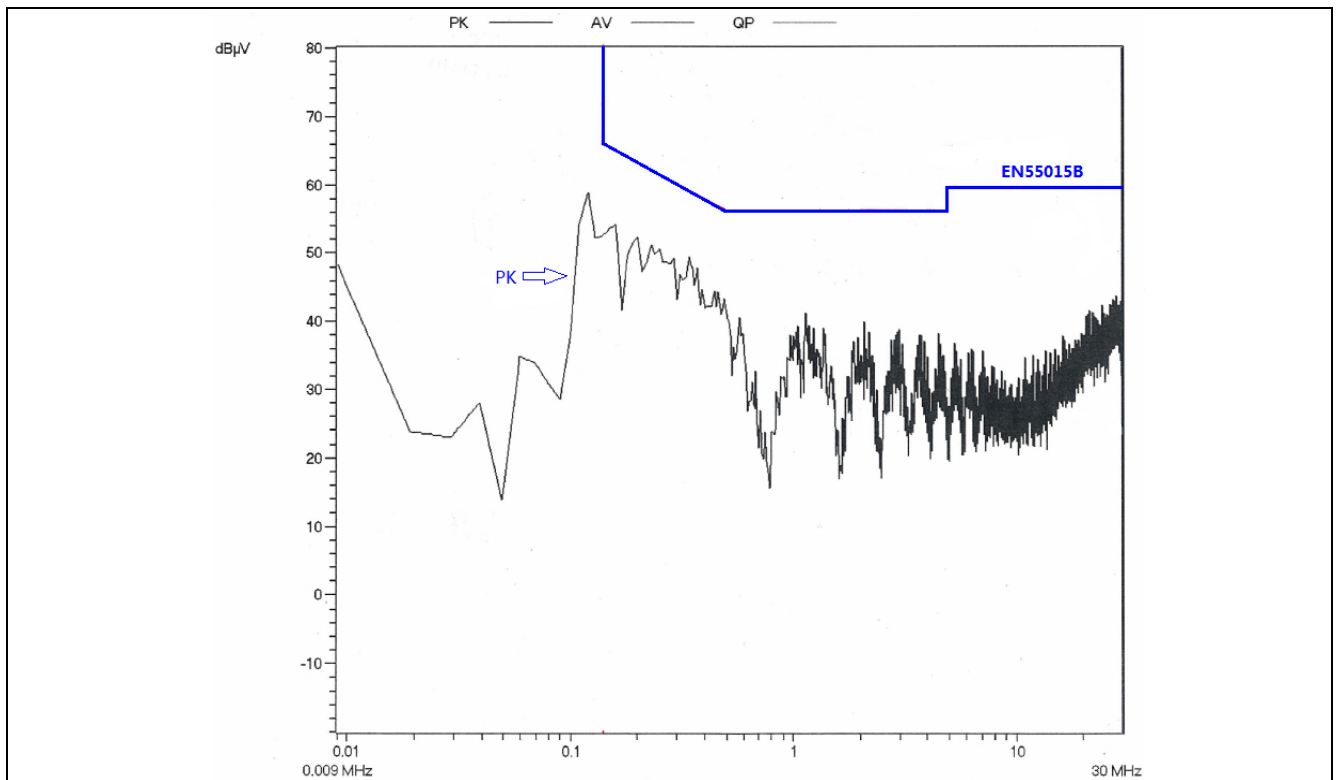

Figure 25 Conducted emissions(Neutral) at 230V_{AC}, 50Hz & full load

7.5W 180mA Single Stage Floating Buck LED (GU10) Converter with ICL8201 & IPU50R3K0CE



Reference board set up, test waveforms and results

9.7.5 Lightning Surge (EN61000-4-5)

The Board was subjected to $\pm 500V$ differential mode combination wave surge at 230Vac and full load using 5 strikes at each condition, and there was not any nonrecoverable interruption of output requiring supply repair or recycling of input voltage.

Table 5 Testing Results

Level (V)	Input Voltage (V)	Injection Location	Injection Phase (°)	Type	Test Results (Pass /Fail)
+500V	230	L, N	0	Surge (2 Ω)	PASS
-500V	230	L, N	0	Surge (2 Ω)	PASS
+500V	230	L, N	90	Surge (2 Ω)	PASS
-500V	230	L, N	90	Surge (2 Ω)	PASS
+500V	230	L, N	180	Surge (2 Ω)	PASS
-500V	230	L, N	180	Surge (2 Ω)	PASS
+500V	230	L, N	270	Surge (2 Ω)	PASS
-500V	230	L, N	270	Surge (2 Ω)	PASS

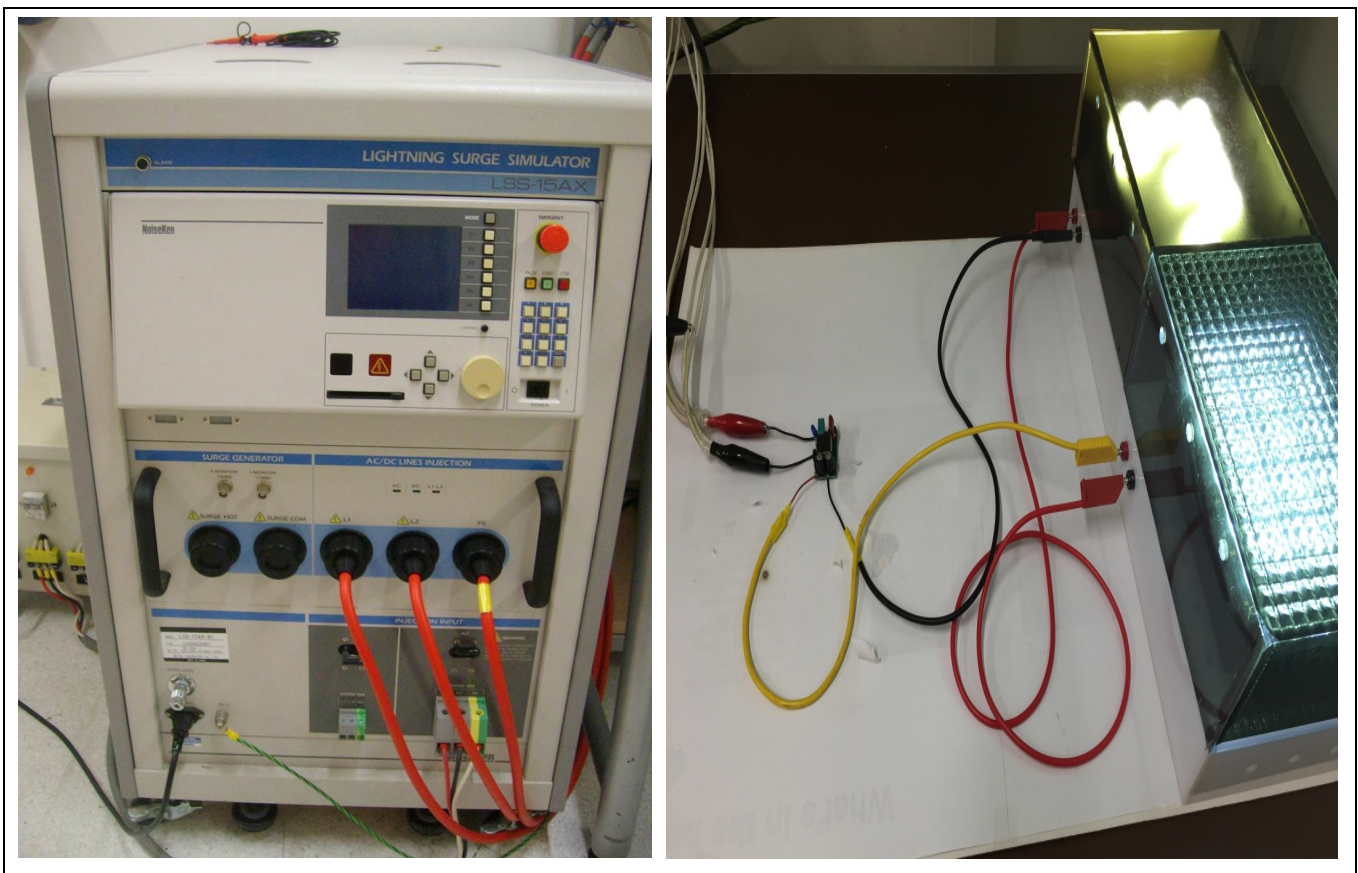

Figure 26 Testing Setup

References

10 References

- [1] ICL8201 data sheet, Infineon Technologies AG

Revision History

Major changes since the last revision

Page or Reference	Description of change

Trademarks of Infineon Technologies AG

AURIX™, C166™, CanPAK™, CIPOS™, CIPURSE™, CoolMOS™, CoolSET™, CORECONTROL™, CROSSAVE™, DAVE™, DI-POL™, EasyPIM™, EconoBRIDGE™, EconoDUAL™, EconoPIM™, EconoPACK™, EiceDRIVER™, eupec™, FCOS™, HITFET™, HybridPACK™, I²RF™, ISOFACE™, IsoPACK™, MIPAQ™, ModSTACK™, my-d™, NovalithIC™, OptiMOS™, ORIGA™, POWERCODE™, PRIMARION™, PrimePACK™, PrimeSTACK™, PRO-SIL™, PROFET™, RASIC™, Reversave™, SatRIC™, SIEGET™, SINDRION™, SIPMOS™, SmartLEWIS™, SOLID FLASH™, TEMPFET™, thinQ™, TRENCHSTOP™, TriCore™.

Other Trademarks

Advance Design System™ (ADS) of Agilent Technologies, AMBA™, ARM™, MULTI-ICE™, KEIL™, PRIMECELL™, REALVIEW™, THUMB™, μVision™ of ARM Limited, UK. AUTOSAR™ is licensed by AUTOSAR development partnership. Bluetooth™ of Bluetooth SIG Inc. CAT-iq™ of DECT Forum. COLOSSUS™, FirstGPS™ of Trimble Navigation Ltd. EMV™ of EMVCo, LLC (Visa Holdings Inc.). EPCOS™ of Epcos AG. FLEXGO™ of Microsoft Corporation. FlexRay™ is licensed by FlexRay Consortium. HYPERTERMINAL™ of Hilgraeve Incorporated. IEC™ of Commission Electrotechnique Internationale. IrDA™ of Infrared Data Association Corporation. ISO™ of INTERNATIONAL ORGANIZATION FOR STANDARDIZATION. MATLAB™ of MathWorks, Inc. MAXIM™ of Maxim Integrated Products, Inc. MICROTec™, NUCLEUS™ of Mentor Graphics Corporation. MIPI™ of MIPI Alliance, Inc. MIPS™ of MIPS Technologies, Inc., USA. muRata™ of MURATA MANUFACTURING CO., MICROWAVE OFFICE™ (MWO) of Applied Wave Research Inc., OmniVision™ of OmniVision Technologies, Inc. Openwave™ Openwave Systems Inc. RED HAT™ Red Hat, Inc. RFMD™ RF Micro Devices, Inc. SIRIUS™ of Sirius Satellite Radio Inc. SOLARIS™ of Sun Microsystems, Inc. SPANSION™ of Spansion LLC Ltd. Symbian™ of Symbian Software Limited. TAIYO YUDEN™ of Taiyo Yuden Co. TEAKLITE™ of CEVA, Inc. TEKTRONIX™ of Tektronix Inc. TOKO™ of TOKO KABUSHIKI KAISHA TA. UNIX™ of X/Open Company Limited. VERILOG™, PALLADIUM™ of Cadence Design Systems, Inc. VLYNQ™ of Texas Instruments Incorporated. VXWORKS™, WIND RIVER™ of WIND RIVER SYSTEMS, INC. ZETEX™ of Diodes Zetex Limited.

Last Trademarks Update 2011-11-11

www.infineon.com

Edition 2015-01-23

Published by

Infineon Technologies AG

81726 Munich, Germany

© 2015 Infineon Technologies AG.

All Rights Reserved.

Do you have a question about any aspect of this document?

Email: erratum@infineon.com

Document reference

ANREF_201504_PL21_017

Legal Disclaimer

THE INFORMATION GIVEN IN THIS APPLICATION NOTE (INCLUDING BUT NOT LIMITED TO CONTENTS OF REFERENCED WEBSITES) IS GIVEN AS A HINT FOR THE IMPLEMENTATION OF THE INFINEON TECHNOLOGIES COMPONENT ONLY AND SHALL NOT BE REGARDED AS ANY DESCRIPTION OR WARRANTY OF A CERTAIN FUNCTIONALITY, CONDITION OR QUALITY OF THE INFINEON TECHNOLOGIES COMPONENT. THE RECIPIENT OF THIS APPLICATION NOTE MUST VERIFY ANY FUNCTION DESCRIBED HEREIN IN THE REAL APPLICATION. INFINEON TECHNOLOGIES HEREBY DISCLAIMS ANY AND ALL WARRANTIES AND LIABILITIES OF ANY KIND (INCLUDING WITHOUT LIMITATION WARRANTIES OF NON-INFRINGEMENT OF INTELLECTUAL PROPERTY RIGHTS OF ANY THIRD PARTY) WITH RESPECT TO ANY AND ALL INFORMATION GIVEN IN THIS APPLICATION NOTE.

Information

For further information on technology, delivery terms and conditions and prices, please contact the nearest Infineon Technologies Office (www.infineon.com).

Warnings

Due to technical requirements, components may contain dangerous substances. For information on the types in question, please contact the nearest Infineon Technologies Office. Infineon Technologies components may be used in life-support devices or systems only with the express written approval of Infineon Technologies, if a failure of such components can reasonably be expected to cause the failure of that life-support device or system or to affect the safety or effectiveness of that device or system. Life support devices or systems are intended to be implanted in the human body or to support and/or maintain and sustain and/or protect human life. If they fail, it is reasonable to assume that the health of the user or other persons may be endangered.