



FPF2148

Full Function Load Switch

Features

- 1.8 to 5.5V Input Voltage Range
- Controlled Turn-On
- 200mA Current Limit Options
- Undervoltage Lockout
- Thermal Shutdown
- <math><2\mu\text{A}</math> Shutdown Current
- Fast Current limit Response Time
 - 5 μs to Moderate Over Currents
 - 30ns to Hard Shorts
- Fault Blanking
- Power Good Function
- RoHS Compliant

Applications

- PDAs
- Cell Phones
- GPS Devices
- MP3 Players
- Digital Cameras
- Peripheral Ports
- Hot Swap Supplies



General Description

The FPF2148 is a load switch which provides full protection to systems and loads which may encounter large current conditions. These devices contain a 0.12 Ω current-limited P-channel MOSFET which can operate over an input voltage range of 1.8-5.5V. Switch control is by a logic input (ONB) capable of interfacing directly with low voltage control signals. The part contains thermal shutdown protection which shuts off the switch to prevent damage to the part when a continuous over-current condition causes excessive heating.

When the switch current reaches the current limit, the part operates in a constant-current mode to prohibit excessive currents from causing damage. For the FPF2148, a current limit condition will immediately pull the fault signal pin low and the part will remain in the constant-current mode until the switch current falls below the current limit. The minimum current limit is 200mA.

The part is available in a space-saving 6 pin 2X2 MLP package.

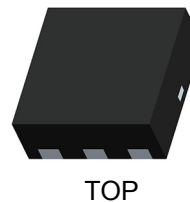
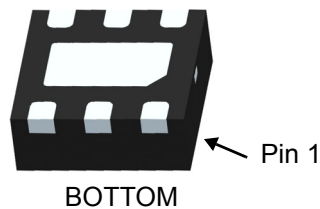

Ordering Information

Part	Current Limit [mA]	Current Limit Blanking Time [ms]	Auto-Restart Time [ms]	ONB Pin Activity
FPF2148	200/300/400	0	NA	Active LO

Typical Application Circuit

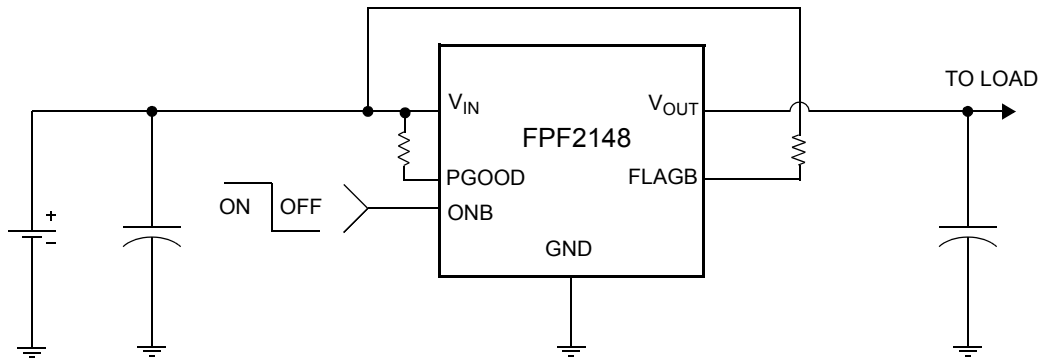

Functional Block Diagram

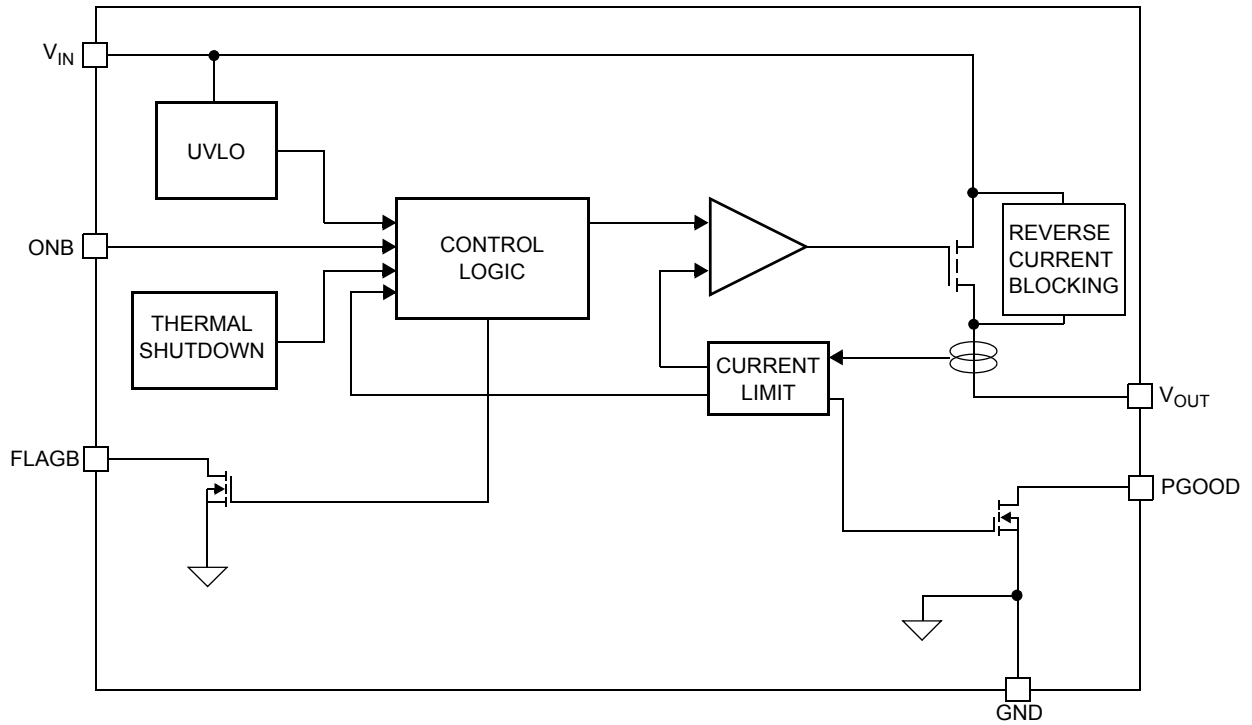

Pin Configuration

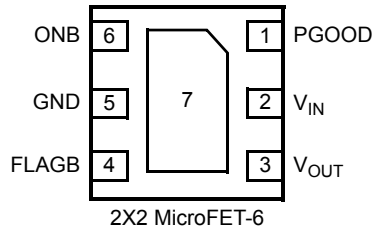

Pin Description

Pin	Name	Function
1	PGOOD	Power Good output: Open drain output which indicate that output voltage has reached 90% of input voltage
2	V_{IN}	Supply Input: Input to the power switch and the supply voltage For the IC
3	V_{OUT}	Switch Output: Output of the power switch
4	FLAGB	Fault Output: Active LO, open drain output which indicates an over current supply under voltage or over temperature state.
5, 7	GND	Ground
6	ONB	ON Control Input

Absolute Maximum Ratings

Parameter	Min	Max	Unit	
V_{IN} , V_{OUT} , ONB, FLAGB, PGOOD to GND	-0.3	6	V	
Power Dissipation		1.2	W	
Operating and Storage Junction Temperature	-65	150	°C	
Thermal Resistance, Junction to Ambient		86	°C/W	
Electrostatic Discharge Protection	Jedec A114A	HBM	4000	V
	Jedec C101C	CDM	2000	V
	Jedec A115	MM	400	V
	IEC 61000-4-2	Air Discharge	15000	V
		Contact Discharge	8000	V

Recommended Operating Range

Parameter	Min	Max	Unit
V_{IN}	1.8	5.5	V
Ambient Operating Temperature, T_A	-40	85	°C

Electrical Characteristics

V_{IN} = 1.8 to 5.5V, T_A = -40 to +85°C unless otherwise noted. Typical values are at V_{IN} = 3.3V and T_A = 25°C.

Parameter	Symbol	Conditions	Min	Typ	Max	Units	
Basic Operation							
Operating Voltage	V_{IN}		1.8		5.5	V	
Quiescent Current	I_Q	$I_{OUT} = 0mA$	$V_{IN} = 1.8V$	40	70	100	μA
			$V_{IN} = 3.3V$		75		
			$V_{IN} = 5.5V$		85	120	

Electrical Characteristics Cont.
 $V_{IN} = 1.8$ to $5.5V$, $T_A = -40$ to $+85^\circ C$ unless otherwise noted. Typical values are at $V_{IN} = 3.3V$ and $T_A = 25^\circ C$.

Parameter	Symbol	Conditions	Min	Typ	Max	Units
On-Resistance	R_{ON}	$V_{IN} = 3.3V, I_{OUT} = 200mA, T_A = 25^\circ C$		120	160	m Ω
		$V_{IN} = 3.3V, I_{OUT} = 200mA, T_A = 85^\circ C$		135	180	
		$V_{IN} = 3.3V, I_{OUT} = 200mA, T_A = -40^\circ C$ to $+85^\circ C$	65		180	
ONB Input Logic High Voltage (ON)	V_{IH}	$V_{IN} = 1.8V$	0.8			V
		$V_{IN} = 5.5V$	1.4			
ONB Input Logic Low Voltage	V_{IL}	$V_{IN} = 1.8V$			0.5	V
		$V_{IN} = 5.5V$			1	
ONB Input Leakage		$V_{ONB} = V_{IN}$ or GND	-1		1	μA
V_{IN} Shutdown Current		$V_{ONB} = 5.5V, V_{OUT} = 5.5V,$ $V_{IN} =$ short to GND	-2		2	μA
FLAGB Output Logic Low Voltage		$V_{IN} = 5V, I_{SINK} = 10mA$		0.05	0.2	V
		$V_{IN} = 1.8V, I_{SINK} = 10mA$		0.12	0.3	
FLAGB Output High Leakage Current		$V_{IN} = 5V, V_{ONB} = 0V$			1	μA
PGOOD Threshold Voltage		$V_{IN} = 5.5V$		90		%
PGOOD Threshold Voltage Hysteresis				1		%
PGOOD Output Logic Low Voltage		$V_{IN} = 5V, I_{SINK} = 10mA$		0.05	0.1	V
		$V_{IN} = 1.8V, I_{SINK} = 10mA$		0.12	0.2	V
PGOOD Output High Leakage Current		$V_{IN} = 5V, V_{ONB} = 0V$			1	μA
Reverse Block						
V_{OUT} Shutdown Current		$V_{ONB} = 5.5V, V_{OUT} = 5.5V,$ $V_{IN} =$ short to GND	-2		2	μA
Protections						
Current Limit	I_{LIM}	$V_{IN} = 3.3V, V_{OUT} = 3.0V$	200	300	400	mA
Thermal Shutdown		Shutdown Threshold T_J increasing		140		$^\circ C$
		Return from Shutdown		130		
		Hysteresis		10		
Under Voltage Lockout	V_{UVLO}	V_{IN} Increasing	1.55	1.65	1.75	V
Under Voltage Lockout Hysteresis				50		mV
Dynamic						
Delay On Time	t_{dON}	$R_L = 500\Omega, C_L = 0.1\mu F$		25		μs
Delay Off Time	t_{dOFF}	$R_L = 500\Omega, C_L = 0.1\mu F$		45		μs
V_{OUT} Rise Time	t_R	$R_L = 500\Omega, C_L = 0.1\mu F$		10		μs
V_{OUT} Fall Time	t_F	$R_L = 500\Omega, C_L = 0.1\mu F$		110		μs
Short Circuit Response Time		$V_{IN} = 5.5V, V_{ONB} = GND.$ Moderate Over-Current Condition		5		μs
		$V_{IN} = 5.5V, V_{ONB} = GND.$ Hard Short		30		ns

Note 1: Package power dissipation on 1square inch pad, 2 oz. copper board.

Typical Characteristics

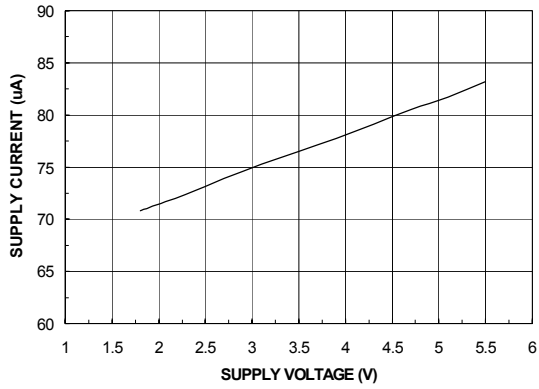

Figure 1. Quiescent Current vs. Input Voltage

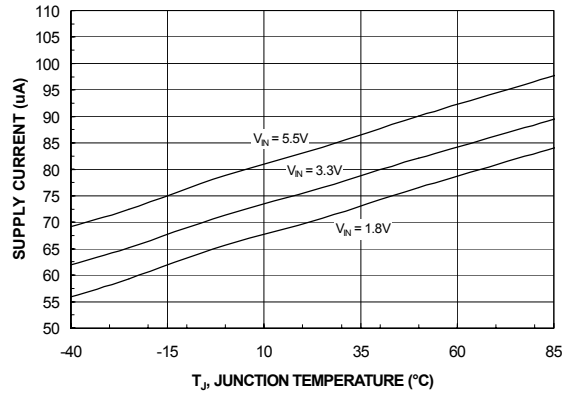

Figure 2. Quiescent Current vs. Temperature

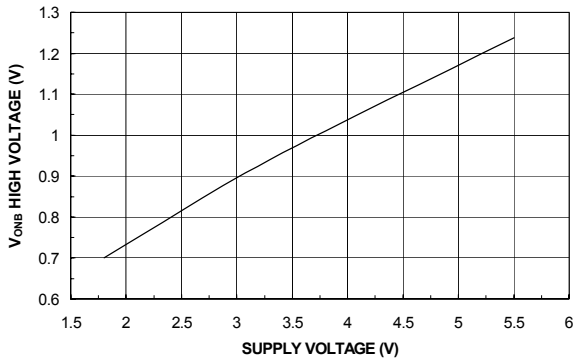

Figure 3. V_{ONB} High Voltage vs. Input Voltage

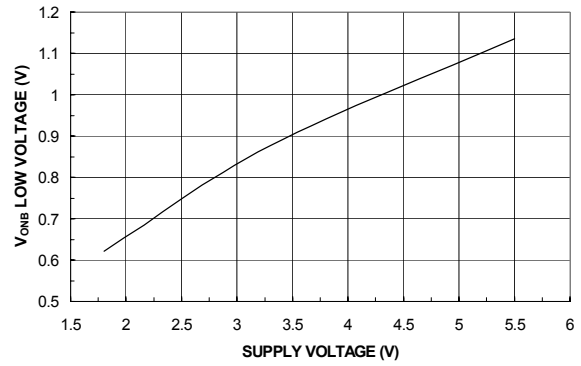

Figure 4. V_{ONB} Low Voltage vs. Input Voltage

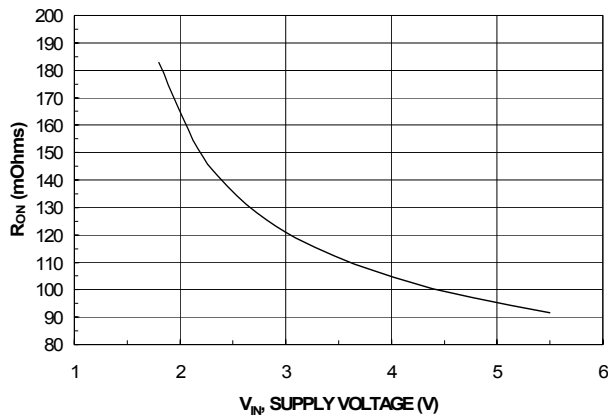

Figure 5. R_{ON} vs. V_{IN}

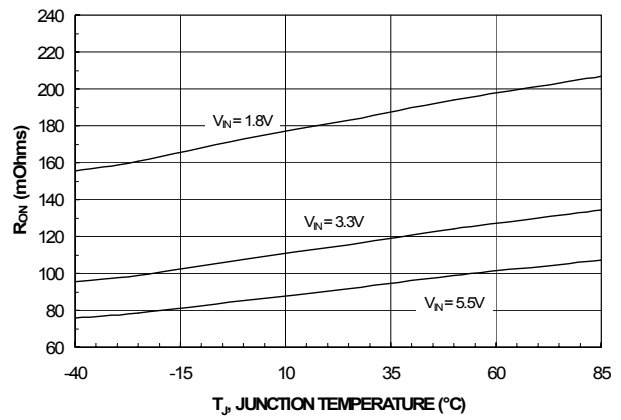

Figure 6. R_{ON} vs. Temperature

Typical Characteristics

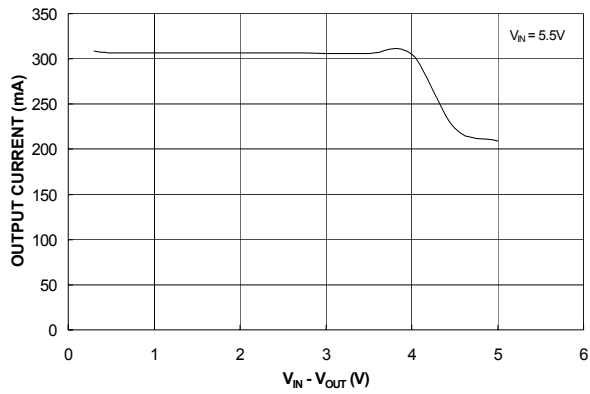

Figure 7. Current Limit vs. Output Voltage

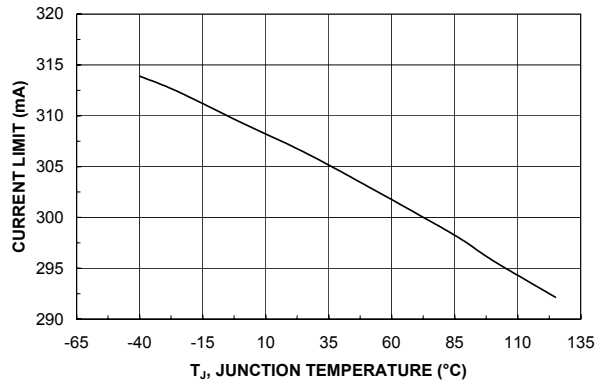

Figure 8. Current Limit vs. Temperature

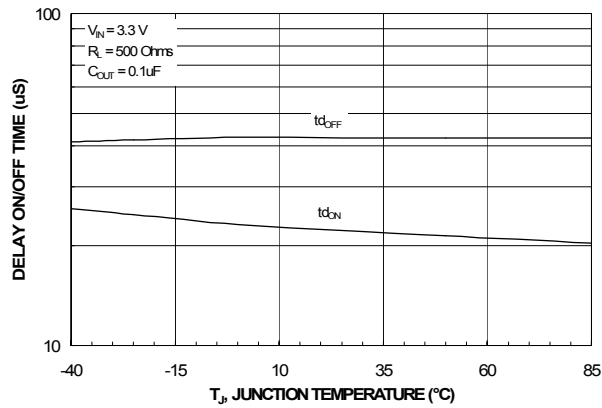

Figure 9. t_{dON} / t_{dOFF} vs. Temperature

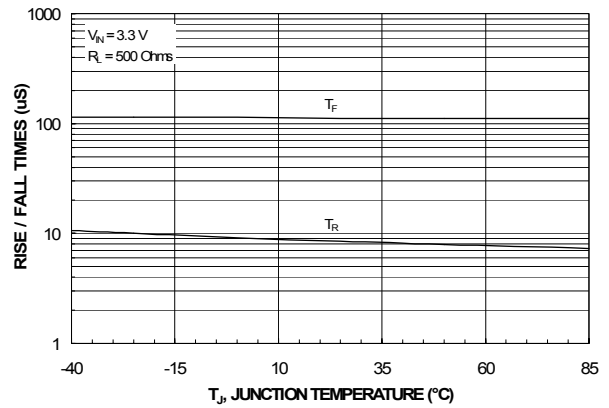

Figure 10. T_{RISE} / T_{FALL} vs. Temperature

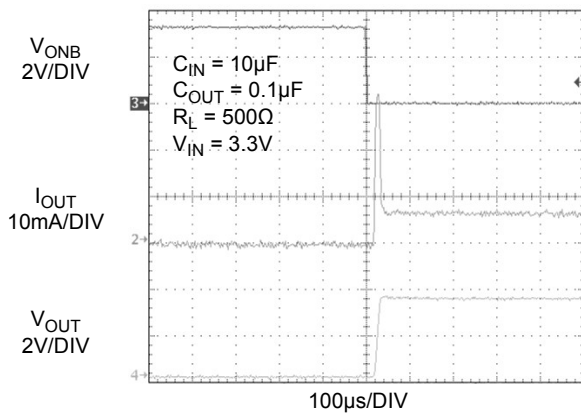

Figure 11. t_{dON} Response

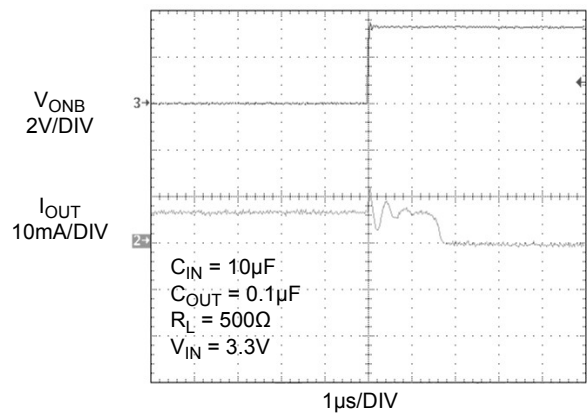

Figure 12. t_{dOFF} Response

Typical Characteristics

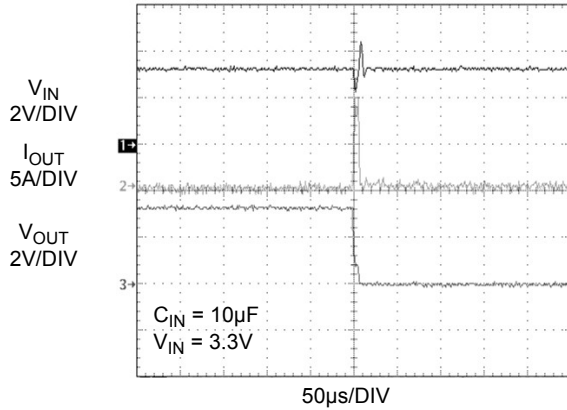

Figure 13. Short Circuit Response Time (Output shorted to GND)

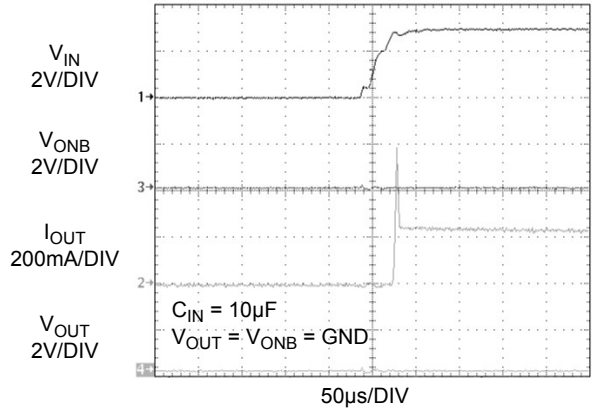

Figure 14. Current Limit Response Time (Switch is powered into a short)

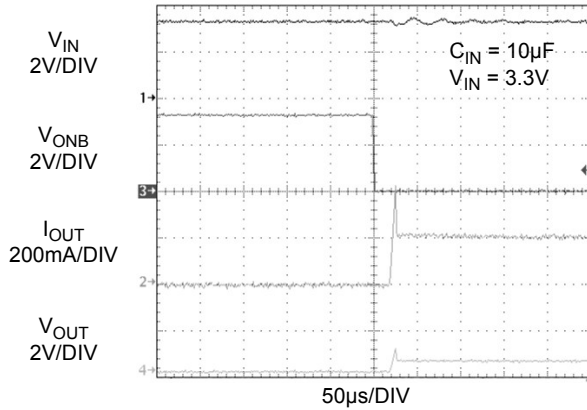

Figure 15. Current Limit Response Time (Output is loaded by 2.2Ω, C_{OUT} = 0.1µF)

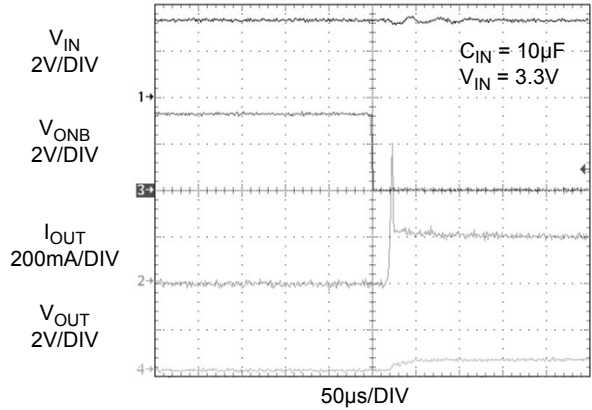

Figure 16. Current Limit Response Time (Output is loaded by 2.2Ω, C_{OUT} = 10µF)

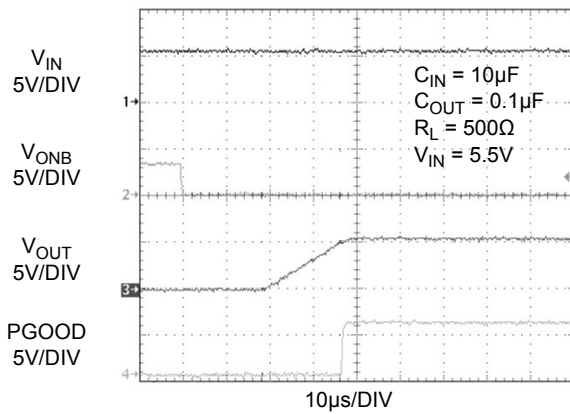

Figure 17. PGOOD Response

Description of Operation

The FPF2148 is a current limited switch that protects systems and loads which can be damaged or disrupted by the application of high currents. The core of each device is a 0.12Ω P-channel MOSFET and a controller capable of functioning over a wide input operating range of 1.8-5.5V. The controller protects against system malfunctions through current limiting, undervoltage lockout and thermal shutdown and power good features. The current limit is preset for 200mA.

On/Off Control

The ONB pin controls the state of the switch. Activating ONB continuously (ONB pin low) holds the switch in the on state so long as there is no undervoltage on V_{IN} or a junction temperature in excess of 140°C. ONB is active LO and has a low threshold making it capable of interfacing with low voltage signals. In addition, excessive currents will cause the switch to turn off due to thermal shutdown. The FPF2148 does not turn off in response to a over current condition but instead remain operating in a constant current mode so long as ONB is active and the thermal shutdown or undervoltage lockout have not activated.

The ON pin control voltage and V_{IN} pin have independent recommended operating ranges. The ON pin voltage can be driven by a voltage level higher than the input voltage.

Fault Reporting

Upon the detection of an over-current, an input undervoltage, or an over-temperature condition, the FLAGB signals the fault mode by activating LO. And the FLAGB goes LO immediately. It will remain LO during the faults and immediately returns HI at the end of the fault condition. FLAGB is an open-drain output which requires a pull-up resistor between V_{IN} and FLAGB. During shutdown, the pull-down on FLAGB is disabled to reduce current draw from the supply.

Current Limiting

The current limit ensures that the current through the switch doesn't exceed 400mA while not limiting at less than 200mA. The FPF2148 have no current limit blanking period so immediately upon a current limit condition FLAGB is activated. The part will remain in a constant current state until the ONB pin is deactivated or the thermal shutdown turns-off the switch.

Undervoltage Lockout

The undervoltage lockout turns-off the switch if the input voltage drops below the undervoltage lockout threshold. With the ONB pin active the input voltage rising above the undervoltage lockout threshold will cause a controlled turn-on of the switch which limits current over-shoots.

Thermal Shutdown

The thermal shutdown protects the die from internally or externally generated excessive temperatures. During an over-temperature condition the FLAGB is activated and the switch is turned-off. The switch automatically turns-on again if temperature of the die drops below the threshold temperature.

Power Good

FPF2148 has a "Power Good" feature. PGOOD pin is an open-drain MOSFET which asserts high when the output voltage reaches 90% of the input voltage.

PGOOD pin requires an external pull up resistor that is connected to the output voltage when there is no battery in the load side and the logic level of the subsequent controller permits. This would give logic levels similar to a CMOS output stage for PGOOD, while still keeping the option to tie the pull-up to a different supply voltage. A 100KΩ is recommended to be used as pull up resistor. The PGOOD pin status is independent of the ONB pin position. This mean that PGOOD pin stays low when the load switch is OFF. If the Power Good feature is not used in the application the pin can be connected directly to GND.

Timing Diagram

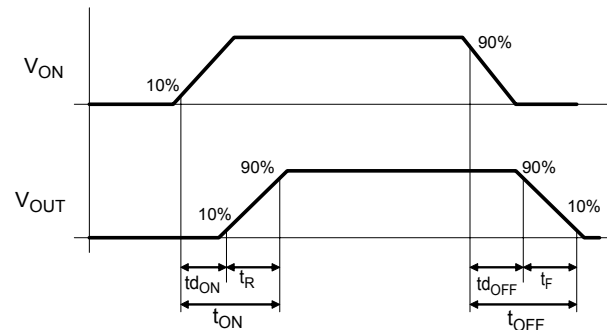

where:

- t_{dON} = Delay On Time
- t_r = V_{OUT} Rise Time
- t_{ON} = Turn On Time
- t_{dOFF} = Delay Off Time
- t_f = V_{OUT} Fall Time
- t_{OFF} = Turn Off Time

Application Information

Typical Application

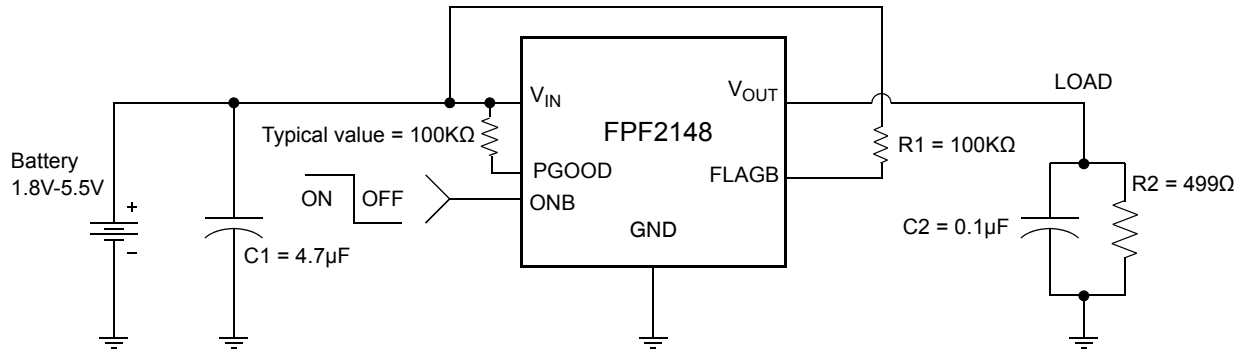

Input Capacitor

To limit the voltage drop on the input supply caused by transient in-rush currents when the switch turns-on into a discharged load capacitor or a short-circuit, a capacitor needs to be placed between V_{IN} and GND. A $4.7\mu\text{F}$ ceramic capacitor, C_{IN} , must be placed close to the V_{IN} pin. A higher value of C_{IN} can be used to further reduce the voltage drop experienced as the switch is turned on into a large capacitive load.

Output Capacitor

A $0.1\mu\text{F}$ capacitor C_{OUT} , should be placed between V_{OUT} and GND. This capacitor will prevent parasitic board inductances from forcing V_{OUT} below GND when the switch turns-off. For the FPF2148, the total output capacitance needs to be kept below a maximum value, $C_{OUT(max)}$, to prevent the part from registering an over-current condition and turning-off the switch. The maximum output capacitance can be determined from the following formula,

$$C_{OUT(max)} = \frac{I_{LIM(max)} \times t_R(max)}{V_{IN}} \quad (1)$$

Power Dissipation

During normal operation as a switch, the power dissipation is small and has little effect on the operating temperature of the part. The parts with the higher current limits will dissipate the most power and that will only be,

$$P = (I_{LIM})^2 \times R_{DS} = (0.4)^2 \times 0.12 = 19.2\text{mW} \quad (2)$$

If the part goes into current limit the maximum power dissipation will occur when the output is shorted to ground. For the FPF2148, a short on the output will cause the part to operate in a constant current state dissipating a worst case power as calculated in (3) until the thermal shutdown activates. It will then cycle in and out of thermal shutdown so long as the ONB pin is active and the short is present.

$$\begin{aligned} P(max) &= V_{IN(max)} \times I_{LIM(max)} \\ &= 5.5 \times 0.4 = 275\text{mW} \end{aligned} \quad (3)$$

Board Layout

For best performance, all traces should be as short as possible. To be most effective, the input and output capacitors should be placed close to the device to minimize the effects that parasitic trace inductances may have on normal and short-circuit operation. Using wide traces for V_{IN} , V_{OUT} and GND will help minimize parasitic electrical effects along with minimizing the case to ambient thermal impedance.

The middle pad (pin 7) should be connected to the GND plate of PCB for improving thermal performance of the load switch. An improper layout could result higher junction temperature and triggering the thermal shutdown protection feature. This concern applies when the switch is in an overcurrent condition or the worst case when output is shorted to ground.

Application Notes

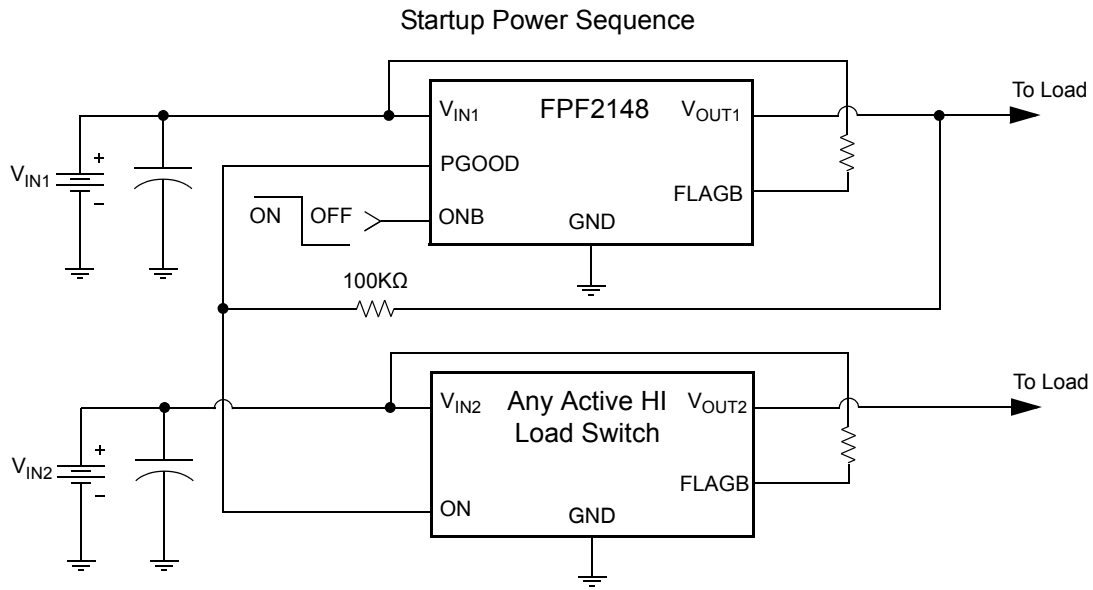

Power good function in sequential startup. No battery is loaded to the output

Sequential Startup using Power Good

The power good pin can be connected to another active high load switch's enable pin to implement sequential startup. PGOOD pin asserts low when the load switch is OFF. This feature allows driving a subsequent circuit. The diagram above illustrates power good function in sequential startup. As the V_{OUT1} of the FPF2148 starts to ramp to the 90% of its input voltage the active high switch remains in OFF state. Whereas the V_{OUT1} passes the 90% threshold, power good signal becomes active and asserts high. This signal will turn on the active high load switch and V_{OUT2} will start to increase. The total startup time may vary according to the difference between supply voltages that are used in the application.

Dimensional Outline and Pad Layout

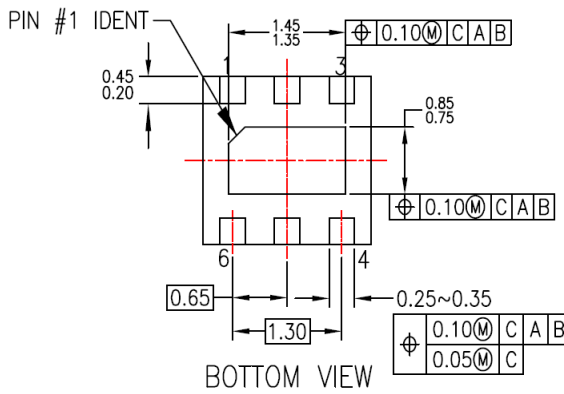
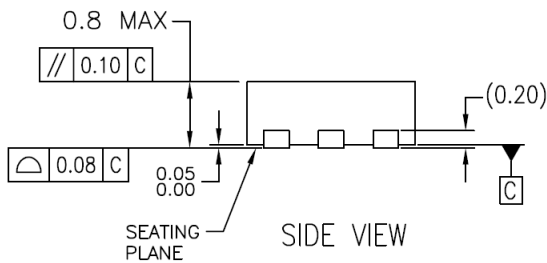
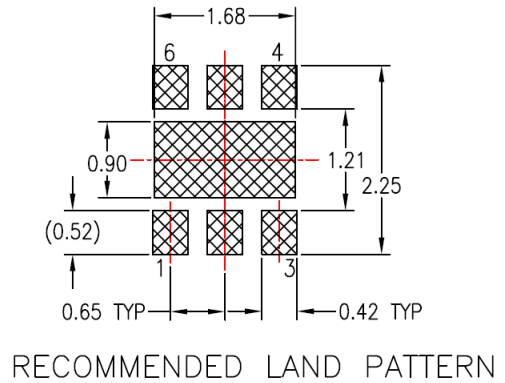
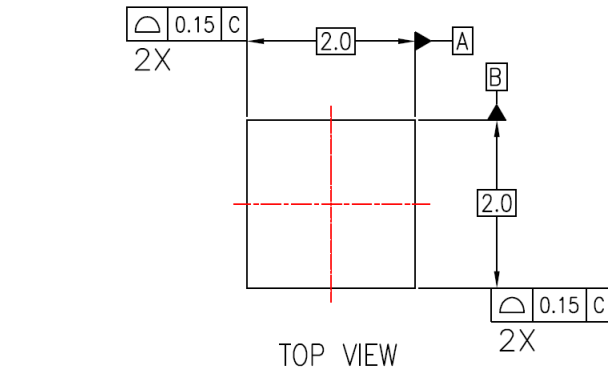

NOTES:





- A. NON-CONFORMS TO JEDEC REGISTRATION,
- B. DIMENSIONS ARE IN MILLIMETERS.
- C. DIMENSIONS AND TOLERANCES PER ASME Y14.5M, 1994

MLP06KrevA



TRADEMARKS

The following includes registered and unregistered trademarks and service marks, owned by Fairchild Semiconductor and/or its global subsidiaries, and is not intended to be an exhaustive list of all such trademarks.

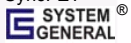
- | | | | |
|--|---|--|---|
| Build it Now™ | FRFET® | Programmable Active Droop™ | the power franchise |
| CorePLUS™ | Global Power ResourceSM | QFET® | TinyBoost™ |
| CorePOWER™ | Green FPS™ | QS™ | TinyBuck™ |
| CROSSVOLT™ | Green FPS™ e-Series™ | Quiet Series™ | TinyLogic® |
| CTL™ | GTO™ | RapidConfigure™ | TINYOPTO™ |
| Current Transfer Logic™ | IntelliMAX™ |  TM | TinyPower™ |
| EcoSPARK® | ISOPLANAR™ | Saving our world, 1mW/W/kW at a time™ | TinyPWM™ |
| EfficientMax™ | MegaBuck™ | SmartMax™ | TinyWire™ |
| EZSWITCH™ * | MICROCOUPLER™ | SMART START™ | µSerDes™ |
|  TM | MicroFET™ | SPM® |  SerDes™ |
|  ® | MillerDrive™ | STEALTH™ | UHC® |
| Fairchild® | MotionMax™ | SuperFET™ | Ultra FRFET™ |
| Fairchild Semiconductor® | Motion-SPM™ | SuperSOT™_3 | UniFET™ |
| FACT Quiet Series™ | OPTOLOGIC® | SuperSOT™_6 | VCX™ |
| FACT® | OPTOPLANAR® | SuperSOT™_8 | VisualMax™ |
| FAST® |  ® | SupreMOS™ | XS™ |
| FastvCore™ | PDP SPM™ | SyncFET™ | |
| FlashWriter® * | Power-SPM™ |  SYSTEM GENERAL | |
| FPS™ | PowerTrench® | The Power Franchise® | |
| F-PFS™ | PowerXS™ | | |

* EZSWITCH™ and FlashWriter® are trademarks of System General Corporation, used under license by Fairchild Semiconductor.

DISCLAIMER

FAIRCHILD SEMICONDUCTOR RESERVES THE RIGHT TO MAKE CHANGES WITHOUT FURTHER NOTICE TO ANY PRODUCTS HEREIN TO IMPROVE RELIABILITY, FUNCTION, OR DESIGN. FAIRCHILD DOES NOT ASSUME ANY LIABILITY ARISING OUT OF THE APPLICATION OR USE OF ANY PRODUCT OR CIRCUIT DESCRIBED HEREIN; NEITHER DOES IT CONVEY ANY LICENSE UNDER ITS PATENT RIGHTS, NOR THE RIGHTS OF OTHERS. THESE SPECIFICATIONS DO NOT EXPAND THE TERMS OF FAIRCHILD'S WORLDWIDE TERMS AND CONDITIONS, SPECIFICALLY THE WARRANTY THEREIN, WHICH COVERS THESE PRODUCTS.

LIFE SUPPORT POLICY

FAIRCHILD'S PRODUCTS ARE NOT AUTHORIZED FOR USE AS CRITICAL COMPONENTS IN LIFE SUPPORT DEVICES OR SYSTEMS WITHOUT THE EXPRESS WRITTEN APPROVAL OF FAIRCHILD SEMICONDUCTOR CORPORATION.

As used herein:

1. Life support devices or systems are devices or systems which, (a) are intended for surgical implant into the body or (b) support or sustain life, and (c) whose failure to perform when properly used in accordance with instructions for use provided in the labeling, can be reasonably expected to result in a significant injury of the user.
2. A critical component in any component of a life support, device, or system whose failure to perform can be reasonably expected to cause the failure of the life support device or system, or to affect its safety or effectiveness.

ANTI-COUNTERFEITING POLICY

Fairchild Semiconductor Corporation's Anti-Counterfeiting Policy. Fairchild's Anti-Counterfeiting Policy is also stated on our external website, www.fairchildsemi.com, under Sales Support.

Counterfeiting of semiconductor parts is a growing problem in the industry. All manufactures of semiconductor products are experiencing counterfeiting of their parts. Customers who inadvertently purchase counterfeit parts experience many problems such as loss of brand reputation, substandard performance, failed application, and increased cost of production and manufacturing delays. Fairchild is taking strong measures to protect ourselves and our customers from the proliferation of counterfeit parts. Fairchild strongly encourages customers to purchase Fairchild parts either directly from Fairchild or from Authorized Fairchild Distributors who are listed by country on our web page cited above. Products customers buy either from fairchild directly or from Authorized Fairchild Distributors are genuine parts, have full traceability, meet Fairchild's quality standards for handling and storage and provide access to Fairchild's full range of up-to-date technical and product information. Fairchild and our Authorized Distributors will stand behind all warranties and will appropriately address and warranty issues that may arise. Fairchild will not provide any warranty coverage or other assistance for parts bought from Unauthorized Sources. Fairchild is committed to combat this global problem and encourage our customers to do their part in stopping this practice by buying direct or from authorized distributors.

PRODUCT STATUS DEFINITIONS

Definition of Terms

Datasheet Identification	Product Status	Definition
Advance Information	Formative / In Design	Datasheet contains the design specifications for product development. Specifications may change in any manner without notice.
Preliminary	First Production	Datasheet contains preliminary data; supplementary data will be published at a later date. Fairchild Semiconductor reserves the right to make changes at any time without notice to improve design.
No Identification Needed	Full Production	Datasheet contains final specifications. Fairchild Semiconductor reserves the right to make changes at any time without notice to improve the design.
Obsolete	Not In Production	Datasheet contains specifications on a product that is discontinued by Fairchild Semiconductor. The datasheet is for reference information only.

Rev. I37