

CLC404

Wideband, High Slew Rate, Monolithic Op Amp

General Description

The CLC404 is a high speed, monolithic op amp that combines low power consumption (110mW typical, 120mW maximum) with superior large signal performance. Operating off of $\pm 5V$ supplies, the CLC404 demonstrates a large signal bandwidth (5V_{PP} output) of 165MHz. The bandwidth performance, along with other speed characteristics such as rise and fall time (2.1ns for a 5V step), is nearly identical to the small signal performance since slew rate is not limiting factor in the CLC404 design.

With its 175MHz bandwidth and 10ns settling (0.2%), the CLC404 is ideal for driving ultra fast flash A/D converters. The 0.5° deviation from linear phase, coupled with -53dBc 2nd harmonic distortion and -60dBc 3rd harmonic distortion (both at 20MHz), is well suited for many digital and analog communication applications. These same characteristics, along with 70mA output current, differential gain of 0.07%, and differential phase at 0.03°, make the CLC404 an appropriate high performance solution for video distribution and line driving applications.

Constructed using an advanced, complementary bipolar process and proven current feedback topologies, the CLC404 provides performance far beyond that of other monolithic op amps. The CLC404 is available in several versions to meet a variety of requirements.

Enhanced Solutions (Military/Aerospace)

SMD Number: 5962-90994

Space level versions also available.

For more information, visit <http://www.national.com/mil>

Features

- 165MHz large signal bandwidth (5V_{PP})
- 2600V/ μ s slew rate
- Low Power: 110mW
- Low distortion: -53dBc at 20MHz
- 10ns settling to 0.2%
- 0.07% diff. gain, 0.03° diff. phase

Applications

- Fast A/D conversion
- Line drivers
- Video distribution
- High speed communications
- Radar, IF processors

Large Signal Pulse Response

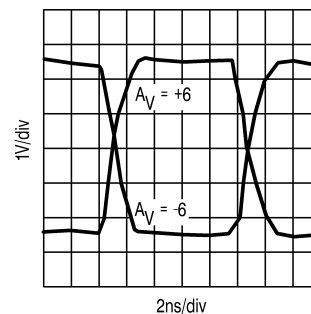

01274607

Connection Diagrams

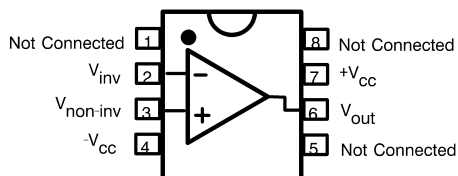

**Pinout
DIP & SOIC**

01274619

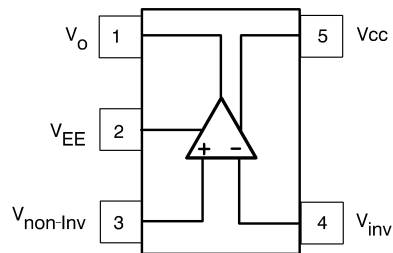

**Pinout
SOT 23-5**

01274618

Absolute Maximum Ratings (Note 1)

If Military/Aerospace specified devices are required, please contact the National Semiconductor Sales Office/Distributors for availability and specifications.

Supply Voltage (V_{CC})	$\pm 7V$
I_{OUT}	
Output is short circuit protected to ground, but maximum reliability will be maintained if I_{OUT} does not exceed...	60mA
Common Mode Input Voltage	$\pm V_{CC}$
Differential Input Voltage	10V
Junction Temperature	+150°C

Operating Temperature Range	-40°C to +85°C
Storage Temperature Range	-65°C to +150°C
Lead Solder Duration (+300°C)	10 sec
ESD rating (human body model)	500V

Operating Ratings

Thermal Resistance		
Package	(θ_{JC})	(θ_{JA})
MDIP	65°C/W	120°C/W
SOIC	60°C/W	140°C/W

Electrical Characteristics

$A_V = +6$, $V_{CC} = \pm 5V$, R_g & $R_L = 100\Omega$, $R_f = 500\Omega$; unless specified

Symbol	Parameter	Conditions	Typ	Max/Min Ratings (Note 2)			Units
Ambient Temperature		CLC404AJ	+25°C	-40°C	+25°C	+85°C	
Frequency Domain Response							
SSBW	-3dB Bandwidth	$V_{OUT} < 2V_{PP}$	175	>150	>140	>120	MHz
LSBW	-3dB Large Signal	$V_{OUT} < 5V_{PP}$	165	>140	>140	>110	MHz
	Gain Flatness	$V_{OUT} < 2V_{PP}$					
GFPL	Peaking	<40MHz	0	<0.4	<0.3	<0.4	dB
GFPH	Peaking	>40MHz	0	<0.7	<0.5	<0.7	dB
GFR	Rolloff	<75MHz	0.2	<1.0	<1.1	<1.3	dB
LPD	Linear Phase Deviation	DC to 75MHz	0.5	<1.0	<1.0	<1.2	deg
Time Domain Response							
TRS	Rise and Fall Time	2V Step	2.0	<2.4	<2.4	<2.9	ns
TRL		5V Step	2.1	<2.6	<2.6	<3.2	ns
TS	Settling Time to $\pm 0.2\%$	2V Step	10	<15	<15	<15	ns
OS	Overshoot	2V Step	5	<15	<12	<15	%
SR	Slew Rate (Measured at $A_V + 2$) (Note 4)		2600	>2000	>2000	>2000	V/ μ s
Distortion And Noise Response							
HD2	2nd Harmonic Distortion	$2V_{PP}, 20MHz$	-53	<-40	<-45	<-45	dBc
HD3	3rd Harmonic Distortion	$2V_{PP}, 20MHz$	-60	<-50	<-50	<-50	dBc
	Equivalent Input Noise						
SNF	Noise Floor	>1MHz	-159	<-157	<-157	<-156	dBm (1Hz)
INV	Integrated Noise	1MHz to 200MHz	40	<45	<45	<50	μ V
DG	Differential Gain (Note 3)		0.07	-	-	-	%
DP	Differential Phase (Note 3)		0.03	-	-	-	°
Static, DC Performance							
VIO	Input Offset Voltage (Note 5)		2	< ± 9.0	< ± 5.0	< ± 10.0	mV
DVIO	Average Temperature Coefficient		30	< ± 50	-	< ± 50	μ V/°C
IBN	Input Bias Current (Note 5)	Non Inverting	15	< ± 44	< ± 22	< ± 22	μ A
DIBN	Average Temperature Coefficient		150	< ± 275	-	< ± 200	nA/°C
IBI	Input Bias Current (Note 5)	Inverting	15	< ± 40	< ± 18	< ± 22	μ A
DIBI	Average Temperature Coefficient		150	< ± 275	-	< ± 200	nA/°C
PSRR	Power Supply Rejection Ratio		52	>45	>48	>45	dB
CMRR	Common Mode Rejection Ratio		50	>44	>46	>44	dB

Electrical Characteristics (Continued)
 $A_V = +6$, $V_{CC} = \pm 5V$, R_g & $R_L = 100\Omega$, $R_f = 500\Omega$; unless specified

Symbol	Parameter	Conditions	Typ	Max/Min Ratings (Note 2)			Units
ICC	Supply Current (Note 5)	No Load, Quiescent	11	<12	<12	<12	mA
Miscellaneous Performance							
RIN	Non-Inverting Input	Resistance	1000	>250	>500	>1000	k Ω
CIN		Capacitance	1	<2	<2	<2	pF
RO	Output Impedence	At DC	0.1	<0.3	<0.2	<0.2	Ω
VO	Output Voltage Range	No Load	± 3.3	$> \pm 2.8$	$> \pm 3.0$	$> \pm 3.0$	V
CMIR	Common Mode Input Range	For Rated Performance	± 2.2	$> \pm 1.4$	$> \pm 1.8$	$> \pm 2.0$	V
IO	Output Current		± 60	$> \pm 35$	$> \pm 50$	$> \pm 50$	mA

Note 1: "Absolute Maximum Ratings" are those values beyond which the safety of the device cannot be guaranteed. They are not meant to imply that the devices should be operated at these limits. The table of "Electrical Characteristics" specifies conditions of device operation.

Note 2: Max/min ratings are based on product characterization and simulation. Individual parameters are tested as noted. Outgoing quality levels are determined from tested parameters.

Note 3: Differential gain and phase measured at $A_V + 2$, $R_f 500\Omega$, $R_L 150\Omega$ $1V_{pp}$ equivalent video signal, 0-100 IRE, 40 IRE_{pp}, 0IRE = 0 volts, at 75 Ω load and 3.58MHz. See text.

Note 4: See the text on the back of the datasheet.

Note 5: AJ-level: spec. is 100% tested at +25°C, sample at 85°C.

Ordering Information

Package	Temperature Range Industrial	Part Number	Package Marking	NSC Drawing
8-pin plastic DIP	-40°C to +85°C	CLC404AJP	CLC404AJP	N08E
8-pin plastic SOIC	-40°C to +85°C	CLC404AJE	CLC404AJE	M08A
5-pin SOT	-40°C to +85°C	CLC404AJM5	A16	MA05A

Typical Performance Characteristics

Frequency Response $A_V = +2V/V$

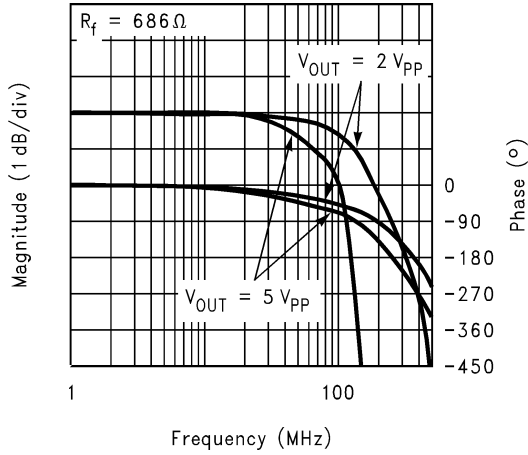

01274601

Frequency Response $A_V = +6V/V$

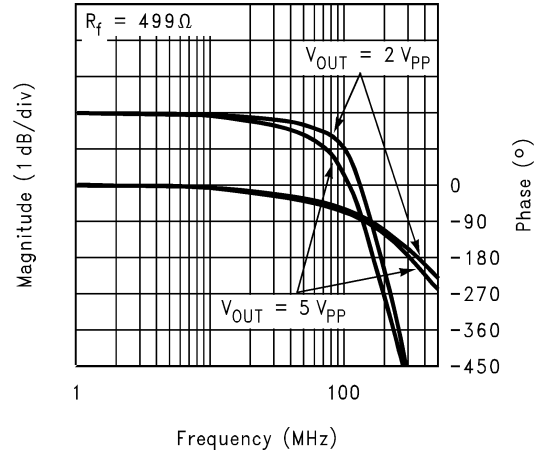

01274602

Frequency Response $A_V = +20V/V$

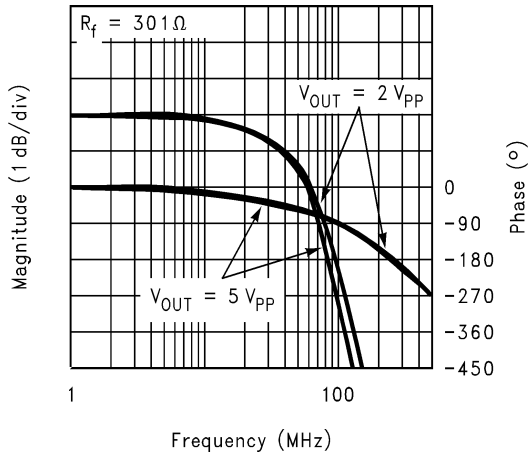

01274603

Inverting Frequency Response

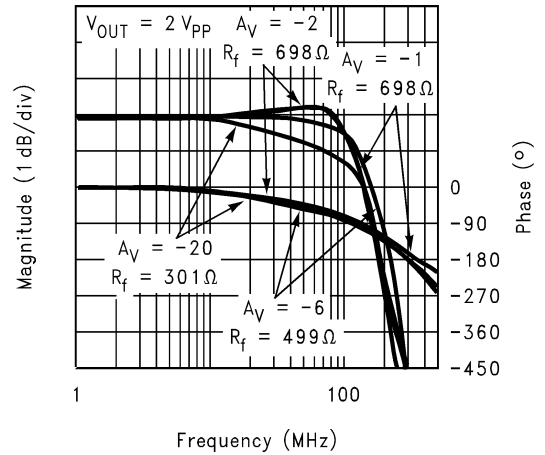

01274604

Bandwidth vs Load Capacitance

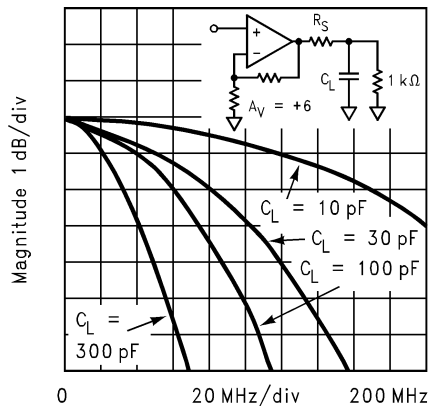

01274605

Recommended R_S vs Load Capacitance

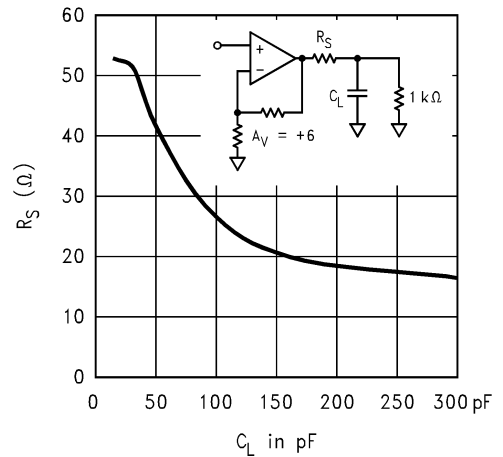

01274606

Typical Performance Characteristics (Continued)

Large Signal Pulse Response

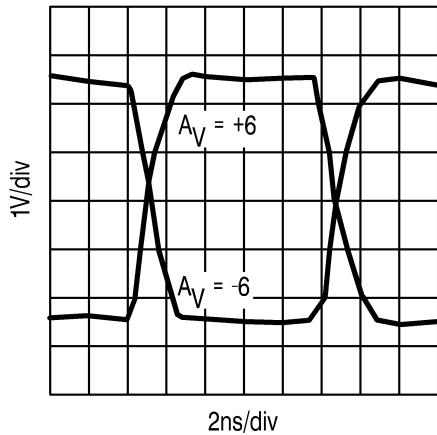

01274607

2nd Harmonic Dist. vs. Amplitude

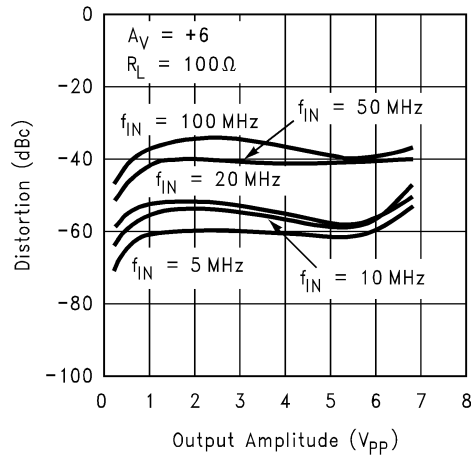

01274608

3rd Harmonic Dist. vs. Amplitude

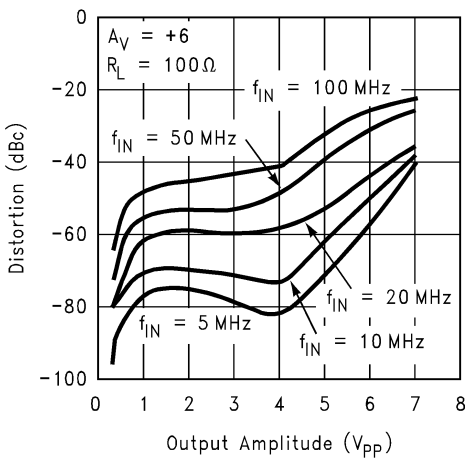

01274609

Settling Time

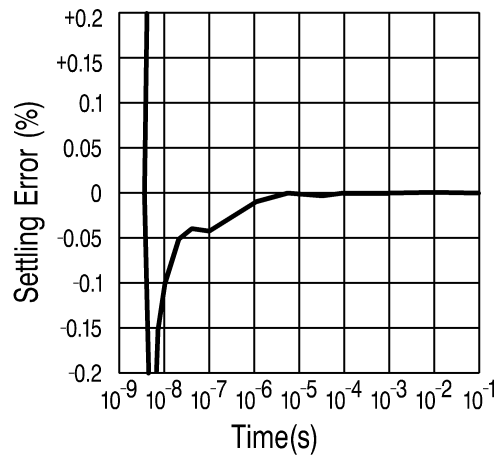

01274610

2nd Harmonic Distortion $C_L = 25$ pF

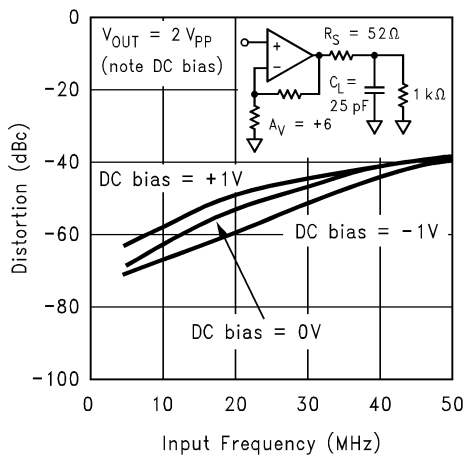

01274611

3rd Harmonic Distortion $C_L = 25$ pF

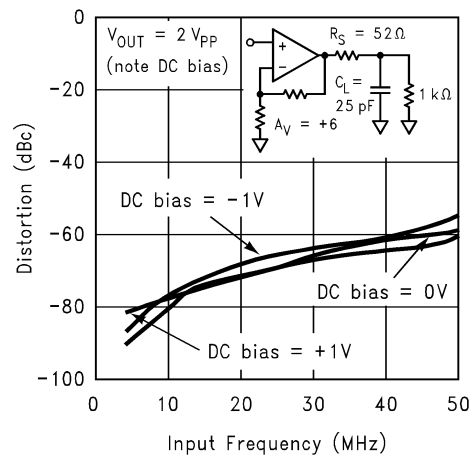

01274612

Typical Performance Characteristics (Continued)

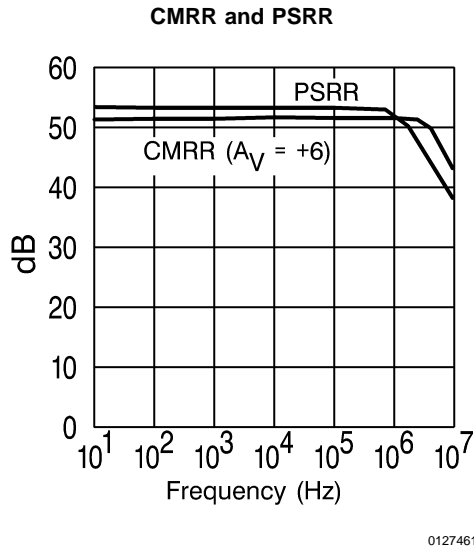
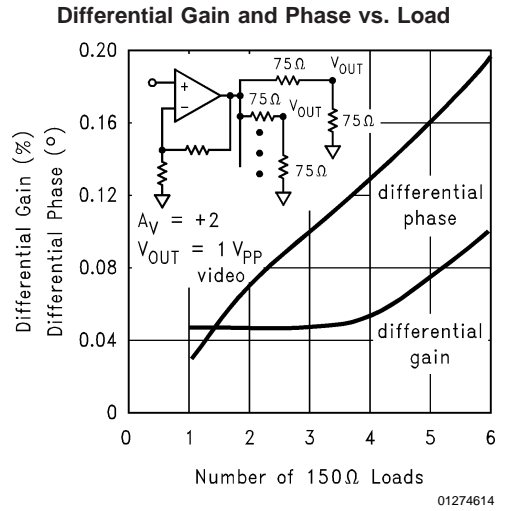
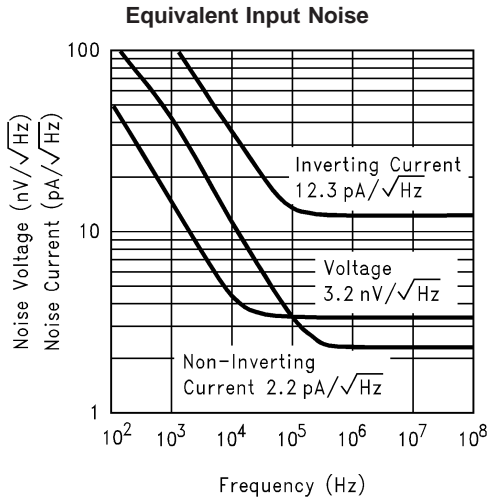

Application Division

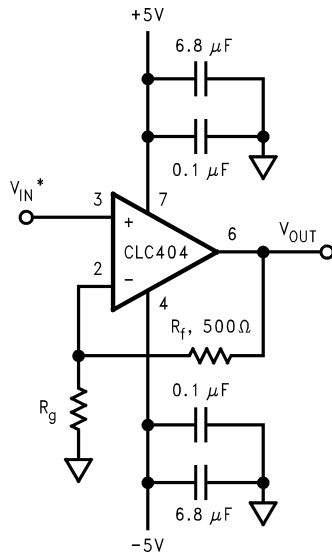

$$A_V = 1 + \frac{R_f}{R_g}$$

*See source impedance discussion.

For optimum performance, R_f and R_g should be low-inductance, low-capacitance resistors.

(Pin designations are for DIP versions.)

01274616

FIGURE 1. Recommended Non-Inverting Gain Circuit

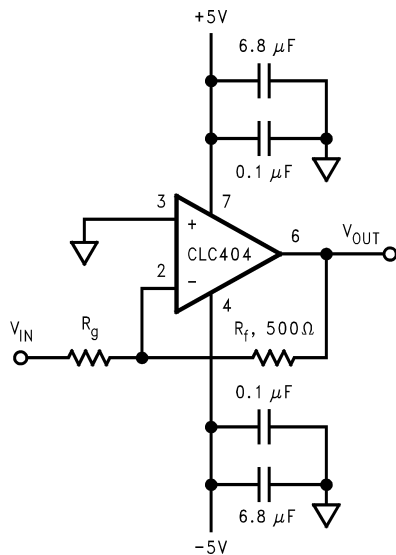

$$A_V = \frac{-R_f}{R_g}$$

For optimum performance, R_f and R_g should be low-inductance, low-capacitance resistors.

(Pin designations are for DIP versions.)

01274617

FIGURE 2. Recommended Inverting Gain Circuit

Slew Rate

Slew rate limiting is a nonlinear response which occurs in amplifiers when the output voltage swing approaches hard, abrupt limits in the speed at which it can change. In most applications, this results in an easily identifiable "slew rate" as well as a dramatic increase in distortion for large signal levels. The CLC404 has been designed to provide enough slew rate to avoid slew rate limiting in almost all circuit configurations. The large signal bandwidth of 165MHz, therefore, is nearly the same as the 175MHz small signal bandwidth. The result is a low-distortion, linear system for both small signals and large signals.

Slew rate and large signal performance in the CLC404 can best be understood by first comparing the small and large signal performance plots at a gain of +6. In the CLC404,

there is almost no difference between large and small signal performance at this gain. Large signal performance in the CLC404 at a gain of +6 is not slew rate limited. (In an amplifier which is slew limiting, the large signal response rolloff has an abrupt break indicating the onset of slew rate limitation.)

The CLC404 reaches slew rate limits only for low non-inverting gains. In other words, slew rate limiting is constrained by common mode voltage swings at the input. (This is different from traditional slew rate constraints.) The large-signal frequency response plot at a gain of +2 shows a break in the response, which shows that slew rate limit has been reached. Note also that the frequency response plots at gain of +21 show that the large signal and small signal responses are nearly identical.

Differential Gain and Phase

Differential gain and phase are measurements useful primarily in composite video channels. Differential gain and phase are measured by monitoring the gain and phase of a high frequency carrier (3.58MHz for NTSC composite video) as the output of the amplifier is swept over a range of DC voltages. Any changes in gain and phase at the carrier frequency are the desired measurement, differential gain and phase.

Specifications for the CLC404 include differential gain and phase. The test signals used are based on a $1V_{PP}$ video level. Test conditions used are the following.

DC sweep range: 0 to 100 IRE units (black to white)

Carrier: 3.58MHz at 40 IRE units peak to peak

The amplifier is specified for a gain of +2, and 150Ω load (for a backmatched 75Ω system.) IRE amplitudes are referred to 75Ω at the load of a video system. This is a different condition from the rest of the specifications ($A_V = +6$, $R_f = 100\Omega$).

Source Impedance

For best results, source impedance in the non-inverting circuit configuration (see *Figure 1*) should be kept below $3k\Omega$. Above $3k\Omega$ it is possible for oscillation to occur, depending on other circuit parasitics. Depending on the signal source, a resistor with a value of less than $3k\Omega$ may be used to terminate the non-inverting input to ground.

Feedback Resistor

In current-feedback op amps, the value of the feedback resistor plays a major role in determining amplifier dynamics. It is important to select the correct value resistor. The CLC404 provides optimum performance with a 500Ω feedback resistor. Furthermore, the specifications shown on the

previous pages are valid only when a 500Ω feedback resistor is used. Selection of an incorrect value can lead to severe rolloff in frequency-response (if the resistor value is too large) or peaking or oscillation (if the value is too low).

Printed Circuit Layout

As with any high frequency device, a good PCB layout will enhance performance. Ground plane construction and good power supply bypassing close to the package are critical to achieving full performance. In the non-inverting configuration, the amplifier is sensitive to stray capacitance to ground at the inverting input. Hence, the inverting node connections should be small with minimal coupling to the ground plane. Shunt capacitance across the feedback resistor should not be used to compensate for this effect.

Parasitic or load capacitance directly on the output will introduce additional phase shift in the loop degrading the loop phase margin and leading to frequency response peaking. A small series resistor before the capacitance effectively decouples this effect. The graphs on the preceding page illustrate the required resistor value and resulting performance vs. capacitance.

Precision buffered resistors (PRP8351 series from Precision Resistive Products) with low parasitic reactances were used to develop the data sheet specifications. Precision carbon composition resistors will also yield excellent results. Standard spirally-trimmed RN55D metal film resistors will work with a slight decrease in bandwidth due to their reactive nature at high frequencies.

Evaluation PC boards (part numbers CLC730013 for through-hole and CLC 730027 for SOIC) for the CLC404 are available.

Physical Dimensions inches (millimeters)

unless otherwise noted

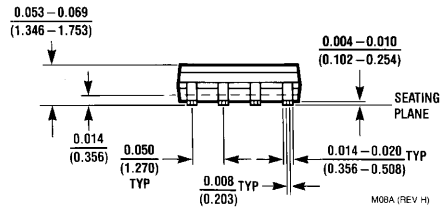
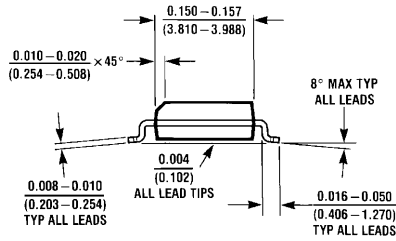
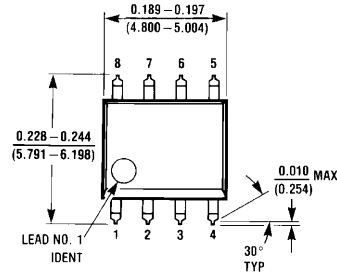

NS Product Number M08A

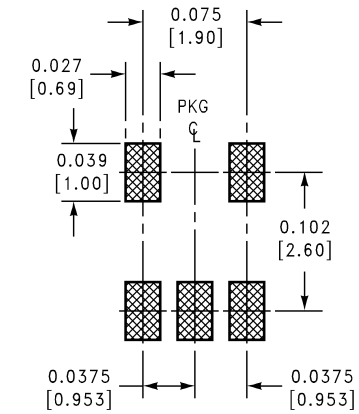
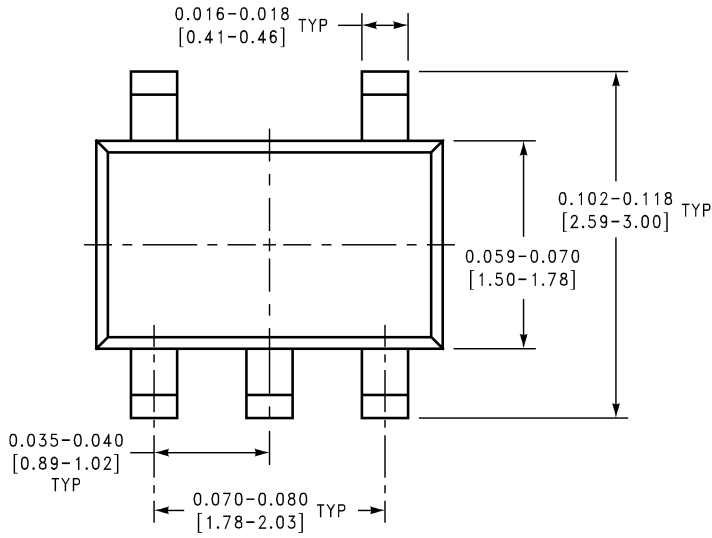

LAND PATTERN RECOMMENDATION

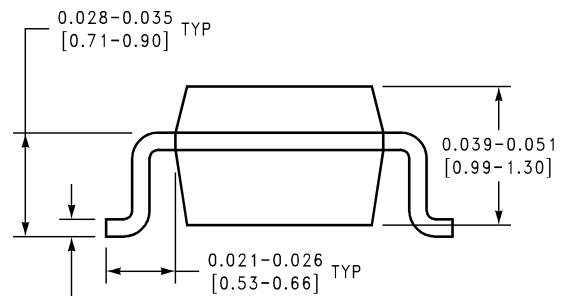
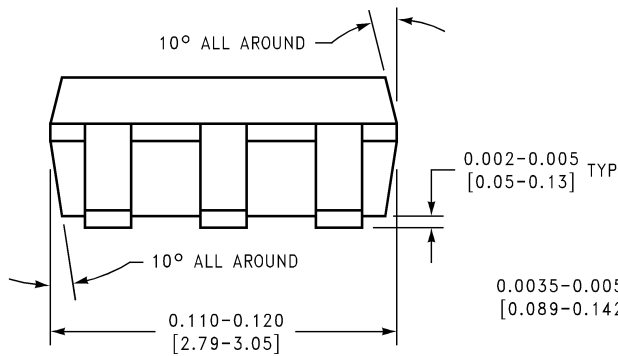

MA05A (REV D)

NS Product Number MA05A

Physical Dimensions inches (millimeters) unless otherwise noted (Continued)

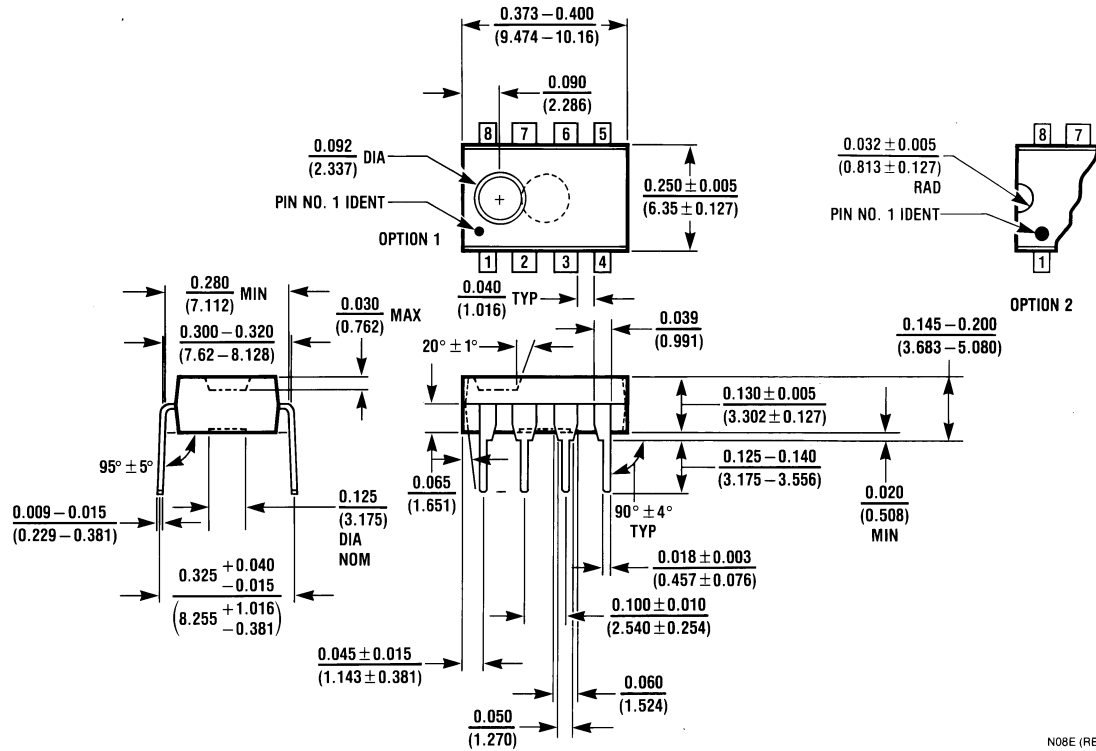

NS Product Number N08E

N08E (REV F)

LIFE SUPPORT POLICY

NATIONAL'S PRODUCTS ARE NOT AUTHORIZED FOR USE AS CRITICAL COMPONENTS IN LIFE SUPPORT DEVICES OR SYSTEMS WITHOUT THE EXPRESS WRITTEN APPROVAL OF THE PRESIDENT AND GENERAL COUNSEL OF NATIONAL SEMICONDUCTOR CORPORATION. As used herein:

1. Life support devices or systems are devices or systems which, (a) are intended for surgical implant into the body, or (b) support or sustain life, and whose failure to perform when properly used in accordance with instructions for use provided in the labeling, can be reasonably expected to result in a significant injury to the user.
2. A critical component is any component of a life support device or system whose failure to perform can be reasonably expected to cause the failure of the life support device or system, or to affect its safety or effectiveness.



National Semiconductor Corporation
Americas
Email: support@nsc.com

www.national.com

National Semiconductor Europe
Fax: +49 (0) 180-530 85 86
Email: europe.support@nsc.com
Deutsch Tel: +49 (0) 69 9508 6208
English Tel: +44 (0) 870 24 0 2171
Français Tel: +33 (0) 1 41 91 8790

National Semiconductor Asia Pacific Customer Response Group
Tel: 65-2544466
Fax: 65-2504466
Email: ap.support@nsc.com

National Semiconductor Japan Ltd.
Tel: 81-3-5639-7560
Fax: 81-3-5639-7507