



STB120N4LF6 STD120N4LF6

N-channel 40 V, 3.1 mΩ, 80 A DPAK, D²PAK
STripFET™ VI DeepGATE™ Power MOSFET

Features

Order codes	V _{DSS}	R _{DS(on)} max	I _D
STB120N4LF6	40 V	4.0 mΩ	80 A
STD120N4LF6	40 V	4.0 mΩ	80 A

- Logic level drive
- 100% avalanche tested

Application

- Switching applications
 - Automotive

Description

This product is a 40 V N-channel STripFET™ VI Power MOSFET based on the ST's proprietary STripFET™ technology, with a new gate structure. The resulting Power MOSFET exhibits the lowest R_{DS(on)} in all packages.

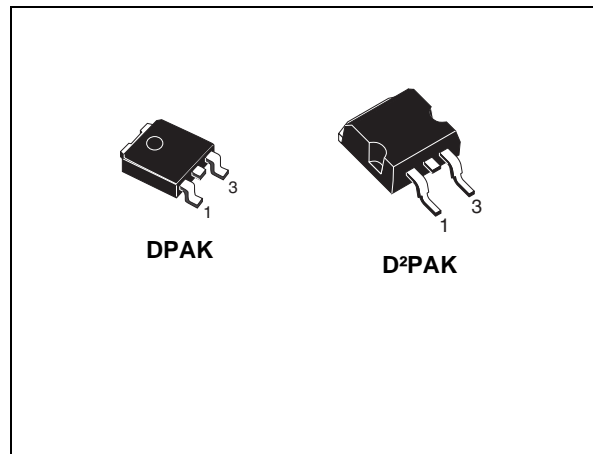

Figure 1. Internal schematic diagram

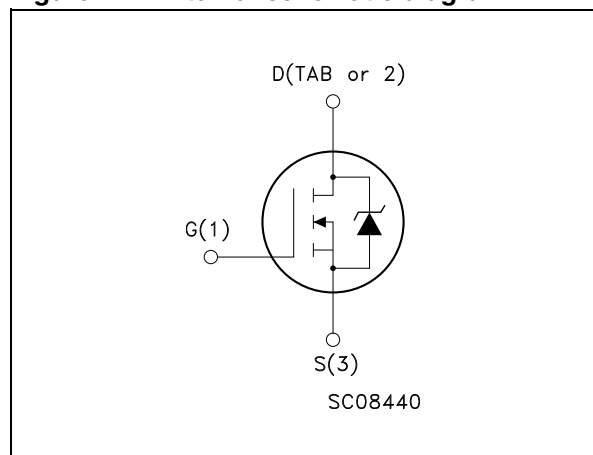

Table 1. Device summary

Order codes	Marking	Packages	Packaging
STB120N4LF6	120N4LF6	D ² PAK	Tape and reel
STD120N4LF6		DPAK	

Contents

1	Electrical ratings	3
2	Electrical characteristics	4
2.1	Electrical characteristics (curves)	6
3	Test circuits	8
4	Package mechanical data	10
5	Packaging mechanical data	15
6	Revision history	18

1 Electrical ratings

Table 2. Absolute maximum ratings

Symbol	Parameter	Value	Unit
V_{DS}	Drain-source voltage ($V_{GS} = 0$)	40	V
V_{GS}	Gate-source voltage	± 20	V
$I_D^{(1)}$	Drain current (continuous) at $T_C = 25\text{ }^\circ\text{C}$	80	A
I_D	Drain current (continuous) at $T_C = 100\text{ }^\circ\text{C}$	80	A
$I_{DM}^{(2)}$	Drain current (pulsed)	320	A
P_{TOT}	Total dissipation at $T_C = 25\text{ }^\circ\text{C}$	110	W
T_{stg}	Storage temperature	-55 to 175	$^\circ\text{C}$
T_j	Operating junction temperature		

1. Limited by wire bonding
2. Pulse width limited by safe operating area

Table 3. Thermal resistance

Symbol	Parameter	Value		Unit
		DPAK	D ² PAK	
$R_{thj-case}$	Thermal resistance junction-case max	1.36		$^\circ\text{C}/\text{W}$
$R_{thj-pcb}$	Thermal resistance junction-pcb max ⁽¹⁾	50	35	$^\circ\text{C}/\text{W}$

1. When mounted on 1 inch² 2 oz. Cu board.

Table 4. Avalanche data

Symbol	Parameter	Value	Unit
I_{AV}	Not-repetitive avalanche current	40	A
$E_{AS}^{(1)}$	Single pulse avalanche energy	394	mJ

1. Starting $T_j = 25\text{ }^\circ\text{C}$, $I_D = 40\text{ A}$, $V_{DD} = 25\text{ V}$

2 Electrical characteristics

($T_{CASE} = 25\text{ °C}$ unless otherwise specified)

Table 5. Static

Symbol	Parameter	Test conditions	Min.	Typ.	Max.	Unit
$V_{(BR)DSS}$	Drain-source breakdown Voltage	$I_D = 250\ \mu\text{A}$, $V_{GS} = 0$	40	-		V
I_{DSS}	Zero gate voltage drain current ($V_{GS} = 0$)	$V_{DS} = 20\text{ V}$ $V_{DS} = 20\text{ V}$, $T_c = 125\text{ °C}$		-	1 10	μA μA
I_{GSS}	Gate body leakage current ($V_{DS} = 0$)	$V_{GS} = \pm 20\text{ V}$		-	± 100	nA
$V_{GS(th)}$	Gate threshold voltage	$V_{DS} = V_{GS}$, $I_D = 250\ \mu\text{A}$	1	-	3	V
$R_{DS(on)}$	Static drain-source on resistance	$V_{GS} = 5\text{ V}$, $I_D = 40\text{ A}$		3.6	5.0	m Ω
		$V_{GS} = 10\text{ V}$, $I_D = 40\text{ A}$		3.1	4.0	m Ω

Table 6. Dynamic

Symbol	Parameter	Test conditions	Min	Typ.	Max.	Unit
C_{iss}	Input capacitance	$V_{DS} = 25\text{ V}$, $f = 1\text{ MHz}$, $V_{GS} = 0\text{ V}$	-	4300	-	pF
C_{oss}	Output capacitance			650		
C_{rss}	Reverse transfer capacitance			375		
Q_g	Total gate charge	$V_{DD} = 20\text{ V}$, $I_D = 80\text{ A}$	-	80	-	nC
Q_{gs}	Gate-source charge	$V_{GS} = 10\text{ V}$		15		
Q_{gd}	Gate-drain charge	(see Figure 14)		15		
R_G	Intrinsic gate resistance	$f = 1\text{ MHz}$ open drain		1.35		Ω

Table 7. Switching on/off (inductive load)

Symbol	Parameter	Test conditions	Min.	Typ.	Max.	Unit
$t_{d(on)}$	Turn-on delay time	$V_{DD} = 20\text{ V}$, $I_D = 40\text{ A}$, $R_G = 4.7\ \Omega$, $V_{GS} = 10\text{ V}$ <i>Figure 15</i>	-	15	-	ns
t_r	Rise time			95		ns
$t_{d(off)}$	Turn-off delay time	<i>Figure 15</i>	-	125	-	ns
t_f	Fall time			45		ns

Table 8. Source drain diode

Symbol	Parameter	Test conditions	Min.	Typ.	Max.	Unit
I_{SD}	Source-drain current		-		80	A
$I_{SDM}^{(1)}$	Source-drain current (pulsed)				320	A
$V_{SD}^{(2)}$	Forward on voltage	$I_{SD} = 40\text{ A}$, $V_{GS} = 0$	-		1.1	V
t_{rr}	Reverse recovery time	$I_{SD} = 80\text{ A}$, $di/dt = 100\text{ A}/\mu\text{s}$, $V_{DD} = 32\text{ V}$, $T_J = 150\text{ }^\circ\text{C}$ <i>Figure 17</i>	-	50		ns
Q_{rr}	Reverse recovery charge			85		nC
I_{RRM}	Reverse recovery current			3.5		A

1. Pulse width limited by safe operating area
2. Pulsed: pulse duration = 300 μs , duty cycle 1.5%

2.1 Electrical characteristics (curves)

Figure 2. Safe operating area

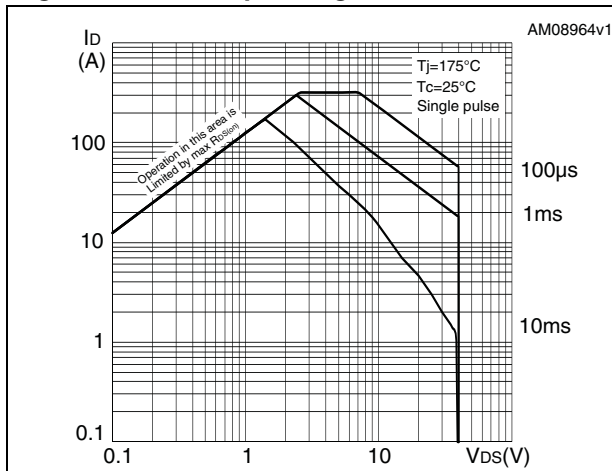

Figure 3. Thermal impedance

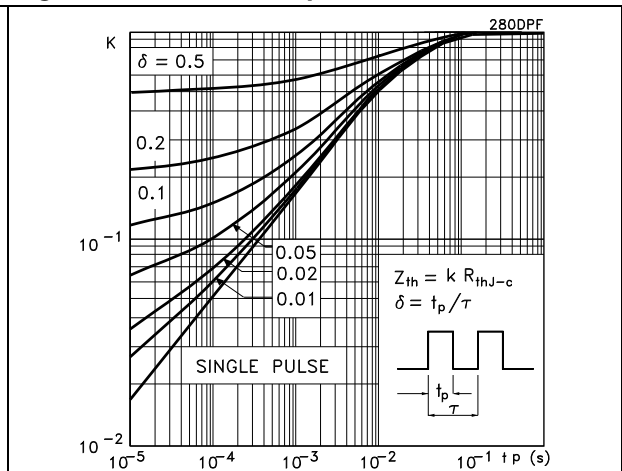

Figure 4. Output characteristics

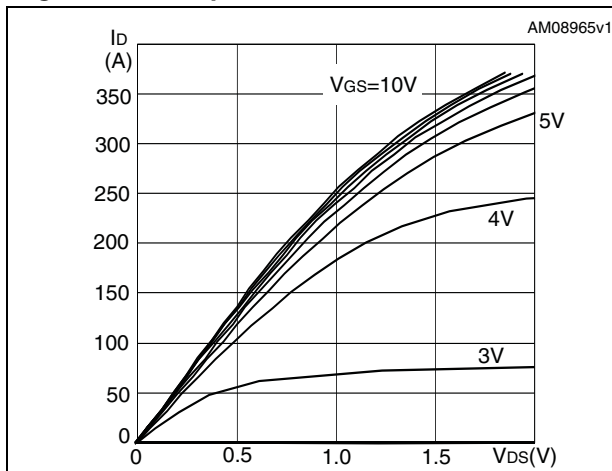

Figure 5. Transfer characteristics

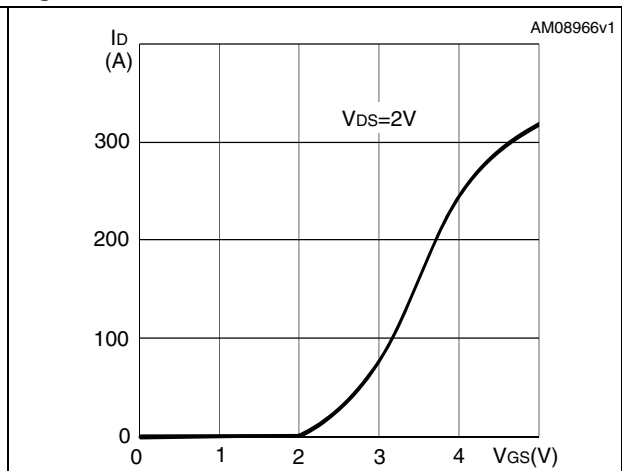

Figure 6. Normalized BV_{DSS} vs temperature

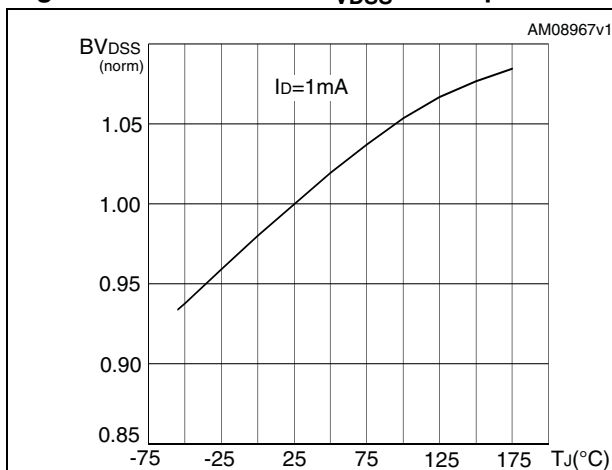

Figure 7. Static drain-source on resistance

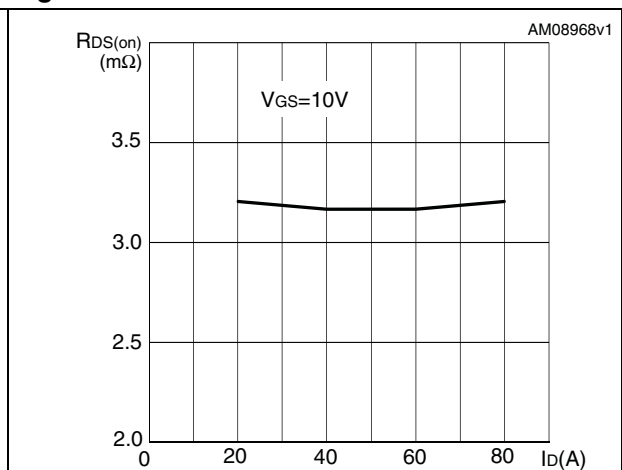

Figure 8. Gate charge vs gate-source voltage Figure 9. Capacitance variations

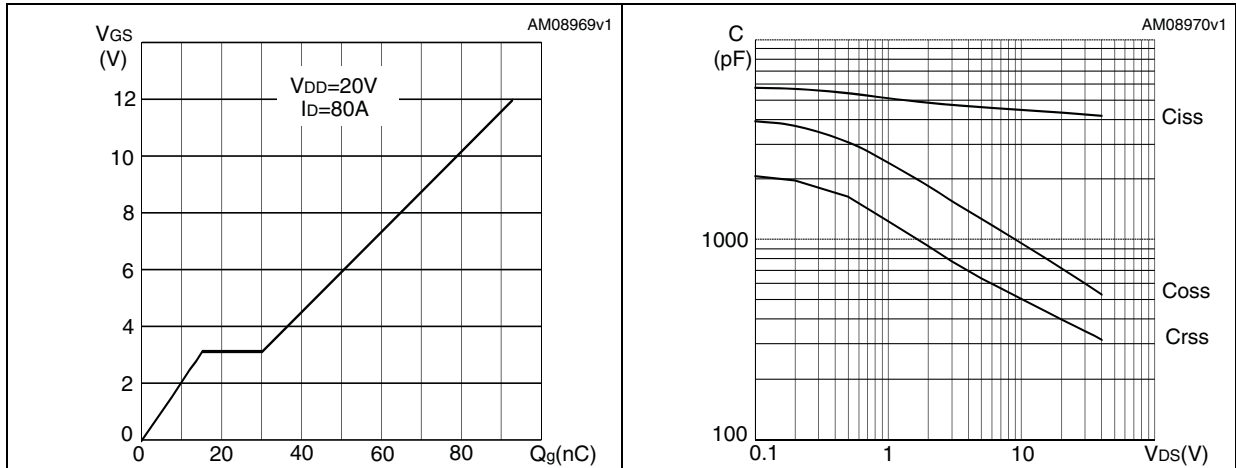

Figure 10. Normalized gate threshold voltage vs temperature Figure 11. Normalized on resistance vs temperature

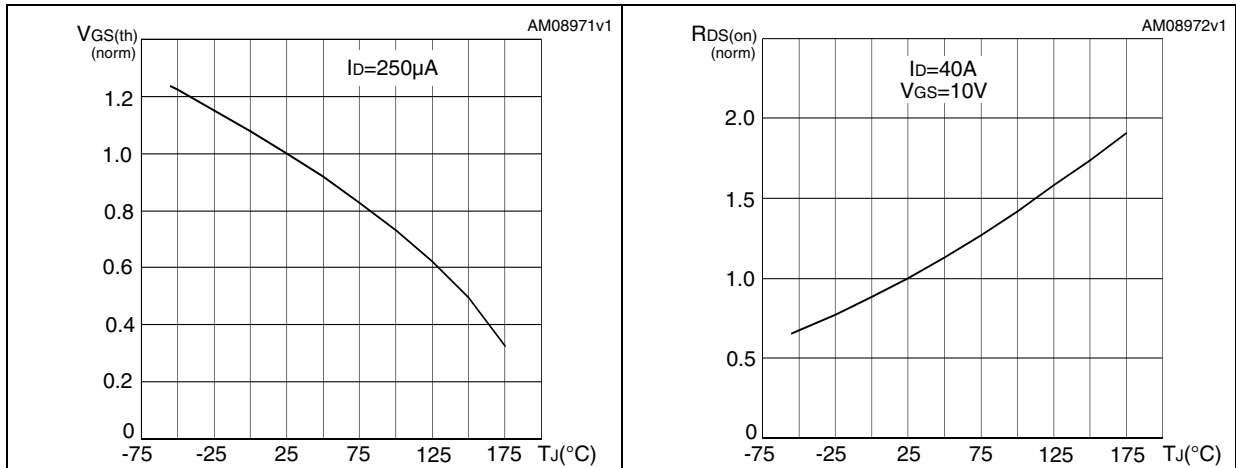
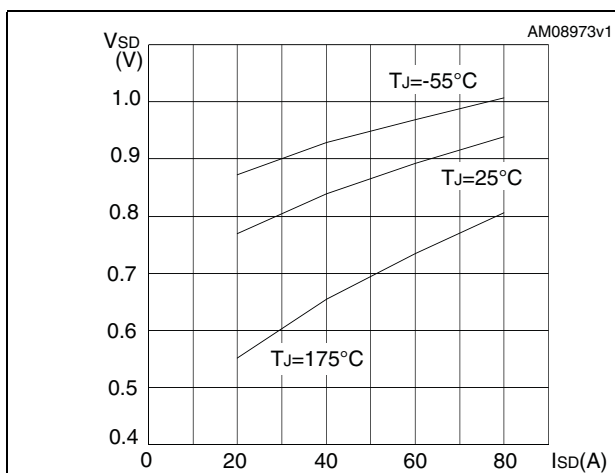

Figure 12. Source-drain diode forward characteristics



3 Test circuits

Figure 13. Switching times test circuit for resistive load



Figure 14. Gate charge test circuit



Figure 15. Test circuit for inductive load switching and diode recovery times



Figure 16. Unclamped inductive load test circuit



Figure 17. Unclamped inductive waveform

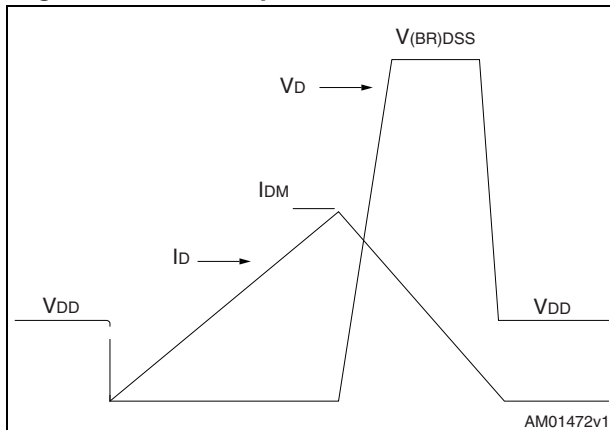
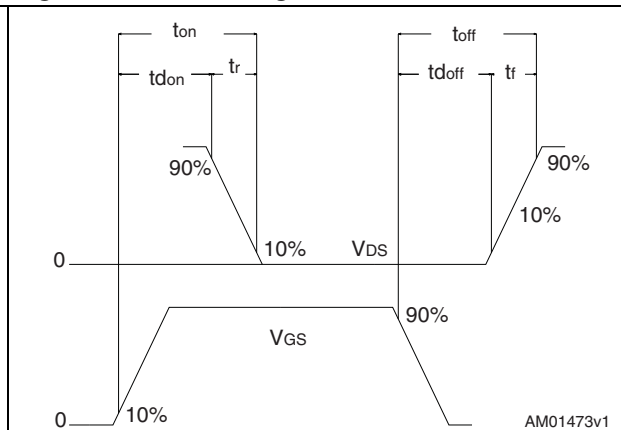

Figure 18. Switching time waveform



4 Package mechanical data

In order to meet environmental requirements, ST offers these devices in different grades of ECOPACK® packages, depending on their level of environmental compliance. ECOPACK® specifications, grade definitions and products status are available at: www.st.com. ECOPACK is an ST trademark.

Table 9. D²PAK (TO-263) mechanical data

Dim.	mm		
	Min.	Typ.	Max.
A	4.40		4.60
A1	0.03		0.23
b	0.70		0.93
b2	1.14		1.70
c	0.45		0.60
c2	1.23		1.36
D	8.95		9.35
D1	7.50		
E	10		10.40
E1	8.50		
e		2.54	
e1	4.88		5.28
H	15		15.85
J1	2.49		2.69
L	2.29		2.79
L1	1.27		1.40
L2	1.30		1.75
R		0.4	
V2	0°		8°

Figure 19. D²PAK (TO-263) drawing

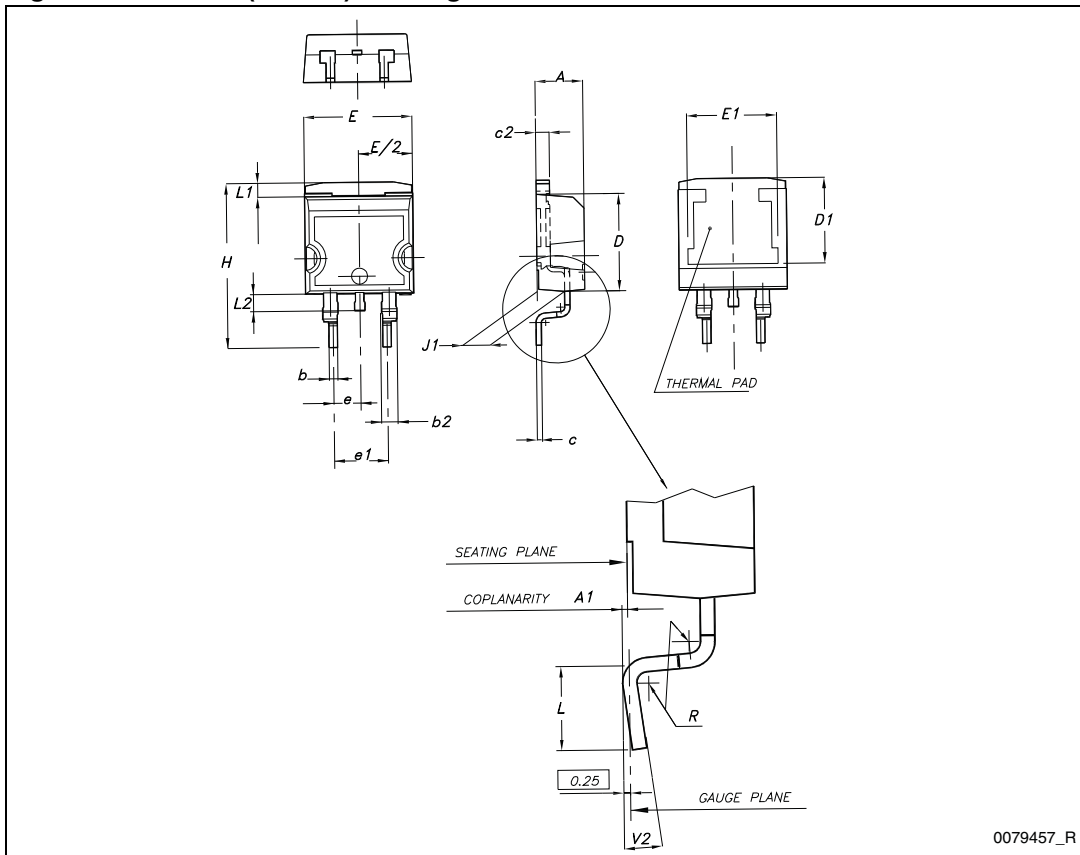
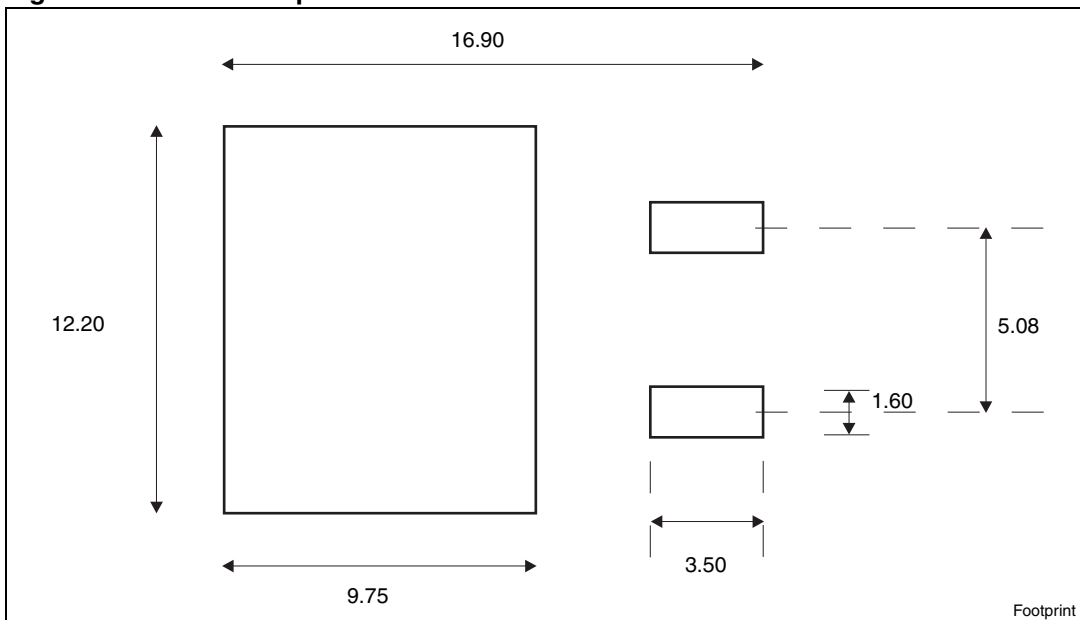

Figure 20. D²PAK footprint^(a)



a. All dimension are in millimeters

Table 10. DPAK (TO-252) mechanical data

Dim.	mm		
	Min.	Typ.	Max.
A	2.20		2.40
A1	0.90		1.10
A2	0.03		0.23
b	0.64		0.90
b4	5.20		5.40
c	0.45		0.60
c2	0.48		0.60
D	6.00		6.20
D1		5.10	
E	6.40		6.60
E1		4.70	
e		2.28	
e1	4.40		4.60
H	9.35		10.10
L	1		
L1		2.80	
L2		0.80	
L4	0.60		1
R		0.20	
V2	0°		8°

Figure 21. DPAK (TO-252) drawing

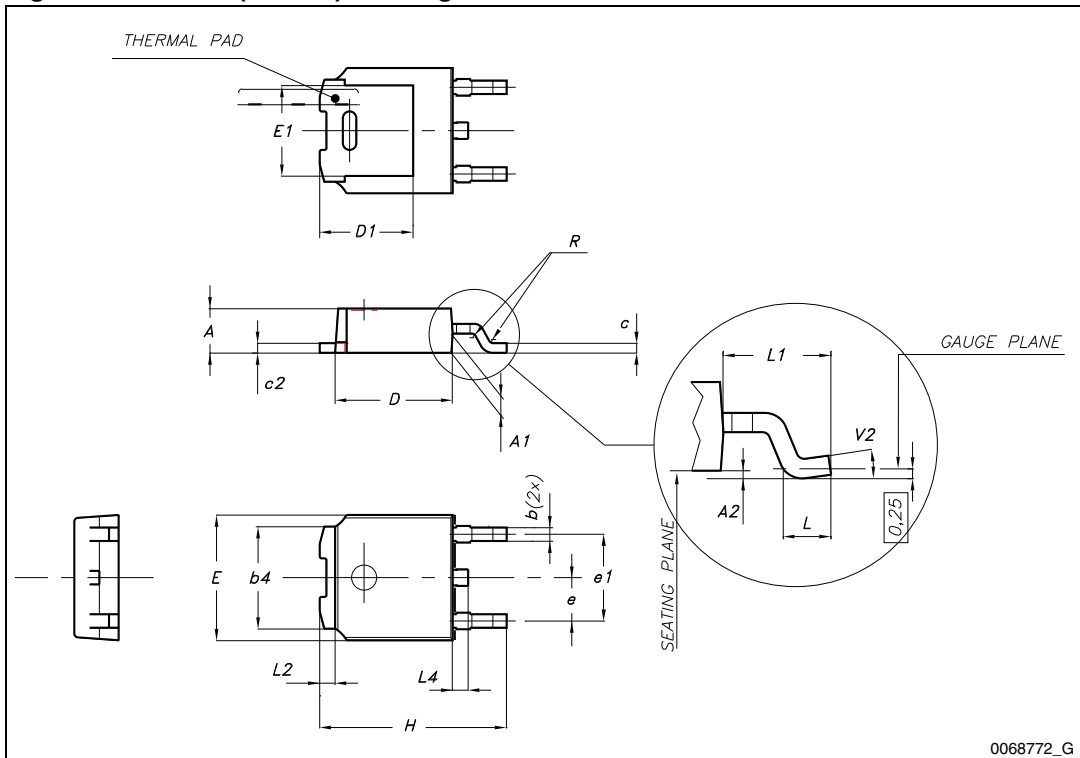
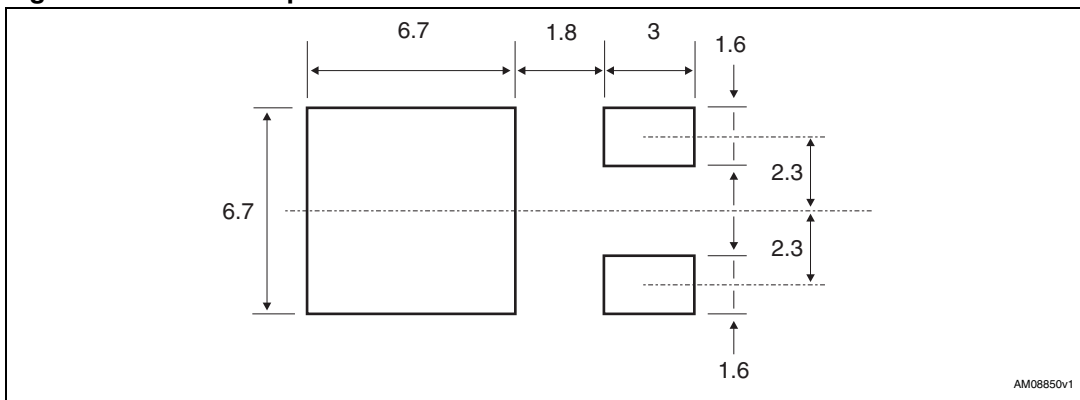

Figure 22. DPAK footprint^(b)



b. All dimension are in millimeters

5 Packaging mechanical data

Table 11. D²PAK (TO-263) tape and reel mechanical data

Tape			Reel		
Dim.	mm		Dim.	mm	
	Min.	Max.		Min.	Max.
A0	10.5	10.7	A		330
B0	15.7	15.9	B	1.5	
D	1.5	1.6	C	12.8	13.2
D1	1.59	1.61	D	20.2	
E	1.65	1.85	G	24.4	26.4
F	11.4	11.6	N	100	
K0	4.8	5.0	T		30.4
P0	3.9	4.1			
P1	11.9	12.1		Base qty	1000
P2	1.9	2.1		Bulk qty	1000
R	50				
T	0.25	0.35			
W	23.7	24.3			

Table 12. DPAK (TO-252) tape and reel mechanical data

Tape			Reel		
Dim.	mm		Dim.	mm	
	Min.	Max.		Min.	Max.
A0	6.8	7	A		330
B0	10.4	10.6	B	1.5	
B1		12.1	C	12.8	13.2
D	1.5	1.6	D	20.2	
D1	1.5		G	16.4	18.4
E	1.65	1.85	N	50	
F	7.4	7.6	T		22.4
K0	2.55	2.75			
P0	3.9	4.1	Base qty.		2500
P1	7.9	8.1	Bulk qty.		2500
P2	1.9	2.1			
R	40				
T	0.25	0.35			
W	15.7	16.3			

Figure 23. Tape for D²PAK(TO-263) and DPAK (TO-252)

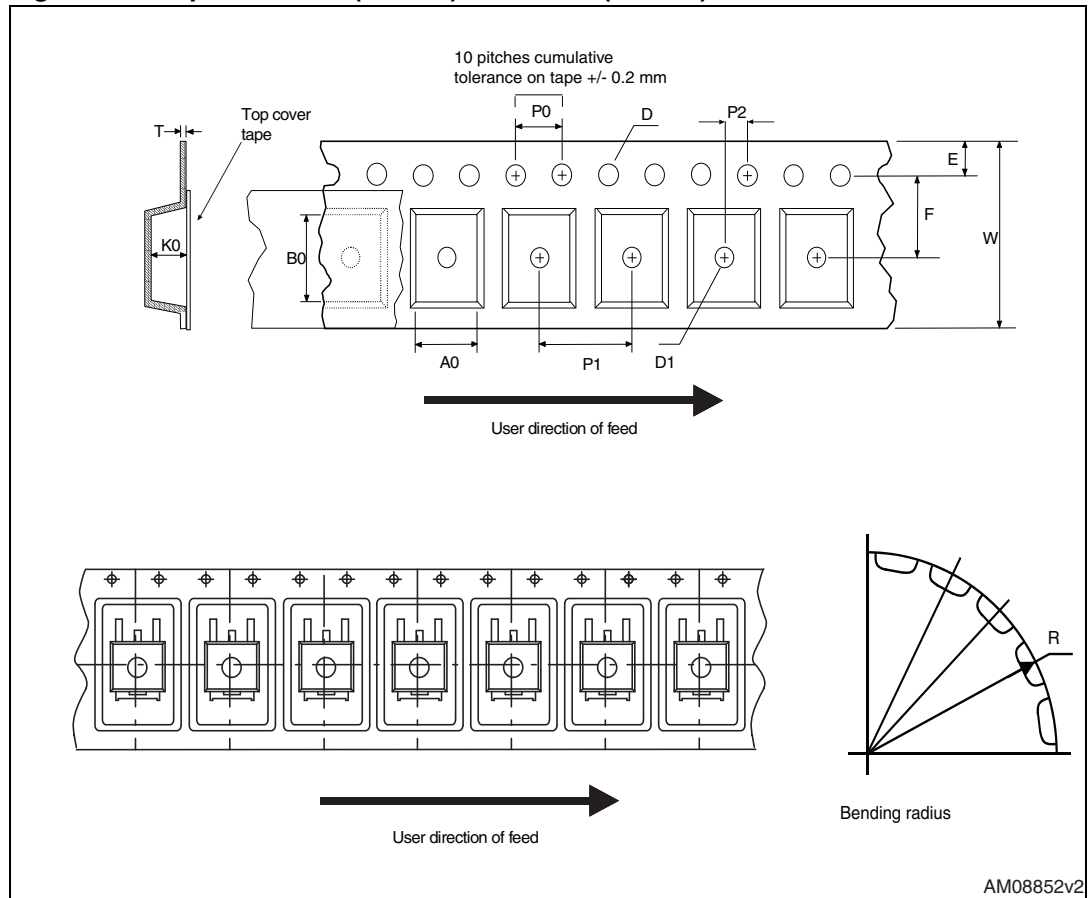
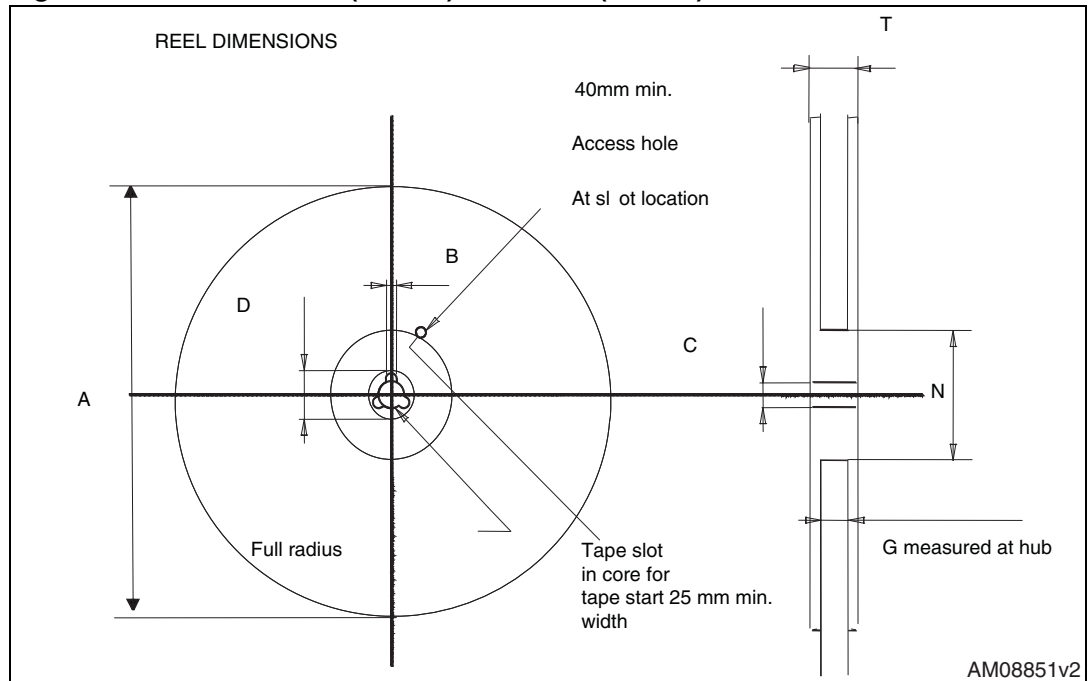

Figure 24. Reel for D²PAK(TO-263) and DPAK (TO-252)



6 Revision history

Table 13. Document revision history

Date	Revision	Changes
14-Dec-2009	1	First release
23-Feb-2011	2	Document status promoted from preliminary data to datasheet.

Please Read Carefully:

Information in this document is provided solely in connection with ST products. STMicroelectronics NV and its subsidiaries ("ST") reserve the right to make changes, corrections, modifications or improvements, to this document, and the products and services described herein at any time, without notice.

All ST products are sold pursuant to ST's terms and conditions of sale.

Purchasers are solely responsible for the choice, selection and use of the ST products and services described herein, and ST assumes no liability whatsoever relating to the choice, selection or use of the ST products and services described herein.

No license, express or implied, by estoppel or otherwise, to any intellectual property rights is granted under this document. If any part of this document refers to any third party products or services it shall not be deemed a license grant by ST for the use of such third party products or services, or any intellectual property contained therein or considered as a warranty covering the use in any manner whatsoever of such third party products or services or any intellectual property contained therein.

UNLESS OTHERWISE SET FORTH IN ST'S TERMS AND CONDITIONS OF SALE ST DISCLAIMS ANY EXPRESS OR IMPLIED WARRANTY WITH RESPECT TO THE USE AND/OR SALE OF ST PRODUCTS INCLUDING WITHOUT LIMITATION IMPLIED WARRANTIES OF MERCHANTABILITY, FITNESS FOR A PARTICULAR PURPOSE (AND THEIR EQUIVALENTS UNDER THE LAWS OF ANY JURISDICTION), OR INFRINGEMENT OF ANY PATENT, COPYRIGHT OR OTHER INTELLECTUAL PROPERTY RIGHT.

UNLESS EXPRESSLY APPROVED IN WRITING BY AN AUTHORIZED ST REPRESENTATIVE, ST PRODUCTS ARE NOT RECOMMENDED, AUTHORIZED OR WARRANTED FOR USE IN MILITARY, AIR CRAFT, SPACE, LIFE SAVING, OR LIFE SUSTAINING APPLICATIONS, NOR IN PRODUCTS OR SYSTEMS WHERE FAILURE OR MALFUNCTION MAY RESULT IN PERSONAL INJURY, DEATH, OR SEVERE PROPERTY OR ENVIRONMENTAL DAMAGE. ST PRODUCTS WHICH ARE NOT SPECIFIED AS "AUTOMOTIVE GRADE" MAY ONLY BE USED IN AUTOMOTIVE APPLICATIONS AT USER'S OWN RISK.

Resale of ST products with provisions different from the statements and/or technical features set forth in this document shall immediately void any warranty granted by ST for the ST product or service described herein and shall not create or extend in any manner whatsoever, any liability of ST.

ST and the ST logo are trademarks or registered trademarks of ST in various countries.

Information in this document supersedes and replaces all information previously supplied.

The ST logo is a registered trademark of STMicroelectronics. All other names are the property of their respective owners.

© 2011 STMicroelectronics - All rights reserved

STMicroelectronics group of companies

Australia - Belgium - Brazil - Canada - China - Czech Republic - Finland - France - Germany - Hong Kong - India - Israel - Italy - Japan - Malaysia - Malta - Morocco - Philippines - Singapore - Spain - Sweden - Switzerland - United Kingdom - United States of America

www.st.com