

TLE214x, TLE214xA EXCALIBUR LOW-NOISE HIGH-SPEED PRECISION OPERATIONAL AMPLIFIERS

SLOS183C – FEBRUARY 1997 – REVISED JUNE 2006

- **Low Noise**
10 Hz . . . 15 nV/ $\sqrt{\text{Hz}}$
1 kHz . . . 10.5 nV/ $\sqrt{\text{Hz}}$
- **10000-pF Load Capability**
- **20-mA Min Short-Circuit Output Current**
- **27-V/ μs Min Slew Rate**
- **High Gain-Bandwidth Product . . . 5.9 MHz**
- **Low V_{IO} . . . 500 μV Max at 25°C**
- **Single or Split Supply . . . 4 V to 44 V**
- **Fast Settling Time**
340 ns to 0.1%
400 ns to 0.01%
- **Saturation Recovery . . . 150 ns**
- **Large Output Swing**
 $V_{\text{CC-}} + 0.1 \text{ V}$ to $V_{\text{CC+}} - 1 \text{ V}$

description

The TLE214x and TLE214xA devices are high-performance, internally compensated operational amplifiers built using Texas Instruments complementary bipolar Excalibur process. The TLE214xA is a tighter offset voltage grade of the TLE214x. Both are pin-compatible upgrades to standard industry products.

The design incorporates an input stage that simultaneously achieves low audio-band noise of 10.5 nV/ $\sqrt{\text{Hz}}$ with a 10-Hz 1/f corner and symmetrical 40-V/ μs slew rate typically with loads up to 800 pF. The resulting low distortion and high power bandwidth are important in high-fidelity audio applications. A fast settling time of 340 ns to 0.1% of a 10-V step with a 2-k Ω /100-pF load is useful in fast actuator/positioning drivers. Under similar test conditions, settling time to 0.01% is 400 ns.

The devices are stable with capacitive loads up to 10 nF, although the 6-MHz bandwidth decreases to 1.8 MHz at this high loading level. As such, the TLE214x and TLE214xA are useful for low-droop sample-and-holds and direct buffering of long cables, including 4-mA to 20-mA current loops.

The special design also exhibits an improved insensitivity to inherent integrated circuit component mismatches as is evidenced by a 500- μV maximum offset voltage and 1.7- $\mu\text{V}/^\circ\text{C}$ typical drift. Minimum common-mode rejection ratio and supply-voltage rejection ratio are 85 dB and 90 dB, respectively.

Device performance is relatively independent of supply voltage over the $\pm 2\text{-V}$ to $\pm 22\text{-V}$ range. Inputs can operate between $V_{\text{CC-}} - 0.3$ to $V_{\text{CC+}} - 1.8 \text{ V}$ without inducing phase reversal, although excessive input current may flow out of each input exceeding the lower common-mode input range. The all-npn output stage provides a nearly rail-to-rail output swing of $V_{\text{CC-}} - 0.1$ to $V_{\text{CC+}} - 1 \text{ V}$ under light current-loading conditions. The device can sustain shorts to either supply since output current is internally limited, but care must be taken to ensure that maximum package power dissipation is not exceeded.

Both versions can also be used as comparators. Differential inputs of $V_{\text{CC}\pm}$ can be maintained without damage to the device. Open-loop propagation delay with TTL supply levels is typically 200 ns. This gives a good indication as to output stage saturation recovery when the device is driven beyond the limits of recommended output swing.

Both the TLE214x and TLE214xA are available in a wide variety of packages, including both the industry-standard 8-pin small-outline version and chip form for high-density system applications. The C-suffix devices are characterized for operation from 0°C to 70°C, I-suffix devices from -40°C to 105°C, and M-suffix devices over the full military temperature range of -55°C to 125°C.



Please be aware that an important notice concerning availability, standard warranty, and use in critical applications of Texas Instruments semiconductor products and disclaimers thereto appears at the end of this data sheet.

PRODUCTION DATA information is current as of publication date. Products conform to specifications per the terms of Texas Instruments standard warranty. Production processing does not necessarily include testing of all parameters.



POST OFFICE BOX 655303 • DALLAS, TEXAS 75265

Copyright © 1997 – 2006, Texas Instruments Incorporated

TLE214x, TLE214xA EXCALIBUR LOW-NOISE HIGH-SPEED PRECISION OPERATIONAL AMPLIFIERS

SLOS183C – FEBRUARY 1997 – REVISED JUNE 2006

TLE2141 AVAILABLE OPTIONS

T _A	V _{IO} max AT 25°C	PACKAGED DEVICES		
		SMALL OUT- LINE† (D)	CERAMIC DIP (JG)	PLASTIC DIP (P)
0°C to 70°C	500 μV 900 μV	TLE2141ACD TLE2141CD	—	TLE2141ACP TLE2141CP
–40°C to 105°C	500 μV 900 μV	TLE2141AID TLE2141ID	—	TLE2141AIP TLE2141IP
–55°C to 125°C	500 μV 900 μV	— TLE2141MD	TLE2141AMJG TLE2141MJG	— —

† The D packages are available taped and reeled. Add R suffix to device type (e.g., TLE2141ACDR).

TLE2142 AVAILABLE OPTIONS

T _A	V _{IO} max AT 25°C	PACKAGED DEVICES					
		SMALL OUTLINE† (D)	CHIP CARRIER (FK)	CERAMIC DIP (JG)	PLASTIC DIP (P)	TSSOP‡ (PW)	CERAMIC FLAT PACK (U)
0°C to 70°C	750 μV 1200 μV	TLE2142ACD TLE2142CD	— —	— —	TLE2142ACP TLE2142CP	— TLE2142CPWLE	— —
–40°C to 105°C	750 μV 1200 μV	TLE2142AID TLE2142ID	— —	— —	TLC2142AIP TLC2142IP	— —	— —
–55°C to 125°C	750 μV 1200 μV	TLE2142AMD TLE2142MD	TLE2142AMFK TLE2142MFK	TLE2142AMJG TLE2142MJG	— —	— —	TLE2142AMU TLE2142MU

† The D packages are available taped and reeled. Add R suffix to device type (e.g., TLC2142ACDR).

‡ The PW packages are available left-ended taped and reeled. Add LE the suffix to device type (e.g., TLC2142CPWLE).

TLE2144 AVAILABLE OPTIONS

T _A	V _{IO} max AT 25°C	PACKAGED DEVICES			
		SMALL OUTLINE† (DW)	CHIP CARRIER (FK)	CERAMIC DIP (J)	PLASTIC DIP (N)
0°C to 70°C	1.5 mV 2.4 mV	— TLE2144CDW	— —	— —	TLE2144ACN TLE2144CN
–40°C to 105°C	1.5 mV 2.4 mV	— TLE2144IDW	— —	— —	TLE2144AIN TLE2144IN
–55°C to 125°C	1.5 mV 2.5 mV	— TLE2144MDW	TLE2144AMFK TLE2144MFK	TLE2144AMJ TLE2144MJ	— —

† The DW packages are available taped and reeled. Add R suffix to device type (e.g., TLE2144CDWR).

symbol

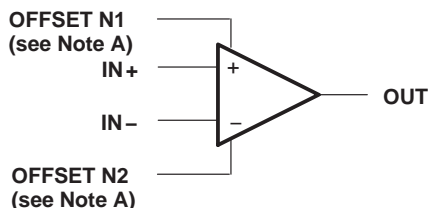

NOTES: A. OFFSET N1 AND OFFSET N2 are only available on the TLE2241x devices.

TLE214x, TLE214xA

EXCALIBUR LOW-NOISE HIGH-SPEED PRECISION OPERATIONAL AMPLIFIERS

SLOS183C – FEBRUARY 1997 – REVISED JUNE 2006

TLE2141
D, JG, OR P PACKAGE
(TOP VIEW)

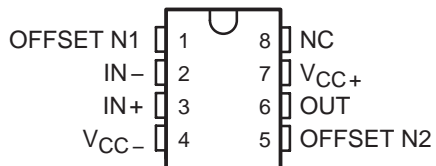

TLE2142
PW PACKAGE
(TOP VIEW)

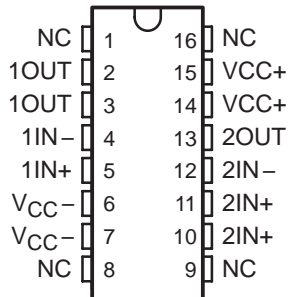

TLE2142
D, JG, OR P PACKAGE
(TOP VIEW)

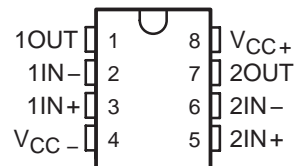

TLE2141
FK PACKAGE
(TOP VIEW)

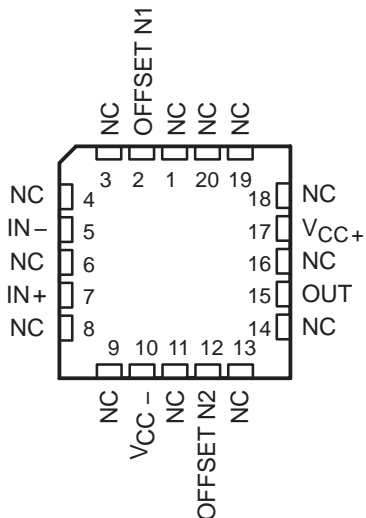

TLE2142
U PACKAGE
(TOP VIEW)

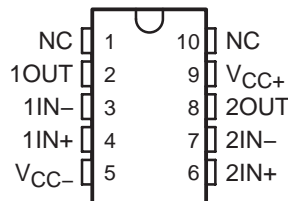

TLE2142
FK PACKAGE
(TOP VIEW)

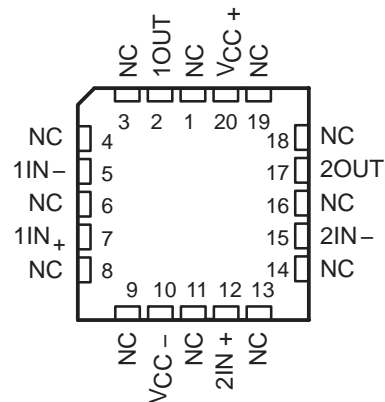

TLE2144
DW PACKAGE
(TOP VIEW)

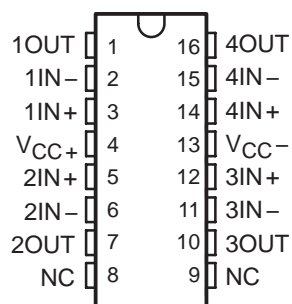

TLE2144
J OR N PACKAGE
(TOP VIEW)

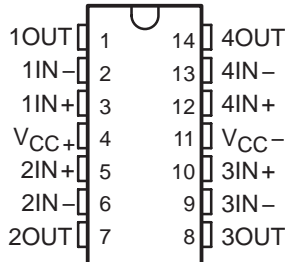

TLE2144
FK PACKAGE
(TOP VIEW)

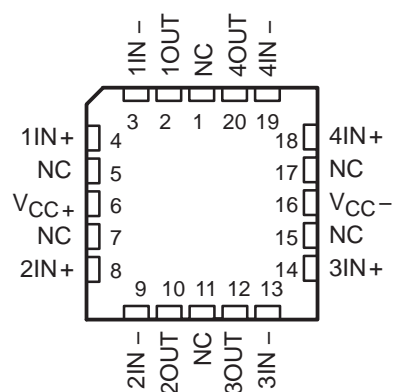

NC – No internal connection

TLE214x, TLE214xA, TLE214xY EXCALIBUR LOW-NOISE HIGH-SPEED PRECISION OPERATIONAL AMPLIFIERS

SLOS183C – FEBRUARY 1997 – REVISED JUNE 2006

equivalent schematic

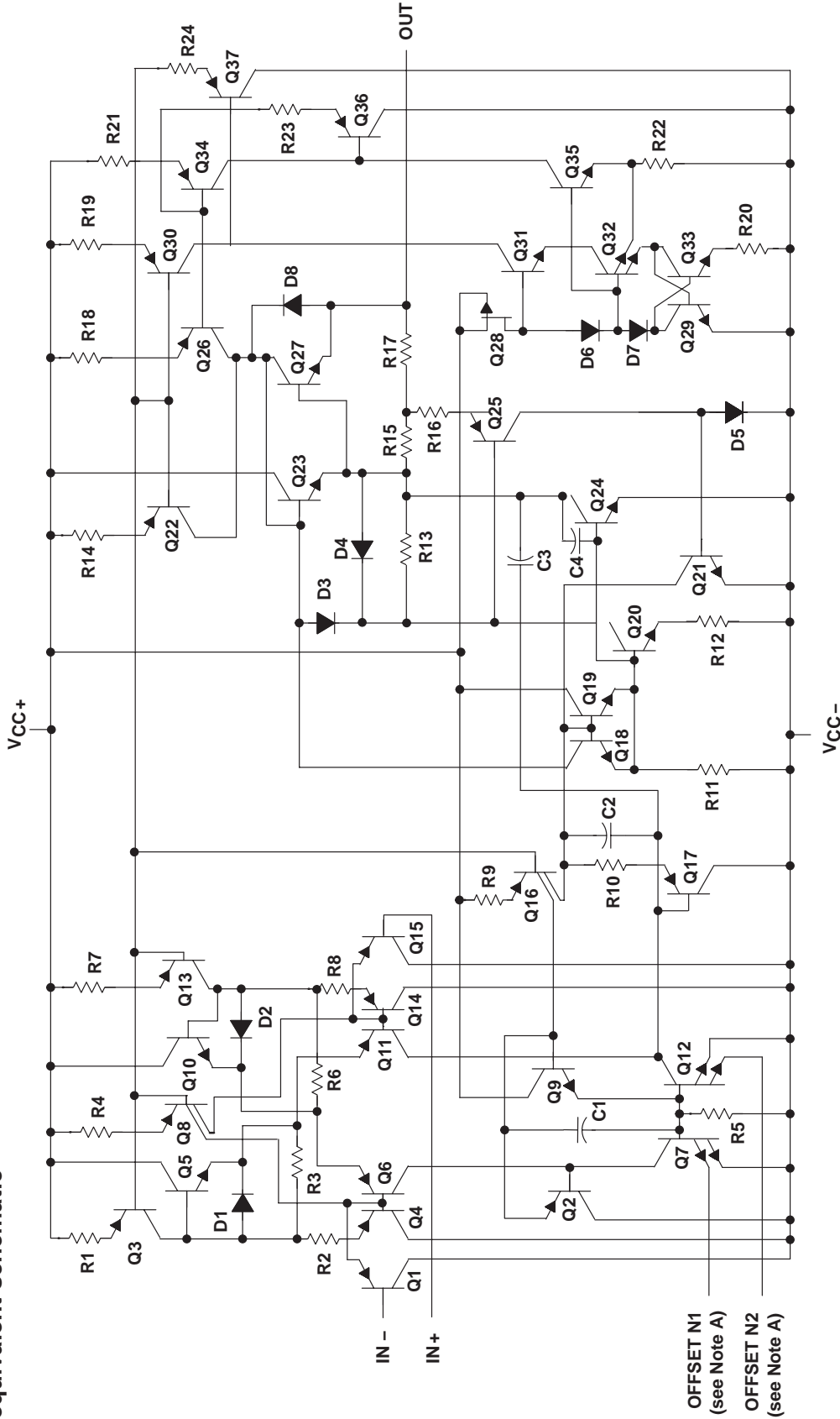

OFFSET N1
(see Note A)
OFFSET N2
(see Note A)

NOTE A: OFFSET N1 AND OFFSET N2 are only available on the TLE2241x devices.

COMPONENT	ACTUAL DEVICE COMPONENT COUNT		
	TLE2241	TLE2242	TLE2244
Transistors	46	65	130
Resistors	24	43	86
Diodes	8	14	28
Capacitors	4	8	16
Epi-FET	1	1	2

TLE214x, TLE214xA
EXCALIBUR LOW-NOISE HIGH-SPEED
PRECISION OPERATIONAL AMPLIFIERS

SLOS183C – FEBRUARY 1997 – REVISED JUNE 2006

absolute maximum ratings over operating free-air temperature range (unless otherwise noted)†

Supply voltage, V_{CC+} (see Note 1)	22 V
Supply voltage, V_{CC-}	–22 V
Differential input voltage, V_{ID} (see Note 2)	±44 V
Input voltage range, V_I (any input)	V_{CC+} to $V_{CC-} - 0.3$ V
Input current, I_I (each input)	±1 mA
Output current, I_O	±80 mA
Total current into V_{CC+}	80 mA
Total current out of V_{CC-}	80 mA
Duration of short-circuit current at (or below) 25°C (see Note 3)	unlimited
Package thermal impedance, θ_{JA} (see Notes 4 and 5): D package	97.1°C/W
DW package	57.3°C/W
N package	79.7°C/W
P package	84.6°C/W
PW package	108.4°C/W
Package thermal impedance, θ_{JC} (see Notes 4 and 5): FK package	5.6°C/W
J package	15.1°C/W
JG package	14.5°C/W
U package	14.7°C/W
Operating free-air temperature range, T_A : C suffix	0°C to 70°C
I suffix	–40°C to 105°C
M suffix	–55°C to 125°C
Storage temperature range	–65°C to 150°C
Case temperature for 60 seconds: FK package	260°C
Lead temperature 1,6 mm (1/16 inch) from case for 10 seconds: D, DW, N, P, or PW package	260°C
Lead temperature 1,6 mm (1/16 inch) from case for 60 seconds: J or JG package	300°C

† Stresses beyond those listed under “absolute maximum ratings” may cause permanent damage to the device. These are stress ratings only, and functional operation of the device at these or any other conditions beyond those indicated under “recommended operating conditions” is not implied. Exposure to absolute-maximum-rated conditions for extended periods may affect device reliability.

- NOTES:
1. All voltage values, except differential voltages, are with respect to the midpoint between V_{CC+} and V_{CC-} .
 2. Differential voltages are at $IN+$ with respect to $IN-$. Excessive current flows, if input, are brought below $V_{CC-} - 0.3$ V.
 3. The output may be shorted to either supply. Temperature and/or supply voltages must be limited to ensure that the maximum dissipation rating is not exceeded.
 4. Maximum power dissipation is a function of $T_{J(max)}$, θ_{JA} , and T_A . The maximum allowable power dissipation at any allowable ambient temperature is $P_D = (T_{J(max)} - T_A)/\theta_{JA}$. Operating at the absolute maximum T_J of 150°C can affect reliability.
 5. The package thermal impedance is calculated in accordance with JESD 51-7 (plastic) or MIL-STD-883 Method 1012 (ceramic).

recommended operating conditions

		C SUFFIX		I SUFFIX		M SUFFIX		UNIT
		MIN	MAX	MIN	MAX	MIN	MAX	
Supply voltage, $V_{CC\pm}$		±2	±22	±2	±22	±2	±22	V
Common-mode input voltage, V_{IC}	$V_{CC} = 5$ V	0	2.9	0	2.7	0	2.7	V
	$V_{CC\pm} = \pm 15$ V	–15	12.9	–15	12.7	–15	12.7	
Operating free-air temperature, T_A		0	70	–40	105	–55	125	°C



TLE214x, TLE214xA EXCALIBUR LOW-NOISE HIGH-SPEED PRECISION OPERATIONAL AMPLIFIERS

SLOS183C – FEBRUARY 1997 – REVISED JUNE 2006

TLE2141C electrical characteristics at specified free-air temperature, $V_{CC} = 5\text{ V}$ (unless otherwise noted)

PARAMETER	TEST CONDITIONS	T_A †	TLE2141C			TLE2141AC			UNIT
			MIN	TYP	MAX	MIN	TYP	MAX	
V_{IO} Input offset voltage	$V_O = 2.5\text{ V}$ $V_{IC} = 2.5\text{ V}$ $R_S = 50\ \Omega$	25°C	225	1400		200	1000	μV	
		Full range			1700		1300		
α_{VIO} Temperature coefficient of input offset voltage		Full range	1.7			1.7		$\mu\text{V}/^\circ\text{C}$	
I_{IO} Input offset current		25°C	8	100		8	100	nA	
		Full range			150		150		
I_{IB} Input bias current		25°C	-0.8	-2		-0.8	-2	μA	
	Full range			-2.1		-2.1			
V_{ICR} Common-mode input voltage range	$R_S = 50\ \Omega$	25°C	0 to 3	-0.3 to 3.2		0 to 3	-0.3 to 3.2	V	
		Full range	0 to 2.9			0 to 2.9			
V_{OH} High-level output voltage	$I_{OH} = -150\ \mu\text{A}$	25°C	3.9	4.1		3.9	4.1	V	
		Full range	3.8			3.8			
	$I_{OH} = -1.5\text{ mA}$	25°C	3.8	4		3.8	4		
		Full range	3.7			3.7			
	$I_{OH} = -15\text{ mA}$	25°C	3.2	3.7		3.2	3.7		
		Full range	3.2			3.2			
V_{OL} Low-level output voltage	$I_{OL} = 150\ \mu\text{A}$	25°C		75	125		75	125	mV
		Full range			150		150		
	$I_{OL} = 1.5\text{ mA}$	25°C		150	225		150	225	
		Full range			250		250		
	$I_{OL} = 15\text{ mA}$	25°C		1.2	1.6		1.2	1.6	V
		Full range			1.7		1.7		
A_{VD} Large-signal differential voltage amplification	$V_{CC} = \pm 2.5\text{ V}$, $R_L = 2\text{ k}\Omega$, $V_O = 1\text{ V to } -1.5\text{ V}$	25°C	50	220		50	220	V/mV	
		Full range	25			25			
r_i Input resistance		25°C	70			70	$\text{M}\Omega$		
c_i Input capacitance		25°C	2.5			2.5	pF		
z_o Open-loop output impedance	$f = 1\text{ MHz}$	25°C	30			30	Ω		
CMRR Common-mode rejection ratio	$V_{IC} = V_{ICRmin}$, $R_S = 50\ \Omega$	25°C	85	118		85	118	dB	
		Full range	80			80			
k_{SVR} Supply-voltage rejection ratio ($\Delta V_{CC\pm} / \Delta V_{IO}$)	$V_{CC\pm} = \pm 2.5\text{ V to } \pm 15\text{ V}$, $R_S = 50\ \Omega$	25°C	90	106		90	106	dB	
		Full range	85			85			
I_{CC} Supply current	$V_O = 2.5\text{ V}$, No load, $V_{IC} = 2.5\text{ V}$	25°C	3.4	4.4		3.4	4.4	mA	
		Full range			4.6		4.6		

† Full range is 0°C to 70°C.



TLE214x, TLE214xA
EXCALIBUR LOW-NOISE HIGH-SPEED
PRECISION OPERATIONAL AMPLIFIERS

SLOS183C – FEBRUARY 1997 – REVISED JUNE 2006

TLE2141C operating characteristics, $V_{CC} = 5\text{ V}$, $T_A = 25^\circ\text{C}$

PARAMETER	TEST CONDITIONS	TLE2141C			TLE2141AC			UNIT
		MIN	TYP	MAX	MIN	TYP	MAX	
SR+	Positive slew rate	$A_{VD} = -1$, $C_L = 500\text{ pF}^\dagger$, $R_L = 2\text{ k}\Omega^\dagger$		45	45		V/ μs	
SR-	Negative slew rate			42	42			
t_s	Settling time	$A_{VD} = -1$, 2.5-V step	To 0.1%	0.16	0.16		μs	
			To 0.01%	0.22	0.22			
V_n	Equivalent input noise voltage	$R_S = 20\ \Omega$, $f = 10\text{ Hz}$	15	15		nV/ $\sqrt{\text{Hz}}$		
		$R_S = 20\ \Omega$, $f = 1\text{ kHz}$	10.5	10.5				
$V_{N(PP)}$	Peak-to-peak equivalent input noise voltage	$f = 0.1\text{ Hz to }1\text{ Hz}$	0.48	0.48		μV		
		$f = 0.1\text{ Hz to }10\text{ Hz}$	0.51	0.51				
I_n	Equivalent input noise current	$f = 10\text{ Hz}$	1.92	1.92		pA/ $\sqrt{\text{Hz}}$		
		$f = 1\text{ kHz}$	0.5	0.5				
THD + N	Total harmonic distortion plus noise	$V_O = 1\text{ V to }3\text{ V}$, $A_{VD} = 2$, $R_L = 2\text{ k}\Omega^\dagger$, $f = 10\text{ kHz}$	0.0052%	0.0052%				
B_1	Unity-gain bandwidth	$R_L = 2\text{ k}\Omega^\dagger$, $C_L = 100\text{ pF}^\dagger$	5.9	5.9		MHz		
	Gain-bandwidth product	$R_L = 2\text{ k}\Omega^\dagger$, $f = 100\text{ kHz}$	5.8	5.8		MHz		
B_{OM}	Maximum output-swing bandwidth	$V_{O(PP)} = 2\text{ V}$, $A_{VD} = 1$, $R_L = 2\text{ k}\Omega^\dagger$, $C_L = 100\text{ pF}^\dagger$	660	660		kHz		
ϕ_m	Phase margin at unity gain	$R_L = 2\text{ k}\Omega^\dagger$, $C_L = 100\text{ pF}^\dagger$	57°	57°				

$^\dagger R_L$ and C_L terminated to 2.5 V.

TLE214x, TLE214xA EXCALIBUR LOW-NOISE HIGH-SPEED PRECISION OPERATIONAL AMPLIFIERS

SLOS183C – FEBRUARY 1997 – REVISED JUNE 2006

TLE2141C electrical characteristics at specified free-air temperature, $V_{CC\pm} = \pm 15$ V (unless otherwise noted)

PARAMETER	TEST CONDITIONS	T_A †	TLE2141C			TLE2141AC			UNIT
			MIN	TYP	MAX	MIN	TYP	MAX	
V_{IO} Input offset voltage	$V_{IC} = 0,$ $V_O = 0$ $R_S = 50 \Omega,$	25°C	200	900		175	500	μV	
		Full range			1300		800		
α_{VIO} Temperature coefficient of input offset voltage		Full range	1.7			1.7		$\mu V/^\circ C$	
I_{IO} Input offset current		25°C	7	100		7	100	nA	
		Full range			150		150		
I_{IB} Input bias current		25°C	-0.7	-1.5		-0.7	-1.5	μA	
	Full range			-1.6		-1.6			
V_{ICR} Common-mode input voltage range	$R_S = 50 \Omega$	25°C	-15 to 13	-15.3 to 13.2		-15 to 13	-15.3 to 13.2	V	
		Full range	-15 to 12.9	-15.3 to 13.1		-15 to 12.9	-15.3 to 13.1		
V_{OM+} Maximum positive peak output voltage swing	$I_O = -150 \mu A$	25°C	13.8	14.1		13.8	14.1	V	
		Full range	13.7			13.7			
	$I_O = -1.5$ mA	25°C	13.7	14		13.7	14		
		Full range	13.6			13.6			
	$I_O = -15$ mA	25°C	13.1	13.7		13.1	13.7		
		Full range	13			13			
V_{OM-} Maximum negative peak output voltage swing	$I_O = 150 \mu A$	25°C	-14.7	-14.9		-14.7	-14.9	V	
		Full range	-14.6			-14.6			
	$I_O = 1.5$ mA	25°C	-14.5	-14.8		-14.5	-14.8		
		Full range	-14.4			-14.4			
	$I_O = 15$ mA	25°C	-13.4	-13.8		-13.4	-13.8		
		Full range	-13.3			-13.3			
A_{VD} Large-signal differential voltage amplification	$V_O = \pm 10$ V	25°C	100	450		100	450	V/mV	
		Full range	75			75			
r_i Input resistance	$R_L = 2$ k Ω	25°C	65			65	M Ω		
c_i Input capacitance		25°C	2.5			2.5	pF		
z_o Open-loop output impedance	$f = 1$ MHz	25°C	30			30	Ω		
CMRR Common-mode rejection ratio	$V_{IC} = V_{ICRmin},$ $R_S = 50 \Omega$	25°C	85	108		85	108	dB	
		Full range	80			80			
k_{SVR} Supply-voltage rejection ratio ($\Delta V_{CC\pm} / \Delta V_{IO}$)	$V_{CC\pm} = \pm 2.5$ V to ± 15 V, $R_S = 50 \Omega$	25°C	90	106		90	106	dB	
		Full range	85			85			
I_{OS} Short-circuit output current	$V_O = 0$	25°C	$V_{ID} = 1$ V	-25	-50		-25	-50	mA
			$V_{ID} = -1$ V	20	31		20	31	
I_{CC} Supply current	$V_O = 0,$ No load	25°C	3.5	4.5		3.5	4.5	mA	
		Full range			4.7		4.7		

† Full range is 0°C to 70°C.



TLE214x, TLE214xA
EXCALIBUR LOW-NOISE HIGH-SPEED
PRECISION OPERATIONAL AMPLIFIERS

SLOS183C – FEBRUARY 1997 – REVISED JUNE 2006

TLE2141C operating characteristics, $V_{CC\pm} = \pm 15\text{ V}$, $T_A = 25^\circ\text{C}$

PARAMETER	TEST CONDITIONS	TLE2141C			TLE2141AC			UNIT		
		MIN	TYP	MAX	MIN	TYP	MAX			
SR+	Positive slew rate	$A_{VD} = -1$, $C_L = 500\text{ pF}$		$R_L = 2\text{ k}\Omega$		27	45	27	45	V/ μs
SR-	Negative slew rate					27	42	27	42	
t_s	Settling time	$A_{VD} = -1$, 10-V step		To 0.1%	0.34		0.34		μs	
				To 0.01%	0.4		0.4			
V_n	Equivalent input noise voltage	$R_S = 20\ \Omega$, $f = 10\text{ Hz}$		15		15		nV/ $\sqrt{\text{Hz}}$		
		$R_S = 20\ \Omega$, $f = 1\text{ kHz}$		10.5		10.5				
$V_{N(PP)}$	Peak-to-peak equivalent input noise voltage	$f = 0.1\text{ Hz to }1\text{ Hz}$		0.48		0.48		μV		
		$f = 0.1\text{ Hz to }10\text{ Hz}$		0.51		0.51				
I_n	Equivalent input noise current	$f = 10\text{ Hz}$		1.89		1.89		pA/ $\sqrt{\text{Hz}}$		
		$f = 1\text{ kHz}$		0.47		0.47				
THD + N	Total harmonic distortion plus noise	$V_{O(PP)} = 20\text{ V}$, $A_{VD} = 10$		$R_L = 2\text{ k}\Omega$, $f = 10\text{ kHz}$		0.01%		0.01%		
B_1	Unity-gain bandwidth	$R_L = 2\text{ k}\Omega$, $C_L = 100\text{ pF}$		6		6		MHz		
	Gain-bandwidth product	$R_L = 2\text{ k}\Omega$, $f = 100\text{ kHz}$		5.9		5.9		MHz		
B_{OM}	Maximum output-swing bandwidth	$V_{O(PP)} = 20\text{ V}$, $A_{VD} = 1$		$R_L = 2\text{ k}\Omega$, $C_L = 100\text{ pF}$		668		668	kHz	
ϕ_m	Phase margin at unity gain	$R_L = 2\text{ k}\Omega$, $C_L = 100\text{ pF}$		58°		58°				

TLE214x, TLE214xA EXCALIBUR LOW-NOISE HIGH-SPEED PRECISION OPERATIONAL AMPLIFIERS

SLOS183C – FEBRUARY 1997 – REVISED JUNE 2006

TLE2142C electrical characteristics at specified free-air temperature, $V_{CC} = 5\text{ V}$ (unless otherwise noted)

PARAMETER	TEST CONDITIONS	T_A †	TLE2142C			TLE2142AC			UNIT
			MIN	TYP	MAX	MIN	TYP	MAX	
V_{IO} Input offset voltage	$V_O = 2.5\text{ V}$, $V_{IC} = 2.5\text{ V}$ $R_S = 50\ \Omega$	25°C	220	1900		200	1500	μV	
		Full range			2200		1800		
α_{VIO} Temperature coefficient of input offset voltage		Full range	1.7			1.7		$\mu\text{V}/^\circ\text{C}$	
I_{IO} Input offset current		25°C	8	100		8	100	nA	
		Full range			150		150		
I_{IB} Input bias current		25°C	-0.8	-2		-0.8	-2	μA	
	Full range			-2.1		-2.1			
V_{ICR} Common-mode input voltage range	$R_S = 50\ \Omega$	25°C	0 to 3	-0.3 to 3.2		0 to 3	-0.3 to 3.2	V	
		Full range	0 to 2.9			0 to 2.9			
V_{OH} High-level output voltage	$I_{OH} = -150\ \mu\text{A}$	25°C	3.9	4.1		3.9	4.1	V	
		Full range	3.8			3.8			
	$I_{OH} = -1.5\text{ mA}$	25°C	3.8	4		3.8	4		
		Full range	3.7			3.7			
	$I_{OH} = -15\text{ mA}$	25°C	3.4	3.7		3.4	3.7		
		Full range	3.4			3.4			
V_{OL} Low-level output voltage	$I_{OL} = 150\ \mu\text{A}$	25°C		75	125		75	125	mV
		Full range			150			150	
	$I_{OL} = 1.5\text{ mA}$	25°C		150	225		150	225	
		Full range			250			250	
	$I_{OL} = 15\text{ mA}$	25°C		1.2	1.4		1.2	1.4	V
		Full range			1.5			1.5	
A_{VD} Large-signal differential voltage amplification	$V_{CC} = \pm 2.5\text{ V}$, $R_L = 2\text{ k}\Omega$, $V_O = 1\text{ V to } -1.5\text{ V}$	25°C	50	220		50	220	V/mV	
		Full range	25			25			
r_i Input resistance		25°C	70			70	$\text{M}\Omega$		
c_i Input capacitance		25°C	2.5			2.5	pF		
z_o Open-loop output impedance	$f = 1\text{ MHz}$	25°C	30			30	Ω		
CMRR Common-mode rejection ratio	$V_{IC} = V_{ICRmin}$, $R_S = 50\ \Omega$	25°C	85	118		85	118	dB	
		Full range	80			80			
k_{SVR} Supply-voltage rejection ratio ($\Delta V_{CC\pm} / \Delta V_{IO}$)	$V_{CC\pm} = \pm 2.5\text{ V to } \pm 15\text{ V}$, $R_S = 50\ \Omega$	25°C	90	106		90	106	dB	
		Full range	85			85			
I_{CC} Supply current	$V_O = 2.5\text{ V}$, No load, $V_{IC} = 2.5\text{ V}$	25°C	6.6	8.8		6.6	8.8	mA	
		Full range			9.2		9.2		

† Full range is 0°C to 70°C.



TLE214x, TLE214xA
EXCALIBUR LOW-NOISE HIGH-SPEED
PRECISION OPERATIONAL AMPLIFIERS

SLOS183C – FEBRUARY 1997 – REVISED JUNE 2006

TLE2142C operating characteristics, $V_{CC} = 5\text{ V}$, $T_A = 25^\circ\text{C}$

PARAMETER		TEST CONDITIONS		TLE2142C			TLE2142AC			UNIT
				MIN	TYP	MAX	MIN	TYP	MAX	
SR+	Positive slew rate	$A_{VD} = -1$, $C_L = 500\text{ pF}$, $R_L = 2\text{ k}\Omega^\dagger$		45			45			V/ μs
SR-	Negative slew rate			42			42			
t_s	Settling time	$A_{VD} = -1$, 2.5-V step		To 0.1%			0.16			μs
				To 0.01%			0.22			
V_n	Equivalent input noise voltage	$R_S = 20\ \Omega$, $f = 10\text{ Hz}$		15			15			nV/ $\sqrt{\text{Hz}}$
		$R_S = 20\ \Omega$, $f = 1\text{ kHz}$		10.5			10.5			
$V_{N(PP)}$	Peak-to-peak equivalent input noise voltage	$f = 0.1\text{ Hz to }1\text{ Hz}$		0.48			0.48			μV
		$f = 0.1\text{ Hz to }10\text{ Hz}$		0.51			0.51			
I_n	Equivalent input noise current	$f = 10\text{ Hz}$		1.92			1.92			pA/ $\sqrt{\text{Hz}}$
		$f = 1\text{ kHz}$		0.5			0.5			
THD + N	Total harmonic distortion plus noise	$V_O = 1\text{ V to }3\text{ V}$, $A_{VD} = 2$, $R_L = 2\text{ k}\Omega^\dagger$, $f = 10\text{ kHz}$		0.0052%			0.0052%			
B1	Unity-gain bandwidth	$R_L = 2\text{ k}\Omega^\dagger$, $C_L = 100\text{ pF}$		5.9			5.9			MHz
	Gain-bandwidth product	$R_L = 2\text{ k}\Omega^\dagger$, $f = 100\text{ kHz}$		5.8			5.8			MHz
B_{OM}	Maximum output-swing bandwidth	$V_{O(PP)} = 2\text{ V}$, $A_{VD} = 1$, $R_L = 2\text{ k}\Omega^\dagger$, $C_L = 100\text{ pF}$		660			660			kHz
ϕ_m	Phase margin at unity gain	$R_L = 2\text{ k}\Omega^\dagger$, $C_L = 100\text{ pF}$		57°			57°			

$^\dagger R_L$ terminates at 2.5 V.

TLE214x, TLE214xA EXCALIBUR LOW-NOISE HIGH-SPEED PRECISION OPERATIONAL AMPLIFIERS

SLOS183C – FEBRUARY 1997 – REVISED JUNE 2006

TLE2142C electrical characteristics at specified free-air temperature, $V_{CC\pm} = \pm 15$ V (unless otherwise noted)

PARAMETER	TEST CONDITIONS	T_A †	TLE2142C			TLE2142AC			UNIT
			MIN	TYP	MAX	MIN	TYP	MAX	
V_{IO} Input offset voltage	$V_{IC} = 0,$ $V_O = 0$ $R_S = 50 \Omega,$	25°C	290	1200		275	750	μV	
		Full range			1600		1200		
α_{VIO} Temperature coefficient of input offset voltage		Full range	1.7			1.7		$\mu V/^\circ C$	
I_{IO} Input offset current		25°C	7	100		7	100	nA	
		Full range			150		150		
I_{IB} Input bias current		25°C	-0.7	-1.5		-0.7	-1.5	μA	
	Full range			-1.6		-1.6			
V_{ICR} Common-mode input voltage range	$R_S = 50 \Omega$	25°C	-15 to 13	-15.3 to 13.2		-15 to 13	-15.3 to 13.2	V	
		Full range	-15 to 12.9	-15.3 to 13.1		-15 to 12.9	-15.3 to 13.1		
V_{OM+} Maximum positive peak output voltage swing	$I_O = -150 \mu A$	25°C	13.8	14.1		13.8	14.1	V	
		Full range	13.7			13.7			
	$I_O = -1.5$ mA	25°C	13.7	14		13.7	14		
		Full range	13.6			13.6			
	$I_O = -15$ mA	25°C	13.3	13.7		13.3	13.7		
		Full range	13.2			13.2			
V_{OM-} Maximum negative peak output voltage swing	$I_O = 150 \mu A$	25°C	-14.7	-14.9		-14.7	-14.9	V	
		Full range	-14.6			-14.6			
	$I_O = 1.5$ mA	25°C	-14.5	-14.8		-14.5	-14.8		
		Full range	-14.4			-14.4			
	$I_O = 15$ mA	25°C	-13.4	-13.8		-13.4	-13.8		
		Full range	-13.3			-13.3			
A_{VD} Large-signal differential voltage amplification	$V_O = \pm 10$ V	25°C	100	450		100	450	V/mV	
		Full range	75			75			
r_i Input resistance	$R_L = 2$ k Ω	25°C	65			65	M Ω		
c_i Input capacitance		25°C	2.5			2.5	pF		
z_o Open-loop output impedance	$f = 1$ MHz	25°C	30			30	Ω		
CMRR Common-mode rejection ratio	$V_{IC} = V_{ICRmin},$ $R_S = 50 \Omega$	25°C	85	108		85	108	dB	
		Full range	80			80			
k_{SVR} Supply-voltage rejection ratio ($\Delta V_{CC\pm} / \Delta V_{IO}$)	$V_{CC\pm} = \pm 2.5$ V to ± 15 V, $R_S = 50 \Omega$	25°C	90	106		90	106	dB	
		Full range	85			85			
I_{OS} Short-circuit output current	$V_O = 0$	25°C	$V_{ID} = 1$ V	-25	-50		-25	-50	mA
			$V_{ID} = -1$ V	20	31		20	31	
I_{CC} Supply current	$V_O = 0,$ No load	25°C	6.9	9		6.9	9	mA	
		Full range			9.4		9.4		

† Full range is 0°C to 70°C.



TLE214x, TLE214xA
EXCALIBUR LOW-NOISE HIGH-SPEED
PRECISION OPERATIONAL AMPLIFIERS

SLOS183C – FEBRUARY 1997 – REVISED JUNE 2006

TLE2142C operating characteristics, $V_{CC\pm} = \pm 15\text{ V}$, $T_A = 25^\circ\text{C}$

PARAMETER	TEST CONDITIONS	TLE2142C			TLE2142AC			UNIT		
		MIN	TYP	MAX	MIN	TYP	MAX			
SR+	Positive slew rate	$A_{VD} = -1$, $C_L = 500\text{ pF}$		$R_L = 2\text{ k}\Omega$		27	45	27	45	V/ μs
SR-	Negative slew rate					27	42	27	42	
t_s	Settling time	$A_{VD} = -1$, 10-V step	To 0.1%	0.34		0.34		μs		
			To 0.01%	0.4		0.4				
V_n	Equivalent input noise voltage	$R_S = 20\ \Omega$,	$f = 10\text{ Hz}$	15		15		nV/ $\sqrt{\text{Hz}}$		
		$R_S = 20\ \Omega$,	$f = 1\text{ kHz}$	10.5		10.5				
$V_{N(PP)}$	Peak-to-peak equivalent input noise voltage	$f = 0.1\text{ Hz to }1\text{ Hz}$		0.48		0.48		μV		
		$f = 0.1\text{ Hz to }10\text{ Hz}$		0.51		0.51				
I_n	Equivalent input noise current	$f = 10\text{ Hz}$		1.89		1.89		pA/ $\sqrt{\text{Hz}}$		
		$f = 1\text{ kHz}$		0.47		0.47				
THD + N	Total harmonic distortion plus noise	$V_{O(PP)} = 20\text{ V}$, $A_{VD} = 10$,	$R_L = 2\text{ k}\Omega$, $f = 10\text{ kHz}$	0.01%		0.01%				
B_1	Unity-gain bandwidth	$R_L = 2\text{ k}\Omega$,	$C_L = 100\text{ pF}$	6		6		MHz		
	Gain-bandwidth product	$R_L = 2\text{ k}\Omega$, $f = 100\text{ kHz}$	$C_L = 100\text{ pF}$,	5.9		5.9		MHz		
B_{OM}	Maximum output-swing bandwidth	$V_{O(PP)} = 20\text{ V}$, $A_{VD} = 1$,	$R_L = 2\text{ k}\Omega$, $C_L = 100\text{ pF}$	668		668		kHz		
ϕ_m	Phase margin at unity gain	$R_L = 2\text{ k}\Omega$,	$C_L = 100\text{ pF}$	58°		58°				

TLE214x, TLE214xA EXCALIBUR LOW-NOISE HIGH-SPEED PRECISION OPERATIONAL AMPLIFIERS

SLOS183C – FEBRUARY 1997 – REVISED JUNE 2006

TLE2144C electrical characteristics at specified free-air temperature, $V_{CC} = 5\text{ V}$ (unless otherwise noted)

PARAMETER	TEST CONDITIONS	T_A †	TLE2144C			TLE2144AC			UNIT
			MIN	TYP	MAX	MIN	TYP	MAX	
V_{IO} Input offset voltage	$V_O = 2.5\text{ V}$, $V_{IC} = 2.5\text{ V}$ $R_S = 50\ \Omega$	25°C	0.5	3.8		0.5	3	mV	
		Full range			4.4		3.6		
α_{VIO} Temperature coefficient of input offset voltage		Full range		1.7			1.7	$\mu\text{V}/^\circ\text{C}$	
I_{IO} Input offset current		25°C	8	100		8	100	nA	
		Full range			150		150		
I_{IB} Input bias current		25°C	-0.8	-2		-0.8	-2	μA	
	Full range			-2.1		-2.1			
V_{ICR} Common-mode input voltage range	$R_S = 50\ \Omega$	25°C	0 to 3	-0.3 to 3.2		0 to 3	-0.3 to 3.2	V	
		Full range	0 to 2.9			0 to 2.9			
V_{OH} High-level output voltage	$I_{OH} = -150\ \mu\text{A}$	25°C	3.9	4.1		3.9	4.1	V	
		Full range	3.8			3.8			
	$I_{OH} = -1.5\text{ mA}$	25°C	3.8	4		3.8	4		
		Full range	3.7			3.7			
	$I_{OH} = -15\text{ mA}$	25°C	3.4	3.7		3.4	3.7		
		Full range	3.4			3.4			
V_{OL} Low-level output voltage	$I_{OL} = 150\ \mu\text{A}$	25°C		75	125		75	125	mV
		Full range			150			150	
	$I_{OL} = 1.5\text{ mA}$	25°C		150	225		150	225	
		Full range			250			250	
	$I_{OL} = 15\text{ mA}$	25°C		1.2	1.6		1.2	1.6	V
		Full range			1.7			1.7	
A_{VD} Large-signal differential voltage amplification	$V_{CC} = \pm 2.5\text{ V}$, $V_O = 1\text{ V to } -1.5\text{ V}$ $R_L = 2\text{ k}\Omega$	25°C	50	95		50	95	V/mV	
		Full range	25			25			
r_i Input resistance		25°C		70			70	$\text{M}\Omega$	
c_i Input capacitance		25°C		2.5			2.5	pF	
z_o Open-loop output impedance	$f = 1\text{ MHz}$	25°C		30			30	Ω	
CMRR Common-mode rejection ratio	$V_{IC} = V_{ICRmin}$, $R_S = 50\ \Omega$	25°C	85	118		85	118	dB	
		Full range	80			80			
k_{SVR} Supply-voltage rejection ratio ($\Delta V_{CC\pm} / \Delta V_{IO}$)	$V_{CC\pm} = \pm 2.5\text{ V to } \pm 15\text{ V}$, $R_S = 50\ \Omega$	25°C	90	106		90	106	dB	
		Full range	85			85			
I_{CC} Supply current	$V_O = 2.5\text{ V}$, $V_{IC} = 2.5\text{ V}$ No load,	25°C		13.2	17.6		13.2	17.6	mA
		Full range			18.5			18.5	

† Full range is 0°C to 70°C.



TLE214x, TLE214xA
EXCALIBUR LOW-NOISE HIGH-SPEED
PRECISION OPERATIONAL AMPLIFIERS

SLOS183C – FEBRUARY 1997 – REVISED JUNE 2006

TLE2144C operating characteristics, $V_{CC} = 5\text{ V}$, $T_A = 25^\circ\text{C}$

PARAMETER	TEST CONDITIONS	TLE2144C			TLE2144AC			UNIT
		MIN	TYP	MAX	MIN	TYP	MAX	
SR+	Positive slew rate	$A_{VD} = -1$, $C_L = 500\text{ pF}$		$R_L = 2\text{ k}\Omega^\dagger$		45		V/ μs
SR-	Negative slew rate					42		
t_s	Settling time	$A_{VD} = -1$, 2.5-V step	To 0.1%	0.16		0.16		μs
			To 0.01%	0.22		0.22		
V_n	Equivalent input noise voltage	$R_S = 20\ \Omega$, $f = 10\text{ Hz}$	15		15		nV/ $\sqrt{\text{Hz}}$	
		$R_S = 20\ \Omega$, $f = 1\text{ kHz}$	10.5		10.5			
$V_{N(PP)}$	Peak-to-peak equivalent input noise voltage	$f = 0.1\text{ Hz to }1\text{ Hz}$	0.48		0.48		μV	
		$f = 0.1\text{ Hz to }10\text{ Hz}$	0.51		0.51			
I_n	Equivalent input noise current	$f = 10\text{ Hz}$	1.92		1.92		pA/ $\sqrt{\text{Hz}}$	
		$f = 1\text{ kHz}$	0.5		0.5			
THD + N	Total harmonic distortion plus noise	$V_O = 1\text{ V to }3\text{ V}$, $A_{VD} = 2$,	$R_L = 2\text{ k}\Omega^\dagger$, $f = 10\text{ kHz}$	0.0052%		0.0052%		
B_1	Unity-gain bandwidth	$R_L = 2\text{ k}\Omega^\dagger$,	$C_L = 100\text{ pF}$	5.9		5.9		MHz
	Gain-bandwidth product	$R_L = 2\text{ k}\Omega^\dagger$, $f = 100\text{ kHz}$	$C_L = 100\text{ pF}$	5.8		5.8		MHz
B_{OM}	Maximum output-swing bandwidth	$V_{O(PP)} = 2\text{ V}$, $A_{VD} = 1$,	$R_L = 2\text{ k}\Omega^\dagger$, $C_L = 100\text{ pF}$	660		660		kHz
ϕ_m	Phase margin at unity gain	$R_L = 2\text{ k}\Omega^\dagger$,	$C_L = 100\text{ pF}$	57°		57°		

$\dagger R_L$ terminates at 2.5 V

TLE214x, TLE214xA EXCALIBUR LOW-NOISE HIGH-SPEED PRECISION OPERATIONAL AMPLIFIERS

SLOS183C – FEBRUARY 1997 – REVISED JUNE 2006

TLE2144C electrical characteristics at specified free-air temperature, $V_{CC\pm} = \pm 15$ V (unless otherwise noted)

PARAMETER	TEST CONDITIONS	T_A †	TLE2144C			TLE2144AC			UNIT
			MIN	TYP	MAX	MIN	TYP	MAX	
V_{IO} Input offset voltage	$V_{IC} = 0,$ $V_O = 0$ $R_S = 50 \Omega$	25°C	0.6	2.4		0.5	1.5	mV	
		Full range			3.2		2.4		
α_{VIO} Temperature coefficient of input offset voltage		Full range	1.7			1.7		$\mu\text{V}/^\circ\text{C}$	
I_{IO} Input offset current		25°C	7	100		7	100	nA	
		Full range			150		150		
I_{IB} Input bias current		25°C	-0.7	-1.5		-0.7	-1.5	μA	
	Full range			-1.6		-1.6			
V_{ICR} Common-mode input voltage range	$R_S = 50 \Omega$	25°C	-15 to 13	-15.3 to 13.2		-15 to 13	-15.3 to 13.2	V	
		Full range	-15 to 12.9	-15.3 to 13.1		-15 to 12.9	-15 to 13.1		
V_{OM+} Maximum positive peak output voltage swing	$I_O = -150 \mu\text{A}$	25°C	13.8	14.1		13.8	14.1	V	
		Full range			13.7		13.7		
	$I_O = -1.5 \text{ mA}$	25°C	13.7	14		13.7	14		
		Full range			13.6		13.6		
	$I_O = -15 \text{ mA}$	25°C	13.1	13.7		13.1	13.7		
		Full range			13		13		
V_{OM-} Maximum negative peak output voltage swing	$I_O = 150 \mu\text{A}$	25°C	-14.7	-14.9		-14.7	-14.9	V	
		Full range			-14.6		-14.6		
	$I_O = 1.5 \text{ mA}$	25°C	-14.5	-14.8		-14.5	-14.8		
		Full range			-14.4		-14.4		
	$I_O = 15 \text{ mA}$	25°C	-13.4	-13.8		-13.4	-13.8		
		Full range			-13.3		-13.3		
A_{VD} Large-signal differential voltage amplification	$V_O = \pm 10 \text{ V}$	25°C	100	170		100	170	V/mV	
		Full range			75		75		
r_i Input resistance	$R_L = 2 \text{ k}\Omega$	25°C		65		65	$\text{M}\Omega$		
c_i Input capacitance		25°C		2.5		2.5	pF		
z_o Open-loop output impedance	$f = 1 \text{ MHz}$	25°C		30		30	Ω		
CMRR Common-mode rejection ratio	$V_{IC} = V_{ICRmin}, R_S = 50 \Omega$	25°C	85	108		85	108	dB	
		Full range			80		80		
k_{SVR} Supply-voltage rejection ratio ($\Delta V_{CC\pm} / \Delta V_{IO}$)	$V_{CC\pm} = \pm 2.5 \text{ V to } \pm 15 \text{ V},$ $R_S = 50 \Omega$	25°C	90	106		90	106	dB	
		Full range			85		85		
I_{OS} Short-circuit output current	$V_O = 0$	25°C	$V_{ID} = 1 \text{ V}$	-25	-50		-25	-50	mA
			$V_{ID} = -1 \text{ V}$	20	31		20	31	
I_{CC} Supply current	$V_O = 0,$ No load	25°C		13.8	18		13.8	18	mA
		Full range			18.8		18.8		

† Full range is 0°C to 70°C.



TLE214x, TLE214xA
EXCALIBUR LOW-NOISE HIGH-SPEED
PRECISION OPERATIONAL AMPLIFIERS

SLOS183C – FEBRUARY 1997 – REVISED JUNE 2006

TLE2144C operating characteristics, $V_{CC\pm} = \pm 15\text{ V}$, $T_A = 25^\circ\text{C}$

PARAMETER		TEST CONDITIONS		TLE2144C			TLE2144AC			UNIT
				MIN	TYP	MAX	MIN	TYP	MAX	
SR+	Positive slew rate	$A_{VD} = -1$, $C_L = 500\text{ pF}$	$R_L = 2\text{ k}\Omega$	27	45		27	45		V/ μs
SR-	Negative slew rate			27	42		27	42		
t_s	Settling time	$A_{VD} = -1$, 10-V step	To 0.1%	0.34			0.34			μs
			To 0.01%	0.4			0.4			
V_n	Equivalent input noise voltage	$R_S = 20\ \Omega$	$f = 10\text{ Hz}$	15			15			nV/ $\sqrt{\text{Hz}}$
			$f = 1\text{ kHz}$	10.5			10.5			
$V_{N(PP)}$	Peak-to-peak equivalent input noise voltage	$f = 0.1\text{ Hz to }1\text{ Hz}$		0.48			0.48			μV
		$f = 0.1\text{ Hz to }10\text{ Hz}$		0.51			0.51			
I_n	Equivalent input noise current	$f = 10\text{ Hz}$		1.89			1.89			pA/ $\sqrt{\text{Hz}}$
		$f = 1\text{ kHz}$		0.47			0.47			
THD + N	Total harmonic distortion plus noise	$V_{O(PP)} = 20\text{ V}$, $A_{VD} = 10$	$R_L = 2\text{ k}\Omega$, $f = 10\text{ kHz}$	0.01%			0.01%			
B_1	Unity-gain bandwidth	$R_L = 2\text{ k}\Omega$	$C_L = 100\text{ pF}$	6			6			MHz
	Gain-bandwidth product	$R_L = 2\text{ k}\Omega$, $f = 100\text{ kHz}$	$C_L = 100\text{ pF}$	5.9			5.9			MHz
B_{OM}	Maximum output-swing bandwidth	$V_{O(PP)} = 20\text{ V}$, $A_{VD} = 1$	$R_L = 2\text{ k}\Omega$, $C_L = 100\text{ pF}$	668			668			kHz
ϕ_m	Phase margin at unity gain	$R_L = 2\text{ k}\Omega$	$C_L = 100\text{ pF}$	58°			58°			

TLE214x, TLE214xA EXCALIBUR LOW-NOISE HIGH-SPEED PRECISION OPERATIONAL AMPLIFIERS

SLOS183C – FEBRUARY 1997 – REVISED JUNE 2006

TLE2141I electrical characteristics at specified free-air temperature, $V_{CC} = 5\text{ V}$ (unless otherwise noted)

PARAMETER	TEST CONDITIONS	T_A †	TLE2141I			TLE2141AI			UNIT
			MIN	TYP	MAX	MIN	TYP	MAX	
V_{IO} Input offset voltage	$V_O = 2.5\text{ V}$, $V_{IC} = 2.5\text{ V}$ $R_S = 50\ \Omega$	25°C	225	1400		200	1000	μV	
		Full range			1900		1500		
α_{VIO} Temperature coefficient of input offset voltage		Full range	1.7			1.7		$\mu\text{V}/^\circ\text{C}$	
I_{IO} Input offset current		25°C	8	100		8	100	nA	
		Full range			200		200		
I_{IB} Input bias current		25°C	-0.8	-2		-0.8	-2	μA	
	Full range			-2.2		-2.2			
V_{ICR} Common-mode input voltage range	$R_S = 50\ \Omega$	25°C	0 to 3	-0.3 to 3.2		0 to 3	-0.3 to 3.2	V	
		Full range	0 to 2.7	-0.3 to 2.9		0 to 2.7	-0.3 to 2.9		
V_{OH} High-level output voltage	$I_{OH} = -150\ \mu\text{A}$	25°C	3.9	4.1		3.9	4.1	V	
	$I_{OH} = -1.5\text{ mA}$		3.8	4		3.8	4		
	$I_{OH} = -15\text{ mA}$	Full range	3.2	3.7		3.2	3.7		
	$I_{OH} = -100\ \mu\text{A}$		3.8			3.8			
	$I_{OH} = -1\text{ mA}$		3.7			3.7			
	$I_{OH} = -10\text{ mA}$		3.3			3.3			
V_{OL} Low-level output voltage	$I_{OL} = 150\ \mu\text{A}$	25°C	75	125		75	125	mV	
	$I_{OL} = 1.5\ \mu\text{A}$		150	225		150	225		
	$I_{OL} = 15\text{ mA}$		1.2	1.6		1.2	1.6		
	$I_{OL} = 100\ \mu\text{A}$	Full range			175		175	mV	
	$I_{OL} = 1\text{ mA}$				225		225		
	$I_{OL} = 10\text{ mA}$				1.4		1.4		
A_{VD} Large-signal differential voltage amplification	$V_{CC} = \pm 2.5\text{ V}$, $R_L = 2\text{ k}\Omega$, $V_O = 1\text{ V to } -1.5\text{ V}$	25°C	50	220		50	220	V/mV	
		Full range	10			10			
r_i Input resistance		25°C	70			70	$\text{M}\Omega$		
c_i Input capacitance		25°C	2.5			2.5	pF		
z_o Open-loop output impedance	$f = 1\text{ MHz}$	25°C	30			30	Ω		
CMRR Common-mode rejection ratio	$V_{IC} = V_{ICRmin}$, $R_S = 50\ \Omega$	25°C	85	118		85	118	dB	
		Full range	80			80			
k_{SVR} Supply-voltage rejection ratio ($\Delta V_{CC\pm} / \Delta V_{IO}$)	$V_{CC\pm} = \pm 2.5\text{ V to } \pm 15\text{ V}$, $R_S = 50\ \Omega$	25°C	90	106		90	106	dB	
		Full range	85			85			
I_{CC} Supply current	$V_O = 2.5\text{ V}$, $V_{IC} = 2.5\text{ V}$ No load,	25°C	3.4	4.4		3.4	4.4	mA	
		Full range			4.6		4.6		

† Full range is -40°C to 105°C .



TLE214x, TLE214xA
EXCALIBUR LOW-NOISE HIGH-SPEED
PRECISION OPERATIONAL AMPLIFIERS

SLOS183C – FEBRUARY 1997 – REVISED JUNE 2006

TLE2141I operating characteristics, $V_{CC} = 5\text{ V}$, $T_A = 25^\circ\text{C}$

PARAMETER	TEST CONDITIONS	TLE2141I			TLE2141AI			UNIT
		MIN	TYP	MAX	MIN	TYP	MAX	
SR+	Positive slew rate	$A_{VD} = -1$, $C_L = 500\text{ pF}$		$R_L = 2\text{ k}\Omega^\dagger$		45		V/ μs
SR-	Negative slew rate					42		
t_s	Settling time	$A_{VD} = -1$, 2.5-V step		To 0.1%		0.16		μs
				To 0.01%		0.22		
V_n	Equivalent input noise voltage	$R_S = 20\ \Omega$, $f = 10\text{ Hz}$		15		15		nV/ $\sqrt{\text{Hz}}$
		$R_S = 20\ \Omega$, $f = 1\text{ kHz}$		10.5		10.5		
$V_{N(PP)}$	Peak-to-peak equivalent input noise voltage	$f = 0.1\text{ Hz to }1\text{ Hz}$		0.48		0.48		μV
		$f = 0.1\text{ Hz to }10\text{ Hz}$		0.51		0.51		
I_n	Equivalent input noise current	$f = 10\text{ Hz}$		1.92		1.92		pA/ $\sqrt{\text{Hz}}$
		$f = 1\text{ kHz}$		0.5		0.5		
THD + N	Total harmonic distortion plus noise	$V_O = 1\text{ V to }3\text{ V}$, $A_{VD} = 2$		$R_L = 2\text{ k}\Omega^\dagger$, $f = 10\text{ kHz}$		0.0052%		
B_1	Unity-gain bandwidth	$R_L = 2\text{ k}\Omega^\dagger$		$C_L = 100\text{ pF}^\dagger$		5.9		MHz
	Gain-bandwidth product	$R_L = 2\text{ k}\Omega^\dagger$, $f = 100\text{ kHz}$		$C_L = 100\text{ pF}^\dagger$		5.8		MHz
B_{OM}	Maximum output-swing bandwidth	$V_{O(PP)} = 2\text{ V}$, $A_{VD} = 1$		$R_L = 2\text{ k}\Omega^\dagger$, $C_L = 100\text{ pF}^\dagger$		660		kHz
ϕ_m	Phase margin at unity gain	$R_L = 2\text{ k}\Omega^\dagger$		$C_L = 100\text{ pF}^\dagger$		57°		

$^\dagger R_L$ and C_L terminated to 2.5 V.

TLE214x, TLE214xA EXCALIBUR LOW-NOISE HIGH-SPEED PRECISION OPERATIONAL AMPLIFIERS

SLOS183C – FEBRUARY 1997 – REVISED JUNE 2006

TLE2141I electrical characteristics at specified free-air temperature, $V_{CC\pm} = \pm 15\text{ V}$ (unless otherwise noted)

PARAMETER	TEST CONDITIONS	T_A †	TLE2141I			TLE2141AI			UNIT
			MIN	TYP	MAX	MIN	TYP	MAX	
V_{IO} Input offset voltage	$V_{IC} = 0, R_S = 50\ \Omega, V_O = 0$	25°C	200	900		175	500	μV	
		Full range			1500		1000		
α_{VIO} Temperature coefficient of input offset voltage		Full range	1.7			1.7		$\mu\text{V}/^\circ\text{C}$	
I_{IO} Input offset current		25°C	7	100		7	100	nA	
		Full range			200		200		
I_{IB} Input bias current		25°C	-0.7	-1.5		-0.7	-1.5	μA	
	Full range			-1.7		-1.7			
V_{ICR} Common-mode input voltage range	$R_S = 50\ \Omega$	25°C	-15 to 13	-15.3 to 13.2		-15 to 13	-15.3 to 13.2	V	
		Full range	-15 to 12.7	-15.3 to 12.9		-15 to 12.7	-15.3 to 12.9		
V_{OM+} Maximum positive peak output voltage swing	$I_O = -150\ \mu\text{A}$ $I_O = -1.5\ \text{mA}$ $I_O = -15\ \text{mA}$ $I_O = -100\ \mu\text{A}$ $I_O = -1\ \text{mA}$ $I_O = -10\ \text{mA}$	25°C	13.8	14.1		13.8	14.1	V	
			13.7	14		13.7	14		
			13.1	13.7		13.1	13.7		
		Full range	13.7			13.7			
			13.6			13.6			
			13.1			13.1			
V_{OM-} Maximum negative peak output voltage swing	$I_O = 150\ \mu\text{A}$ $I_O = 1.5\ \text{mA}$ $I_O = 15\ \text{mA}$ $I_O = 100\ \mu\text{A}$ $I_O = 1\ \text{mA}$ $I_O = 10\ \text{mA}$	25°C	-14.7	-14.9		-14.7	-14.9	V	
			-14.5	-14.8		-14.5	-14.8		
			-13.4	-13.8		-13.4	-13.8		
		Full range	-14.6			-14.6			
			-14.5			-14.5			
			-13.4			-13.4			
A_{VD} Large-signal differential voltage amplification	$V_O = \pm 10\ \text{V}, R_L = 2\ \text{k}\Omega$	25°C	100	450		100	450	V/mV	
		Full range	40			40			
r_i Input resistance		25°C	65			65	$\text{M}\Omega$		
c_i Input capacitance		25°C	2.5			2.5	pF		
z_o Open-loop output impedance	$f = 1\ \text{MHz}$	25°C	30			30	Ω		
CMRR Common-mode rejection ratio	$V_{IC} = V_{ICRmin}, R_S = 50\ \Omega$	25°C	85	108		85	108	dB	
		Full range	80			80			
k_{SVR} Supply-voltage rejection ratio ($\Delta V_{CC\pm} / \Delta V_{IO}$)	$V_{CC\pm} = \pm 2.5\ \text{V to } \pm 15\ \text{V}, R_S = 50\ \Omega$	25°C	90	106		90	106	dB	
		Full range	85			85			
I_{OS} Short-circuit output current	$V_O = 0$	25°C	$V_{ID} = 1\ \text{V}$	-25	-50		-25	-50	mA
			$V_{ID} = -1\ \text{V}$	20	31		20	31	
I_{CC} Supply current	$V_O = 0, \text{ No load}$	25°C	3.5	4.5		3.5	4.5	mA	
		Full range			4.7		4.7		

† Full range is -40°C to 105°C .



TLE214x, TLE214xA
EXCALIBUR LOW-NOISE HIGH-SPEED
PRECISION OPERATIONAL AMPLIFIERS

SLOS183C – FEBRUARY 1997 – REVISED JUNE 2006

TLE2141I operating characteristics, $V_{CC\pm} = \pm 15\text{ V}$, $T_A = 25^\circ\text{C}$

PARAMETER		TEST CONDITIONS		TLE2141I			TLE2141AI			UNIT
				MIN	TYP	MAX	MIN	TYP	MAX	
SR+	Positive slew rate	$A_{VD} = -1$, $C_L = 500\text{ pF}$	$R_L = 2\text{ k}\Omega$	27	45		27	45	V/ μs	
SR-	Negative slew rate			27	42		27	42		
t_s	Settling time	$A_{VD} = -1$, 10-V step	To 0.1%	0.34			0.34			μs
			To 0.01%	0.4			0.4			
V_n	Equivalent input noise voltage	$R_S = 20\ \Omega$	$f = 10\text{ Hz}$	15			15			nV/ $\sqrt{\text{Hz}}$
			$f = 1\text{ kHz}$	10.5			10.5			
$V_{N(PP)}$	Peak-to-peak equivalent input noise voltage	$f = 0.1\text{ Hz to }1\text{ Hz}$		0.48			0.48			μV
		$f = 0.1\text{ Hz to }10\text{ Hz}$		0.51			0.51			
I_n	Equivalent input noise current	$f = 10\text{ Hz}$		1.89			1.89			pA/ $\sqrt{\text{Hz}}$
		$f = 1\text{ kHz}$		0.47			0.47			
THD + N	Total harmonic distortion plus noise	$V_{O(PP)} = 20\text{ V}$, $A_{VD} = 10$,	$R_L = 2\text{ k}\Omega$, $f = 10\text{ kHz}$	0.01%			0.01%			
B_1	Unity-gain bandwidth	$R_L = 2\text{ k}\Omega$,	$C_L = 100\text{ pF}$	6			6			MHz
	Gain-bandwidth product	$R_L = 2\text{ k}\Omega$, $f = 100\text{ kHz}$	$C_L = 100\text{ pF}$	5.9			5.9			MHz
B_{OM}	Maximum output-swing bandwidth	$V_{O(PP)} = 20\text{ V}$, $A_{VD} = 1$,	$R_L = 2\text{ k}\Omega$, $C_L = 100\text{ pF}$	668			668			kHz
ϕ_m	Phase margin at unity gain	$R_L = 2\text{ k}\Omega$,	$C_L = 100\text{ pF}$	58°			58°			

TLE214x, TLE214xA EXCALIBUR LOW-NOISE HIGH-SPEED PRECISION OPERATIONAL AMPLIFIERS

SLOS183C – FEBRUARY 1997 – REVISED JUNE 2006

TLE2142I electrical characteristics at specified free-air temperature, $V_{CC} = 5\text{ V}$ (unless otherwise noted)

PARAMETER	TEST CONDITIONS	T_A †	TLE2142I			TLE2142AI			UNIT
			MIN	TYP	MAX	MIN	TYP	MAX	
V_{IO} Input offset voltage	$V_O = 2.5\text{ V}$, $V_{IC} = 2.5\text{ V}$ $R_S = 50\ \Omega$	25°C	220	1900		220	1500	μV	
		Full range			2400		2000		
α_{VIO} Temperature coefficient of input offset voltage		Full range	1.7			1.7		$\mu\text{V}/^\circ\text{C}$	
I_{IO} Input offset current		25°C	8	100		8	100	nA	
		Full range			200		200		
I_{IB} Input bias current		25°C	-0.8	-2		-0.8	-2	μA	
	Full range			-2.2		-2.2			
V_{ICR} Common-mode input voltage range	$R_S = 50\ \Omega$	25°C	0 to 3	-0.3 to 3.2		0 to 3	-0.3 to 3.2	V	
		Full range	0 to 2.7	-0.3 to 2.9		0 to 2.7	-0.3 to 2.9		
V_{OH} High-level output voltage	$I_{OH} = -150\ \mu\text{A}$	25°C	3.9	4.1		3.9	4.1	V	
	$I_{OH} = -1.5\text{ mA}$		3.8	4		3.8	4		
	$I_{OH} = -15\text{ mA}$		3.4	3.7		3.4	3.7		
	Full range	$I_{OH} = 100\ \mu\text{A}$	3.8			3.8			
		$I_{OH} = 1\text{ mA}$	3.7			3.7			
		$I_{OH} = 10\text{ mA}$	3.5			3.5			
V_{OL} Low-level output voltage	$I_{OL} = 150\ \mu\text{A}$	25°C	75	125		75	125	mV	
	$I_{OL} = 1.5\text{ mA}$		150	225		150	225		
	$I_{OL} = 15\text{ mA}$		1.2	1.4		1.2	1.4		
	Full range	$I_{OL} = 100\ \mu\text{A}$	175			175			
		$I_{OL} = 1\text{ mA}$	225			225			
		$I_{OL} = 10\text{ mA}$	1.2			1.2			
A_{VD} Large-signal differential voltage amplification	$V_{IC} = \pm 2.5\text{ V}$, $V_O = 1\text{ V to } -1.5\text{ V}$, $R_L = 2\text{ k}\Omega$	25°C	50	220		50	220	V/mV	
		Full range	10			10			
r_i Input resistance		25°C	70			70	$\text{M}\Omega$		
c_i Input capacitance		25°C	2.5			2.5	pF		
z_o Open-loop output impedance	$f = 1\text{ MHz}$	25°C	30			30	Ω		
CMRR Common-mode rejection ratio	$V_{IC} = V_{ICRmin}$, $R_S = 50\ \Omega$	25°C	85	118		85	118	dB	
		Full range	80			80			
k_{SVR} Supply-voltage rejection ratio ($\Delta V_{CC\pm} / \Delta V_{IO}$)	$V_{CC\pm} = \pm 2.5\text{ V to } \pm 15\text{ V}$, $R_S = 50\ \Omega$	25°C	90	106		90	106	dB	
		Full range	85			85			
I_{CC} Supply current	$V_O = 2.5\text{ V}$, $V_{IC} = 2.5\text{ V}$	No load,	25°C	6.6	8.8		6.6	8.8	mA
			Full range			9.2		9.2	

† Full range is -40°C to 105°C .



TLE214x, TLE214xA
EXCALIBUR LOW-NOISE HIGH-SPEED
PRECISION OPERATIONAL AMPLIFIERS

SLOS183C – FEBRUARY 1997 – REVISED JUNE 2006

TLE2142I operating characteristics, $V_{CC} = 5\text{ V}$, $T_A = 25^\circ\text{C}$

PARAMETER	TEST CONDITIONS	TLE2142I			TLE2142AI			UNIT
		MIN	TYP	MAX	MIN	TYP	MAX	
SR+	Positive slew rate	$A_{VD} = -1$, $R_L = 2\text{ k}\Omega^\dagger$, $C_L = 500\text{ pF}$			45			V/ μs
SR-	Negative slew rate				42			
t_s	Settling time	$A_{VD} = -1$, 2.5-V step	To 0.1%	0.16			μs	
			To 0.01%	0.22				
V_n	Equivalent input noise voltage	$R_S = 20\ \Omega$, $f = 10\text{ Hz}$	15			nV/ $\sqrt{\text{Hz}}$		
		$R_S = 20\ \Omega$, $f = 1\text{ kHz}$	10.5					
$V_{N(PP)}$	Peak-to-peak equivalent input noise voltage	$f = 0.1\text{ Hz to }1\text{ Hz}$	0.48			μV		
		$f = 0.1\text{ Hz to }10\text{ Hz}$	0.51					
I_n	Equivalent input noise current	$f = 10\text{ Hz}$	1.92			pA/ $\sqrt{\text{Hz}}$		
		$f = 1\text{ kHz}$	0.5					
THD + N	Total harmonic distortion plus noise	$V_O = 1\text{ V to }3\text{ V}$, $R_L = 2\text{ k}\Omega^\dagger$, $A_{VD} = 2$, $f = 10\text{ kHz}$	0.0052%					
B_1	Unity-gain bandwidth	$R_L = 2\text{ k}\Omega^\dagger$, $C_L = 100\text{ pF}$	5.9			MHz		
	Gain-bandwidth product	$R_L = 2\text{ k}\Omega^\dagger$, $C_L = 100\text{ pF}$, $f = 100\text{ kHz}$	5.8			MHz		
B_{OM}	Maximum output-swing bandwidth	$V_{O(PP)} = 2\text{ V}$, $R_L = 2\text{ k}\Omega^\dagger$, $A_{VD} = 1$, $C_L = 100\text{ pF}$	660			kHz		
ϕ_m	Phase margin at unity gain	$R_L = 2\text{ k}\Omega^\dagger$, $C_L = 100\text{ pF}$	57°					

$^\dagger R_L$ terminates at 2.5 V.

TLE214x, TLE214xA EXCALIBUR LOW-NOISE HIGH-SPEED PRECISION OPERATIONAL AMPLIFIERS

SLOS183C – FEBRUARY 1997 – REVISED JUNE 2006

TLE2142I electrical characteristics at specified free-air temperature, $V_{CC\pm} = \pm 15\text{ V}$ (unless otherwise noted)

PARAMETER	TEST CONDITIONS	T_A †	TLE2142I			TLE2142I			UNIT
			MIN	TYP	MAX	MIN	TYP	MAX	
V_{IO} Input offset voltage	$V_{IC} = 0, V_O = 0, R_S = 50\ \Omega$	25°C	290	1200		275	750	μV	
		Full range			1800		1400		
α_{VIO} Temperature coefficient of input offset voltage		Full range	1.7			1.7		$\mu\text{V}/^\circ\text{C}$	
I_{IO} Input offset current		25°C	7	100		7	100	nA	
		Full range			200		200		
I_{IB} Input bias current		25°C	-0.7	-1.5		-0.7	-1.5	μA	
	Full range			-1.7		-1.7			
V_{ICR} Common-mode input voltage range	$R_S = 50\ \Omega$	25°C	-15 to 13	-15.3 to 13.2		-15 to 13	-15.3 to 13.2	V	
		Full range	-15 to 12.7	-15.3 to 12.9		-15 to 12.7	-15.3 to 12.9		
V_{OM+} Maximum positive peak output voltage swing	$I_O = -150\ \mu\text{A}$ $I_O = -1.5\ \text{mA}$ $I_O = -15\ \text{mA}$ $I_O = -100\ \mu\text{A}$ $I_O = -1\ \text{mA}$ $I_O = -10\ \text{mA}$	25°C	13.8	14.1		13.8	14.1	V	
			13.7	14		13.7	14		
			13.3	13.7		13.3	13.7		
		Full range	13.7			13.7			
			13.6			13.6			
			13.3			13.3			
V_{OM-} Maximum negative peak output voltage swing	$I_O = 150\ \mu\text{A}$ $I_O = 1.5\ \text{mA}$ $I_O = 15\ \text{mA}$ $I_O = 100\ \mu\text{A}$ $I_O = 1\ \text{mA}$ $I_O = 10\ \text{mA}$	25°C	-14.7	-14.9		-14.7	-14.9	V	
			-14.5	-14.8		-14.5	-14.8		
			-13.4	-13.8		-13.4	-13.8		
		Full range	-14.6			-14.6			
			-14.5			-14.5			
			-13.4			-13.4			
A_{VD} Large-signal differential voltage amplification	$V_O = \pm 10\ \text{V}, R_L = 2\ \text{k}\Omega$	25°C	100	450		100	450	V/mV	
		Full range	40			40			
r_i Input resistance		25°C	65			65	$\text{M}\Omega$		
c_i Input capacitance		25°C	2.5			2.5	pF		
z_o Open-loop output impedance	$f = 1\ \text{MHz}$	25°C	30			30	Ω		
CMRR Common-mode rejection ratio	$V_{IC} = V_{ICRmin}$	25°C	85	108		85	108	dB	
	$R_S = 50\ \Omega$	Full range	80			80			
k_{SVR} Supply-voltage rejection ratio ($\Delta V_{CC\pm} / \Delta V_{IO}$)	$V_{CC\pm} = \pm 2.5\ \text{V to } \pm 15\ \text{V}, R_S = 50\ \Omega$	25°C	90	106		90	106	dB	
		Full range	85			85			
I_{OS} Short-circuit output current	$V_O = 0$	25°C	$V_{ID} = 1\ \text{V}$	-25	-50		-25	-50	mA
			$V_{ID} = -1\ \text{V}$	20	31		20	31	
I_{CC} Supply current	$V_O = 0,$	No load	25°C	6.9	9		6.9	9	mA
			Full range			9.4		9.4	

† Full range is -40°C to 105°C .



TLE214x, TLE214xA
EXCALIBUR LOW-NOISE HIGH-SPEED
PRECISION OPERATIONAL AMPLIFIERS

SLOS183C – FEBRUARY 1997 – REVISED JUNE 2006

TLE2142I operating characteristics, $V_{CC\pm} = \pm 15\text{ V}$, $T_A = 25^\circ\text{C}$

PARAMETER	TEST CONDITIONS	TLE2142I			TLE2142AI			UNIT	
		MIN	TYP	MAX	MIN	TYP	MAX		
SR+	Positive slew rate	$A_{VD} = -1$, $C_L = 500\text{ pF}$		$R_L = 2\text{ k}\Omega$	30	45	30	45	$\text{V}/\mu\text{s}$
SR-	Negative slew rate				30	42	30	42	
t_s	Settling time	$A_{VD} = -1$, 10-V step	To 0.1%		0.34		0.34	μs	
			To 0.01%		0.4		0.4		
V_n	Equivalent input noise voltage	$R_S = 20\ \Omega$,	$f = 10\text{ Hz}$		15		15	$\text{nV}/\sqrt{\text{Hz}}$	
		$R_S = 20\ \Omega$,	$f = 1\text{ kHz}$		10.5		10.5		
$V_{N(PP)}$	Peak-to-peak equivalent input noise voltage	$f = 0.1\text{ Hz to }1\text{ Hz}$			0.48		0.48	μV	
		$f = 0.1\text{ Hz to }10\text{ Hz}$			0.51		0.51		
I_n	Equivalent input noise current	$f = 10\text{ Hz}$			1.89		1.89	$\text{pA}/\sqrt{\text{Hz}}$	
		$f = 1\text{ kHz}$			0.47		0.47		
THD + N	Total harmonic distortion plus noise	$V_{O(PP)} = 20\text{ V}$, $A_{VD} = 10$,	$R_L = 2\text{ k}\Omega$, $f = 10\text{ kHz}$		0.01%		0.01%		
B_1	Unity-gain bandwidth	$R_L = 2\text{ k}\Omega$,	$C_L = 100\text{ pF}$		6		6	MHz	
	Gain-bandwidth product	$R_L = 2\text{ k}\Omega$, $f = 100\text{ kHz}$	$C_L = 100\text{ pF}$,		5.9		5.9	MHz	
B_{OM}	Maximum output-swing bandwidth	$V_{O(PP)} = 20\text{ V}$, $A_{VD} = 1$,	$R_L = 2\text{ k}\Omega$, $C_L = 100\text{ pF}$		668		668	kHz	
ϕ_m	Phase margin at unity gain	$R_L = 2\text{ k}\Omega$,	$C_L = 100\text{ pF}$		58°		58°		

TLE214x, TLE214xA EXCALIBUR LOW-NOISE HIGH-SPEED PRECISION OPERATIONAL AMPLIFIERS

SLOS183C – FEBRUARY 1997 – REVISED JUNE 2006

TLE2144I electrical characteristics at specified free-air temperature, $V_{CC} = 5\text{ V}$ (unless otherwise noted)

PARAMETER	TEST CONDITIONS	T_A †	TLE2144I			TLE2144AI			UNIT
			MIN	TYP	MAX	MIN	TYP	MAX	
V_{IO} Input offset voltage	$V_{IC} = 0,$ $V_O = 0$ $R_S = 50\ \Omega,$	25°C	0.5	3.8		0.5	3	mV	
		Full range			4.8		4		
α_{VIO} Temperature coefficient of input offset voltage		Full range	1.7			1.7		$\mu\text{V}/^\circ\text{C}$	
I_{IO} Input offset current		25°C	8	100		8	100	nA	
		Full range			200		200		
I_{IB} Input bias current		25°C	-0.8	-2		-0.8	-2	μA	
	Full range			-2.2		-2.2			
V_{ICR} Common-mode input voltage range	$R_S = 50\ \Omega$	25°C	0 to 3	-0.3 to 3.2		0 to 3	-0.3 to 3.2	V	
		Full range	0 to 2.7	-0.3 to 2.9		0 to 2.7	-0.3 to 2.9		
V_{OH} High-level output voltage	$I_{OH} = -150\ \mu\text{A}$	25°C	3.9	4.1		3.9	4.1	V	
	$I_{OH} = -1.5\ \text{mA}$		3.8	4		3.8	4		
	$I_{OH} = -15\ \text{mA}$	3.4	3.7		3.4	3.7			
	$I_{OH} = 100\ \mu\text{A}$	Full range	3.8			3.8			
	$I_{OH} = 1\ \text{mA}$		3.7			3.7			
	$I_{OH} = 10\ \text{mA}$		3.5			3.5			
V_{OL} Low-level output voltage	$I_{OL} = 150\ \mu\text{A}$	25°C	75	125		75	125	mV	
	$I_{OL} = 1.5\ \mu\text{A}$		150	225		150	225		
	$I_{OL} = 15\ \text{mA}$		1.2	1.6		1.2	1.6		
	$I_{OL} = 100\ \mu\text{A}$	Full range			175		175	mV	
	$I_{OL} = 1\ \text{mA}$				225		225		
	$I_{OL} = 10\ \text{mA}$				1.4		1.4		
A_{VD} Large-signal differential voltage amplification	$V_{IC} = \pm 2.5\ \text{V},$ $V_O = 1\ \text{V to } -1.5\ \text{V}$ $R_L = 2\ \text{k}\Omega,$	25°C	50	95		50	95	V/mV	
		Full range	10			10			
r_i Input resistance		25°C	70			70	$\text{M}\Omega$		
c_i Input capacitance		25°C	2.5			2.5	pF		
z_o Open-loop output impedance	$f = 1\ \text{MHz}$	25°C	30			30	Ω		
CMRR Common-mode rejection ratio	$V_{IC} = V_{ICR\text{min}},$ $R_S = 50\ \Omega$	25°C	85	118		85	118	dB	
		Full range	80			80			
k_{SVR} Supply-voltage rejection ratio ($\Delta V_{CC\pm}/\Delta V_{IO}$)	$V_{CC\pm} = \pm 2.5\ \text{V to } \pm 15\ \text{V},$ $R_S = 50\ \Omega$	25°C	90	106		90	106	dB	
		Full range	85			85			
I_{CC} Supply current	$V_O = 2.5\ \text{V},$ $V_{IC} = 2.5\ \text{V}$ No load,	25°C	13.2	17.6		13.2	17.6	mA	
		Full range			18.4		18.4		

† Full range is -40°C to 105°C .



TLE214x, TLE214xA
EXCALIBUR LOW-NOISE HIGH-SPEED
PRECISION OPERATIONAL AMPLIFIERS

SLOS183C – FEBRUARY 1997 – REVISED JUNE 2006

TLE2144I operating characteristics, $V_{CC} = 5\text{ V}$, $T_A = 25^\circ\text{C}$

PARAMETER		TEST CONDITIONS		TLE2144I			TLE2144AI			UNIT
				MIN	TYP	MAX	MIN	TYP	MAX	
SR+	Positive slew rate	$A_{VD} = -1$, $C_L = 500\text{ pF}$		$R_L = 2\text{ k}\Omega^\dagger$		45			$\text{V}/\mu\text{s}$	
SR-	Negative slew rate					42				
t_s	Settling time	$A_{VD} = -1$, 2.5-V step		To 0.1%		0.16			μs	
				To 0.01%		0.22				
V_n	Equivalent input noise voltage	$R_S = 20\ \Omega$, $f = 10\text{ Hz}$		15		15			$\text{nV}/\sqrt{\text{Hz}}$	
		$R_S = 20\ \Omega$, $f = 1\text{ kHz}$		10.5		10.5				
$V_{N(PP)}$	Peak-to-peak equivalent input noise voltage	$f = 0.1\text{ Hz to }1\text{ Hz}$		0.48		0.48			μV	
		$f = 0.1\text{ Hz to }10\text{ Hz}$		0.51		0.51				
I_n	Equivalent input noise current	$f = 10\text{ Hz}$		1.92		1.92			$\text{pA}/\sqrt{\text{Hz}}$	
		$f = 10\text{ kHz}$		0.5		0.5				
THD + N	Total harmonic distortion plus noise	$V_O = 1\text{ V to }3\text{ V}$, $A_{VD} = 2$		$R_L = 2\text{ k}\Omega^\dagger$, $f = 10\text{ kHz}$		0.0052%				
B_1	Unity-gain bandwidth	$R_L = 2\text{ k}\Omega^\dagger$, $C_L = 100\text{ pF}$		5.9		5.9			MHz	
	Gain-bandwidth product	$R_L = 2\text{ k}\Omega^\dagger$, $f = 100\text{ kHz}$		5.8		5.8			MHz	
B_{OM}	Maximum output-swing bandwidth	$V_{O(PP)} = 2\text{ V}$, $A_{VD} = 1$		$R_L = 2\text{ k}\Omega^\dagger$, $C_L = 100\text{ pF}$		660			kHz	
ϕ_m	Phase margin at unity gain	$R_L = 2\text{ k}\Omega^\dagger$, $C_L = 100\text{ pF}$		57°		57°				

$^\dagger R_L$ terminates at 2.5 V

TLE214x, TLE214xA EXCALIBUR LOW-NOISE HIGH-SPEED PRECISION OPERATIONAL AMPLIFIERS

SLOS183C – FEBRUARY 1997 – REVISED JUNE 2006

TLE2144I electrical characteristics at specified free-air temperature, $V_{CC\pm} = \pm 15\text{ V}$ (unless otherwise noted)

PARAMETER	TEST CONDITIONS	T_A †	TLE2144I			TLE2144AI			UNIT
			MIN	TYP	MAX	MIN	TYP	MAX	
V_{IO} Input offset voltage	$V_{IC} = 0,$ $V_O = 0$ $R_S = 50\ \Omega$	25°C	0.6	2.4		0.5	1.5	mV	
		Full range			3.2		2.8		
α_{VIO} Temperature coefficient of input offset voltage		Full range	1.7			1.7		$\mu\text{V}/^\circ\text{C}$	
I_{IO} Input offset current		25°C	7	100		7	100	nA	
		Full range			200		200		
I_{IB} Input bias current		25°C	-0.7	-1.5		-0.7	-1.5	μA	
	Full range			-1.7		-1.7			
V_{ICR} Common-mode input voltage range	$R_S = 50\ \Omega$	25°C	-15 to 13	-15.3 to 13.2		-15 to 13	-15.3 to 13.2	V	
		Full range	-15 to 12.7	-15.3 to 12.9		-15 to 12.7	-15.3 to 12.9		
V_{OM+} Maximum positive peak output voltage swing	$I_O = -150\ \mu\text{A}$ $I_O = -1.5\ \text{mA}$ $I_O = -15\ \text{mA}$ $I_O = -100\ \mu\text{A}$ $I_O = -1\ \text{mA}$ $I_O = -10\ \text{mA}$	25°C	13.8	14.1		13.8	14.1	V	
			13.7	14		13.7	14		
			13.1	13.7		13.1	13.7		
		Full range	13.7			13.7			
			13.6			13.6			
			13.1			13.1			
V_{OM-} Maximum negative peak output voltage swing	$I_O = 150\ \mu\text{A}$ $I_O = 1.5\ \text{mA}$ $I_O = 15\ \text{mA}$ $I_O = 100\ \mu\text{A}$ $I_O = 1\ \text{mA}$ $I_O = 10\ \text{mA}$	25°C	-14.7	-14.9		-14.7	-14.9	V	
			-14.5	-14.8		-14.5	-14.8		
			-13.4	-13.8		-13.4	-13.8		
		Full range	-14.6			-14.6			
			-14.5			-14.5			
			-13.4			-13.4			
A_{VD} Large-signal differential voltage amplification	$V_O = \pm 10\ \text{V},$ $R_L = 2\ \text{k}\Omega$	25°C	100	170		100	170	V/mV	
		Full range	40			40			
r_i Input resistance		25°C	65			65	$\text{M}\Omega$		
c_i Input capacitance		25°C	2.5			2.5	pF		
z_o Open-loop output impedance	$f = 1\ \text{MHz}$	25°C	30			30	Ω		
CMRR Common-mode rejection ratio	$V_{IC} = V_{ICRmin},$ $R_S = 50\ \Omega$	25°C	85	108		85	108	dB	
		Full range	80			80			
k_{SVR} Supply-voltage rejection ratio ($\Delta V_{CC\pm} / \Delta V_{IO}$)	$V_{CC\pm} = \pm 2.5\ \text{V to } \pm 15\ \text{V},$ $R_S = 50\ \Omega$	25°C	90	106		90	106	dB	
		Full range	85			85			
I_{OS} Short-circuit output current	$V_O = 0$ $V_{ID} = 1\ \text{V}$ $V_{ID} = -1\ \text{V}$	25°C	-25	-50		-25	-50	mA	
			20	31		20	31		
I_{CC} Supply current	$V_O = 0,$ No load	25°C	13.8	18		13.8	18	mA	
		Full range			18.8		18.8		

† Full range is -40°C to 105°C.



TLE214x, TLE214xA
EXCALIBUR LOW-NOISE HIGH-SPEED
PRECISION OPERATIONAL AMPLIFIERS

SLOS183C – FEBRUARY 1997 – REVISED JUNE 2006

TLE2144I operating characteristics, $V_{CC\pm} = \pm 15\text{ V}$, $T_A = 25^\circ\text{C}$

PARAMETER		TEST CONDITIONS		TLE2144I			TLE2144AI			UNIT
				MIN	TYP	MAX	MIN	TYP	MAX	
SR+	Positive slew rate	$A_{VD} = -1$, $C_L = 500\text{ pF}$	$R_L = 2\text{ k}\Omega$	27	45		27	45	$\text{V}/\mu\text{s}$	
SR-	Negative slew rate			27	42		27	42		
t_s	Settling time	$A_{VD} = -1$, 10-V step	To 0.1%	0.34			0.34			μs
			To 0.01%	0.4			0.4			
V_n	Equivalent input noise voltage	$R_S = 20\ \Omega$	$f = 10\text{ Hz}$	15			15			$\text{nV}/\sqrt{\text{Hz}}$
			$f = 1\text{ kHz}$	10.5			10.5			
$V_{N(PP)}$	Peak-to-peak equivalent input noise voltage	$f = 0.1\text{ Hz to }1\text{ Hz}$		0.48			0.48			μV
		$f = 0.1\text{ Hz to }10\text{ Hz}$		0.51			0.51			
I_n	Equivalent input noise current	$f = 10\text{ Hz}$		1.89			1.89			$\text{pA}/\sqrt{\text{Hz}}$
		$f = 1\text{ kHz}$		0.47			0.47			
THD + N	Total harmonic distortion plus noise	$V_{O(PP)} = 20\text{ V}$, $A_{VD} = 10$,	$R_L = 2\text{ k}\Omega$, $f = 10\text{ kHz}$	0.01%			0.01%			
B_1	Unity-gain bandwidth	$R_L = 2\text{ k}\Omega$,	$C_L = 100\text{ pF}$	6			6			MHz
	Gain-bandwidth product	$R_L = 2\text{ k}\Omega$, $f = 100\text{ kHz}$	$C_L = 100\text{ pF}$,	5.9			5.9			MHz
B_{OM}	Maximum output-swing bandwidth	$V_{O(PP)} = 20\text{ V}$, $A_{VD} = 1$,	$R_L = 2\text{ k}\Omega$, $C_L = 100\text{ pF}$	668			668			kHz
ϕ_m	Phase margin at unity gain	$R_L = 2\text{ k}\Omega$,	$C_L = 100\text{ pF}$	58°			58°			

TLE214x, TLE214xA EXCALIBUR LOW-NOISE HIGH-SPEED PRECISION OPERATIONAL AMPLIFIERS

SLOS183C – FEBRUARY 1997 – REVISED JUNE 2006

TLE2141M electrical characteristics at specified free-air temperature, $V_{CC} = 5\text{ V}$ (unless otherwise noted)

PARAMETER	TEST CONDITIONS	T_A †	TLE2141M			TLE2141AM			UNIT
			MIN	TYP	MAX	MIN	TYP	MAX	
V_{IO} Input offset voltage	$V_O = 2.5\text{ V}$ $V_{IC} = 2.5\text{ V}$ $R_S = 50\ \Omega$	25°C	225	1400		200	1000	μV	
		Full range			2100		1700		
α_{VIO} Temperature coefficient of input offset voltage		Full range	1.7			1.7		$\mu\text{V}/^\circ\text{C}$	
I_{IO} Input offset current		25°C	8	100		8	100	nA	
		Full range			250		250		
I_{IB} Input bias current		25°C	-0.8	-2		-0.8	-2	μA	
	Full range			-2.3		-2.3			
V_{ICR} Common-mode input voltage range	$R_S = 50\ \Omega$	25°C	0 to 3	-0.3 to 3.2		0 to 3	-0.3 to 3.2	V	
		Full range	0 to 2.7	-0.3 to 2.9		0 to 2.7	-0.3 to 2.9		
V_{OH} High-level output voltage	$I_{OH} = -150\ \mu\text{A}$ $I_{OH} = -1.5\text{ mA}$ $I_{OH} = -15\text{ mA}$ $I_{OH} = -100\ \mu\text{A}$ $I_{OH} = -1\text{ mA}$ $I_{OH} = -10\text{ mA}$	25°C	3.9	4.1		3.9	4.1	V	
			3.8	4		3.8	4		
			3.2	3.7		3.2	3.7		
		Full range	3.75			3.75			
			3.65			3.65			
			3.25			3.25			
V_{OL} Low-level output voltage	$I_{OL} = 150\ \mu\text{A}$ $I_{OL} = 1.5\text{ mA}$ $I_{OL} = 15\text{ mA}$ $I_{OL} = 100\ \mu\text{A}$ $I_{OL} = 1\text{ mA}$ $I_{OL} = 10\text{ mA}$	25°C	75	125		75	125	mV	
			150	225		150	225		
			1.2	1.4		1.2	1.4		
		Full range	200			200			
			250			225			
			1.25			1.25			
A_{VD} Large-signal differential voltage amplification	$V_{IC} = \pm 2.5\text{ V}$, $R_L = 2\text{ k}\Omega$, $V_O = 1\text{ V to } -1.5\text{ V}$	25°C	50	220		50	220	V/mV	
		Full range	5			5			
r_i Input resistance		25°C	70			70	$\text{M}\Omega$		
c_i Input capacitance		25°C	2.5			2.5	pF		
z_o Open-loop output impedance	$f = 1\text{ MHz}$	25°C	30			30	Ω		
CMRR Common-mode rejection ratio	$V_{IC} = V_{ICRmin}$, $R_S = 50\ \Omega$	25°C	85	118		85	118	dB	
		Full range	80			80			
k_{SVR} Supply-voltage rejection ratio ($\Delta V_{CC\pm} / \Delta V_{IO}$)	$V_{CC\pm} = \pm 2.5\text{ V to } \pm 15\text{ V}$, $R_S = 50\ \Omega$	25°C	90	106		90	106	dB	
		Full range	85			85			
I_{CC} Supply current	$V_O = 2.5\text{ V}$, $V_{IC} = 2.5\text{ V}$ No load,	25°C	3.4	4.4		3.4	4.4	mA	
		Full range			4.6		4.6		

† Full range is -55°C to 125°C .



TLE214x, TLE214xA
EXCALIBUR LOW-NOISE HIGH-SPEED
PRECISION OPERATIONAL AMPLIFIERS

SLOS183C – FEBRUARY 1997 – REVISED JUNE 2006

TLE2141M operating characteristics, $V_{CC} = 5\text{ V}$, $T_A = 25^\circ\text{C}$

PARAMETER	TEST CONDITIONS	TLE2141M			TLE2141AM			UNIT
		MIN	TYP	MAX	MIN	TYP	MAX	
SR+	Positive slew rate	$A_{VD} = -1$, $C_L = 500\text{ pF}$		$R_L = 2\text{ k}\Omega^\dagger$		45		V/ μs
SR-	Negative slew rate					42		
t_s	Settling time	$A_{VD} = -1$, 2.5-V step		To 0.1%		0.16		μs
				To 0.01%		0.22		
V_n	Equivalent input noise voltage	$R_S = 20\ \Omega$, $f = 10\text{ Hz}$		15		15		nV/ $\sqrt{\text{Hz}}$
		$R_S = 20\ \Omega$, $f = 1\text{ kHz}$		10.5		10.5		
$V_{N(PP)}$	Peak-to-peak equivalent input noise voltage	$f = 0.1\text{ Hz to }1\text{ Hz}$		0.48		0.48		μV
		$f = 0.1\text{ Hz to }10\text{ Hz}$		0.51		0.51		
I_n	Equivalent input noise current	$f = 10\text{ Hz}$		1.92		1.92		pA/ $\sqrt{\text{Hz}}$
		$f = 1\text{ kHz}$		0.5		0.5		
THD + N	Total harmonic distortion plus noise	$V_O = 1\text{ V to }3\text{ V}$, $A_{VD} = 2$,		$R_L = 2\text{ k}\Omega^\dagger$, $f = 10\text{ kHz}$		0.0052%		
B_1	Unity-gain bandwidth	$R_L = 2\text{ k}\Omega^\dagger$, $C_L = 100\text{ pF}^\dagger$		5.9		5.9		MHz
	Gain-bandwidth product	$R_L = 2\text{ k}\Omega^\dagger$, $f = 100\text{ kHz}$		5.8		5.8		MHz
B_{OM}	Maximum output-swing bandwidth	$V_{O(PP)} = 2\text{ V}$, $A_{VD} = 1$		$R_L = 2\text{ k}\Omega^\dagger$		660		kHz
ϕ_m	Phase margin at unity gain	$R_L = 2\text{ k}\Omega^\dagger$, $C_L = 100\text{ pF}^\dagger$		57°		57°		

$^\dagger R_L$ and C_L terminated to 2.5 V.

TLE214x, TLE214xA EXCALIBUR LOW-NOISE HIGH-SPEED PRECISION OPERATIONAL AMPLIFIERS

SLOS183C – FEBRUARY 1997 – REVISED JUNE 2006

TLE2141M electrical characteristics at specified free-air temperature, $V_{CC\pm} = \pm 15$ V (unless otherwise noted)

PARAMETER	TEST CONDITIONS	T_A †	TLE2141M			TLE2141AM			UNIT
			MIN	TYP	MAX	MIN	TYP	MAX	
V_{IO} Input offset voltage	$V_{IC} = 0, R_S = 50 \Omega$	25°C	200	900		175	500	μV	
		Full range			1700		1200		
α_{VIO} Temperature coefficient of input offset voltage		Full range	1.7			1.7		$\mu V/^\circ C$	
I_{IO} Input offset current		25°C	7	100		7	100	nA	
		Full range			250		250		
I_{IB} Input bias current		25°C	-0.7	-1.5		-0.7	-1.5	μA	
	Full range			-1.8		-1.8			
V_{ICR} Common-mode input voltage range	$R_S = 50 \Omega$	25°C	-15 to 13	-15.3 to 13.2		-15 to 13	-15.3 to 13.2	V	
		Full range	-15 to 12.7	-15.3 to 12.9		-15 to 12.7	-15.3 to 12.9		
V_{OM+} Maximum positive peak output voltage swing	$I_O = -150 \mu A$ $I_O = -1.5 mA$ $I_O = -15 mA$ $I_O = -100 \mu A$ $I_O = -1 mA$ $I_O = -10 mA$	25°C	13.8	14.1		13.8	14.1	V	
			13.7	14		13.7	14		
			13.1	13.7		13.1	13.7		
		Full range	13.7			13.7			
			13.6			13.6			
			13.1			13.1			
V_{OM-} Maximum negative peak output voltage swing	$I_O = 150 \mu A$ $I_O = 1.5 mA$ $I_O = 15 mA$ $I_O = 100 \mu A$ $I_O = 1 mA$ $I_O = 10 mA$	25°C	-14.7	-14.9		-14.7	-14.9	V	
			-14.5	-14.8		-14.5	-14.8		
			-13.4	-13.8		-13.4	-13.8		
		Full range	-14.6			-14.6			
			-14.5			-14.5			
			-13.4			-13.4			
A_{VD} Large-signal differential voltage amplification	$V_O = \pm 10 V, R_L = 2 k\Omega$	25°C	100	450		100	450	V/mV	
		Full range	20			20			
r_i Input resistance		25°C	65			65	$M\Omega$		
c_i Input capacitance		25°C	2.5			2.5	pF		
z_o Open-loop output impedance	$f = 1 MHz$	25°C	30			30	Ω		
CMRR Common-mode rejection ratio	$V_{IC} = V_{ICRmin}, R_S = 50 \Omega$	25°C	85	108		85	108	dB	
		Full range	80			80			
k_{SVR} Supply-voltage rejection ratio ($\Delta V_{CC\pm} / \Delta V_{IO}$)	$V_{CC\pm} = \pm 2.5 V$ to $\pm 15 V, R_S = 50 \Omega$	25°C	90	106		90	106	dB	
		Full range	85			85			
I_{OS} Short-circuit output current	$V_O = 0$	25°C	$V_{ID} = 1 V$	-25	-50		-25	-50	mA
			$V_{ID} = -1 V$	20	31		20	31	
I_{CC} Supply current	$V_O = 0, V_{IC} = 2.5 V$	25°C	3.5	4.5		3.5	4.5	mA	
			Full range			4.7			4.7

† Full range is $-55^\circ C$ to $125^\circ C$.



TLE214x, TLE214xA
EXCALIBUR LOW-NOISE HIGH-SPEED
PRECISION OPERATIONAL AMPLIFIERS

SLOS183C – FEBRUARY 1997 – REVISED JUNE 2006

TLE2141M operating characteristics, $V_{CC\pm} = \pm 15\text{ V}$, $T_A = 25^\circ\text{C}$

PARAMETER		TEST CONDITIONS		TLE2141M			TLE2141AM			UNIT
				MIN	TYP	MAX	MIN	TYP	MAX	
SR+	Positive slew rate	$A_{VD} = -1$, $C_L = 100\text{ pF}$	$R_L = 2\text{ k}\Omega$	27	45		27	45	V/ μs	
SR-	Negative slew rate			27	42		27	42		
t_s	Settling time	$A_{VD} = -1$, 10-V step	To 0.1%	0.34			0.34			μs
			To 0.01%	0.4			0.4			
V_n	Equivalent input noise voltage	$R_S = 20\ \Omega$	$f = 10\text{ Hz}$	15			15			nV/ $\sqrt{\text{Hz}}$
			$f = 1\text{ kHz}$	10.5			10.5			
$V_{N(PP)}$	Peak-to-peak equivalent input noise voltage	$f = 0.1\text{ Hz to }1\text{ Hz}$		0.48			0.48			μV
		$f = 0.1\text{ Hz to }10\text{ Hz}$		0.51			0.51			
I_n	Equivalent input noise current	$f = 10\text{ Hz}$		1.89			1.89			pA/ $\sqrt{\text{Hz}}$
		$f = 1\text{ kHz}$		0.47			0.47			
THD + N	Total harmonic distortion plus noise	$V_{O(PP)} = 20\text{ V}$, $A_{VD} = 10$	$R_L = 2\text{ k}\Omega$, $f = 10\text{ kHz}$	0.01%			0.01%			
B_1	Unity-gain bandwidth	$R_L = 2\text{ k}\Omega$	$C_L = 100\text{ pF}$	6			6			MHz
	Gain-bandwidth product	$R_L = 2\text{ k}\Omega$, $f = 100\text{ kHz}$	$C_L = 100\text{ pF}$	5.9			5.9			MHz
B_{OM}	Maximum output-swing bandwidth	$V_{O(PP)} = 20\text{ V}$, $A_{VD} = 1$	$R_L = 2\text{ k}\Omega$, $C_L = 100\text{ pF}$	668			668			kHz
ϕ_m	Phase margin at unity gain	$R_L = 2\text{ k}\Omega$	$C_L = 100\text{ pF}$	58°			58°			

TLE214x, TLE214xA EXCALIBUR LOW-NOISE HIGH-SPEED PRECISION OPERATIONAL AMPLIFIERS

SLOS183C – FEBRUARY 1997 – REVISED JUNE 2006

TLE2142M electrical characteristics at specified free-air temperature, $V_{CC} = 5\text{ V}$ (unless otherwise noted)

PARAMETER	TEST CONDITIONS	T_A †	TLE2142M			TLE2142AM			UNIT
			MIN	TYP	MAX	MIN	TYP	MAX	
V_{IO} Input offset voltage	$V_O = 2.5\text{ V},$ $V_{IC} = 2.5\text{ V}$ $R_S = 50\ \Omega,$	25°C	220	1900		200	1500	μV	
		Full range			2600		2200		
α_{VIO} Temperature coefficient of input offset voltage		Full range	1.7			1.7		$\mu\text{V}/^\circ\text{C}$	
I_{IO} Input offset current		25°C	8	100		8	100	nA	
		Full range			200		200		
I_{IB} Input bias current		25°C	-0.8	-2		-0.8	-2	μA	
	Full range			-2.3		-2.3			
V_{ICR} Common-mode input voltage range	$R_S = 50\ \Omega$	25°C	0 to 3	-0.3 to 3.2		0 to 3	-0.3 to 3.2	V	
		Full range	0 to 2.7	-0.3 to 2.9		0 to 2.7	-0.3 to 2.9		
V_{OH} High-level output voltage	$I_{OH} = -150\ \mu\text{A}$	25°C	3.9	4.1		3.9	4.1	V	
	$I_{OH} = -1.5\text{ mA}$		3.8	4		3.8	4		
	$I_{OH} = -15\text{ mA}$		3.4	3.7		3.4	3.7		
	$I_{OH} = 100\ \mu\text{A}$	Full range	3.75			3.75			
	$I_{OH} = 1\text{ mA}$		3.65			3.65			
	$I_{OH} = 10\text{ mA}$		3.45			3.45			
V_{OL} Low-level output voltage	$I_{OL} = 150\ \mu\text{A}$	25°C	75	125		75	125	mV	
	$I_{OL} = 1.5\text{ mA}$		150	225		150	225		
	$I_{OL} = 15\text{ mA}$		1.2	1.4		1.2	1.4	V	
	$I_{OL} = 100\ \mu\text{A}$	Full range			200		200	mV	
	$I_{OL} = 1\text{ mA}$				250		250		
	$I_{OL} = 10\text{ mA}$				1.25		1.25	V	
A_{VD} Large-signal differential voltage amplification	$V_{IC} = \pm 2.5\text{ V},$ $R_L = 2\text{ k}\Omega,$ $V_O = 1\text{ V to } -1.5\text{ V}$	25°C	50	220		50	220	V/mV	
		Full range	5			5			
r_i Input resistance		25°C	70			70	$\text{M}\Omega$		
c_i Input capacitance		25°C	2.5			2.5	pF		
z_o Open-loop output impedance	$f = 1\text{ MHz}$	25°C	30			30	Ω		
CMRR Common-mode rejection ratio	$V_{IC} = V_{ICRmin},$ $R_S = 50\ \Omega$	25°C	85	118		85	118	dB	
		Full range	80			80			
k_{SVR} Supply-voltage rejection ratio ($\Delta V_{CC\pm} / \Delta V_{IO}$)	$V_{CC\pm} = \pm 2.5\text{ V to } \pm 15\text{ V},$ $R_S = 50\ \Omega$	25°C	90	106		90	106	dB	
		Full range	85			85			
I_{CC} Supply current	$V_O = 2.5\text{ V},$ $V_{IC} = 2.5\text{ V}$ No load,	25°C	6.6	8.8		6.6	8.8	mA	
		Full range			9.2		9.2		

† Full range is -55°C to 125°C .



TLE214x, TLE214xA
EXCALIBUR LOW-NOISE HIGH-SPEED
PRECISION OPERATIONAL AMPLIFIERS

SLOS183C – FEBRUARY 1997 – REVISED JUNE 2006

TLE2142M operating characteristics, $V_{CC} = 5\text{ V}$, $T_A = 25^\circ\text{C}$

PARAMETER	TEST CONDITIONS	TLE2142M			TLE2142AM			UNIT
		MIN	TYP	MAX	MIN	TYP	MAX	
SR+	Positive slew rate	$A_{VD} = -1$, $C_L = 500\text{ pF}$		$R_L = 2\text{ k}\Omega^\dagger$		45		$\text{V}/\mu\text{s}$
SR-	Negative slew rate					42		
t_s	Settling time	$A_{VD} = -1$, 2.5-V step	To 0.1%	0.16		0.16		μs
			To 0.01%	0.22		0.22		
V_n	Equivalent input noise voltage	$R_S = 20\ \Omega$, $f = 10\text{ Hz}$	15		15		$\text{nV}/\sqrt{\text{Hz}}$	
		$R_S = 20\ \Omega$, $f = 1\text{ kHz}$	10.5		10.5			
$V_{N(PP)}$	Peak-to-peak equivalent input noise voltage	$f = 0.1\text{ Hz to }1\text{ Hz}$		0.48		0.48		μV
		$f = 0.1\text{ Hz to }10\text{ Hz}$		0.51		0.51		
I_n	Equivalent input noise current	$f = 10\text{ Hz}$		1.92		1.92		$\text{pA}/\sqrt{\text{Hz}}$
		$f = 1\text{ kHz}$		0.5		0.5		
THD + N	Total harmonic distortion plus noise	$V_O = 1\text{ V to }3\text{ V}$, $A_{VD} = 2$,	$R_L = 2\text{ k}\Omega^\dagger$, $f = 10\text{ kHz}$	0.0052%		0.0052%		
B_1	Unity-gain bandwidth	$R_L = 2\text{ k}\Omega^\dagger$,	$C_L = 100\text{ pF}$	5.9		5.9		MHz
	Gain-bandwidth product	$R_L = 2\text{ k}\Omega^\dagger$, $f = 100\text{ kHz}$	$C_L = 100\text{ pF}$	5.8		5.8		MHz
B_{OM}	Maximum output-swing bandwidth	$V_{O(PP)} = 2\text{ V}$, $A_{VD} = 1$,	$R_L = 2\text{ k}\Omega^\dagger$, $C_L = 100\text{ pF}$	660		660		kHz
ϕ_m	Phase margin	$R_L = 2\text{ k}\Omega^\dagger$,	$C_L = 100\text{ pF}$	57°		57°		

$^\dagger R_L$ terminates at 2.5 V.

TLE214x, TLE214xA EXCALIBUR LOW-NOISE HIGH-SPEED PRECISION OPERATIONAL AMPLIFIERS

SLOS183C – FEBRUARY 1997 – REVISED JUNE 2006

TLE2142M electrical characteristics at specified free-air temperature, $V_{CC\pm} = \pm 15$ V (unless otherwise noted)

PARAMETER	TEST CONDITIONS	T_A †	TLE2142M			TLE2142AM			UNIT
			MIN	TYP	MAX	MIN	TYP	MAX	
V_{IO} Input offset voltage	$V_{IC} = 0, R_S = 50 \Omega$	25°C	290	1200		275	750	μV	
		Full range		2000		1600			
α_{VIO} Temperature coefficient of input offset voltage		Full range	1.7			1.7		$\mu V/^\circ C$	
I_{IO} Input offset current		25°C	7	100		7	100	nA	
		Full range		250		250			
I_{IB} Input bias current		25°C	-0.7	-1.5		-0.7	-1.5	μA	
	Full range		-1.8		-1.8				
V_{ICR} Common-mode input voltage range	$R_S = 50 \Omega$	25°C	-15 to 13	-15.3 to 13.2		-15 to 13	-15.3 to 13.2	V	
		Full range	-15 to 12.7	-15.3 to 12.9		-15 to 12.7	-15.3 to 12.9		
V_{OM+} Maximum positive peak output voltage swing	$I_O = -150 \mu A$	25°C	13.8	14.1		13.8	14.1	V	
	$I_O = -1.5 mA$		13.7	14		13.7	14		
	$I_O = -15 mA$		13.3	13.7		13.3	13.7		
	$I_O = -100 \mu A$	Full range	13.7			13.7			
	$I_O = -1 mA$		13.6			13.6			
	$I_O = -10 mA$		13.3			13.3			
V_{OM-} Maximum negative peak output voltage swing	$I_O = 150 \mu A$	25°C	-14.7	-14.9		-14.7	-14.9	V	
	$I_O = 1.5 mA$		-14.5	-14.8		-14.5	-14.8		
	$I_O = 15 mA$		-13.4	-13.8		-13.4	-13.8		
	$I_O = 100 \mu A$	Full range	-14.6			-14.6			
	$I_O = 1 mA$		-14.5			-14.5			
	$I_O = 10 mA$		-13.4			-13.4			
A_{VD} Large-signal differential voltage amplification	$V_O = \pm 10 V, R_L = 2 k\Omega$	25°C	100	450		100	450	V/mV	
		Full range	20			20			
r_i Input resistance		25°C	65			65	$M\Omega$		
c_i Input capacitance		25°C	2.5			2.5	pF		
z_o Open-loop output impedance	$f = 1 MHz$	25°C	30			30	Ω		
CMRR Common-mode rejection ratio	$V_{IC} = V_{ICRmin}, R_S = 50 \Omega$	25°C	85	108		85	108	dB	
		Full range	80			80			
k_{SVR} Supply-voltage rejection ratio ($\Delta V_{CC\pm} / \Delta V_{IO}$)	$V_{CC\pm} = \pm 2.5 V$ to $\pm 15 V, R_S = 50 \Omega$	25°C	90	106		90	106	dB	
		Full range	85			85			
I_{OS} Short-circuit output current	$V_O = 0$	25°C	$V_{ID} = 1 V$	-25	-50		-25	-50	mA
			$V_{ID} = -1 V$	20	31		20	31	
I_{CC} Supply current	$V_O = 0, V_{IC} = 2.5 V$	No load,	25°C	6.9	9		6.9	9	mA
			Full range		9.4			9.4	

† Full range is $-55^\circ C$ to $125^\circ C$.



TLE214x, TLE214xA
EXCALIBUR LOW-NOISE HIGH-SPEED
PRECISION OPERATIONAL AMPLIFIERS

SLOS183C – FEBRUARY 1997 – REVISED JUNE 2006

TLE2142M operating characteristics, $V_{CC\pm} = \pm 15\text{ V}$, $T_A = 25^\circ\text{C}$

PARAMETER	TEST CONDITIONS	TLE2142M			TLE2142AM			UNIT
		MIN	TYP	MAX	MIN	TYP	MAX	
SR+	Positive slew rate	$R_L = 2\text{ k}\Omega$, $A_{VD} = -1$, $C_L = 100\text{ pF}$		27	45	27	45	V/ μs
SR-	Negative slew rate			27	42	27	42	
t_s	Settling time	$A_{VD} = -1$, 10-V step	To 0.1%	0.34			μs	
			To 0.01%	0.4				
V_n	Equivalent input noise voltage	$R_S = 20\ \Omega$, $f = 10\text{ Hz}$	15			nV/ $\sqrt{\text{Hz}}$		
		$R_S = 20\ \Omega$, $f = 1\text{ kHz}$	10.5					
$V_{N(PP)}$	Peak-to-peak equivalent input noise voltage	$f = 0.1\text{ Hz to }1\text{ Hz}$	0.48			μV		
		$f = 0.1\text{ Hz to }10\text{ Hz}$	0.51					
I_n	Equivalent input noise current	$f = 10\text{ Hz}$	1.89			pA/ $\sqrt{\text{Hz}}$		
		$f = 1\text{ kHz}$	0.47					
THD + N	Total harmonic distortion plus noise	$V_{O(PP)} = 20\text{ V}$, $R_L = 2\text{ k}\Omega$, $A_{VD} = 10$, $f = 10\text{ kHz}$	0.01%					
B_1	Unity-gain bandwidth	$R_L = 2\text{ k}\Omega$, $C_L = 100\text{ pF}$	6			MHz		
	Gain-bandwidth product	$R_L = 2\text{ k}\Omega$, $C_L = 100\text{ pF}$, $f = 100\text{ kHz}$	5.9			MHz		
B_{OM}	Maximum output-swing bandwidth	$V_{O(PP)} = 20\text{ V}$, $R_L = 2\text{ k}\Omega$, $A_{VD} = 1$, $C_L = 100\text{ pF}$	668			kHz		
ϕ_m	Phase margin at unity gain	$R_L = 2\text{ k}\Omega$, $C_L = 100\text{ pF}$	58°					

TLE214x, TLE214xA EXCALIBUR LOW-NOISE HIGH-SPEED PRECISION OPERATIONAL AMPLIFIERS

SLOS183C – FEBRUARY 1997 – REVISED JUNE 2006

TLE2144M electrical characteristics at specified free-air temperature, $V_{CC} = 5\text{ V}$ (unless otherwise noted)

PARAMETER	TEST CONDITIONS	T_A †	TLE2144M			TLE2144AM			UNIT
			MIN	TYP	MAX	MIN	TYP	MAX	
V_{IO} Input offset voltage	$V_O = 2.5\text{ V}$, $V_{IC} = 2.5\text{ V}$ $R_S = 50\ \Omega$	25°C	0.5	3.8		0.5	3	mV	
		Full range			5.2		4.4		
α_{VIO} Temperature coefficient of input offset voltage		Full range		1.7			1.7	$\mu\text{V}/^\circ\text{C}$	
		25°C		8	100		8		100
I_{IO} Input offset current		25°C						nA	
		Full range			250		250		
I_{IB} Input bias current		25°C		-0.8	-2		-0.8	-2	μA
		Full range			-2.3		-2.3		
V_{ICR} Common-mode input voltage range	$R_S = 50\ \Omega$	25°C	0 to 3	-0.3 to 3.2		0 to 3	-0.3 to 3.2	V	
		Full range	0 to 2.7	-0.3 to 2.9		0 to 2.7	-0.3 to 2.9		
V_{OH} High-level output voltage	$I_{OH} = -150\ \mu\text{A}$ $I_{OH} = -1.5\text{ mA}$ $I_{OH} = -15\text{ mA}$ $I_{OH} = 100\ \mu\text{A}$ $I_{OH} = 1\text{ mA}$ $I_{OH} = 10\text{ mA}$	25°C		3.9	4.1		3.9	4.1	V
				3.8	4		3.8	4	
				3.4	3.7		3.4	3.7	
		Full range		3.75			3.75		
				3.65			3.65		
				3.45			3.45		
V_{OL} Low-level output voltage	$I_{OL} = 150\ \mu\text{A}$ $I_{OL} = 1.5\ \mu\text{A}$ $I_{OL} = 15\text{ mA}$ $I_{OL} = 100\ \mu\text{A}$ $I_{OL} = 1\text{ mA}$ $I_{OL} = 10\text{ mA}$	25°C		75	125		75	125	mV
				150	225		150	225	
				1.2	1.6		1.2	1.6	
		Full range			200			200	
					250			250	
					1.45			1.45	
AVD Large-signal differential voltage amplification	$V_{IC} = \pm 2.5\text{ V}$, $V_O = 1\text{ V to } -1.5\text{ V}$, $R_L = 2\text{ k}\Omega$	25°C	50	95		50	95	V/mV	
		Full range		5			5		
r_i Input resistance		25°C		70		70	$M\Omega$		
c_i Input capacitance		25°C		2.5		2.5	pF		
z_o Open-loop output impedance	$f = 1\text{ MHz}$	25°C		30		30	Ω		
CMRR Common-mode rejection ratio	$V_{IC} = V_{ICRmin}$, $R_S = 50\ \Omega$	25°C	85	118		85	118	dB	
		Full range		80			80		
k_{SVR} Supply-voltage rejection ratio ($\Delta V_{CC\pm} / \Delta V_{IO}$)	$V_{CC\pm} = \pm 2.5\text{ V to } \pm 15\text{ V}$, $R_S = 50\ \Omega$	25°C	90	106		90	106	dB	
		Full range		85			85		
I_{CC} Supply current	$V_O = 2.5\text{ V}$, $V_{IC} = 2.5\text{ V}$, No load,	25°C		13.2	17.6		13.2	17.6	mA
		Full range			18.4			18.4	

† Full range is -55°C to 125°C .



TLE214x, TLE214xA
EXCALIBUR LOW-NOISE HIGH-SPEED
PRECISION OPERATIONAL AMPLIFIERS

SLOS183C – FEBRUARY 1997 – REVISED JUNE 2006

TLE2144M operating characteristics, $V_{CC} = 5\text{ V}$, $T_A = 25^\circ\text{C}$

PARAMETER	TEST CONDITIONS	TLE2144M			TLE2144AM			UNIT
		MIN	TYP	MAX	MIN	TYP	MAX	
SR+	Positive slew rate	$A_{VD} = -1$, $C_L = 500\text{ pF}$		$R_L = 2\text{ k}\Omega^\dagger$		45		$\text{V}/\mu\text{s}$
SR-	Negative slew rate					42		
t_s	Settling time	$A_{VD} = -1$, 2.5-V step	To 0.1%		0.16		μs	
			To 0.01%		0.22			
V_n	Equivalent input noise voltage	$R_S = 20\ \Omega$, $f = 10\text{ Hz}$		15		$\text{nV}/\sqrt{\text{Hz}}$		
		$R_S = 20\ \Omega$, $f = 1\text{ kHz}$		10.5				
$V_{N(PP)}$	Peak-to-peak equivalent input noise voltage	$f = 0.1\text{ Hz to }1\text{ Hz}$		0.48		μV		
		$f = 0.1\text{ Hz to }10\text{ Hz}$		0.51				
I_n	Equivalent input noise current	$f = 10\text{ Hz}$		1.92		$\text{pA}/\sqrt{\text{Hz}}$		
		$f = 1\text{ kHz}$		0.5				
THD + N	Total harmonic distortion plus noise	$V_O = 1\text{ V to }3\text{ V}$, $R_L = 2\text{ k}\Omega^\dagger$, $A_{VD} = 2$, $f = 10\text{ kHz}$		0.0052%				
B_1	Unity-gain bandwidth	$R_L = 2\text{ k}\Omega^\dagger$, $C_L = 100\text{ pF}$		5.9		MHz		
	Gain-bandwidth product	$R_L = 2\text{ k}\Omega^\dagger$, $C_L = 100\text{ pF}$, $f = 100\text{ kHz}$		5.8		MHz		
B_{OM}	Maximum output-swing bandwidth	$V_{O(PP)} = 2\text{ V}$, $R_L = 2\text{ k}\Omega^\dagger$, $A_{VD} = 1$		660		kHz		
ϕ_m	Phase margin	$R_L = 2\text{ k}\Omega^\dagger$, $C_L = 100\text{ pF}$		57°				

$^\dagger R_L$ terminates at 2.5 V

TLE214x, TLE214xA EXCALIBUR LOW-NOISE HIGH-SPEED PRECISION OPERATIONAL AMPLIFIERS

SLOS183C – FEBRUARY 1997 – REVISED JUNE 2006

TLE2144M electrical characteristics at specified free-air temperature, $V_{CC\pm} = \pm 15\text{ V}$ (unless otherwise noted)

PARAMETER	TEST CONDITIONS	T_A †	TLE2144M			TLE2144AM			UNIT
			MIN	TYP	MAX	MIN	TYP	MAX	
V_{IO} Input offset voltage	$V_{IC} = 0, R_S = 50\ \Omega$	25°C	0.6	2.4		0.5	1.5	mV	
		Full range			4		3.2		
α_{VIO} Temperature coefficient of input offset voltage		Full range	1.7			1.7		$\mu\text{V}/^\circ\text{C}$	
I_{IO} Input offset current		25°C	7	100		7	100	nA	
		Full range			250		250		
I_{IB} Input bias current		25°C	-0.7	-1.5		-0.7	-1.5	μA	
	Full range			-1.8		-1.8			
V_{ICR} Common-mode input voltage range	$R_S = 50\ \Omega$	25°C	-15 to 13	-15.3 to 13.2		-15 to 13	-15.3 to 13.2	V	
		Full range	-15 to 12.7	-15.3 to 12.9		-15 to 12.7	-15.3 to 12.9		
V_{OM+} Maximum positive peak output voltage swing	$I_O = -150\ \mu\text{A}$ $I_O = -1.5\ \text{mA}$ $I_O = -15\ \text{mA}$ $I_O = -100\ \mu\text{A}$ $I_O = -1\ \text{mA}$ $I_O = -10\ \text{mA}$	25°C	13.8	14.1		13.8	14.1	V	
			13.7	14		13.7	14		
			13.1	13.7		13.1	13.7		
		Full range	13.7			13.7			
			13.6			13.6			
			13.1			13.1			
V_{OM-} Maximum negative peak output voltage swing	$I_O = 150\ \mu\text{A}$ $I_O = 1.5\ \text{mA}$ $I_O = 15\ \text{mA}$ $I_O = 100\ \mu\text{A}$ $I_O = 1\ \text{mA}$ $I_O = 10\ \text{mA}$	25°C	-14.7	-14.9		-14.7	-14.9	V	
			-14.5	-14.8		-14.5	-14.8		
			-13.4	-13.8		-13.4	-13.8		
		Full range	-14.6			-14.6			
			-14.5			-14.5			
			-13.4			-13.4			
AVD Large-signal differential voltage amplification	$V_O = \pm 10\ \text{V}, R_L = 2\ \text{k}\Omega$	25°C	100	170		100	170	V/mV	
		Full range	20			20			
r_i Input resistance		25°C	65			65	$\text{M}\Omega$		
c_i Input capacitance		25°C	2.5			2.5	pF		
z_o Open-loop output impedance	$f = 1\ \text{MHz}$	25°C	30			30	Ω		
CMRR Common-mode rejection ratio	$V_{IC} = V_{ICRmin}, R_S = 50\ \Omega$	25°C	85	108		85	108	dB	
		Full range	80			80			
k_{SVR} Supply-voltage rejection ratio ($\Delta V_{CC\pm} / \Delta V_{IO}$)	$V_{CC\pm} = \pm 2.5\ \text{V to } \pm 15\ \text{V}, R_S = 50\ \Omega$	25°C	90	106		90	106	dB	
		Full range	85			85			
I_{OS} Short-circuit output current	$V_O = 0$	25°C	$V_{ID} = 1\ \text{V}$	-25	-50		-25	-50	mA
			$V_{ID} = -1\ \text{V}$	20	31		20	31	
I_{CC} Supply current	$V_O = 0, V_{IC} = 2.5\ \text{V}$	No load,	25°C	13.8	18		13.8	18	mA
			Full range			18.8		18.8	

† Full range is -55°C to 125°C



TLE214x, TLE214xA
EXCALIBUR LOW-NOISE HIGH-SPEED
PRECISION OPERATIONAL AMPLIFIERS

SLOS183C – FEBRUARY 1997 – REVISED JUNE 2006

TLE2144M operating characteristics, $V_{CC\pm} = \pm 15\text{ V}$, $T_A = 25^\circ\text{C}$

PARAMETER		TEST CONDITIONS		TLE2144M			TLE2144AM			UNIT
				MIN	TYP	MAX	MIN	TYP	MAX	
SR+	Positive slew rate	$R_L = 2\text{ k}\Omega$, $C_L = 100\text{ pF}$	$A_{VD} = -1$,	27	45		27	45	$\text{V}/\mu\text{s}$	
SR-	Negative slew rate			27	42		27	42		
t_s	Settling time	$A_{VD} = -1$, 10-V step	To 0.1%	0.34			0.34			μs
				.4			.4			
V_n	Equivalent input noise voltage	$R_S = 20\ \Omega$,	$f = 10\text{ Hz}$	15			15			$\text{nV}/\sqrt{\text{Hz}}$
			$f = 1\text{ kHz}$	10.5			10.5			
$V_{N(PP)}$	Peak-to-peak equivalent input noise voltage	$f = 0.1\text{ Hz to }1\text{ Hz}$		0.48			0.48			μV
		$f = 0.1\text{ Hz to }10\text{ Hz}$		0.51			0.51			
I_n	Equivalent input noise current	$f = 10\text{ Hz}$		1.89			1.89			$\text{pA}/\sqrt{\text{Hz}}$
		$f = 10\text{ kHz}$		0.47			0.47			
THD + N	Total harmonic distortion plus noise	$V_{O(PP)} = 20\text{ V}$, $A_{VD} = 10$,	$R_L = 2\text{ k}\Omega$, $f = 10\text{ kHz}$	0.01%			0.01%			
B_1	Unity-gain bandwidth	$R_L = 2\text{ k}\Omega$,	$C_L = 100\text{ pF}$	6			6			MHz
	Gain-bandwidth product	$R_L = 2\text{ k}\Omega$, $f = 100\text{ kHz}$	$C_L = 100\text{ pF}$,	5.9			5.9			MHz
B_{OM}	Maximum output-swing bandwidth	$V_{O(PP)} = 20\text{ V}$, $A_{VD} = 1$,	$R_L = 2\text{ k}\Omega$, $C_L = 100\text{ pF}$	668			668			kHz
ϕ_m	Phase margin at unity gain	$R_L = 2\text{ k}\Omega$,	$C_L = 100\text{ pF}$	58°			58°			

TLE214x, TLE214xA
EXCALIBUR LOW-NOISE HIGH-SPEED
PRECISION OPERATIONAL AMPLIFIERS

SLOS183C – FEBRUARY 1997 – REVISED JUNE 2006

TLE2141Y electrical characteristics at specified free-air temperature, $V_{CC\pm} = \pm 15\text{ V}$, $T_A = 25^\circ\text{C}$ (unless otherwise noted)

PARAMETER	TEST CONDITIONS	TLE2141Y			UNIT
		MIN	TYP	MAX	
V_{IO} Input offset voltage	$V_{IC} = 0,$ $V_O = 0$ $R_S = 50\ \Omega,$	200	1000		μV
I_{IO} Input offset current		7	100		nA
I_{IB} Input bias current		-0.7	-1.5		μA
V_{ICR} Common-mode input voltage range	$R_S = 50\ \Omega$	-15 to 13	-15.3 to 13.2		V
V_{OM+} Maximum positive peak output voltage swing	$I_O = -150\ \mu\text{A}$	13.8	14.1		V
	$I_O = -1.5\ \text{mA}$	13.7	14		
	$I_O = -15\ \text{mA}$	13.3	13.7		
V_{OM-} Maximum negative peak output voltage swing	$I_O = 150\ \mu\text{A}$	-14.7	-14.9		V
	$I_O = 1.5\ \text{mA}$	-14.5	-14.8		
	$I_O = 15\ \text{mA}$	-13.4	-13.8		
A_{VD} Large-signal differential voltage amplification	$V_O = \pm 10\ \text{V},$ $R_L = 2\ \text{k}\Omega$	100	450		V/mV
r_i Input resistance		65			$\text{M}\Omega$
c_i Input capacitance		2.5			pF
z_o Open-loop output impedance	$f = 1\ \text{MHz}$	30			Ω
CMRR Common-mode rejection ratio	$V_{IC} = V_{ICRmin},$ $R_S = 50\ \Omega$	80	108		dB
k_{SVR} Supply-voltage rejection ratio ($\Delta V_{CC\pm}/\Delta V_{IO}$)	$V_{CC\pm} = \pm 2.5\ \text{V to } \pm 15\ \text{V},$ $R_S = 50\ \Omega$	85	106		dB
I_{OS} Short-circuit output current	$V_O = 0$	$V_{ID} = 1\ \text{V}$	-25	-50	mA
		$V_{ID} = -1\ \text{V}$	20	31	
I_{CC} Supply current	$V_O = 0,$ No load	3.5	4.5		mA



TLE214x, TLE214xA
EXCALIBUR LOW-NOISE HIGH-SPEED
PRECISION OPERATIONAL AMPLIFIERS

SLOS183C – FEBRUARY 1997 – REVISED JUNE 2006

TLE2142Y electrical characteristics at specified free-air temperature, $V_{CC\pm} = \pm 15\text{ V}$, $T_A = 25^\circ\text{C}$

PARAMETER	TEST CONDITIONS	TLE2142Y			UNIT
		MIN	TYP	MAX	
V_{IO} Input offset voltage	$V_{IC} = 0$, $V_O = 0$, $R_S = 50\ \Omega$		150	875	μV
I_{IO} Input offset current			7	100	nA
I_{IB} Input bias current			-0.7	-1.5	μA
V_{ICR} Common-mode input voltage range	$R_S = 50\ \Omega$	-15 to 13	-15.3 to 13.2		V
V_{OM+} Maximum positive peak output voltage swing	$I_O = -150\ \mu\text{A}$	13.8	14.1		V
	$I_O = -1.5\ \text{mA}$	13.7	14		
	$I_O = -15\ \text{mA}$	13.3	13.7		
V_{OM-} Maximum negative peak output voltage swing	$I_O = 150\ \mu\text{A}$	-14.7	-14.9		V
	$I_O = 1.5\ \text{mA}$	-14.5	-14.8		
	$I_O = 15\ \text{mA}$	-13.4	-13.8		
A_{VD} Large-signal differential voltage amplification	$V_O = \pm 10\ \text{V}$, $R_L = 2\ \text{k}\Omega$	100	450		V/mV
r_i Input resistance			65		M Ω
c_i Input capacitance			2.5		pF
z_o Open-loop output impedance	$f = 1\ \text{MHz}$		30		Ω
CMRR Common-mode rejection ratio	$V_{IC} = V_{ICRmin}$, $R_S = 50\ \Omega$	80	108		dB
k_{SVR} Supply-voltage rejection ratio ($\Delta V_{CC\pm} / \Delta V_{IO}$)	$V_{CC\pm} = \pm 2.5\ \text{V}$ to $\pm 15\ \text{V}$, $R_S = 50\ \Omega$	85	106		dB
I_{OS} Short-circuit output current	$V_O = 0$	$V_{ID} = 1\ \text{V}$	-25	-50	mA
		$V_{ID} = -1\ \text{V}$	20	31	
I_{CC} Supply current	$V_O = 0$, No load		6.9	9	mA

TLE214x, TLE214xA EXCALIBUR LOW-NOISE HIGH-SPEED PRECISION OPERATIONAL AMPLIFIERS

SLOS183C – FEBRUARY 1997 – REVISED JUNE 2006

TLE2144Y electrical characteristics at $V_{CC\pm} = \pm 15\text{ V}$, $T_A = 25^\circ\text{C}$ (unless otherwise noted)

PARAMETER	TEST CONDITIONS	TLE2144Y			UNIT
		MIN	TYP	MAX	
V_{IO} Input offset voltage	$V_{IC} = 0$, $V_O = 0$ $R_S = 50\ \Omega$,		0.3	1.8	mV
I_{IO} Input offset current			7	100	nA
I_{IB} Input bias current			-0.7	-1.5	μA
V_{ICR} Common-mode input voltage range	$R_S = 50\ \Omega$	-15 to 13	-15.3 to 13.2		V
V_{OM+} Maximum positive peak output voltage swing	$I_O = -150\ \mu\text{A}$	13.8	14.1		V
	$I_O = -1.5\ \text{mA}$	13.7	14		
	$I_O = -15\ \text{mA}$	13.3	13.7		
V_{OM-} Maximum negative peak output voltage swing	$I_O = 150\ \mu\text{A}$	-14.7	-14.9		V
	$I_O = 1.5\ \text{mA}$	-14.5	-14.8		
	$I_O = 15\ \text{mA}$	-13.4	-13.8		
A_{VD} Large-signal differential voltage amplification	$V_O = \pm 10\ \text{V}$, $R_L = 2\ \text{k}\Omega$	100	450		V/mV
r_i Input resistance			65		$\text{M}\Omega$
c_i Input capacitance			2.5		pF
z_o Open-loop output impedance	$f = 1\ \text{MHz}$		30		Ω
CMRR Common-mode rejection ratio	$V_{IC} = V_{ICRmin}$, $R_S = 50\ \Omega$	80	108		dB
k_{SVR} Supply-voltage rejection ratio ($\Delta V_{CC\pm} / \Delta V_{IO}$)	$V_{CC\pm} = \pm 2.5\ \text{V}$ to $\pm 15\ \text{V}$, $R_S = 50\ \Omega$	85	106		dB
I_{OS} Short-circuit output current	$V_O = 0$	$V_{ID} = 1\ \text{V}$	-25	-50	mA
		$V_{ID} = -1\ \text{V}$	20	31	
I_{CC} Supply current	$V_O = 0$, No load		13.8	18	mA

TYPICAL CHARACTERISTICS

Table of Graphs

		FIGURE	
V_{IO}	Input offset voltage	Distribution	1, 2, 3
I_{IO}	Input offset current	vs Free-air temperature	4
I_{IB}	Input bias current	vs Common-mode input voltage	5
		vs Free-air temperature	6
V_{OM+}	Maximum positive peak output voltage	vs Supply voltage	7
		vs Free-air temperature	8
		vs Output current	9
		vs Settling time	11
V_{OM-}	Maximum negative peak output voltage	vs Supply voltage	7
		vs Free-air temperature	8
		vs Output current	10
		vs Settling time	11
$V_{O(PP)}$	Maximum peak-to-peak output voltage	vs Frequency	12
V_{OH}	High-level output voltage	vs Output current	13
V_{OL}	Low-level output voltage	vs Output current	14
A_{VD}	Large-signal differential voltage amplification	vs Frequency	15
		vs Free-air temperature	16
z_o	Closed-loop output impedance	vs Frequency	17
I_{OS}	Short-circuit output current	vs Free-air temperature	18
CMRR	Common-mode rejection ratio	vs Frequency	19
		vs Free-air temperature	20
k_{SVR}	Supply-voltage rejection ratio	vs Frequency	21
		vs Free-air temperature	22
I_{CC}	Supply current	vs Supply voltage	23
		vs Free-air temperature	24
V_n	Equivalent input noise voltage	vs Frequency	25
V_n	Input noise voltage	Over a 10-second period	26
I_n	Noise current	vs Frequency	27
THD + N	Total harmonic distortion plus noise	vs Frequency	28
SR	Slew rate	vs Free-air temperature	29
		vs Load capacitance	30
Pulse response	Noninverting large signal	vs Time	31
	Inverting large signal	vs Time	32
	Small signal	vs Time	33
B_1	Unity-gain bandwidth	vs Load capacitance	34
	Gain margin	vs Load capacitance	35
ϕ_m	Phase margin	vs Load capacitance	36
	Phase shift	vs Frequency	15

TLE214x, TLE214xA EXCALIBUR LOW-NOISE HIGH-SPEED PRECISION OPERATIONAL AMPLIFIERS

SLOS183C – FEBRUARY 1997 – REVISED JUNE 2006

TYPICAL CHARACTERISTICS

**TLE2141
DISTRIBUTION OF
INPUT OFFSET VOLTAGE**

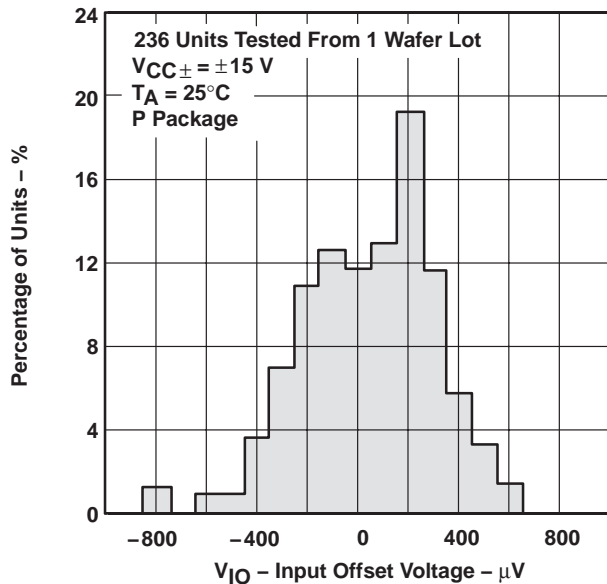

Figure 1

**TLE2142
DISTRIBUTION OF
INPUT OFFSET VOLTAGE**

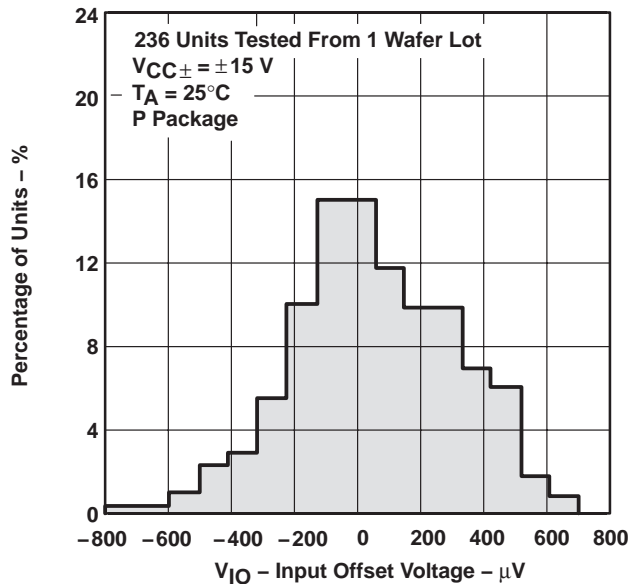

Figure 2

**TLE2144
DISTRIBUTION OF
INPUT OFFSET VOLTAGE**

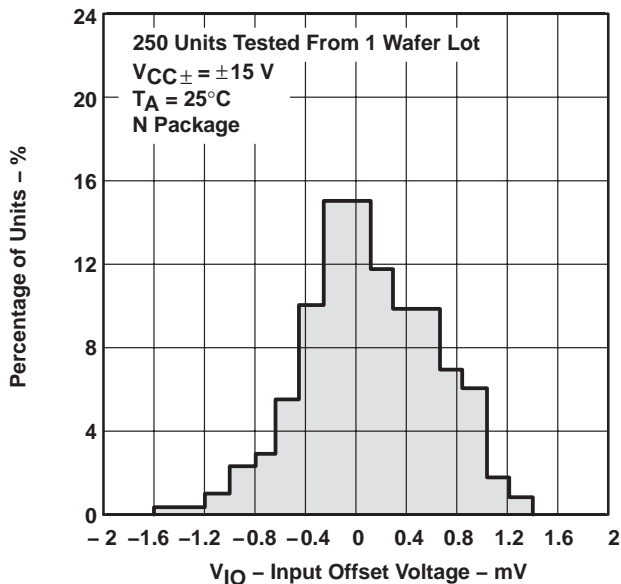

Figure 3

**INPUT OFFSET CURRENT†
VS
FREE-AIR TEMPERATURE**

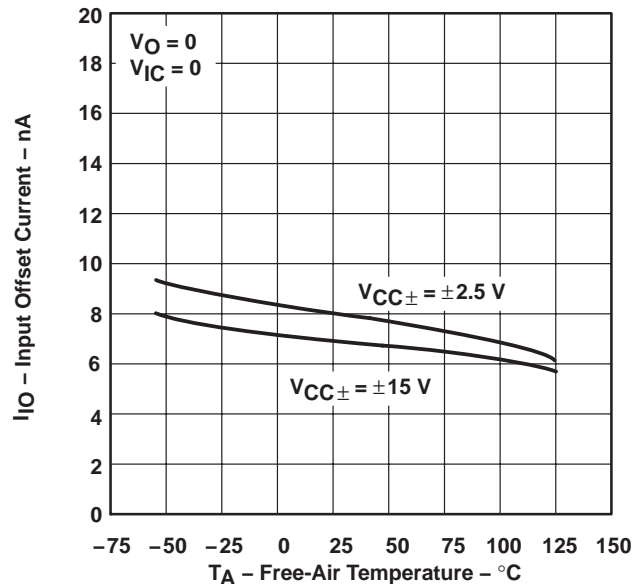
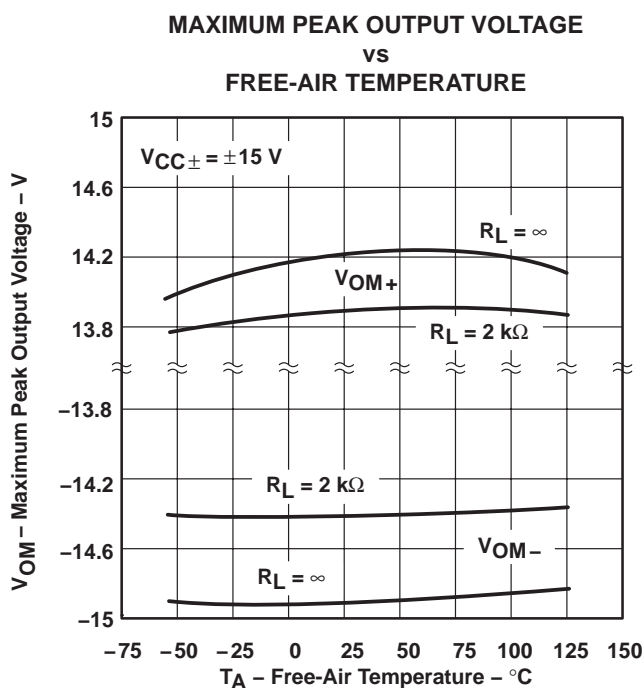
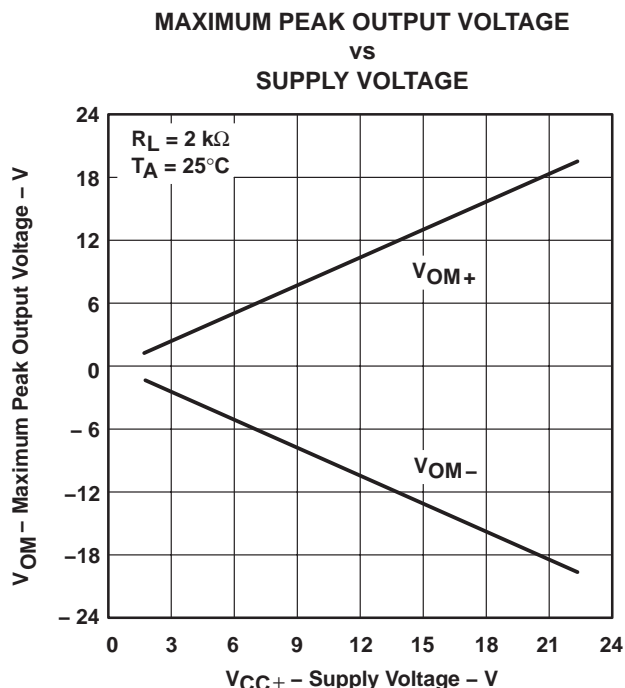
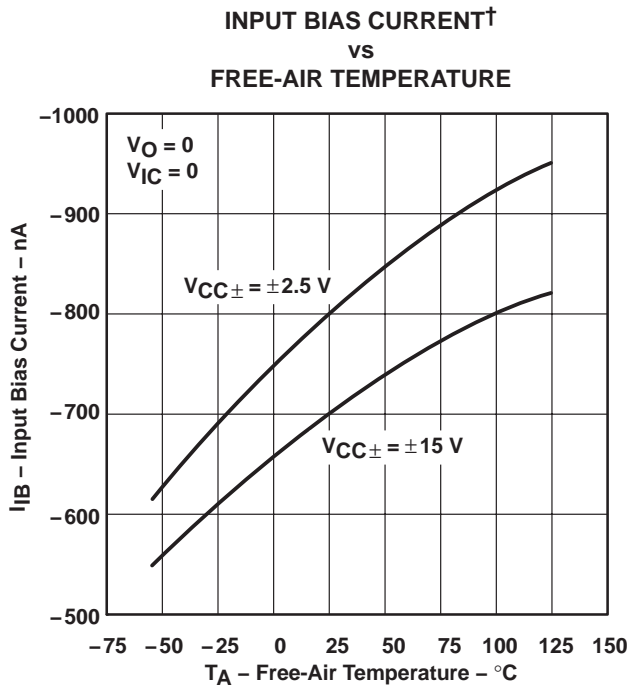
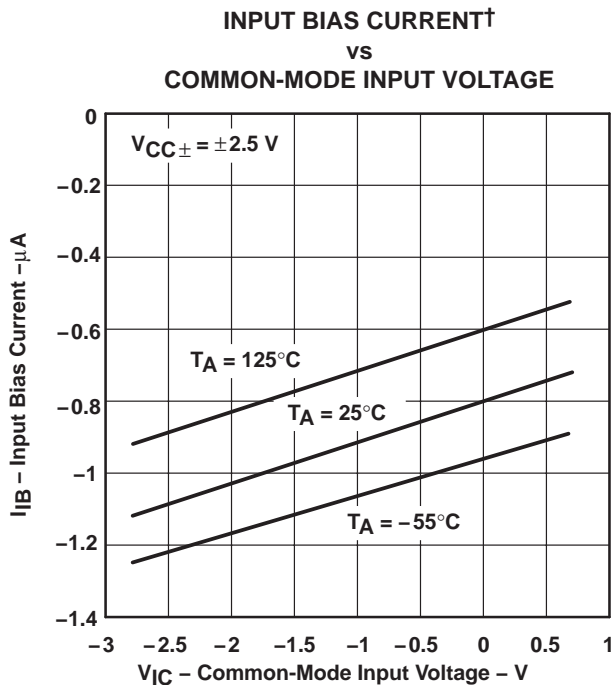

Figure 4

† Data at high and low temperatures are applicable only within the rated operating free-air temperature ranges of the various devices.

TYPICAL CHARACTERISTICS



† Data at high and low temperatures are applicable only within the rated operating free-air temperature ranges of the various devices.

TLE214x, TLE214xA EXCALIBUR LOW-NOISE HIGH-SPEED PRECISION OPERATIONAL AMPLIFIERS

SLOS183C – FEBRUARY 1997 – REVISED JUNE 2006

TYPICAL CHARACTERISTICS

MAXIMUM POSITIVE PEAK
OUTPUT VOLTAGE†
vs
OUTPUT CURRENT

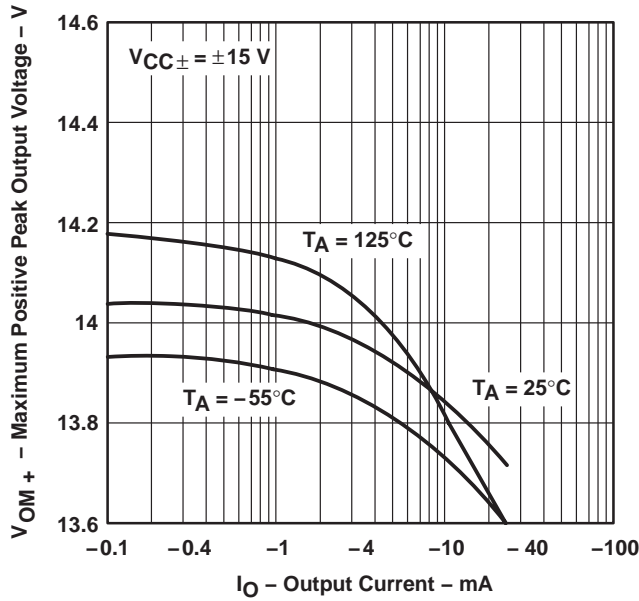

Figure 9

MAXIMUM NEGATIVE PEAK
OUTPUT VOLTAGE†
vs
OUTPUT CURRENT

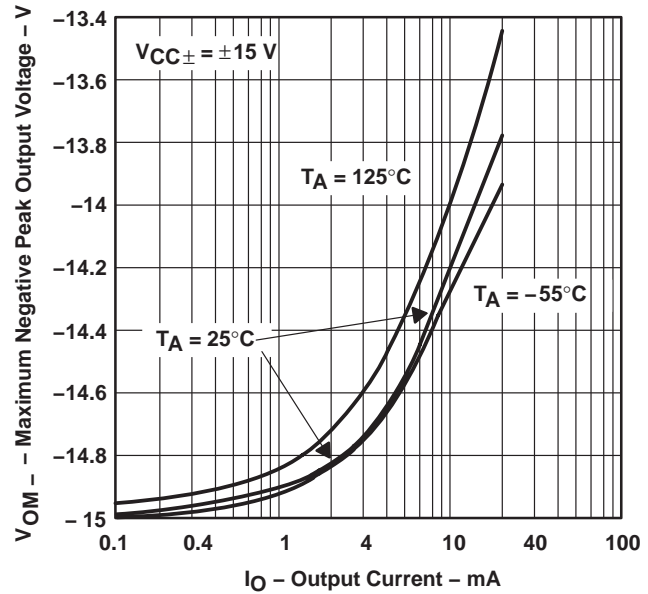

Figure 10

MAXIMUM PEAK OUTPUT VOLTAGE
vs
SETTLING TIME

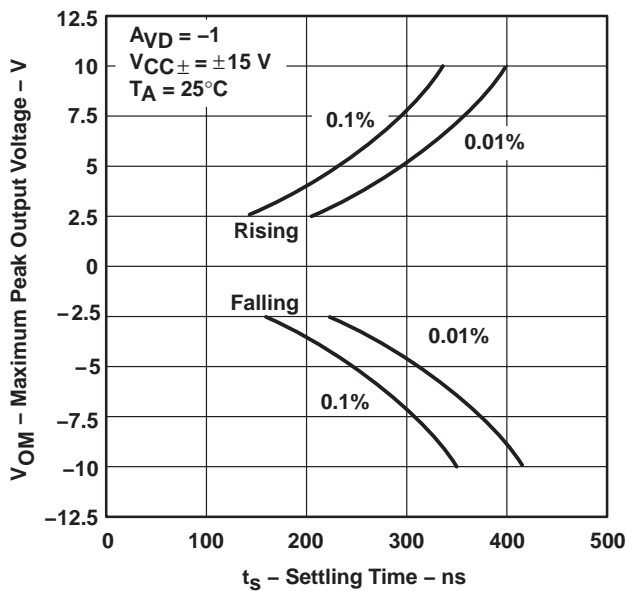

Figure 11

MAXIMUM PEAK-TO-PEAK
OUTPUT VOLTAGE†
vs
FREQUENCY

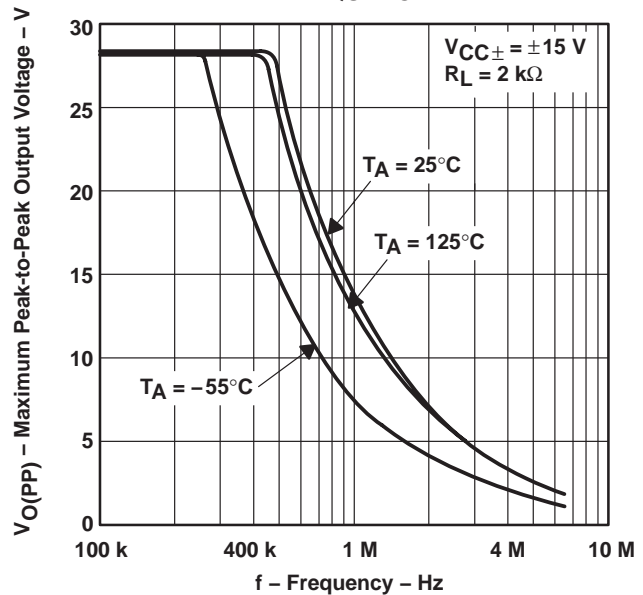

Figure 12

† Data at high and low temperatures are applicable only within the rated operating free-air temperature ranges of the various devices.

TYPICAL CHARACTERISTICS

**HIGH-LEVEL OUTPUT VOLTAGE†
 vs
 OUTPUT CURRENT**

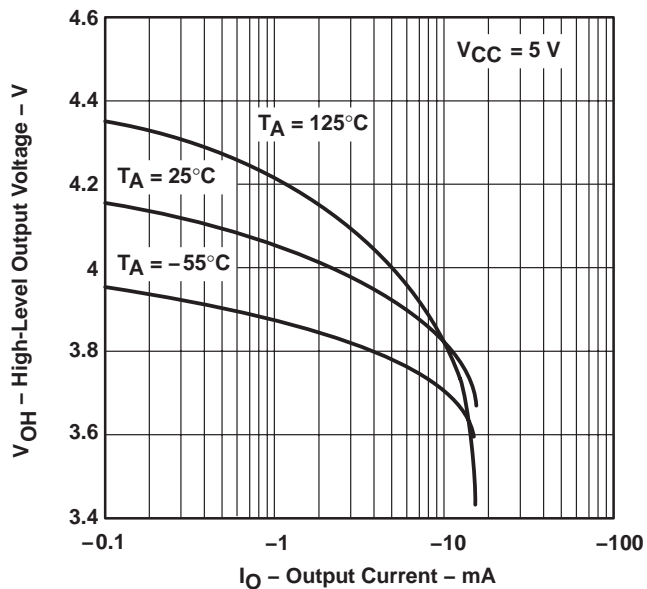

Figure 13

**LOW-LEVEL OUTPUT VOLTAGE†
 vs
 OUTPUT CURRENT**

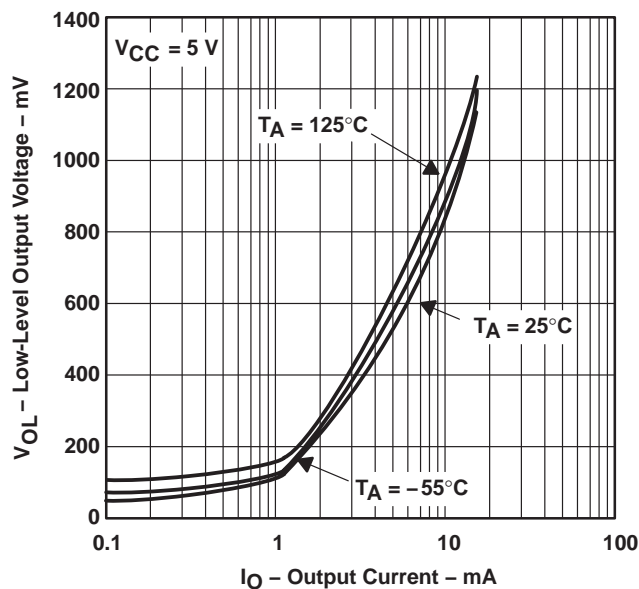

Figure 14

**LARGE-SIGNAL DIFFERENTIAL VOLTAGE
 AMPLIFICATION AND PHASE SHIFT
 vs
 FREQUENCY**

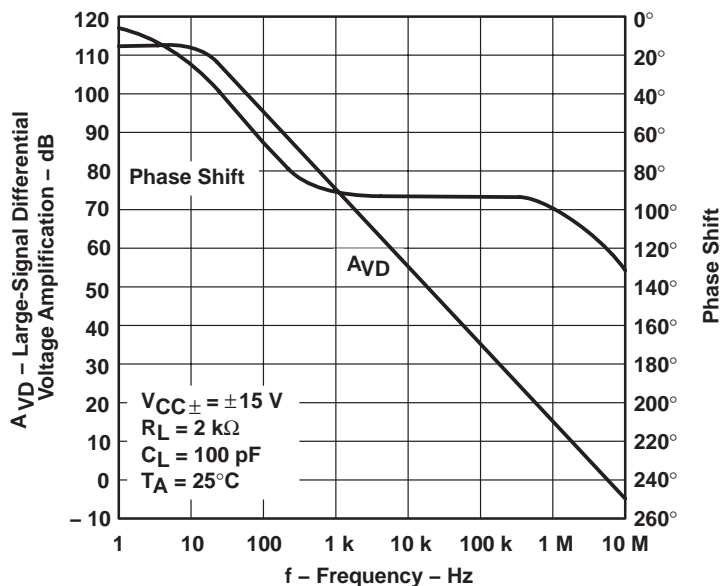

Figure 15

† Data at high and low temperatures are applicable only within the rated operating free-air temperature ranges of the various devices.

TLE214x, TLE214xA
EXCALIBUR LOW-NOISE HIGH-SPEED
PRECISION OPERATIONAL AMPLIFIERS

SLOS183C – FEBRUARY 1997 – REVISED JUNE 2006

TYPICAL CHARACTERISTICS

LARGE-SIGNAL DIFFERENTIAL VOLTAGE AMPLIFICATION†

vs

FREE-AIR TEMPERATURE

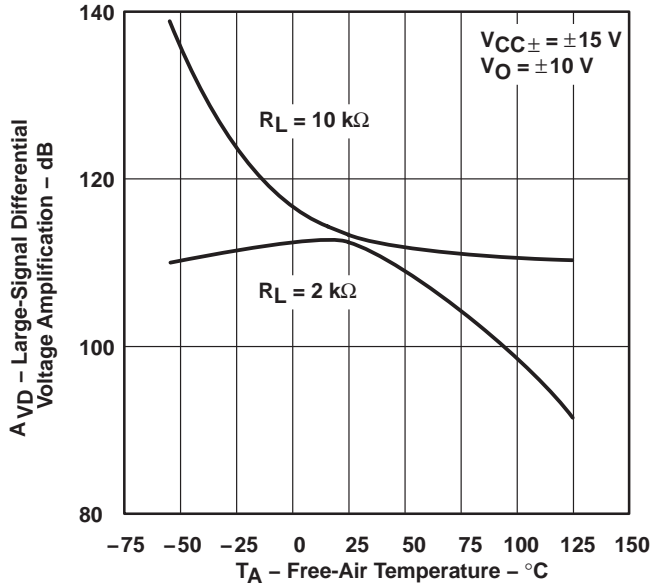

Figure 16

CLOSED-LOOP OUTPUT IMPEDANCE

vs

FREQUENCY

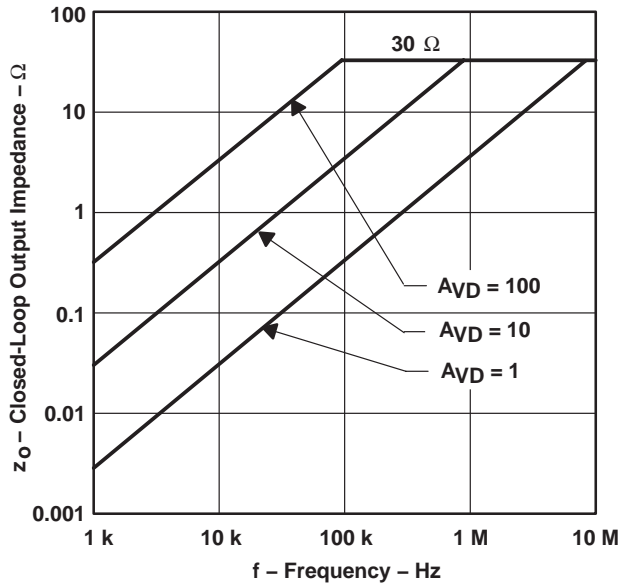

Figure 17

SHORT-CIRCUIT OUTPUT CURRENT†

vs

FREE-AIR TEMPERATURE

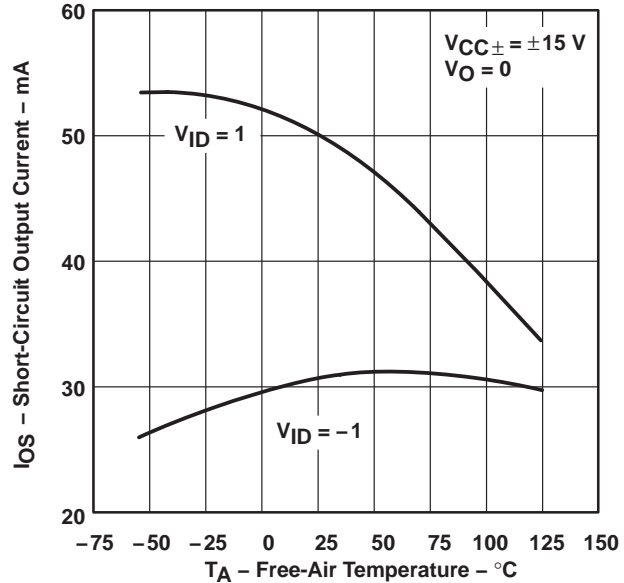

Figure 18

† Data at high and low temperatures are applicable only within the rated operating free-air temperature ranges of the various devices.



TYPICAL CHARACTERISTICS

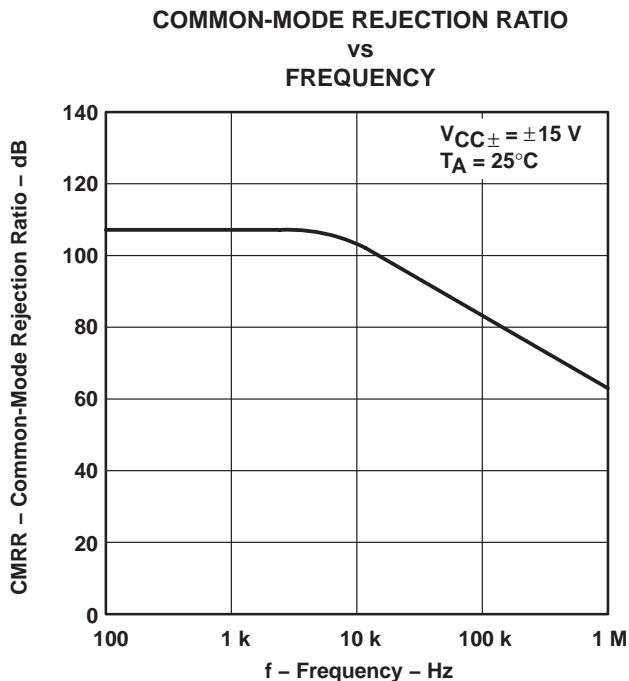

Figure 19

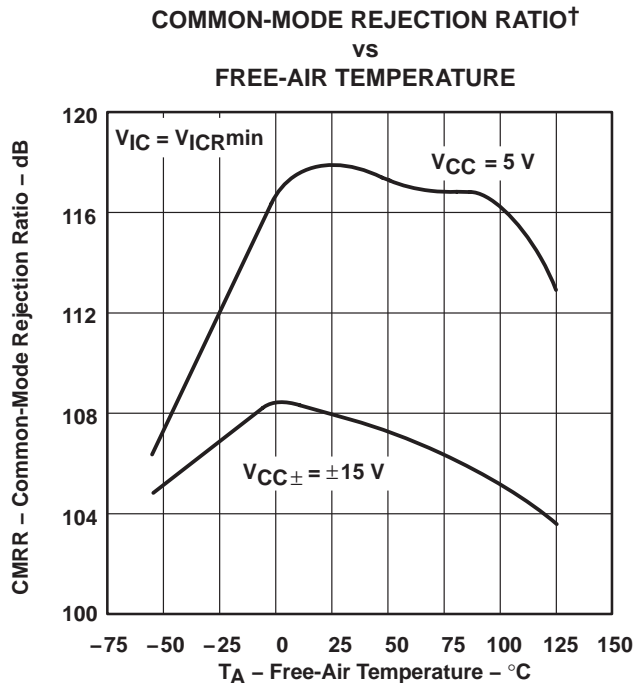

Figure 20

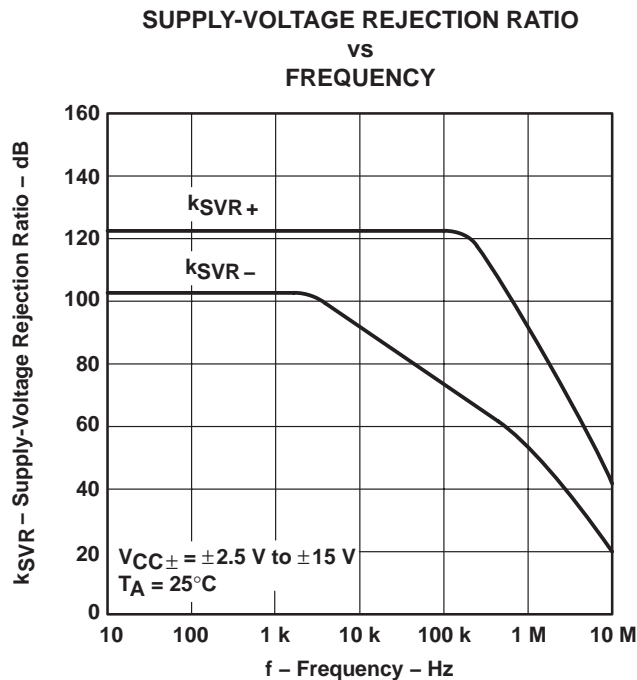

Figure 21

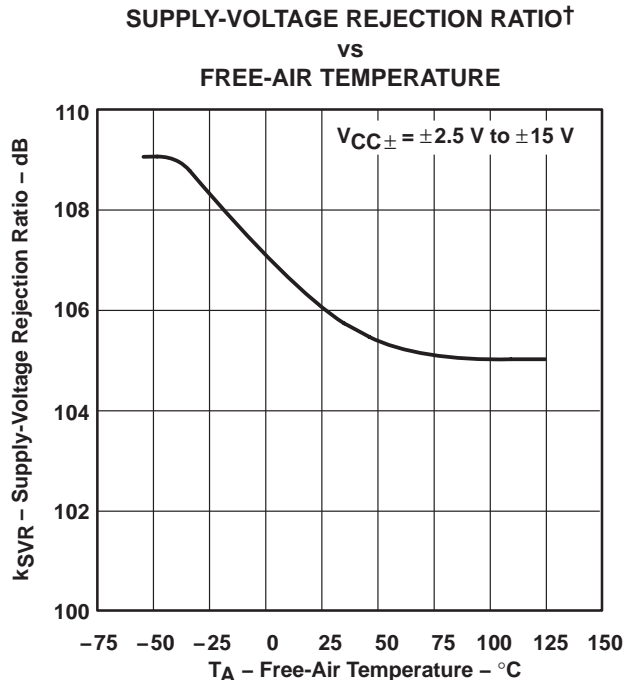

Figure 22

† Data at high and low temperatures are applicable only within the rated operating free-air temperature ranges of the various devices.

TLE214x, TLE214xA
EXCALIBUR LOW-NOISE HIGH-SPEED
PRECISION OPERATIONAL AMPLIFIERS

SLOS183C – FEBRUARY 1997 – REVISED JUNE 2006

TYPICAL CHARACTERISTICS

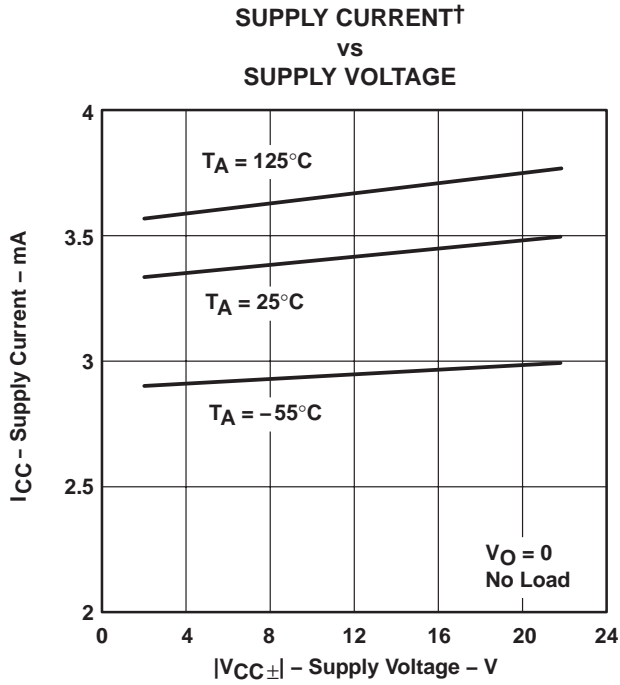

Figure 23

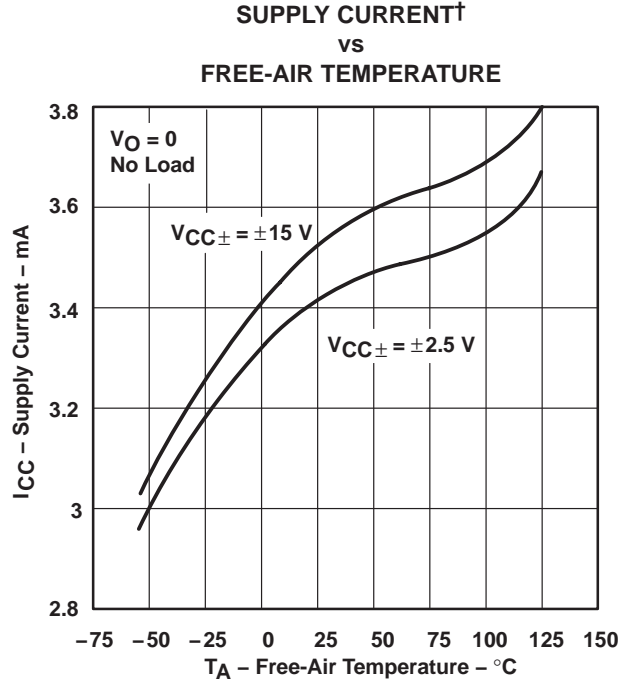

Figure 24

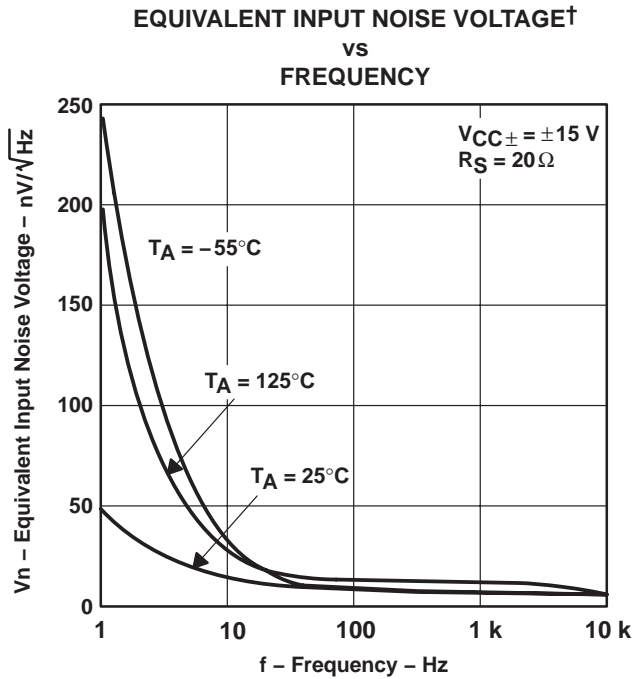

Figure 25

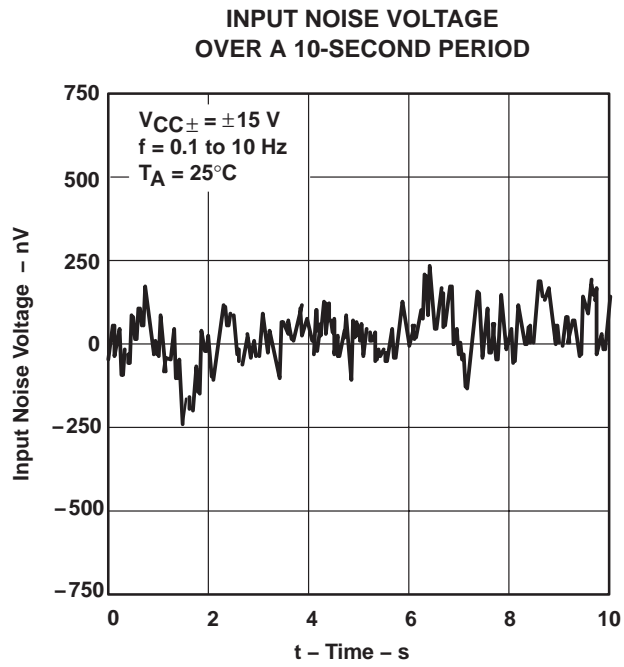

Figure 26

† Data at high and low temperatures are applicable only within the rated operating free-air temperature ranges of the various devices.



TYPICAL CHARACTERISTICS

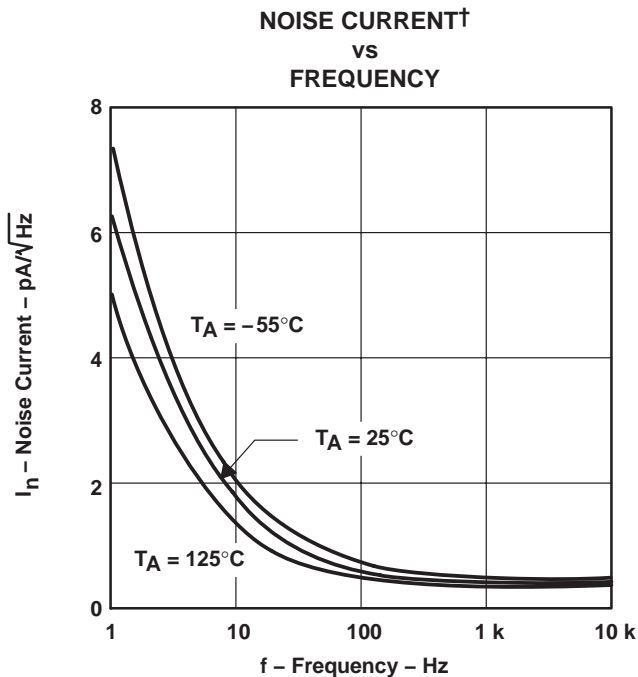

Figure 27

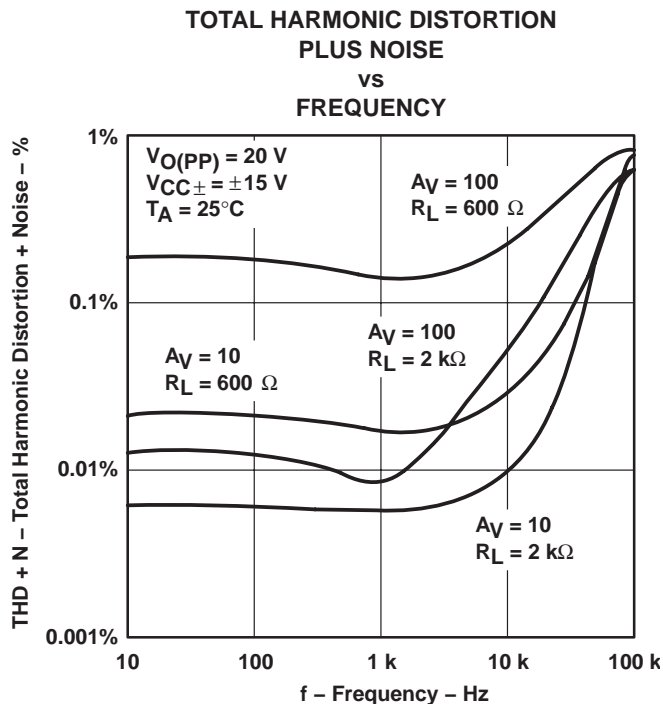

Figure 28

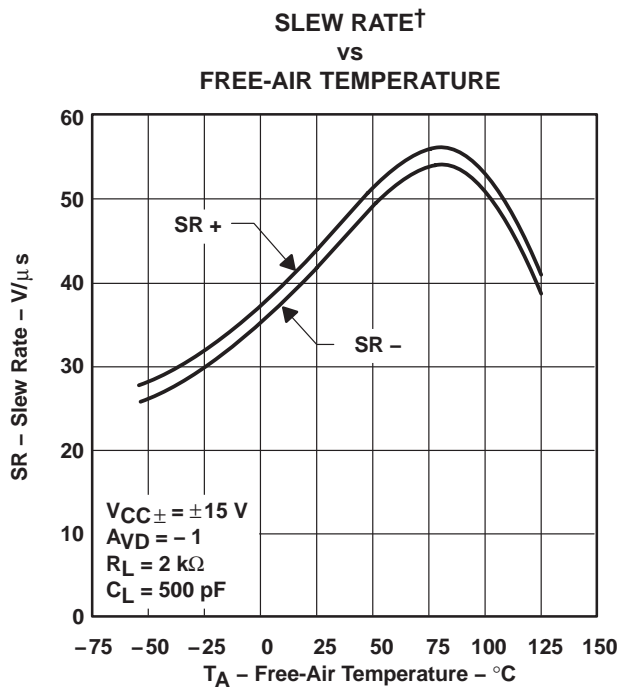

Figure 29

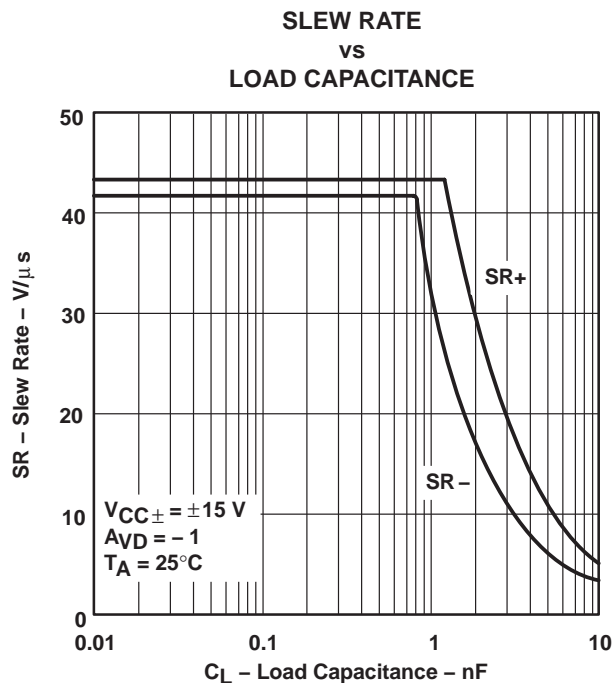

Figure 30

† Data at high and low temperatures are applicable only within the rated operating free-air temperature ranges of the various devices.

TLE214x, TLE214xA
EXCALIBUR LOW-NOISE HIGH-SPEED
PRECISION OPERATIONAL AMPLIFIERS

SLOS183C – FEBRUARY 1997 – REVISED JUNE 2006

TYPICAL CHARACTERISTICS

**NONINVERTING
 LARGE-SIGNAL
 PULSE RESPONSE†**

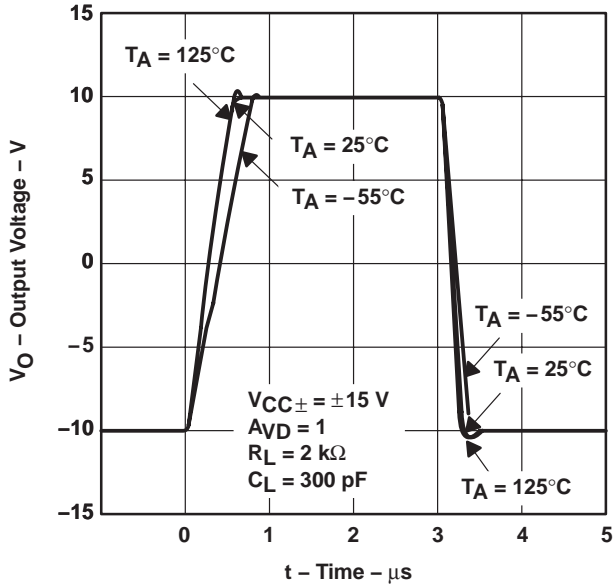

Figure 31

**INVERTING
 LARGE-SIGNAL
 PULSE RESPONSE†**

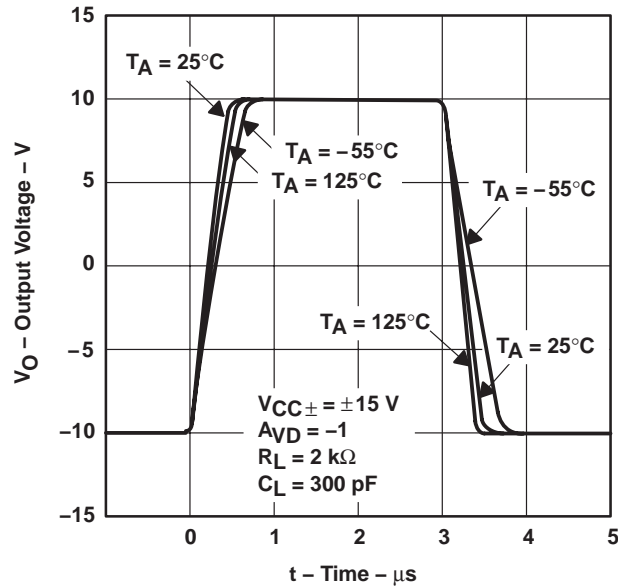

Figure 32

**SMALL-SIGNAL
 PULSE RESPONSE**

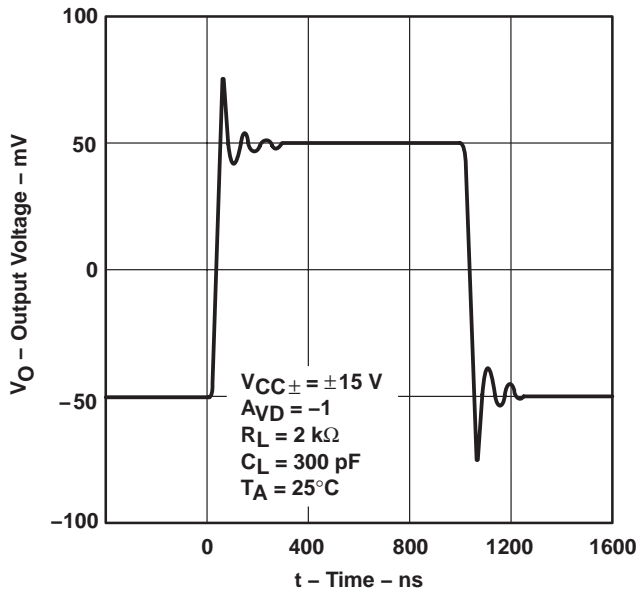

Figure 33

**UNITY-GAIN BANDWIDTH†
 vs
 LOAD CAPACITANCE**

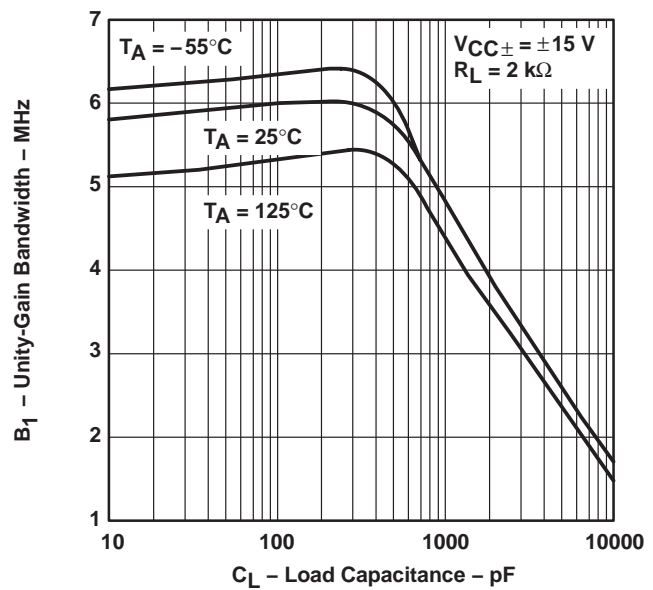

Figure 34

† Data at high and low temperatures are applicable only within the rated operating free-air temperature ranges of the various devices.

TYPICAL CHARACTERISTICS

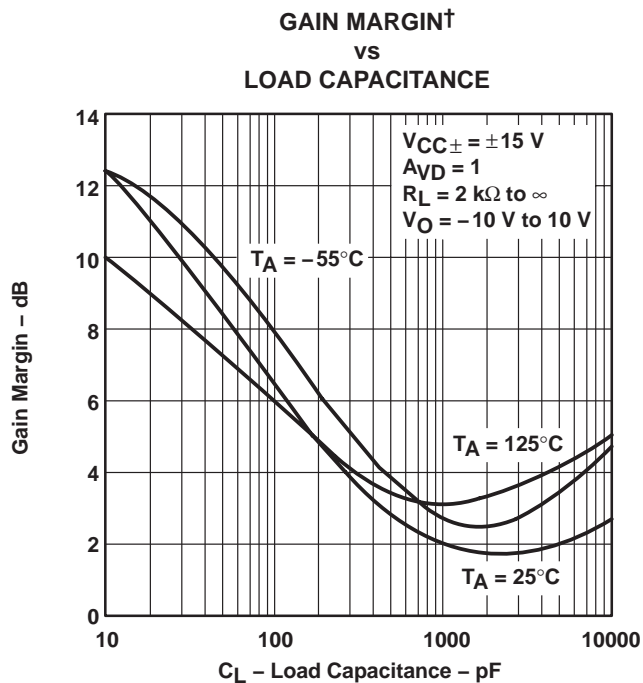

Figure 35

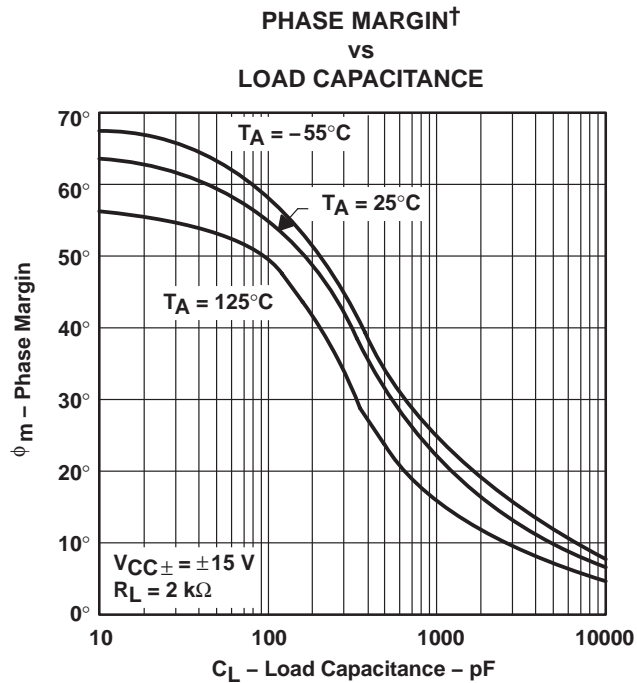

Figure 36

† Data at high and low temperatures are applicable only within the rated operating free-air temperature ranges of the various devices.

TLE214x, TLE214xA EXCALIBUR LOW-NOISE HIGH-SPEED PRECISION OPERATIONAL AMPLIFIERS

SLOS183C – FEBRUARY 1997 – REVISED JUNE 2006

APPLICATION INFORMATION

input offset voltage nulling

The TLE2141 series offers external null pins that can be used to further reduce the input offset voltage. If this feature is desired, connect the circuit of Figure 37 as shown. If external nulling is not needed, the null pins may be left unconnected.

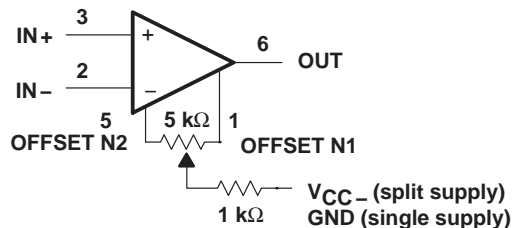

Figure 37. Input Offset Voltage Null Circuit

PACKAGING INFORMATION

Orderable Device	Status ⁽¹⁾	Package Type	Package Drawing	Pins	Package Qty	Eco Plan ⁽²⁾	Lead/Ball Finish	MSL Peak Temp ⁽³⁾
5962-9321603Q2A	ACTIVE	LCCC	FK	20	1	TBD	POST-PLATE	N / A for Pkg Type
5962-9321603QHA	ACTIVE	CFP	U	10	1	TBD	A42 SNPB	N / A for Pkg Type
5962-9321603QPA	ACTIVE	CDIP	JG	8	1	TBD	A42 SNPB	N / A for Pkg Type
5962-9321604Q2A	ACTIVE	LCCC	FK	20	1	TBD	POST-PLATE	N / A for Pkg Type
5962-9321604QHA	ACTIVE	CFP	U	10	1	TBD	A42 SNPB	N / A for Pkg Type
5962-9321604QPA	ACTIVE	CDIP	JG	8	1	TBD	A42 SNPB	N / A for Pkg Type
5962-9321605Q2A	ACTIVE	LCCC	FK	20	1	TBD	POST-PLATE	N / A for Pkg Type
5962-9321605QCA	ACTIVE	CDIP	J	14	1	TBD	A42 SNPB	N / A for Pkg Type
5962-9321606Q2A	ACTIVE	LCCC	FK	20	1	TBD	POST-PLATE	N / A for Pkg Type
5962-9321606QCA	ACTIVE	CDIP	J	14	1	TBD	A42 SNPB	N / A for Pkg Type
TLE2141ACD	ACTIVE	SOIC	D	8	75	Green (RoHS & no Sb/Br)	CU NIPDAU	Level-1-260C-UNLIM
TLE2141ACDG4	ACTIVE	SOIC	D	8	75	Green (RoHS & no Sb/Br)	CU NIPDAU	Level-1-260C-UNLIM
TLE2141ACP	ACTIVE	PDIP	P	8	50	Pb-Free (RoHS)	CU NIPDAU	N / A for Pkg Type
TLE2141ACPE4	ACTIVE	PDIP	P	8	50	Pb-Free (RoHS)	CU NIPDAU	N / A for Pkg Type
TLE2141AID	ACTIVE	SOIC	D	8	75	Green (RoHS & no Sb/Br)	CU NIPDAU	Level-1-260C-UNLIM
TLE2141AIDG4	ACTIVE	SOIC	D	8	75	Green (RoHS & no Sb/Br)	CU NIPDAU	Level-1-260C-UNLIM
TLE2141AIDR	ACTIVE	SOIC	D	8	2500	Green (RoHS & no Sb/Br)	CU NIPDAU	Level-1-260C-UNLIM
TLE2141AIDRG4	ACTIVE	SOIC	D	8	2500	Green (RoHS & no Sb/Br)	CU NIPDAU	Level-1-260C-UNLIM
TLE2141AIP	ACTIVE	PDIP	P	8	50	Pb-Free (RoHS)	CU NIPDAU	N / A for Pkg Type
TLE2141AIPE4	ACTIVE	PDIP	P	8	50	Pb-Free (RoHS)	CU NIPDAU	N / A for Pkg Type
TLE2141CD	ACTIVE	SOIC	D	8	75	Green (RoHS & no Sb/Br)	CU NIPDAU	Level-1-260C-UNLIM
TLE2141CDG4	ACTIVE	SOIC	D	8	75	Green (RoHS & no Sb/Br)	CU NIPDAU	Level-1-260C-UNLIM
TLE2141CDR	ACTIVE	SOIC	D	8	2500	Green (RoHS & no Sb/Br)	CU NIPDAU	Level-1-260C-UNLIM
TLE2141CDRG4	ACTIVE	SOIC	D	8	2500	Green (RoHS & no Sb/Br)	CU NIPDAU	Level-1-260C-UNLIM
TLE2141CP	ACTIVE	PDIP	P	8	50	Pb-Free (RoHS)	CU NIPDAU	N / A for Pkg Type
TLE2141CPE4	ACTIVE	PDIP	P	8	50	Pb-Free (RoHS)	CU NIPDAU	N / A for Pkg Type
TLE2141ID	ACTIVE	SOIC	D	8	75	Green (RoHS & no Sb/Br)	CU NIPDAU	Level-1-260C-UNLIM
TLE2141IDG4	ACTIVE	SOIC	D	8	75	Green (RoHS & no Sb/Br)	CU NIPDAU	Level-1-260C-UNLIM
TLE2141IDR	ACTIVE	SOIC	D	8	2500	Green (RoHS & no Sb/Br)	CU NIPDAU	Level-1-260C-UNLIM

Orderable Device	Status ⁽¹⁾	Package Type	Package Drawing	Pins	Package Qty	Eco Plan ⁽²⁾	Lead/Ball Finish	MSL Peak Temp ⁽³⁾
TLE2141IDRG4	ACTIVE	SOIC	D	8	2500	Green (RoHS & no Sb/Br)	CU NIPDAU	Level-1-260C-UNLIM
TLE2141IP	ACTIVE	PDIP	P	8	50	Pb-Free (RoHS)	CU NIPDAU	N / A for Pkg Type
TLE2141IPE4	ACTIVE	PDIP	P	8	50	Pb-Free (RoHS)	CU NIPDAU	N / A for Pkg Type
TLE2141MD	ACTIVE	SOIC	D	8	75	TBD	CU NIPDAU	Level-1-220C-UNLIM
TLE2141MDR	ACTIVE	SOIC	D	8	2500	TBD	CU NIPDAU	Level-1-220C-UNLIM
TLE2142ACD	ACTIVE	SOIC	D	8	75	Green (RoHS & no Sb/Br)	CU NIPDAU	Level-1-260C-UNLIM
TLE2142ACDG4	ACTIVE	SOIC	D	8	75	Green (RoHS & no Sb/Br)	CU NIPDAU	Level-1-260C-UNLIM
TLE2142ACDR	ACTIVE	SOIC	D	8	2500	Green (RoHS & no Sb/Br)	CU NIPDAU	Level-1-260C-UNLIM
TLE2142ACDRG4	ACTIVE	SOIC	D	8	2500	Green (RoHS & no Sb/Br)	CU NIPDAU	Level-1-260C-UNLIM
TLE2142ACP	OBSOLETE	PDIP	P	8		TBD	Call TI	Call TI
TLE2142AID	ACTIVE	SOIC	D	8	75	Green (RoHS & no Sb/Br)	CU NIPDAU	Level-1-260C-UNLIM
TLE2142AIDG4	ACTIVE	SOIC	D	8	75	Green (RoHS & no Sb/Br)	CU NIPDAU	Level-1-260C-UNLIM
TLE2142AIDR	ACTIVE	SOIC	D	8	2500	Green (RoHS & no Sb/Br)	CU NIPDAU	Level-1-260C-UNLIM
TLE2142AIDRG4	ACTIVE	SOIC	D	8	2500	Green (RoHS & no Sb/Br)	CU NIPDAU	Level-1-260C-UNLIM
TLE2142AIP	OBSOLETE	PDIP	P	8		TBD	Call TI	Call TI
TLE2142AMD	ACTIVE	SOIC	D	8	75	TBD	CU NIPDAU	Level-1-220C-UNLIM
TLE2142AMDG4	ACTIVE	SOIC	D	8	75	Green (RoHS & no Sb/Br)	CU NIPDAU	Level-1-260C-UNLIM
TLE2142AMDR	ACTIVE	SOIC	D	8	2500	TBD	CU NIPDAU	Level-1-220C-UNLIM
TLE2142AMDRG4	ACTIVE	SOIC	D	8	2500	Green (RoHS & no Sb/Br)	CU NIPDAU	Level-1-260C-UNLIM
TLE2142AMFKB	ACTIVE	LCCC	FK	20	1	TBD	POST-PLATE	N / A for Pkg Type
TLE2142AMJGB	ACTIVE	CDIP	JG	8	1	TBD	A42 SNPB	N / A for Pkg Type
TLE2142AMUB	ACTIVE	CFP	U	10	1	TBD	A42 SNPB	N / A for Pkg Type
TLE2142CD	ACTIVE	SOIC	D	8	75	Green (RoHS & no Sb/Br)	CU NIPDAU	Level-1-260C-UNLIM
TLE2142CDG4	ACTIVE	SOIC	D	8	75	Green (RoHS & no Sb/Br)	CU NIPDAU	Level-1-260C-UNLIM
TLE2142CDR	ACTIVE	SOIC	D	8	2500	Green (RoHS & no Sb/Br)	CU NIPDAU	Level-1-260C-UNLIM
TLE2142CDRG4	ACTIVE	SOIC	D	8	2500	Green (RoHS & no Sb/Br)	CU NIPDAU	Level-1-260C-UNLIM
TLE2142CP	ACTIVE	PDIP	P	8	50	Pb-Free (RoHS)	CU NIPDAU	N / A for Pkg Type
TLE2142CPE4	ACTIVE	PDIP	P	8	50	Pb-Free (RoHS)	CU NIPDAU	N / A for Pkg Type
TLE2142CPWG4	ACTIVE	TSSOP	PW	16		TBD	Call TI	Call TI
TLE2142CPWLE	OBSOLETE	TSSOP	PW	16		TBD	Call TI	Call TI

Orderable Device	Status ⁽¹⁾	Package Type	Package Drawing	Pins	Package Qty	Eco Plan ⁽²⁾	Lead/Ball Finish	MSL Peak Temp ⁽³⁾
TLE2142CPWR	ACTIVE	TSSOP	PW	16	2000	Green (RoHS & no Sb/Br)	CU NIPDAU	Level-1-260C-UNLIM
TLE2142CPWRG4	ACTIVE	TSSOP	PW	16	2000	Green (RoHS & no Sb/Br)	CU NIPDAU	Level-1-260C-UNLIM
TLE2142ID	ACTIVE	SOIC	D	8	75	Green (RoHS & no Sb/Br)	CU NIPDAU	Level-1-260C-UNLIM
TLE2142IDG4	ACTIVE	SOIC	D	8	75	Green (RoHS & no Sb/Br)	CU NIPDAU	Level-1-260C-UNLIM
TLE2142IDR	ACTIVE	SOIC	D	8	2500	Green (RoHS & no Sb/Br)	CU NIPDAU	Level-1-260C-UNLIM
TLE2142IDRG4	ACTIVE	SOIC	D	8	2500	Green (RoHS & no Sb/Br)	CU NIPDAU	Level-1-260C-UNLIM
TLE2142IP	ACTIVE	PDIP	P	8	50	Pb-Free (RoHS)	CU NIPDAU	N / A for Pkg Type
TLE2142IPE4	ACTIVE	PDIP	P	8	50	Pb-Free (RoHS)	CU NIPDAU	N / A for Pkg Type
TLE2142MD	ACTIVE	SOIC	D	8	75	TBD	CU NIPDAU	Level-1-220C-UNLIM
TLE2142MDG4	ACTIVE	SOIC	D	8	75	Green (RoHS & no Sb/Br)	CU NIPDAU	Level-1-260C-UNLIM
TLE2142MDR	ACTIVE	SOIC	D	8	2500	TBD	CU NIPDAU	Level-1-220C-UNLIM
TLE2142MDRG4	ACTIVE	SOIC	D	8	2500	Green (RoHS & no Sb/Br)	CU NIPDAU	Level-1-260C-UNLIM
TLE2142MFKB	ACTIVE	LCCC	FK	20	1	TBD	POST-PLATE	N / A for Pkg Type
TLE2142MJGB	ACTIVE	CDIP	JG	8	1	TBD	A42 SNPB	N / A for Pkg Type
TLE2142MUB	ACTIVE	CFP	U	10	1	TBD	A42 SNPB	N / A for Pkg Type
TLE2144ACN	ACTIVE	PDIP	N	14	25	Pb-Free (RoHS)	CU NIPDAU	N / A for Pkg Type
TLE2144ACNE4	ACTIVE	PDIP	N	14	25	Pb-Free (RoHS)	CU NIPDAU	N / A for Pkg Type
TLE2144AIN	ACTIVE	PDIP	N	14	25	Pb-Free (RoHS)	CU NIPDAU	N / A for Pkg Type
TLE2144AINE4	ACTIVE	PDIP	N	14	25	Pb-Free (RoHS)	CU NIPDAU	N / A for Pkg Type
TLE2144AMFKB	ACTIVE	LCCC	FK	20	1	TBD	POST-PLATE	N / A for Pkg Type
TLE2144AMJB	ACTIVE	CDIP	J	14	1	TBD	A42 SNPB	N / A for Pkg Type
TLE2144CDW	ACTIVE	SOIC	DW	16	40	Green (RoHS & no Sb/Br)	CU NIPDAU	Level-1-260C-UNLIM
TLE2144CDWG4	ACTIVE	SOIC	DW	16	40	Green (RoHS & no Sb/Br)	CU NIPDAU	Level-1-260C-UNLIM
TLE2144CDWR	ACTIVE	SOIC	DW	16	2000	Green (RoHS & no Sb/Br)	CU NIPDAU	Level-1-260C-UNLIM
TLE2144CDWRG4	ACTIVE	SOIC	DW	16	2000	Green (RoHS & no Sb/Br)	CU NIPDAU	Level-1-260C-UNLIM
TLE2144CN	ACTIVE	PDIP	N	14	25	Pb-Free (RoHS)	CU NIPDAU	N / A for Pkg Type
TLE2144CNE4	ACTIVE	PDIP	N	14	25	Pb-Free (RoHS)	CU NIPDAU	N / A for Pkg Type
TLE2144IDW	ACTIVE	SOIC	DW	16	40	Green (RoHS & no Sb/Br)	CU NIPDAU	Level-1-260C-UNLIM
TLE2144IDWG4	ACTIVE	SOIC	DW	16	40	Green (RoHS & no Sb/Br)	CU NIPDAU	Level-1-260C-UNLIM

Orderable Device	Status ⁽¹⁾	Package Type	Package Drawing	Pins	Package Qty	Eco Plan ⁽²⁾	Lead/Ball Finish	MSL Peak Temp ⁽³⁾
						no Sb/Br)		
TLE2144IDWR	ACTIVE	SOIC	DW	16	2000	Green (RoHS & no Sb/Br)	CU NIPDAU	Level-1-260C-UNLIM
TLE2144IDWRG4	ACTIVE	SOIC	DW	16	2000	Green (RoHS & no Sb/Br)	CU NIPDAU	Level-1-260C-UNLIM
TLE2144IN	ACTIVE	PDIP	N	14	25	Pb-Free (RoHS)	CU NIPDAU	N / A for Pkg Type
TLE2144INE4	ACTIVE	PDIP	N	14	25	Pb-Free (RoHS)	CU NIPDAU	N / A for Pkg Type
TLE2144MDW	ACTIVE	SOIC	DW	16	40	TBD	CU NIPDAU	Level-1-220C-UNLIM
TLE2144MDWG4	ACTIVE	SOIC	DW	16	40	Green (RoHS & no Sb/Br)	CU NIPDAU	Level-1-260C-UNLIM
TLE2144MFKB	ACTIVE	LCCC	FK	20	1	TBD	POST-PLATE	N / A for Pkg Type
TLE2144MJB	ACTIVE	CDIP	J	14	1	TBD	A42 SNPB	N / A for Pkg Type
TLE2144MN	OBSOLETE	PDIP	N	14		TBD	Call TI	Call TI

⁽¹⁾ The marketing status values are defined as follows:

ACTIVE: Product device recommended for new designs.

LIFEBUY: TI has announced that the device will be discontinued, and a lifetime-buy period is in effect.

NRND: Not recommended for new designs. Device is in production to support existing customers, but TI does not recommend using this part in a new design.

PREVIEW: Device has been announced but is not in production. Samples may or may not be available.

OBSOLETE: TI has discontinued the production of the device.

⁽²⁾ Eco Plan - The planned eco-friendly classification: Pb-Free (RoHS), Pb-Free (RoHS Exempt), or Green (RoHS & no Sb/Br) - please check <http://www.ti.com/productcontent> for the latest availability information and additional product content details.

TBD: The Pb-Free/Green conversion plan has not been defined.

Pb-Free (RoHS): TI's terms "Lead-Free" or "Pb-Free" mean semiconductor products that are compatible with the current RoHS requirements for all 6 substances, including the requirement that lead not exceed 0.1% by weight in homogeneous materials. Where designed to be soldered at high temperatures, TI Pb-Free products are suitable for use in specified lead-free processes.

Pb-Free (RoHS Exempt): This component has a RoHS exemption for either 1) lead-based flip-chip solder bumps used between the die and package, or 2) lead-based die adhesive used between the die and leadframe. The component is otherwise considered Pb-Free (RoHS compatible) as defined above.

Green (RoHS & no Sb/Br): TI defines "Green" to mean Pb-Free (RoHS compatible), and free of Bromine (Br) and Antimony (Sb) based flame retardants (Br or Sb do not exceed 0.1% by weight in homogeneous material)

⁽³⁾ MSL, Peak Temp. -- The Moisture Sensitivity Level rating according to the JEDEC industry standard classifications, and peak solder temperature.

Important Information and Disclaimer: The information provided on this page represents TI's knowledge and belief as of the date that it is provided. TI bases its knowledge and belief on information provided by third parties, and makes no representation or warranty as to the accuracy of such information. Efforts are underway to better integrate information from third parties. TI has taken and continues to take reasonable steps to provide representative and accurate information but may not have conducted destructive testing or chemical analysis on incoming materials and chemicals. TI and TI suppliers consider certain information to be proprietary, and thus CAS numbers and other limited information may not be available for release.

In no event shall TI's liability arising out of such information exceed the total purchase price of the TI part(s) at issue in this document sold by TI to Customer on an annual basis.

TAPE AND REEL BOX INFORMATION

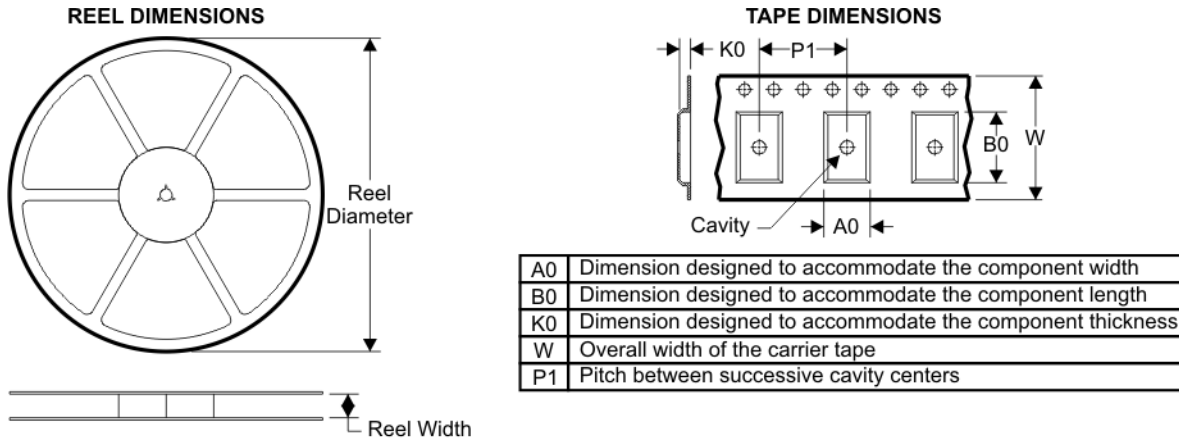

QUADRANT ASSIGNMENTS FOR PIN 1 ORIENTATION IN TAPE

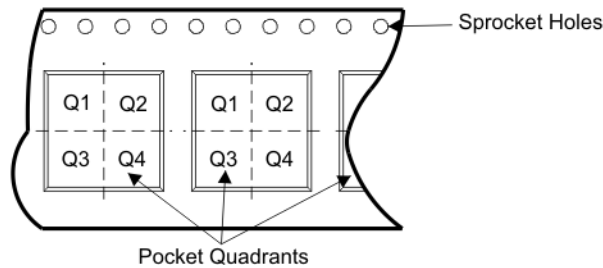

Device	Package	Pins	Site	Reel Diameter (mm)	Reel Width (mm)	A0 (mm)	B0 (mm)	K0 (mm)	P1 (mm)	W (mm)	Pin1 Quadrant
TLE2141AIDR	D	8	SITE 60	330	12	6.4	5.2	2.1	8	12	Q1
TLE2141CDR	D	8	SITE 60	330	12	6.4	5.2	2.1	8	12	Q1
TLE2141IDR	D	8	SITE 60	330	12	6.4	5.2	2.1	8	12	Q1
TLE2142ACDR	D	8	SITE 60	330	12	6.4	5.2	2.1	8	12	Q1
TLE2142AIDR	D	8	SITE 60	330	12	6.4	5.2	2.1	8	12	Q1
TLE2142CDR	D	8	SITE 60	330	12	6.4	5.2	2.1	8	12	Q1
TLE2142CPWR	PW	16	SITE 41	330	12	7.0	5.6	1.6	8	12	Q1
TLE2142IDR	D	8	SITE 60	330	12	6.4	5.2	2.1	8	12	Q1
TLE2144CDWR	DW	16	SITE 60	330	16	10.75	10.7	2.7	12	16	Q1
TLE2144IDWR	DW	16	SITE 60	330	16	10.75	10.7	2.7	12	16	Q1

TAPE AND REEL BOX DIMENSIONS



Device	Package	Pins	Site	Length (mm)	Width (mm)	Height (mm)
TLE2141AIDR	D	8	SITE 60	346.0	346.0	29.0
TLE2141CDR	D	8	SITE 60	346.0	346.0	29.0
TLE2141IDR	D	8	SITE 60	346.0	346.0	29.0
TLE2142ACDR	D	8	SITE 60	346.0	346.0	29.0
TLE2142AIDR	D	8	SITE 60	346.0	346.0	29.0
TLE2142CDR	D	8	SITE 60	346.0	346.0	29.0
TLE2142CPWR	PW	16	SITE 41	346.0	346.0	29.0
TLE2142IDR	D	8	SITE 60	346.0	346.0	29.0
TLE2144CDWR	DW	16	SITE 60	346.0	346.0	33.0
TLE2144IDWR	DW	16	SITE 60	346.0	346.0	33.0

JG (R-GDIP-T8)

CERAMIC DUAL-IN-LINE

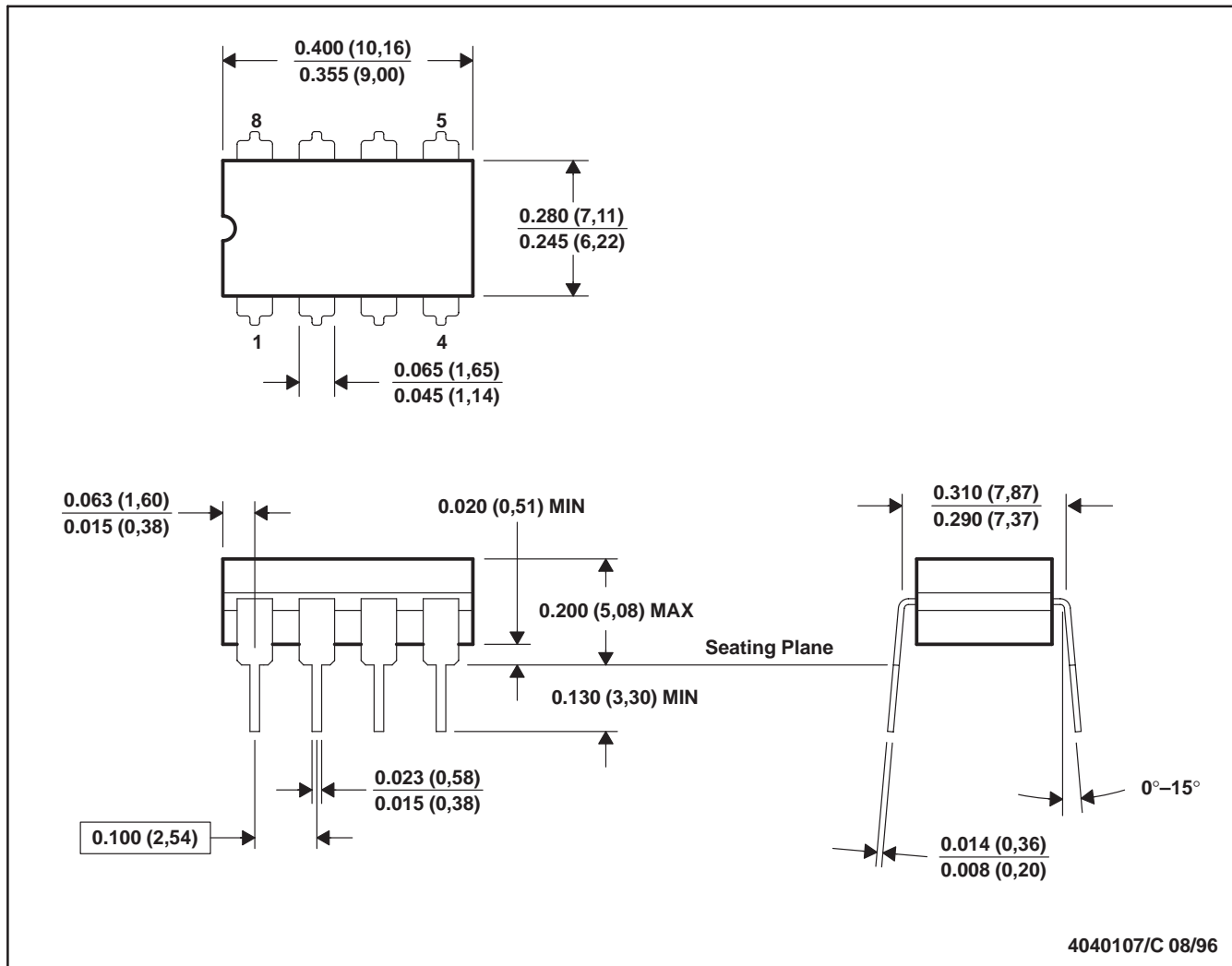

- NOTES: A. All linear dimensions are in inches (millimeters).
 B. This drawing is subject to change without notice.
 C. This package can be hermetically sealed with a ceramic lid using glass frit.
 D. Index point is provided on cap for terminal identification.
 E. Falls within MIL STD 1835 GDIP1-T8

J (R-GDIP-T**)

14 LEADS SHOWN

CERAMIC DUAL IN-LINE PACKAGE



DIM \ PINS **	14	16	18	20
A	0.300 (7,62) BSC	0.300 (7,62) BSC	0.300 (7,62) BSC	0.300 (7,62) BSC
B MAX	0.785 (19,94)	.840 (21,34)	0.960 (24,38)	1.060 (26,92)
B MIN	—	—	—	—
C MAX	0.300 (7,62)	0.300 (7,62)	0.310 (7,87)	0.300 (7,62)
C MIN	0.245 (6,22)	0.245 (6,22)	0.220 (5,59)	0.245 (6,22)



4040083/F 03/03

- NOTES:
- All linear dimensions are in inches (millimeters).
 - This drawing is subject to change without notice.
 - This package is hermetically sealed with a ceramic lid using glass frit.
 - Index point is provided on cap for terminal identification only on press ceramic glass frit seal only.
 - Falls within MIL STD 1835 GDIP1-T14, GDIP1-T16, GDIP1-T18 and GDIP1-T20.

U (S-GDFP-F10)

CERAMIC DUAL FLATPACK

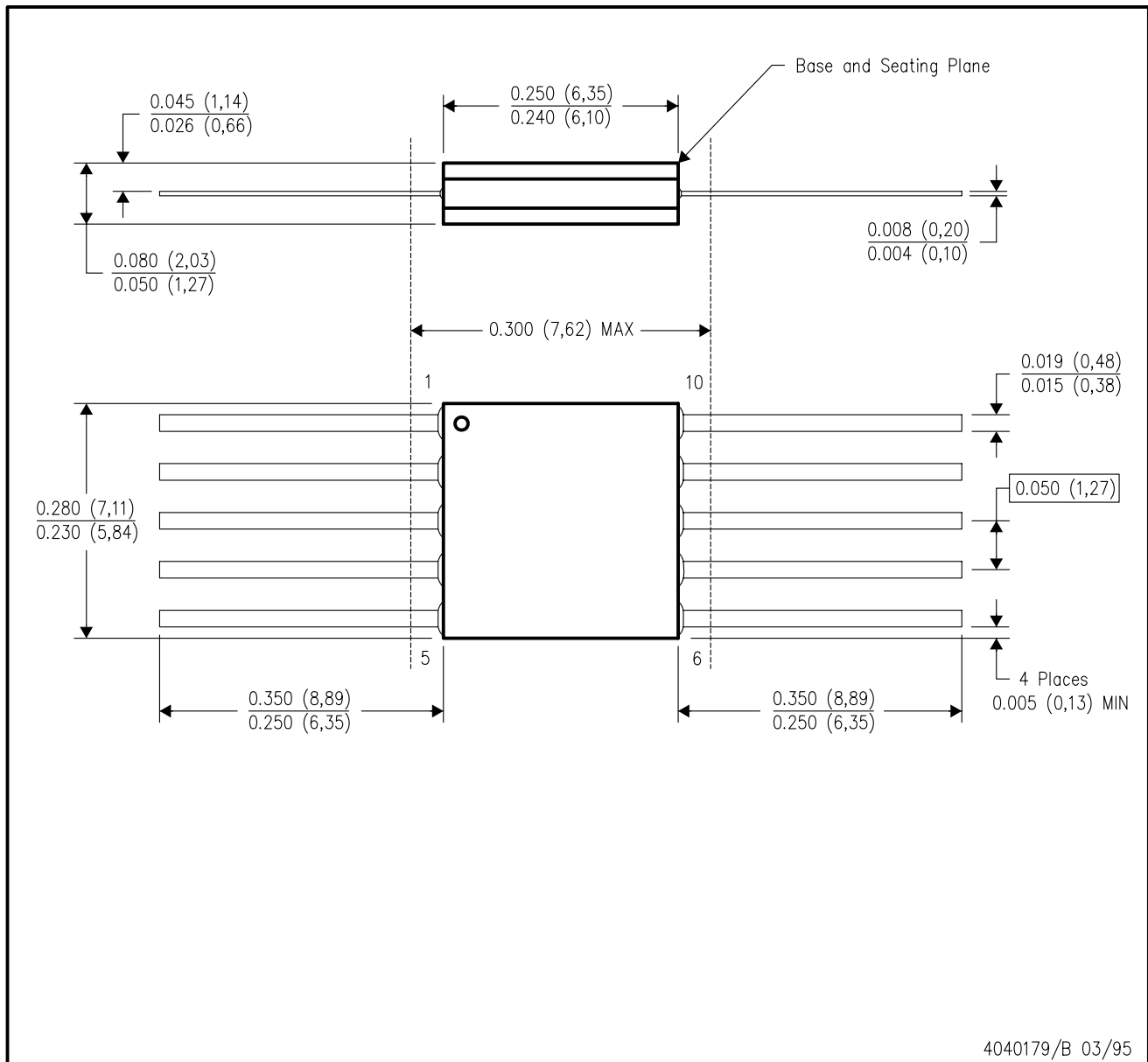

4040179/B 03/95

- NOTES:
- A. All linear dimensions are in inches (millimeters).
 - B. This drawing is subject to change without notice.
 - C. This package can be hermetically sealed with a ceramic lid using glass frit.
 - D. Index point is provided on cap for terminal identification only.
 - E. Falls within MIL STD 1835 GDFP1-F10 and JEDEC MO-092AA

FK (S-CQCC-N**)

LEADLESS CERAMIC CHIP CARRIER

28 TERMINAL SHOWN



- NOTES:
- A. All linear dimensions are in inches (millimeters).
 - B. This drawing is subject to change without notice.
 - C. This package can be hermetically sealed with a metal lid.
 - D. The terminals are gold plated.
 - E. Falls within JEDEC MS-004

P (R-PDIP-T8)

PLASTIC DUAL-IN-LINE



4040082/D 05/98

- NOTES: A. All linear dimensions are in inches (millimeters).
 B. This drawing is subject to change without notice.
 C. Falls within JEDEC MS-001

For the latest package information, go to http://www.ti.com/sc/docs/package/pkg_info.htm



N (R-PDIP-T**)

PLASTIC DUAL-IN-LINE PACKAGE

16 PINS SHOWN



- NOTES:
- A. All linear dimensions are in inches (millimeters).
 - B. This drawing is subject to change without notice.
 - Falls within JEDEC MS-001, except 18 and 20 pin minimum body length (Dim A).
 - The 20 pin end lead shoulder width is a vendor option, either half or full width.

D (R-PDSO-G8)

PLASTIC SMALL-OUTLINE PACKAGE

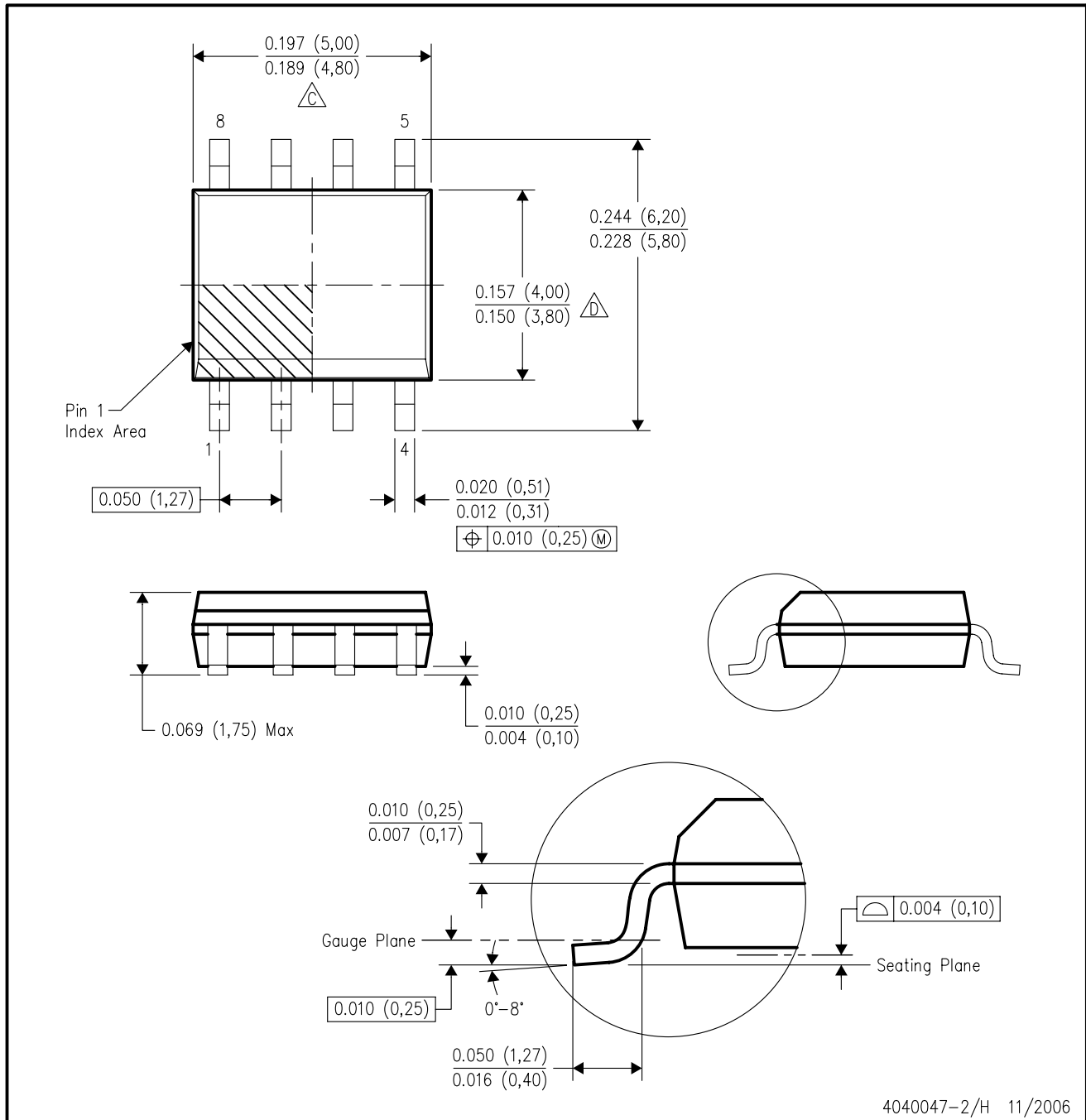

- NOTES:
- A. All linear dimensions are in inches (millimeters).
 - B. This drawing is subject to change without notice.
 - C. Body length does not include mold flash, protrusions, or gate burrs. Mold flash, protrusions, or gate burrs shall not exceed .006 (0,15) per end.
 - D. Body width does not include interlead flash. Interlead flash shall not exceed .017 (0,43) per side.
 - E. Reference JEDEC MS-012 variation AA.

DW (R-PDSO-G16)

PLASTIC SMALL-OUTLINE PACKAGE

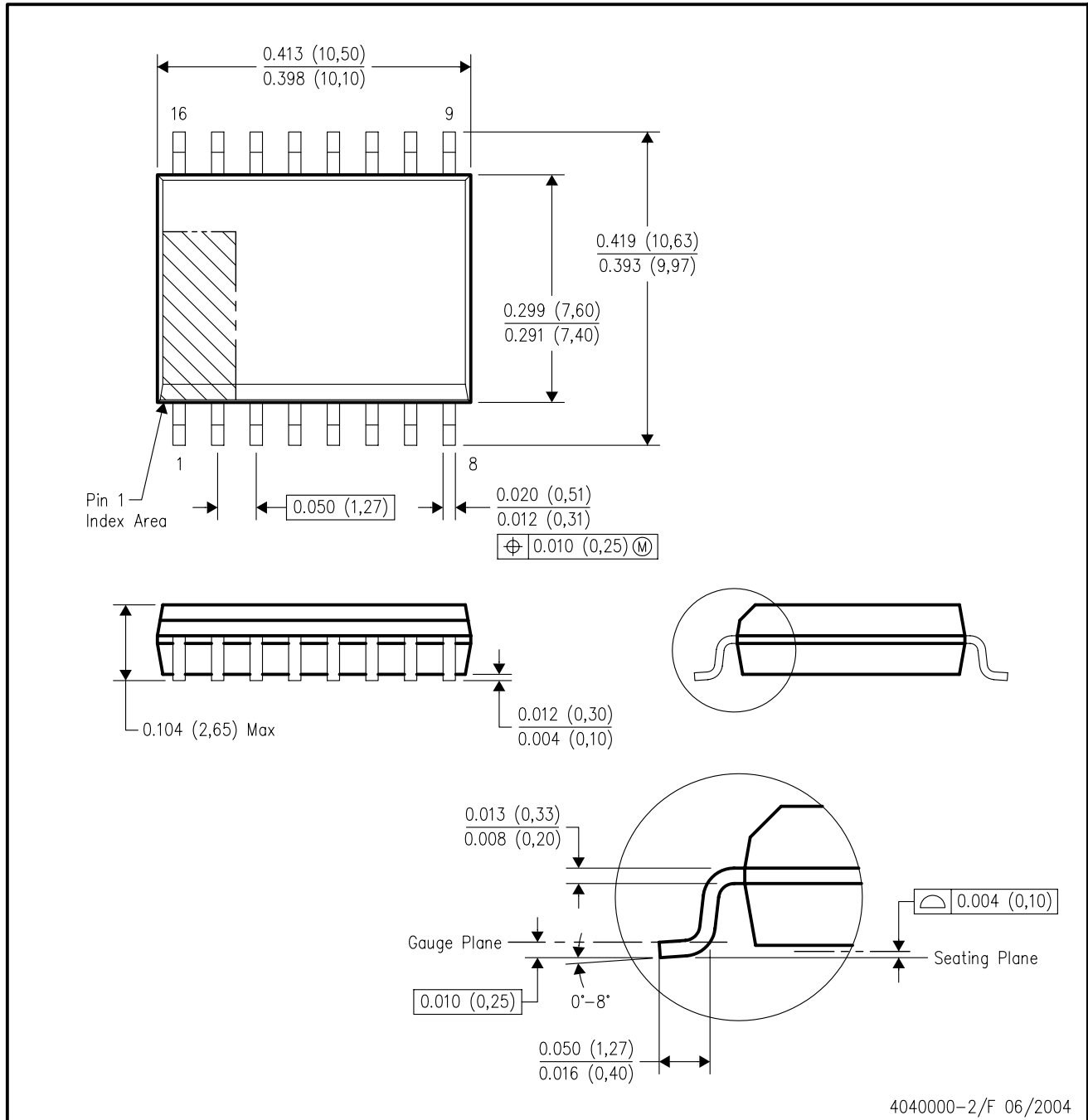

4040000-2/F 06/2004

- NOTES:
- A. All linear dimensions are in inches (millimeters).
 - B. This drawing is subject to change without notice.
 - C. Body dimensions do not include mold flash or protrusion not to exceed 0.006 (0,15).
 - D. Falls within JEDEC MS-013 variation AA.

PW (R-PDSO-G**)

PLASTIC SMALL-OUTLINE PACKAGE

14 PINS SHOWN



4040064/F 01/97

- NOTES: A. All linear dimensions are in millimeters.
 B. This drawing is subject to change without notice.
 C. Body dimensions do not include mold flash or protrusion not to exceed 0,15.
 D. Falls within JEDEC MO-153

IMPORTANT NOTICE

Texas Instruments Incorporated and its subsidiaries (TI) reserve the right to make corrections, modifications, enhancements, improvements, and other changes to its products and services at any time and to discontinue any product or service without notice. Customers should obtain the latest relevant information before placing orders and should verify that such information is current and complete. All products are sold subject to TI's terms and conditions of sale supplied at the time of order acknowledgment.

TI warrants performance of its hardware products to the specifications applicable at the time of sale in accordance with TI's standard warranty. Testing and other quality control techniques are used to the extent TI deems necessary to support this warranty. Except where mandated by government requirements, testing of all parameters of each product is not necessarily performed.

TI assumes no liability for applications assistance or customer product design. Customers are responsible for their products and applications using TI components. To minimize the risks associated with customer products and applications, customers should provide adequate design and operating safeguards.

TI does not warrant or represent that any license, either express or implied, is granted under any TI patent right, copyright, mask work right, or other TI intellectual property right relating to any combination, machine, or process in which TI products or services are used. Information published by TI regarding third-party products or services does not constitute a license from TI to use such products or services or a warranty or endorsement thereof. Use of such information may require a license from a third party under the patents or other intellectual property of the third party, or a license from TI under the patents or other intellectual property of TI.

Reproduction of TI information in TI data books or data sheets is permissible only if reproduction is without alteration and is accompanied by all associated warranties, conditions, limitations, and notices. Reproduction of this information with alteration is an unfair and deceptive business practice. TI is not responsible or liable for such altered documentation. Information of third parties may be subject to additional restrictions.

Resale of TI products or services with statements different from or beyond the parameters stated by TI for that product or service voids all express and any implied warranties for the associated TI product or service and is an unfair and deceptive business practice. TI is not responsible or liable for any such statements.

TI products are not authorized for use in safety-critical applications (such as life support) where a failure of the TI product would reasonably be expected to cause severe personal injury or death, unless officers of the parties have executed an agreement specifically governing such use. Buyers represent that they have all necessary expertise in the safety and regulatory ramifications of their applications, and acknowledge and agree that they are solely responsible for all legal, regulatory and safety-related requirements concerning their products and any use of TI products in such safety-critical applications, notwithstanding any applications-related information or support that may be provided by TI. Further, Buyers must fully indemnify TI and its representatives against any damages arising out of the use of TI products in such safety-critical applications.

TI products are neither designed nor intended for use in military/aerospace applications or environments unless the TI products are specifically designated by TI as military-grade or "enhanced plastic." Only products designated by TI as military-grade meet military specifications. Buyers acknowledge and agree that any such use of TI products which TI has not designated as military-grade is solely at the Buyer's risk, and that they are solely responsible for compliance with all legal and regulatory requirements in connection with such use.

TI products are neither designed nor intended for use in automotive applications or environments unless the specific TI products are designated by TI as compliant with ISO/TS 16949 requirements. Buyers acknowledge and agree that, if they use any non-designated products in automotive applications, TI will not be responsible for any failure to meet such requirements.

Following are URLs where you can obtain information on other Texas Instruments products and application solutions:

Products		Applications	
Amplifiers	amplifier.ti.com	Audio	www.ti.com/audio
Data Converters	dataconverter.ti.com	Automotive	www.ti.com/automotive
DSP	dsp.ti.com	Broadband	www.ti.com/broadband
Interface	interface.ti.com	Digital Control	www.ti.com/digitalcontrol
Logic	logic.ti.com	Military	www.ti.com/military
Power Mgmt	power.ti.com	Optical Networking	www.ti.com/opticalnetwork
Microcontrollers	microcontroller.ti.com	Security	www.ti.com/security
RFID	www.ti-rfid.com	Telephony	www.ti.com/telephony
Low Power Wireless	www.ti.com/lpw	Video & Imaging	www.ti.com/video
		Wireless	www.ti.com/wireless

Mailing Address: Texas Instruments, Post Office Box 655303, Dallas, Texas 75265
Copyright © 2007, Texas Instruments Incorporated