

Features

Regulated Converter

- Wide input voltage range (32-96VDC)
- Water & dust proof (IP67), robust and reliable
- Operating temperature range: -40°C to +90°C
- Protections: Input Reverse Polarity Protection, Input UVLO, Output OCP, SCP, OVP, OTP
- Parallel operation capability
- Control ON/OFF function

RECOM
DC/DC Converter

RMOD500-W

500 Watt
4.53" x 8.0"
Single Output



UL62368-1 certified
CAN/CSA-C22.2 No. 62368-1 certified
EN62368-1 certified

Description

The RMOD500-W DC-DC converter is ideally for the use in all off-highway electric vehicles. This family is an extremely robust plug & play module with 500 Watts, which generates the isolated $V_{out} = 12.4 / 13.7 / 24.5VDC$ low voltage network from the traction battery level. The wide input voltage range 32-96V covers the common 48V and 80V battery voltages in this off-highway segment. Thanks to the waterproof and dust proof housing construction, the devices can directly be connected mechanically and thermally to the chassis (i.e. at any point on the vehicle) and operate reliably even under the most adverse conditions.

Selection Guide

Part Number	Input Voltage Range [VDC]	nom. Output Voltage [VDC]	max. Output Current [A]	Efficiency min. ⁽¹⁾ [%]
RMOD500-60-13.7SW	32-96	13.7	36.5	89.5
RMOD500-60-13SW/OR	32-96	13	38.5	89.5
RMOD500-60-12.4SW	32-96	12.4	40	88.2
RMOD500-60-11.7SW/OR	32-96	11.7	42.5	88.2
RMOD500-60-24.5SW	32-96	24.5	21	91.5
RMOD500-60-23.5SW/OR	32-96	23.5	21	91.5

Notes:

Note1: Efficiency is tested at nominal input and 100% +25°C ambient

Model Numbering

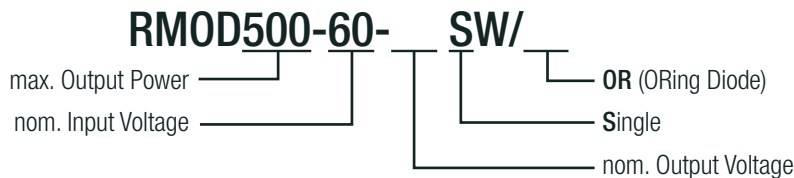

Specifications (measured @ $T_a = 25^\circ C$, nom. V_{in} , full load and after warm-up unless otherwise stated)

BASIC CHARACTERISTICS					
Parameter	Condition		Min.	Typ.	Max.
Input Voltage Range	nom. $V_{in} = 48VDC$		32VDC	48VDC	96VDC
Under Voltage Lockout (UVLO)	DC-DC ON		29VDC	30VDC	31VDC
	DC-DC OFF		27VDC	28VDC	29VDC
	hysteresis		1VDC	2VDC	3VDC
Input Current	$V_{in} = 32VDC$			18A	19A
Quiescent Current	$V_{in} = 48VDC$			80mA	
	$V_{in} = 72, 80VDC$	$V_{out} = 12.4/13.7VDC$		40mA	
		$V_{out} = 24VDC$		50mA	
Standby Current	$V_{in} = 48VDC$	$V_{out} = 12.4/13.7VDC$		6mA	
		$V_{out} = 24VDC$		20mA	
Start-up Time	$V_{in} = 48VDC$	from $V_{in} =$ Turn-on, threshold to 10% V_{out}		650ms	800ms
		from CTRL = on to 10% V_{out}		250ms	400ms

continued on next page

Specifications (measured @ Ta= 25°C, nom. Vin, full load and after warm-up unless otherwise stated)

Parameter	Condition	Min.	Typ.	Max.
Rise Time	10% to 90% V _{OUT}		160ms	300ms
Internal Operating Frequency			175kHz	
Output Ripple & Noise ⁽²⁾	20MHz BW	V _{IN} = 48VDC; peak to peak	120mVp-p	240mVp-p
		V _{IN} = 48VDC; RMS	35mVp-p	70mVp-p
		V _{IN} = 72VDC, 80VDC; peak to peak	140mVp-p	280mVp-p
		V _{IN} = 72VDC, 80VDC; RMS	45mVp-p	90mVp-p
Reflected back Ripple Current	V _{IN} = 48VDC		0.2Ap-p	
Max. Capacitive Load				10000µF

Notes:

Note2: Measurements are made with a 0.1µF MLCC & 10µF tantalum in parallel across output. (low ESR)

RMOD500-60-13.7SW

Efficiency vs Load

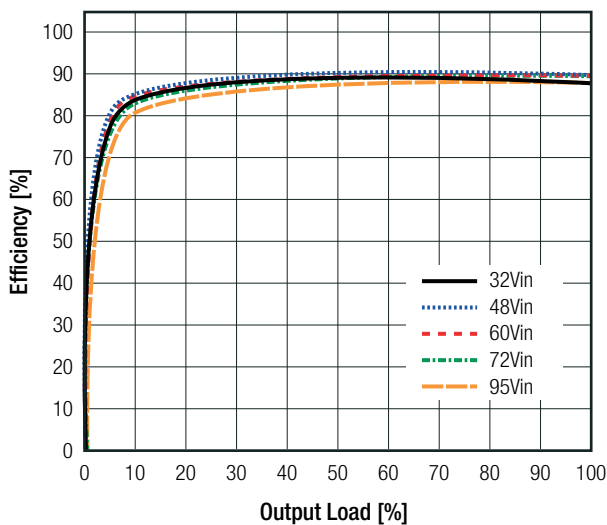

Power Dissipation vs Load

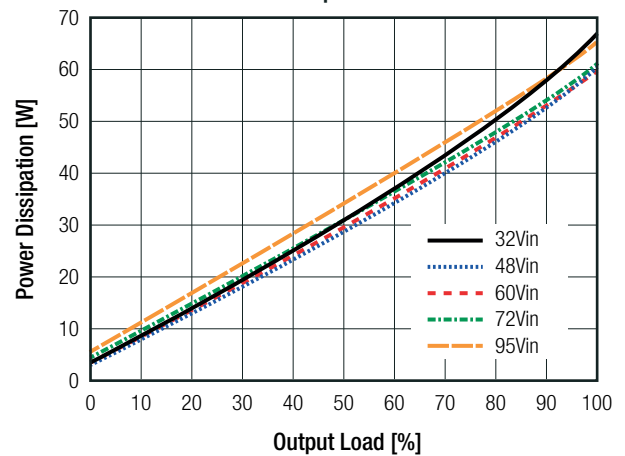

CTRL ON/OFF (non-isolated to primary side)

Parameter	Condition	Value
ON/OFF CTRL	DC-DC ON	CTRL Pin to +V _{IN} or floating
	DC-DC OFF	CTRL Pin to -V _{IN}

REGULATIONS

Parameter	Condition	Min.	Typ.	Max.
Current Share Accuracy	only OR types		10%	15%
Transient Response Recovery Time	50-75% load dynamic, 0.1A/µs slew rate		250µs	500µs

Deviation vs. Load (nom. V_{IN})

RMOD500-60-13.7SW

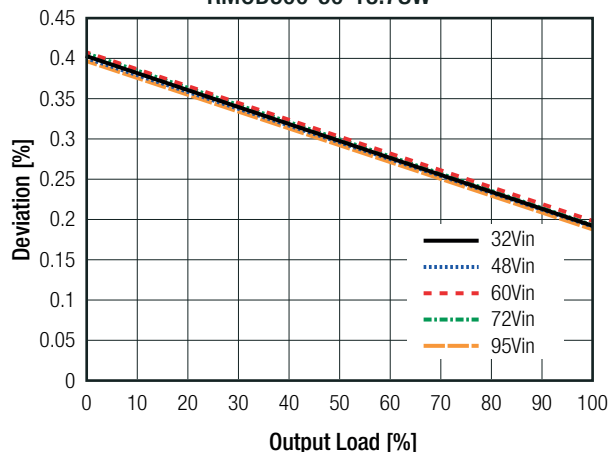

Specifications (measured @ Ta= 25°C, nom. Vin, full load and after warm-up unless otherwise stated)

PROTECTIONS		
Parameter	Type	Value
Internal Input Fuse		500V/30A Fast-acting fuse
Short Circuit Protection (SCP)		hiccup mode, automatic recovery
Input Reverse Polarity Protection		-96VDC
Over Voltage Protection (OVP)	RMOD500-60-12.4SW and RMOD500-60-11.7SW/OR	17VDC typ., hiccup mode, auto recovery
	RMOD500-60-13.7SW and RMOD500-60-13SW/OR	17-19VDC, hiccup mode, auto recovery
	RMOD500-60-24.5SW and RMOD500-60-23.5SW/OR	28-30VDC, hiccup mode, auto recovery
Over Current Protection (OCP)	RMOD500-60-12.4SW and RMOD500-60-11.7SW/OR	50A, hiccup mode
	RMOD500-60-13.7SW and RMOD500-60-13SW/OR	39-51A, hiccup mode
	RMOD500-60-24.5SW and RMOD500-60-23.5SW/OR	23-27A, hiccup mode
Over Voltage Category	according to UL62368-1	OVC1
Over Temperature Protection (OTP) ⁽³⁾	measured on NTC	118°C typ., automatic restart
Isolation Voltage ⁽⁴⁾	I/P to O/P; I/P to case	2250VDC
	O/P to case	550VDC
Isolation Resistance	I/P to O/P	10MΩ min.
Isolation Capacitance	I/P to O/P	5000pF typ.
Insulation Grade		basic

Notes:

Note3: If the temperature exceeds the preset temperature threshold the module will shut down

Note4: For repeat Hi-Pot testing, reduce the time and/or the test voltage

ENVIRONMENTAL

Parameter	Condition	Value	
Operating Ambient Temperature Range	with derating, refer to <i>"Thermal Consideration"</i>	-40°C to +90°C	
Operating Humidity	non-condensing	95% RH max.	
Operating Altitude	according to UL62368-1	5000m	
IP Rating		IP67	
Pollution Degree	according to UL62368-1	PD2	
MTBF	V _{IN} =72VDC, T _{BASE} = +80°C	RMOD500-60-12.4SW and RMOD500-60-11.7SW/OR	121.4 x 10 ³ hours
		RMOD500-60-13.7SW and RMOD500-60-13SW/OR	137.1 x 10 ³ hours
		RMOD500-60-24.5SW and RMOD500-60-23.5SW/OR	143.6 x 10 ³ hours

Thermal Consideration

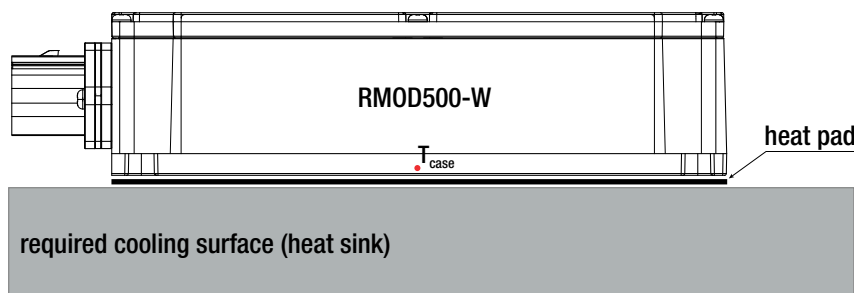

T_{amb}

natural convection 0.1m/s

The module can be used in enclosed applications, as long as the cooling is sufficient to keep the baseplate temperature below 90°C. The surrounding temperature should not exceed +90°C.

continued on next page

Specifications (measured @ Ta= 25°C, nom. Vin, full load and after warm-up unless otherwise stated)

Derating Graph ⁽⁵⁾

(@ Chamber and natural convection 0.1m/s)

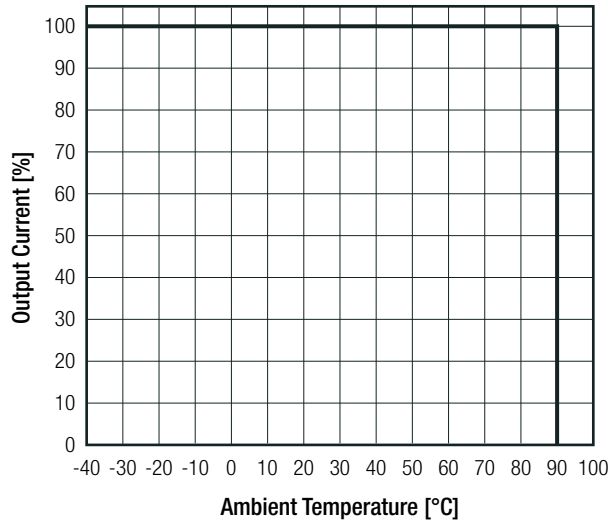

Notes:

Note5: Mount the device on a sufficient heat-sink, the baseplate temperature should never exceed 90°C.

SAFETY AND CERTIFICATIONS

Audio/Video, information and communication technology equipment - Part1: Safety requirements	E224736-A6023-UL	UL62368-1:2014
		CAN/CSA-C22.2 NO. 62368-1:2014
		EN62368-1:2014 + A11:2017
RoHS2		ROHS-2011/65/EU + AM-2015/863

ENVIRONMENTAL (RAILWAY STANDARDS)

Parameter	Condition	Value
Temperature Shock	Temperature range:-40~125°C Thermal rate: 20°C/min Dwell time : 60mins Total cycle: 300cycles	ISO 16750-4
Vibration	Sine wave 1.Frequency (Hz) amplitude acceleration 5 – 9 HZ ±15 mm 15-200 HZ 10G 2. Sweep rate 1 Oct / min. 3. Duration 50 Cycles.	IEC 60068-2-6: Sine-wave vibration, test Fc
Submersion test	Total cycles : 10 Dwell time at Tmax : 1h Transition duration : <20s Test-fluid: De-ionized water,5% NaCl Water Temperature:<4°C Immersion Time : 5 mins	ISO 16750-4
Mechanical Shock	50G/11ms 3Shocks for each direction	IEC 60068-2-27: Shock, half sine, test Ea
Salt Spray	Operating /no load 1. Salt Spray Concentration:5%; 2. Test Temperature:35°C; 3. Volume of spray:1~2ml/hour/80cm2; 4. PH:6.5~7.2; 5. Test Time:96hours 6. Tolerance: Salt Spray Concentration (±1%); Test Temperature: ± 2°C;	IEC 60068-2-11:Test Ka

continued on next page

Specifications (measured @ Ta= 25°C, nom. Vin, full load and after warm-up unless otherwise stated)

Parameter	Condition	Value
Bump	40G/6ms 1000 Shocks for each direction	IEC 60068-2-29: Bump, test Eb
Emission	30-1000MHz 34-45dBuV/m	EN12895-2015
Immunity	20V/m /27-1000MHz AM; 3V/m /1-2GHz AM; 1V/m /2-2.7GHz AM EN12895-2015,	EN61000-4-3
ESD	Direct: ±8KV; Air: ±15KV EN12895-2015,	EN61000-4-2

DIMENSION AND PHYSICAL CHARACTERISTICS

Parameter	Type	Value
Material	case	aluminum
Dimension (LxWxH)	with connector	198.0 x 113.0 x 45.0mm
Weight		1.3kg typ.

Dimension Drawing (mm)

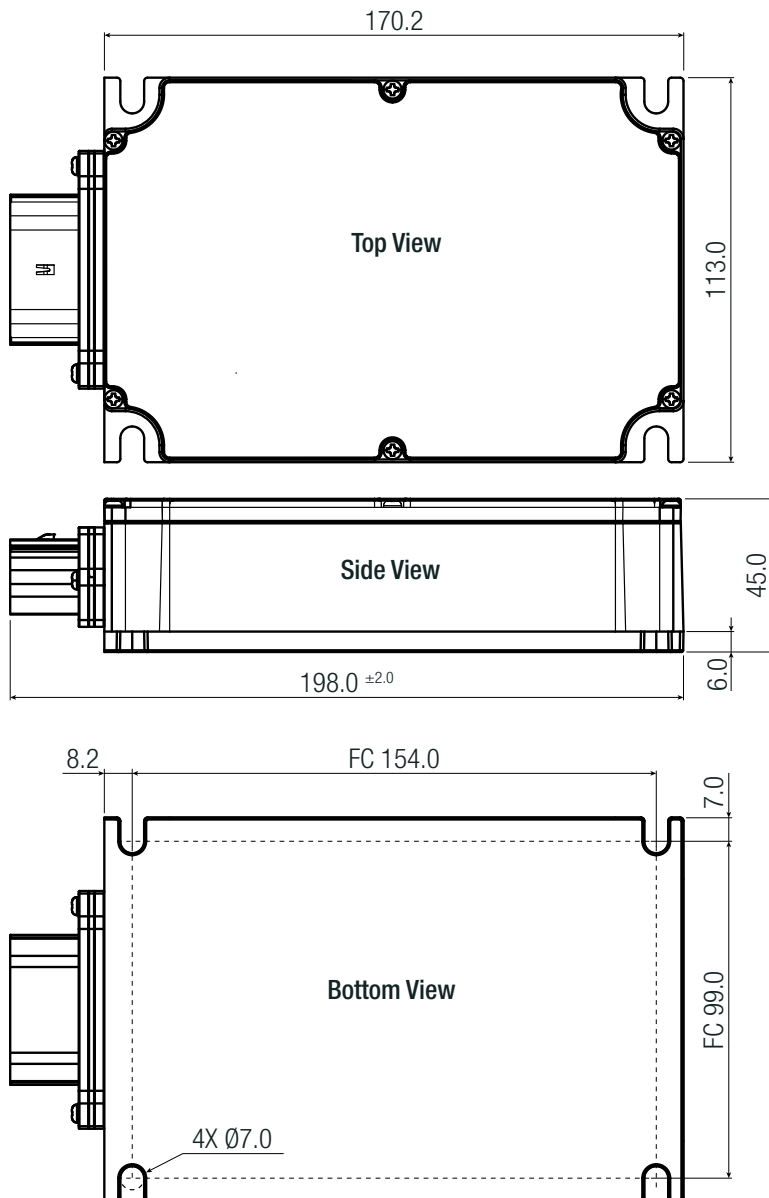

Front Side

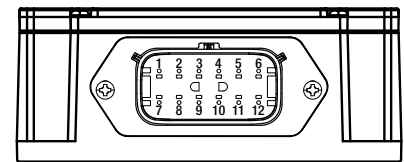

Connector Information

Pin	Function
1	CTRL
2, 3	+VIN
4, 5, 6	-VOUT
7	NA
8, 9	-VIN
10, 11, 12	+VOUT

FC= Fixing Center

Pin7 needs to be filled with plug

Compatible Connector

Connector	Housing
Molex 19429-0047	0194180027 X1

Tolerance:

xx.x= ±0.5mm

xx.xx= ±0.25mm

Specifications (measured @ Ta= 25°C, nom. Vin, full load and after warm-up unless otherwise stated)

PARALLEL OPERATION

Parallel operation is possible with all combinations DC/DC converter versions providing they have the same rated input voltage.
Use the same wire length for each power supply (star connection) and energize all units at the same time to avoid triggering overload protection.
For operation with more than two power supplies in parallel operation, please contact RECOM technical support for advice.

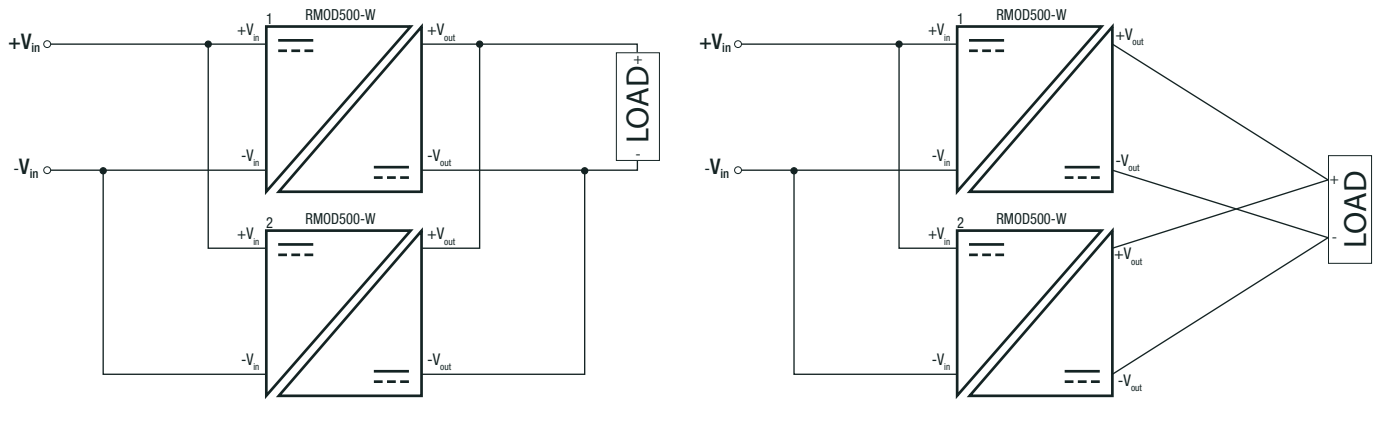

PACKAGING INFORMATION

Parameter	Type	Value
Packaging Dimension (LxWxH)	cardboard box	500.0 x 300.0 x 200.0mm
Packaging Quantity		6pcs
Storage Temperature Range		-40°C to +105°C

The product information and specifications may be subject to changes even without prior written notice. The product has been designed for various applications; its suitability lies in the responsibility of each customer. The products are not authorized for use in safety-critical applications without RECOM's explicit written consent. A safety-critical application is an application where a failure may reasonably be expected to endanger or cause loss of life, inflict bodily harm or damage property. The applicant shall indemnify and hold harmless RECOM, its affiliated companies and its representatives against any damage claims in connection with the unauthorized use of RECOM products in such safety-critical applications.