

Part Number: 36 Series
High Current - 1 Form A - PhotoDMOS Relays
Product Data Sheet

60 VOLTS

High Current up to 2.5A

PICTURE

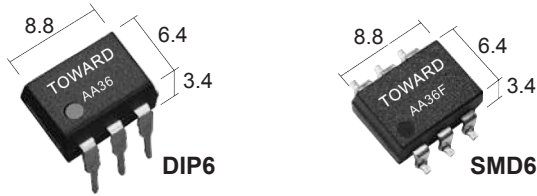

Drawings not to scale. All dimensions in mm nominal. Pitch: 2.54 mm

RoHS Compliant

ORDERING INFORMATION

Body Style	Series	Options
AA = DIP(6 pin)	36	F = SMD R1 = Tape & Reel (SMD Only) H = 5KV I/O BV

Part Number Example: AA36X-XX
 AA36F-R1 = Series 36, 6-Pin DIP, SMD style with tape and reel packaging

FEATURES

- **TOWARD** PhotoDMOS Relays
- 60 Volt, 2.5 Amp Hi-Current design
- On-Resistance: 0.07 Ω (typical)
- I/O Breakdown Voltage 3750 Vrms Min.
- Optional High I/O BV 5000 Vrms Min.
- Max LED Current 3.0 mA
- Low Off-State Leakage Current 1.0 μ A Max

SCHEMATIC

AA36(F)

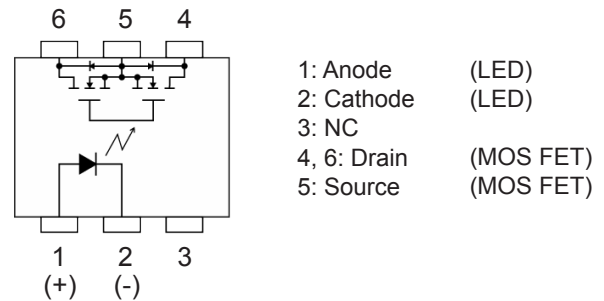

CONNECTION DIAGRAM

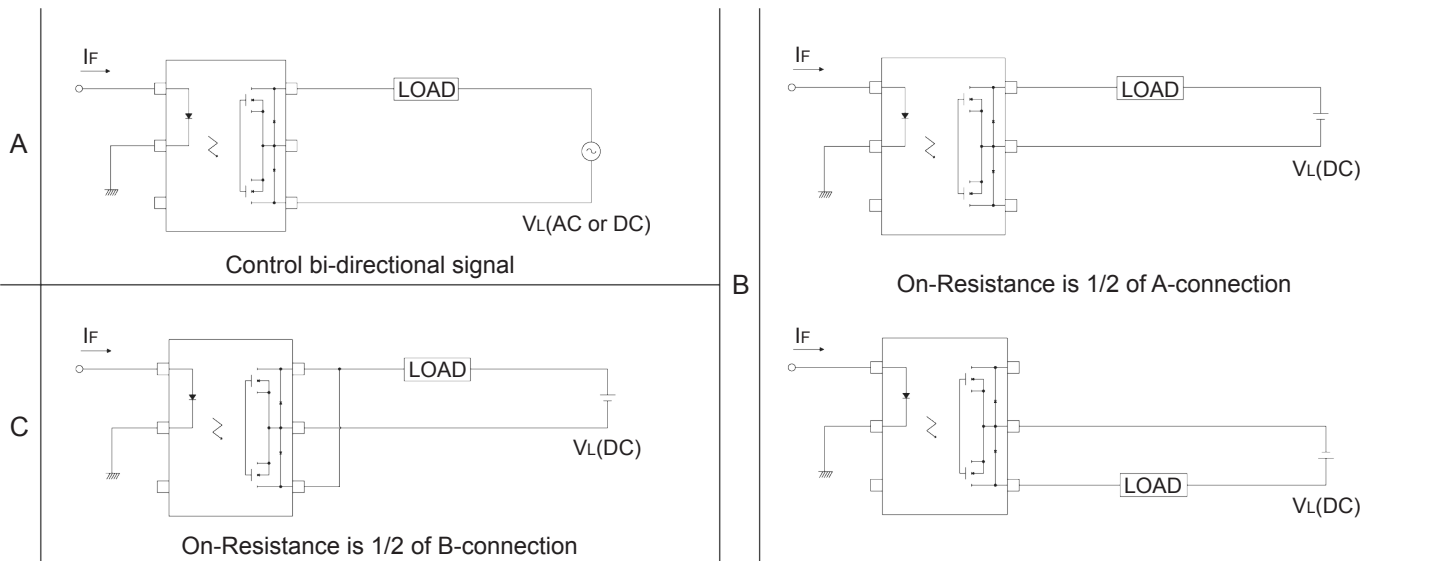

As part of the company policy of continued product improvement, specifications may change without notice. Our sales office will be pleased to help you with the latest information on this product range and the details of our full design and manufacturing service. All products are supplied to our standard conditions of sale unless otherwise agreed in writing.

Phone: (1) 973 777 6900

www.comus-intl.com

Fax: (1) 973 777 8405

Belgium: + 32 (0)12 390400 - Comus Europe Ltd (Assemtech) UK: +44 (0) 1255 862236 - Germany: +49 (0)911 923 15 943 - Netherlands: +31(0)45 54 39 345 - India: +(91) (44) 43219090

©2016 Copyright Comus International, 454 Allwood Road, Clifton NJ 07012, USA

Rev: 0 - Date: June/17/2016 - Signature: BR

An ISO 9001 Certified Company

Part Number: 36 Series
High Current - 1 Form A - PhotoDMOS Relays
Product Data Sheet

60 VOLTS

High Current up to 2.5A

ABSOLUTE MAXIMUM RATINGS (Ambient Temperature: 25°C)

ITEM		SYMBOL	VALUE	
Input	Continuous LED Current	I _F	50 mA	
	Peak LED Current (f=100 Hz, duty=1%)	I _{FP}	500 mA	
	LED Reverse Voltage	V _R	5 V	
	Input Power Dissipation	P _{In}	75 mW	
Output	Load Voltage	V _L	60 V (AC peak or DC)	
	Load Current (A)	I _L	A	2.5 A (AC or DC)
			B	3.5 A (DC)
			C	5.0 A (DC)
	Peak Load Current (1 ms, 1 shot) (A)	I _{Peak}	6.0 A	
Output Power Dissipation (mW)	P _{Out}	500 mW		
Total Power Dissipation (mW)		P _T	550 mW	
I/O Breakdown Voltage		V _{I/O}	3750 Vrms	
Operating Temperature		T _{Opr}	-40°C to +85°C	
Storage Temperature		T _{Stg}	-40°C to +100°C	

ELECTRICAL SPECIFICATIONS LED (Ambient Temperature: 25°C)

ITEM		SYMBOL	MIN	TYP	MAX	UNITS	CONDITIONS
Input	LED Forward Voltage	V _F	1.0		1.5	V	I _F = 10mA
	Operation LED Current	I _{F On}		1.5	3.0	mA	
	Recovery LED Voltage	V _{F Off}	0.5	1.0		V	
Output	On-Resistance Drain to Drain	R _{On}		0.07	0.14	Ω	I _F = 10mA I _L = Rating Time to flow is within 1 sec.
	Off-State Leakage Current	I _{Leak}			1.0	μA	I _F = 0mA, V _L = 50V
	Output Capacitance	C _{Out}		470		pF	V _L =0V, f=1MHz
Transmission	Turn-On Time	T _{On}		0.6	3.0	ms	I _F = 10mA, I _L = Rating
	Turn-Off Time	T _{Off}		0.04	0.5	ms	
Coupled	I/O Insulation Resistance	R _{I/O}	5*10 ⁹			Ω	
	I/O Capacitance	C _{I/O}		1.0		pF	f = 1MHz

As part of the company policy of continued product improvement, specifications may change without notice. Our sales office will be pleased to help you with the latest information on this product range and the details of our full design and manufacturing service. All products are supplied to our standard conditions of sale unless otherwise agreed in writing.

Phone: (1) 973 777 6900

www.comus-intl.com

Fax: (1) 973 777 8405

Belgium: + 32 (0)12 390400 - Comus Europe Ltd (Assemtech) UK: +44 (0) 1255 862236 - Germany: +49 (0)911 923 15 943 - Netherlands: +31(0)45 54 39 345 - India: +(91) (44) 43219090

©2016 Copyright Comus International, 454 Allwood Road, Clifton NJ 07012, USA

Rev: 0 - Date: June/17/2016 - Signature: BR

An ISO 9001 Certified Company

Part Number: 36 Series
High Current - 1 Form A - PhotoDMOS Relays
Product Data Sheet

60 VOLTS

High Current up to 2.5A

GRAPHS

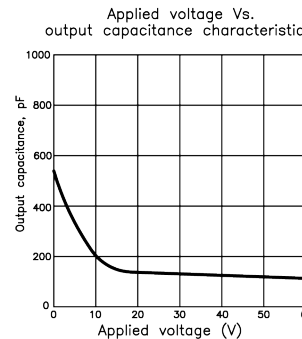
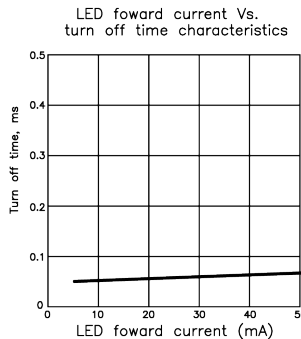
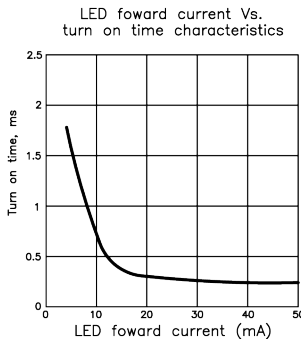
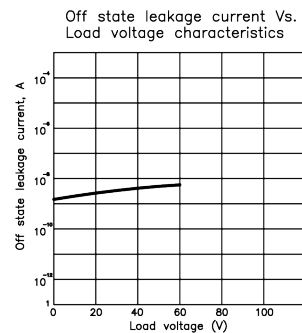
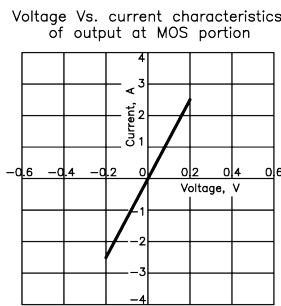
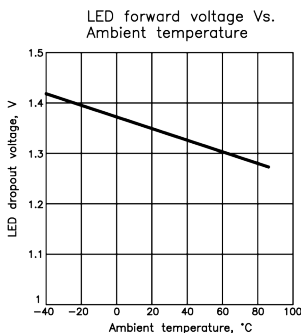
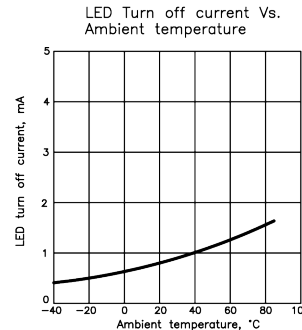
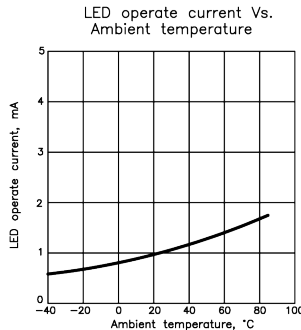
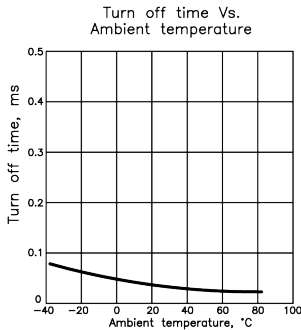
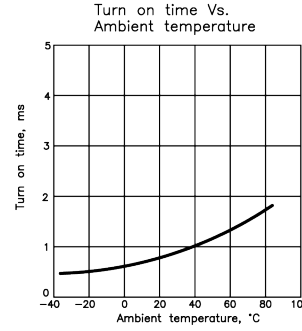
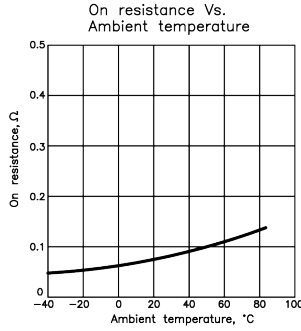
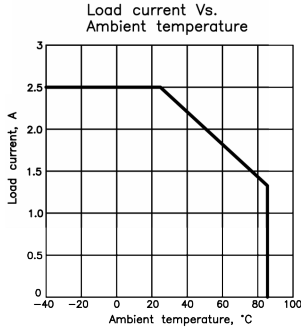

As part of the company policy of continued product improvement, specifications may change without notice. Our sales office will be pleased to help you with the latest information on this product range and the details of our full design and manufacturing service. All products are supplied to our standard conditions of sale unless otherwise agreed in writing.

Phone: (1) 973 777 6900

www.comus-intl.com

Fax: (1) 973 777 8405

Belgium: + 32 (0)12 390400 - Comus Europe Ltd (Assemtech) UK: +44 (0) 1255 862236 - Germany: +49 (0)911 923 15 943 - Netherlands: +31(0)45 54 39 345 - India: +(91) (44) 43219090

©2016 Copyright Comus International, 454 Allwood Road, Clifton NJ 07012, USA

Rev: 0 - Date: June/17/2016 - Signature: BR

An ISO 9001 Certified Company