

# PON Triplexer Control and Monitoring Circuit

## General Description

The DS1865 controls and monitors all the burst-mode transmitter and video receiver biasing functions for a passive optical network (PON) triplexer. It has an APC loop with tracking-error compensation that provides the reference for the laser driver bias current and a temperature-indexed lookup table (LUT) that controls the modulation current. It continually monitors for high output current, high bias current, and low and high transmit power with its internal fast comparators to ensure that laser shutdown for eye safety requirements are met without adding external components. Six ADC channels monitor  $V_{CC}$ , internal temperature, and four external monitor inputs (MON1–MON4) that can be used to meet transmitter and video receive signal monitoring requirements. Two digital-to-analog converter (DAC) outputs are available for biasing the video receiver channel, and five digital I/O pins are present to allow additional monitoring and configuration.

## Applications

Optical Triplexers with GEAPON, BPON, or GPON Transceiver

## Pin Configuration

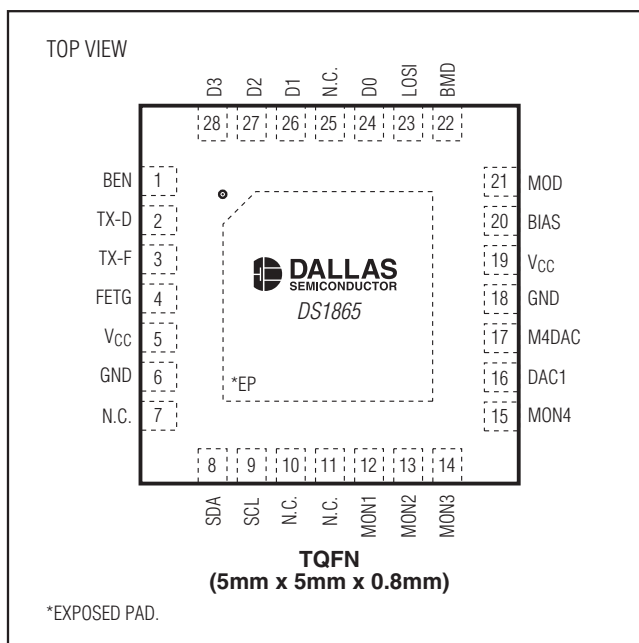

## Features

- ◆ Meets GEAPON, BPON, and GPON Timing Requirements for Burst-Mode Transmitters
- ◆ Bias Current Control Provided by APC Loop with Tracking-Error Compensation
- ◆ Modulation Current is Controlled by a Temperature-Indexed Lookup Table
- ◆ Laser Power Leveling from -6dB to +0dB
- ◆ Two 8-Bit Analog Outputs, One is Controlled by MON4 Voltage for Video Amplifier Gain Control
- ◆ Internal Direct-to-Digital Temperature Sensor
- ◆ Six Analog Monitor Channels: Temperature,  $V_{CC}$ , MON1, MON2, MON3, and MON4
- ◆ Five Digital I/O Pins for Additional Control and Monitoring Functions
- ◆ Comprehensive Fault Management System with Maskable Laser Shutdown Capability
- ◆ Two-Level Password Access to Protect Calibration Data
- ◆ 120 Bytes of Password 1 Protected Nonvolatile Memory
- ◆ 128 Bytes of Password 2 Protected Nonvolatile Memory in Main Device Address
- ◆ 128 Bytes of Nonvolatile Memory Located at A0h Slave Address
- ◆ I<sup>2</sup>C-Compatible Interface for Calibration and Monitoring
- ◆ Operating Voltage: 2.85V to 3.9V
- ◆ Operating Temperature Range: -40°C to +95°C
- ◆ Packaging: 28-Pin Lead-Free TQFN (5mm x 5mm x 0.8mm)

## Ordering Information

PART	TEMP RANGE	PIN-PACKAGE
DS1865T+	-40°C to +95°C	28 TQFN-EP*
DS1865T+T&R	-40°C to +95°C	28 TQFN-EP*

+Denotes a lead(Pb)-free/RoHS-compliant package.

\*EP = Exposed pad.

T&R = Tape and reel.

# PON Triplexer Control and Monitoring Circuit

## ABSOLUTE MAXIMUM RATINGS

Voltage Range on MON1–MON4, BEN, BMD, and TX-D Pins Relative to Ground .....-0.5V to ( $V_{CC} + 0.5V$ )  
(subject to not exceeding +6V)  
Voltage Range on  $V_{CC}$ , SDA, SCL, D0–D3, and TX-F Pins Relative to Ground .....-0.5V to +6V

Operating Temperature Range .....-40°C to +95°C  
Programming Temperature Range .....0°C to +70°C  
Storage Temperature Range .....-55°C to +125°C  
Soldering Temperature.....See J-STD-020 Specification

Stresses beyond those listed under "Absolute Maximum Ratings" may cause permanent damage to the device. These are stress ratings only, and functional operation of the device at these or any other conditions beyond those indicated in the operational sections of the specifications is not implied. Exposure to absolute maximum rating conditions for extended periods may affect device reliability.

## RECOMMENDED OPERATING CONDITIONS

( $T_A = -40^\circ\text{C}$  to  $+95^\circ\text{C}$ , unless otherwise noted.)

PARAMETER	SYMBOL	CONDITIONS	MIN	TYP	MAX	UNITS
Supply Voltage	$V_{CC}$	(Note 1)	+2.85		+3.9	V
High-Level Input Voltage (SDA, SCL, BEN)	$V_{IH:1}$		$0.7 \times V_{CC}$		$V_{CC} + 0.3$	V
Low-Level Input Voltage (SDA, SCL, BEN)	$V_{IL:1}$		-0.3		$0.3 \times V_{CC}$	V
High-Level Input Voltage (TX-D, LOSI, D0, D1, D2, D3)	$V_{IH:2}$		2.0		$V_{CC} + 0.3$	V
Low-Level Input Voltage (TX-D, LOSI, D0, D1, D2, D3)	$V_{IL:2}$		-0.3		0.8	V

## DC ELECTRICAL CHARACTERISTICS

( $V_{CC} = +2.85V$  to  $+3.9V$ ,  $T_A = -40^\circ\text{C}$  to  $+95^\circ\text{C}$ , unless otherwise noted.)

PARAMETER	SYMBOL	CONDITIONS	MIN	TYP	MAX	UNITS
Supply Current	$I_{CC}$	(Notes 1, 2)		5	10	mA
Output Leakage (SDA, TX-F, D0, D1, D2, D3)	$I_{LO}$				1	$\mu\text{A}$
Low-Level Output Voltage (SDA, TX-F, FETG, D0, D1, D2, D3)	$V_{OL}$	$I_{OL} = 4\text{mA}$			0.4	V
		$I_{OL} = 6\text{mA}$			0.6	
High-Level Output Voltage (FETG)	$V_{OH}$	$I_{OH} = 4\text{mA}$	$V_{CC} - 0.4$			V
FETG Before Recall		(Note 3)		10	100	nA
Input-Leakage Current (SCL, BEN, TX-D, LOSI)	$I_{LI}$				1	$\mu\text{A}$
Digital Power-On Reset	POD		1.0		2.2	V
Analog Power-On Reset	POA		2.1		2.75	V

# PON Triplexer Control and Monitoring Circuit

DS1865

## ELECTRICAL CHARACTERISTICS (DAC1 and M4DAC)

( $V_{CC} = +2.85V$  to  $+3.9V$ ,  $T_A = -40^{\circ}C$  to  $+95^{\circ}C$ , unless otherwise noted.)

PARAMETER	SYMBOL	CONDITIONS	MIN	TYP	MAX	UNITS
DAC Output Range			0		2.5	V
DAC Output Resolution				8		Bits
DAC Output Integral Nonlinearity			-2		+2	LSB
DAC Output Differential Nonlinearity			-1		+1	LSB
DAC Error		$T_A = +25^{\circ}C$	-1.25		+1.25	LSB
DAC Temperature Drift			-2		+2	% FS
DAC Offset		$V_{CC} = 2.85V$ to $3.6V$	-20		+20	$\mu V$
Maximum Load			-500		+500	$\mu A$
Maximum Load Capacitance					250	pF

## ANALOG INPUT CHARACTERISTICS (BMD, TXP-HI, TXP-LO, HBIAS)

( $V_{CC} = +2.85V$  to  $+3.9V$ ,  $T_A = -40^{\circ}C$  to  $+95^{\circ}C$ , unless otherwise noted.)

PARAMETER	SYMBOL	CONDITIONS	MIN	TYP	MAX	UNITS
BMD, TXP-HI, TXP-LO Full-Scale Voltage	$V_{APC}$	(Note 4)		2.5		V
HBIAS Full-Scale Voltage				1.25		mA
BMD Input Resistance			35	50	65	$k\Omega$
Resolution		(Note 4)		8		Bits
Error		$T_A = +25^{\circ}C$ (Note 5)		$\pm 2$		%FS
Integral Nonlinearity			-1		+1	LSB
Differential Nonlinearity			-1		+1	LSB
Temperature Drift			-2.5		+2.5	%FS

## ANALOG OUTPUT CHARACTERISTICS

( $V_{CC} = +2.85V$  to  $+3.9V$ ,  $T_A = -40^{\circ}C$  to  $+95^{\circ}C$ , unless otherwise noted.)

PARAMETER	SYMBOL	CONDITIONS	MIN	TYP	MAX	UNITS
BIAS Current	$I_{BIAS}$	(Note 1)		1.2		mA
$I_{BIAS}$ Shutdown Current	$I_{BIAS:OFF}$			10	100	nA
Voltage at $I_{BIAS}$			0.7	1.2	1.4	V
MOD Full-Scale Voltage	$V_{MOD}$	(Note 6)		1.25		V
MOD Output Impedance		(Note 7)		3		$k\Omega$
$V_{MOD}$ Error		$T_A = +25^{\circ}C$ (Note 8)	-2.5		+2.5	%FS
$V_{MOD}$ Integral Nonlinearity			-3		+3	LSB
$V_{MOD}$ Differential Nonlinearity			-1		+1	LSB
$V_{MOD}$ Temperature Drift			-2		+2	%FS

# PON Triplexer Control and Monitoring Circuit

## ANALOG VOLTAGE MONITORING

( $V_{CC} = +2.85V$  to  $+3.9V$ ,  $T_A = -40^{\circ}C$  to  $+95^{\circ}C$ , unless otherwise noted.)

PARAMETER		SYMBOL	CONDITIONS	MIN	TYP	MAX	UNITS
Input Resolution		$\Delta V_{MON}$			610		$\mu V$
Supply Resolution		$\Delta V_{CC}$			1.6		mV
Input/Supply Accuracy (MON1, MON2, MON3, MON4, $V_{CC}$ )		ACC	At factory setting		0.25	0.5	% FS (full scale)
Update Rate for MON1, MON2, MON3, MON4 Temp, or $V_{CC}$		$t_{FRAME}$			30	45	ms
Input/Supply Offset (MON1, MON2, MON3, MON4, $V_{CC}$ )		$V_{OS}$	(Note 14)		0	5	LSB
Factory Setting	MON1, MON2, MON3, MON4				2.5		V
	$V_{CC}$				6.5536		

## DIGITAL THERMOMETER

( $V_{CC} = +2.85V$  to  $+3.9V$ ,  $T_A = -40^{\circ}C$  to  $+95^{\circ}C$ , unless otherwise noted.)

PARAMETER	SYMBOL	CONDITIONS	MIN	TYP	MAX	UNITS
Thermometer Error	$T_{ERR}$	$-40^{\circ}C$ to $+95^{\circ}C$			$\pm 3.0$	$^{\circ}C$

## TIMING CHARACTERISTICS (CONTROL LOOP AND QUICK-TRIP)

( $V_{CC} = +2.85V$  to  $+3.9V$ ,  $T_A = -40^{\circ}C$  to  $+95^{\circ}C$ , unless otherwise noted.)

PARAMETER	SYMBOL	CONDITIONS	MIN	TYP	MAX	UNITS
First MD Sample Following BEN	$t_{FIRST}$	(Note 9)				
Remaining Updates During BEN	$t_{UPDATE}$	(Note 9)				
BEN High Time	$t_{BEN:HIGH}$		400			ns
BEN Low Time	$t_{BEN:LOW}$		96			ns
Output-Enable Time Following POA	$t_{INIT}$		10			ms
BIAS and MOD Turn-Off Delay	$t_{OFF}$				5	$\mu s$
BIAS and MOD Turn-On Delay	$t_{ON}$				5	$\mu s$
FETG Turn-On Delay	$t_{FETG:ON}$				5	$\mu s$
FETG Turn-Off Delay	$t_{FETG:OFF}$				5	$\mu s$
Binary Search Time	$t_{SEARCH}$	(Note 10)	5		13	BIAS Samples
ADC Round-Robin Time	$t_{RR}$				75	ms

# PON Triplexer Control and Monitoring Circuit

DS1865

## I<sup>2</sup>C AC ELECTRICAL CHARACTERISTICS

(V<sub>CC</sub> = +2.85V to +3.9V, T<sub>A</sub> = -40°C to +95°C, timing referenced to V<sub>IL(MAX)</sub> and V<sub>IH(MIN)</sub>.) (See Figure 9.)

PARAMETER	SYMBOL	CONDITIONS	MIN	TYP	MAX	UNITS
SCL Clock Frequency	f <sub>SCL</sub>	(Note 11)	0		400	kHz
Clock Pulse-Width Low	t <sub>LOW</sub>		1.3			μs
Clock Pulse-Width High	t <sub>HIGH</sub>		0.6			μs
Bus-Free Time Between STOP and START Condition	t <sub>BUF</sub>		1.3			μs
Start Hold Time	t <sub>HD:STA</sub>		0.6			μs
Start Setup Time	t <sub>SU:STA</sub>		0.6			μs
Data in Hold Time	t <sub>HD:DAT</sub>		0		0.9	μs
Data in Setup Time	t <sub>SU:DAT</sub>		100			ns
Rise Time of Both SDA and SCL Signals	t <sub>R</sub>	(Note 12)	20 + 0.1C <sub>B</sub>		300	ns
Fall Time of Both SDA and SCL Signals	t <sub>F</sub>	(Note 12)	20 + 0.1C <sub>B</sub>		300	ns
STOP Setup Time	t <sub>SU:STO</sub>		0.6			μs
Capacitive Load for Each Bus Line	C <sub>B</sub>	(Note 12)			400	pF
EEPROM Write Time	t <sub>W</sub>	(Note 13)			20	ms

## NONVOLATILE MEMORY CHARACTERISTICS

(V<sub>CC</sub> = +2.85V to +3.9V)

PARAMETER	SYMBOL	CONDITIONS	MIN	TYP	MAX	UNITS
EEPROM Write Cycles		At +70°C	50,000			

- Note 1:** All voltages are referenced to ground. Current into IC is positive, out of the IC is negative.
- Note 2:** Digital inputs are at rail. FETG is disconnected. SDA = SCL = V<sub>CC</sub>. DAC1 and M4DAC are not loaded.
- Note 3:** See the *Safety Shutdown (FETG) Output* section for details.
- Note 4:** Eight ranges allow the full-scale range to change from 625mV to 2.5V.
- Note 5:** This specification applies to the expected full-scale value for the selected range. See the Comp Ranging byte for available full-scale ranges.
- Note 6:** Eight ranges allow the BMD full-scale range to change from 312.5mV to 1.25V.
- Note 7:** The output impedance of the DS1865 is proportional to its scale setting. For instance, if using the 1/2 scale, the output impedance would be approximately 1.56kΩ.
- Note 8:** This specification applies to the expected full-scale value for the selected range. See the Mod Ranging byte for available full-scale ranges.
- Note 9:** See the *APC and Quick-Trip Shared Comparator Timing* section for details.
- Note 10:** Assuming an appropriate initial step is programmed that would cause the power to exceed the APC set point within four steps, the bias current will be 1% within the time specified by the binary search time. See the *Bias and MOD Output During Power-Up* section.
- Note 11:** I<sup>2</sup>C interface timing shown is for fast-mode (400kHz) operation. This device is also backward-compatible with the I<sup>2</sup>C standard mode.
- Note 12:** C<sub>B</sub>—total capacitance of one bus line in picofarads.
- Note 13:** EEPROM write begins after a STOP condition occurs.
- Note 14:** Guaranteed by design.

# PON Triplexer Control and Monitoring Circuit

## Typical Operating Characteristics

( $V_{CC} = 3.3V$ ,  $T_A = +25^\circ C$ , unless otherwise noted.)

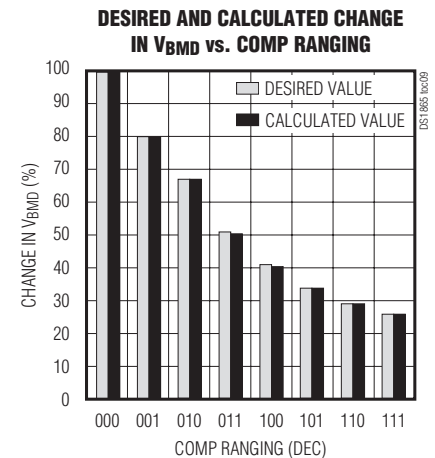
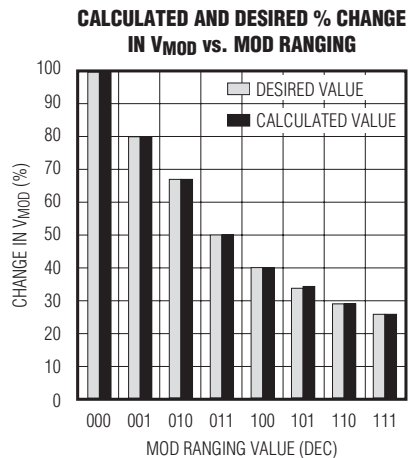
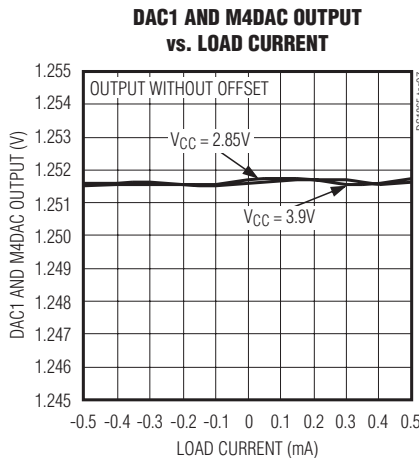
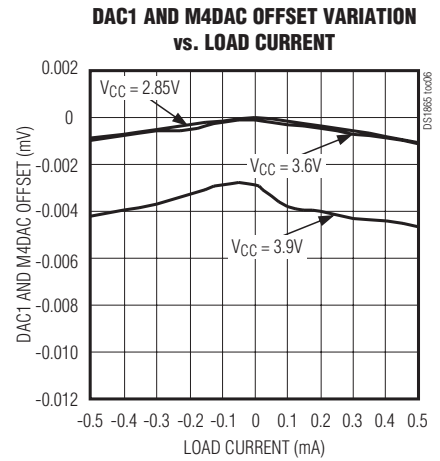
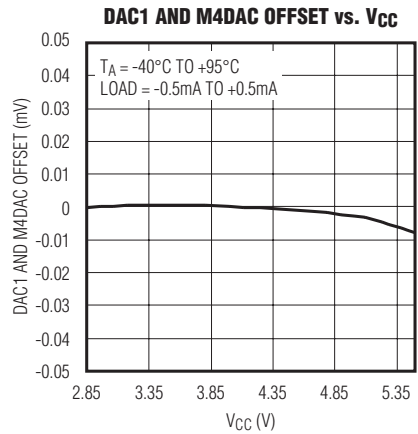
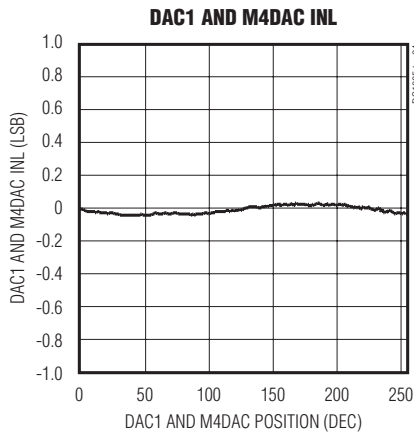
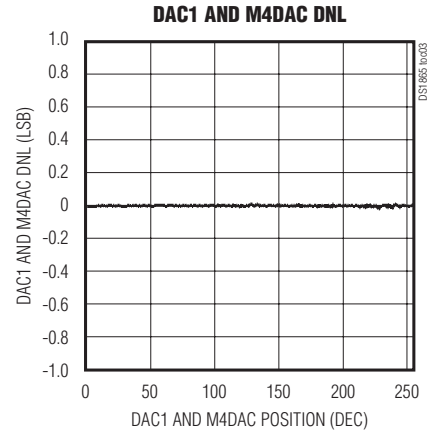
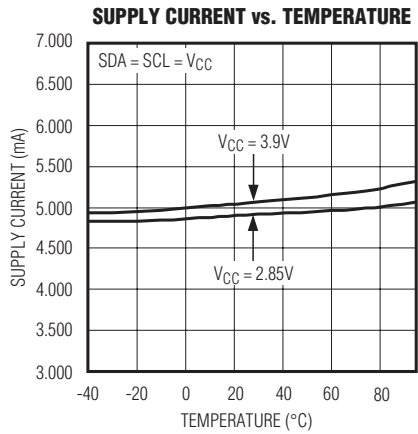
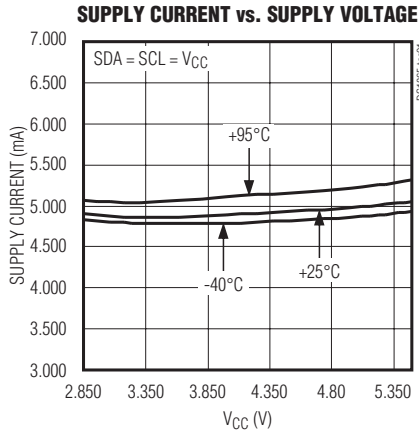

# PON Triplexer Control and Monitoring Circuit

DS1865

## Typical Operating Characteristics (continued)

( $V_{CC} = 3.3V$ ,  $T_A = +25^\circ C$ , unless otherwise noted.)

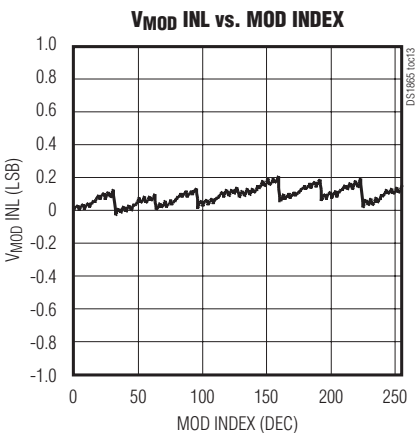
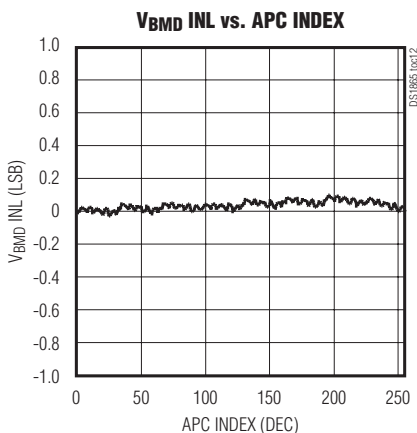
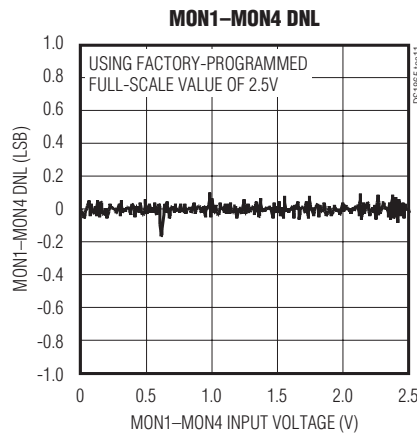
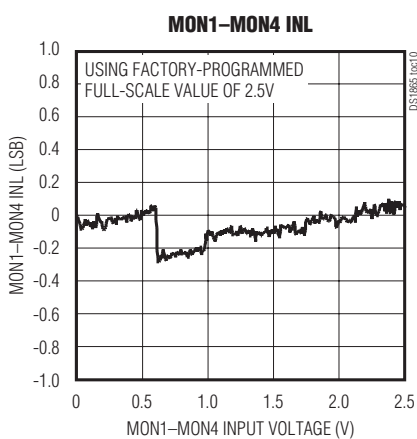

# PON Triplexer Control and Monitoring Circuit

## Pin Description

PIN	NAME	FUNCTION
1	BEN	Burst Enable Input. Triggers the sampling of the APC and quick-trip monitors.
2	TX-D	Transmit Disable Input. Disables BIAS and MOD outputs.
3	TX-F	Transmit Fault Output, Open Drain
4	FETG	Output to FET Gate. Signals an external n- or p-channel MOSFET to enable/disable the laser's current.
5, 19	VCC	Supply Voltage
6, 18	GND	Ground
7, 10, 11, 25	N.C.	No Connection
8	SDA	I <sup>2</sup> C Serial Data. Input/output for I <sup>2</sup> C data.
9	SCL	I <sup>2</sup> C Serial Clock. Input for I <sup>2</sup> C clock.
12–15	MON1–MON4	External Monitor Input 1–4. The voltage at these pins are digitized by the internal analog-to-digital converter and can be read through the I <sup>2</sup> C interface. Alarm and warning values can be assigned to interrupt the processor based on the ADC result.
16	DAC1	Digital-to-Analog Output DAC1 and M4DAC. Two 8-bit DAC outputs for generating analog voltages. Typically used to control the video photodiode bias. M4DAC is controlled by the input voltage on MON4 and Table 06h LUT.
17	M4DAC	
20	BIAS	Bias Current Output. This current DAC generates the bias current reference for the MAX3643.
21	MOD	Modulation Output Voltage. This 8-bit voltage output has eight full-scale ranges from 1.25V to 0.3125V. This pin is connected to the MAX3643's VMSET input to control the modulation current.
22	BMD	Monitor Diode Input (Feedback Voltage, Transmit Power Monitor)
23	LOSI	Loss-of-Signal Input. This input is accessible in the status register through the I <sup>2</sup> C interface.
24	D0	Digital I/O 0. This signal is either the open-drain output driver for LOSI, or can be controlled by the OUT0 bit (D0OUT). The logic level of this pin is indicated by the D0IN and LOS status bits.
26, 27, 28	D1, D2, D3	Digital I/O 1–3. These are bidirectional pins controlled by internally addressable bits. The outputs are open-drain.
—	EP	Exposed Pad. This contact should be connected to GND.



# PON Triplexer Control and Monitoring Circuit

## Block Diagram

DS1865

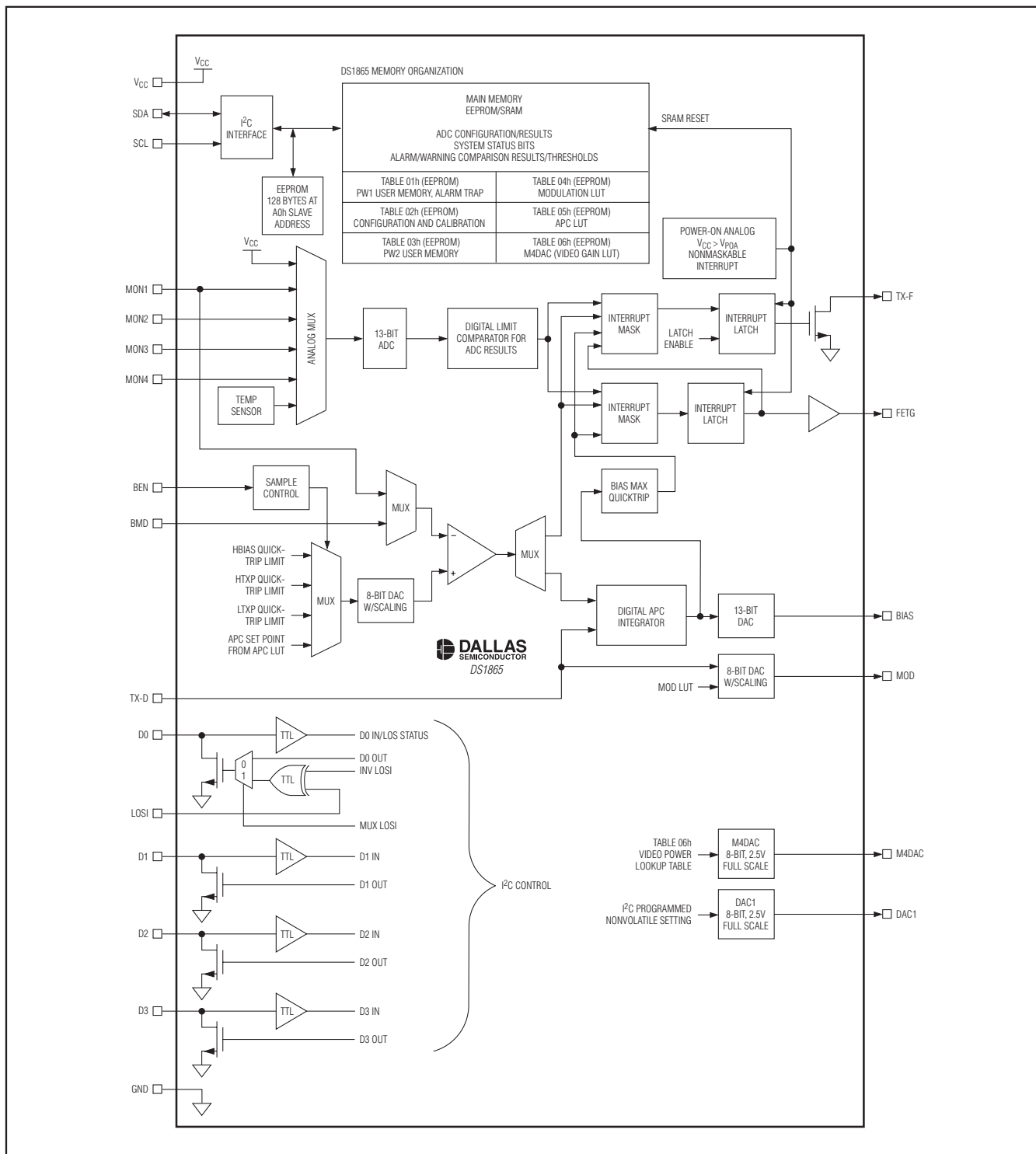

# PON Triplexer Control and Monitoring Circuit

## Typical Operating Circuit

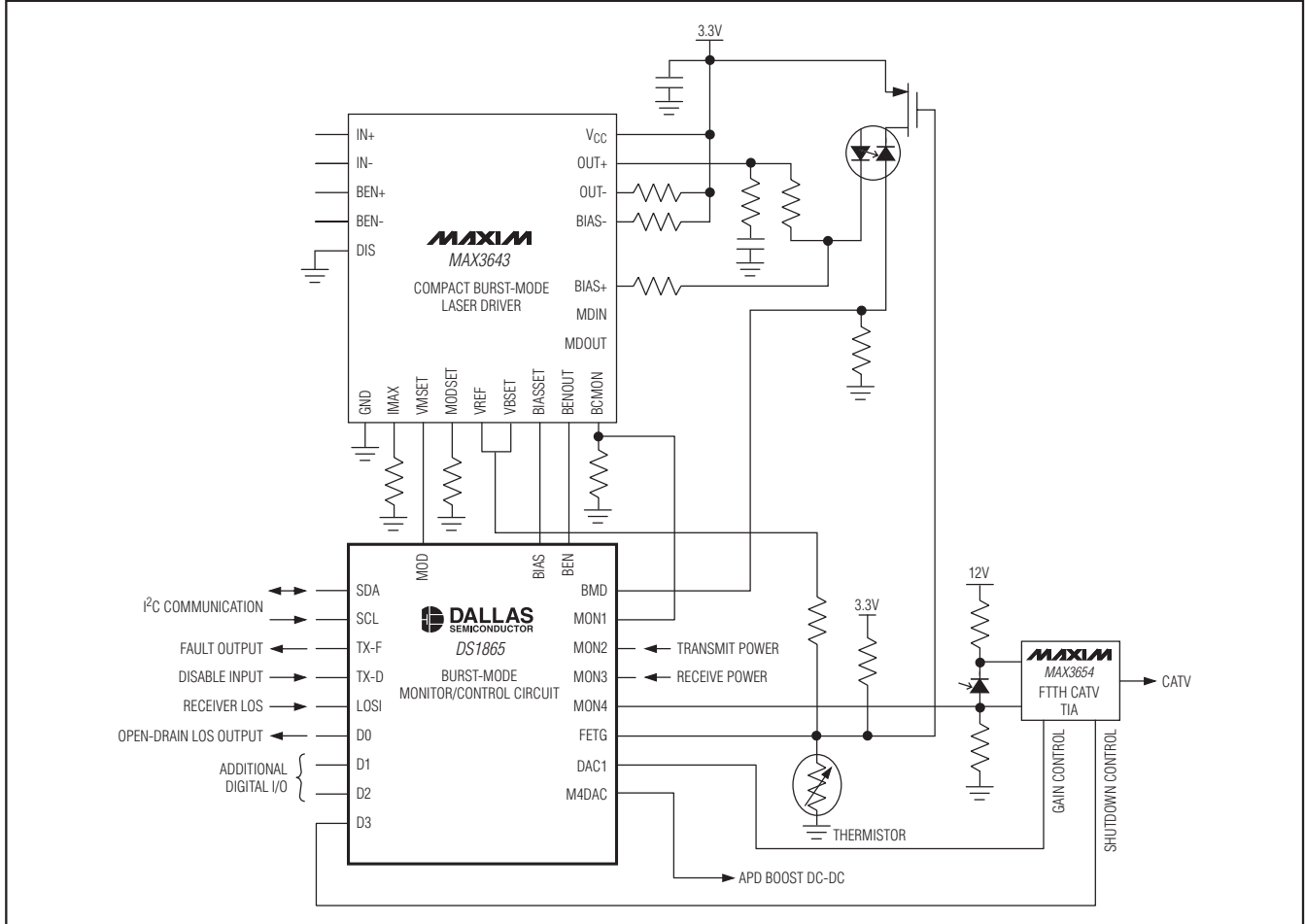

### Detailed Description

The DS1865 integrates the control and monitoring functionality required to implement a PON system using Maxim’s MAX3643 compact burst-mode laser driver. The compact laser driver solution offers a considerable cost benefit by integrating control and monitoring features in the low-power CMOS process, while leaving only the high-speed portions to the laser driver. Key components of the DS1865 are shown in the *Block Diagram* and described in subsequent sections. Table 1 contains a list of acronyms used in this data sheet.

#### APC Control

BIAS current is controlled by an average power control (APC) loop. The APC loop uses digital techniques to overcome the difficulties associated with controlling burst-mode systems.

**Table 1. Acronyms**

ACRONYM	DEFINITION
ADC	Analog-to-Digital Converter
APC	Average Power Control
ATB	Alarm Trap Bytes
DAC	Digital-to-Analog Converter
LUT	Lookup Table
NV	Nonvolatile
PON	Passive Optical Network
QT	Quick Trip
SEE	Shadowed EEPROM
TE	Tracking Error
TXP	Transmit Power

# PON Triplexer Control and Monitoring Circuit

The APC loop's feedback is the monitor diode (BMD) current, which is converted to a voltage using an external resistor. The feedback voltage is compared to an 8-bit scaleable voltage reference that determines the APC set point of the system. Scaling of the reference voltage accommodates the wide range in photodiode sensitivities. This allows the application to take full advantage of the APC reference's resolution.

The DS1865 has an LUT to allow the APC set point to change as a function of temperature to compensate for tracking error (TE). The TE LUT (Table 05h) has 36 entries that determine the APC setting in 4°C windows between -40°C to +100°C. Ranging of the APC DAC is possible by programming a single byte in Table 02h.

## Modulation Control

The MOD output is an 8-bit scaleable voltage output that interfaces with the MAX3643's VMSET input. An external resistor to ground from the MAX3643's MODSET pin sets the maximum current the voltage at VMSET input can produce for a given output range. This resistor value should be chosen to produce the maximum modulation current the laser type requires over temperature. Then the MOD output's scaling is used to calibrate the full-scale (FS) modulation output to a particular laser's requirements. This allows the application to take full advantage of the MOD output's resolution. The modulation LUT can be programmed in 2°C increments over the -40°C to +102°C range.

Ranging of the MOD DAC is possible by programming a single byte in Table 02h.

## BIAS and MOD Output During Power-Up

On power-up, the modulation and bias outputs remain off until  $V_{CC}$  is above  $V_{POA}$  and a temperature conversion has been completed. If the  $V_{CC}$  LO ADC alarm is enabled, then a  $V_{CC}$  conversion above the customer-defined  $V_{CC}$  low alarm level is required before the outputs are enabled with the value determined by the temperature conversion and the modulation LUT.

When the MOD output is enabled and BEN is high, the BIAS output is turned on to a value equal to ISTEP (see Figure 1). The startup algorithm checks if this bias current causes a feedback voltage above the APC set point, and if it does not it continues increasing the BIAS by ISTEP until the APC set point is exceeded. When the APC set point is exceeded, the DS1865 begins a binary search to quickly reach the bias current corresponding to the proper power level. After the binary search is completed the APC integrator is enabled, and single LSB steps are taken to tightly control the average power.

All quick-trip alarm flags are masked until the binary search is completed. However, the BIAS MAX alarm is monitored during this time to prevent the bias output from exceeding MAX IBIAS. During the bias current initialization, the bias current is not allowed to exceed MAX IBIAS. If this occurs during the ISTEP sequence, the binary search routine begins. If MAX IBIAS is exceeded during the binary search, the next smaller step is activated. ISTEP or binary increments that would cause IBIAS to exceed MAX IBIAS are not taken. Masking the alarms until the completion of the binary search prevents false trips during startup.

ISTEP is programmed by the customer using the Startup Step register. This value should be programmed to the maximum safe current increase that is allowable during startup. If this value is programmed too low, the DS1865 will still operate, but it could take significantly longer for the algorithm to converge and hence to control the average power.

If a fault is detected and TX-D is toggled to re-enable the outputs, the DS1865 powers up following a similar sequence to an initial power-up. The only difference is that the DS1865 already has determined the present temperature, so the  $t_{INIT}$  time is not required for the DS1865 to recall the APC and MOD set points from EEPROM.

If the Bias-En bit (Table 02h, Register 80h) is written to 0, the BIAS DAC is manually controlled by the MAN IBIAS register (Table 02h, Registers F8h–F9h).

## BIAS and MOD Output as a Function of Transmit Disable (TX-D)

If the TX-D pin is asserted (logic 1) during normal operation, the outputs are disabled within  $t_{OFF}$ . When TX-D is deasserted (logic 0), the DS1865 turns on the MOD output with the value associated with the present temperature, and initializes the BIAS using the same search algorithm used at startup. When asserted, the soft TX-D (Lower Memory, Register 6Eh) offers a software control identical to the TX-D pin (see Figure 2).

## APC and Quick-Trip Shared Comparator Timing

As shown in Figure 3, the DS1865's input comparator is shared between the APC control loop and the three quick-trip alarms (TXP-HI, TXP-LO, and BIAS HI). The comparator polls the alarms in a round-robin multiplexed sequence. Six of every eight comparator readings are used for APC loop-bias current control. The other two updates are used to check the HTPX/LTXP (monitor diode voltage) and the HBIAS (MON1) signals against the internal APC and BIAS reference. The HTPX/LTXP comparison checks HTPX to see if the last

# PON Triplexer Control and Monitoring Circuit

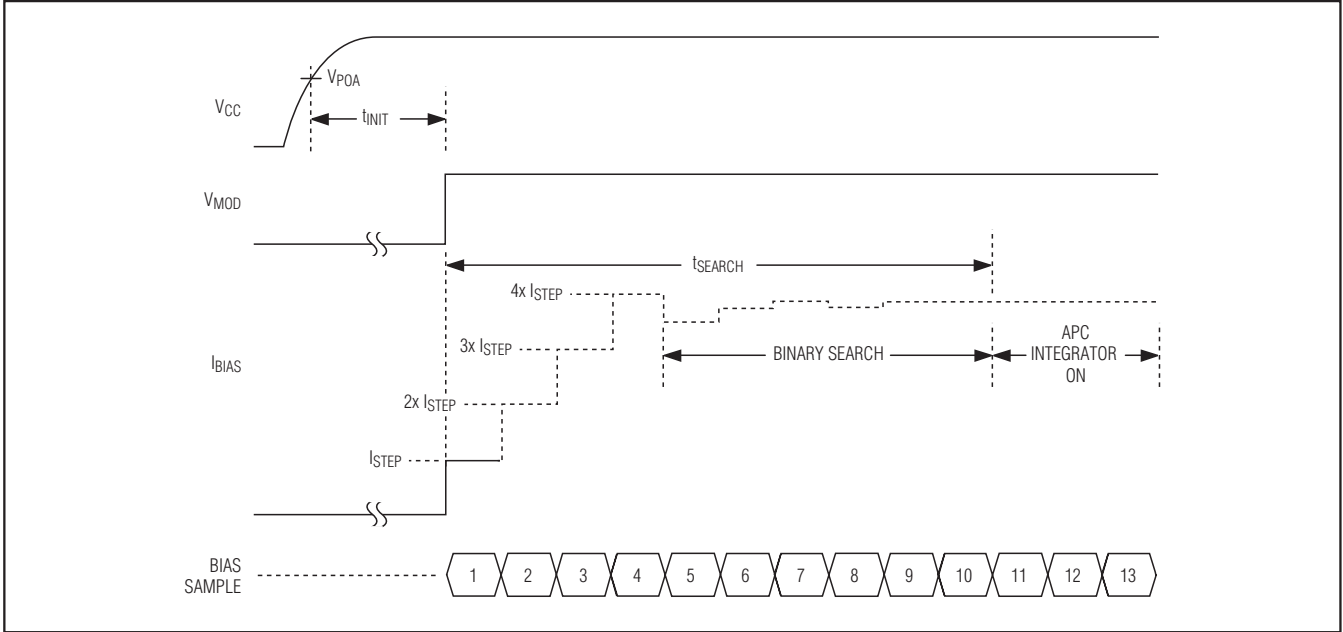

Figure 1. Power-Up Timing

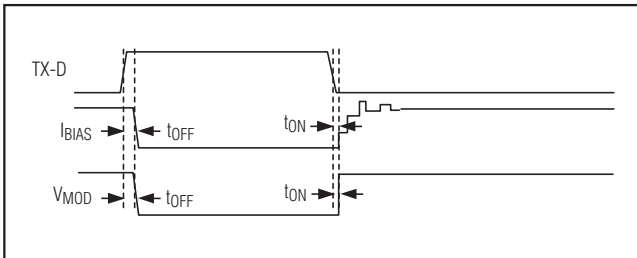

Figure 2. TX-D Timing (Normal Operating Conditions)

bias update comparison was above the APC set point, and checks LTXP to see if the last bias update comparison was below the APC set point. Depending on the results of the comparison, the corresponding alarms and warnings (TXP-HI, TXP-LO) are asserted or deasserted.

The DS1865 has a programmable comparator sample time based on an internally generated clock to facilitate a wide variety of external filtering options suitable for burst-mode transmitter data rates between 155Mbps and 1250Mbps. The rising edge of the burst enable (BEN) triggers the sample to occur, and the Update Rate register (Table 02h, Register 88h) determines the sampling time. The first sample occurs  $t_{FIRST}$  after the rising

edge of BEN. The internal clock is asynchronous to BEN, causing a  $\pm 50ns$  uncertainty regarding when the first sample will occur following BEN. After the first sample occurs, subsequent samples occur on a regular interval,  $t_{REP}$ . Table 2 shows the sample rate options available.

Table 2. Update Rate Timing

SR <sub>3</sub> -SR <sub>0</sub>	MINIMUM TIME FROM BEN TO FIRST SAMPLE ( $t_{FIRST}$ ) $\pm 50ns$	REPEATED SAMPLE PERIOD FOLLOWING FIRST SAMPLE ( $t_{REP}$ )
0000b	350ns	800ns
0001b	550ns	1200ns
0010b	750ns	1600ns
0011b	950ns	2000ns
0100b	1350ns	2800ns
0101b	1550ns	3200ns
0110b	1750ns	3600ns
0111b	2150ns	4400ns
1000b	2950ns	6000ns
1001b*	3150ns	6400ns

\*All codes greater than 1001b (1010b-1111b) use the maximum sample time of code 1001b.

# PON Triplexer Control and Monitoring Circuit

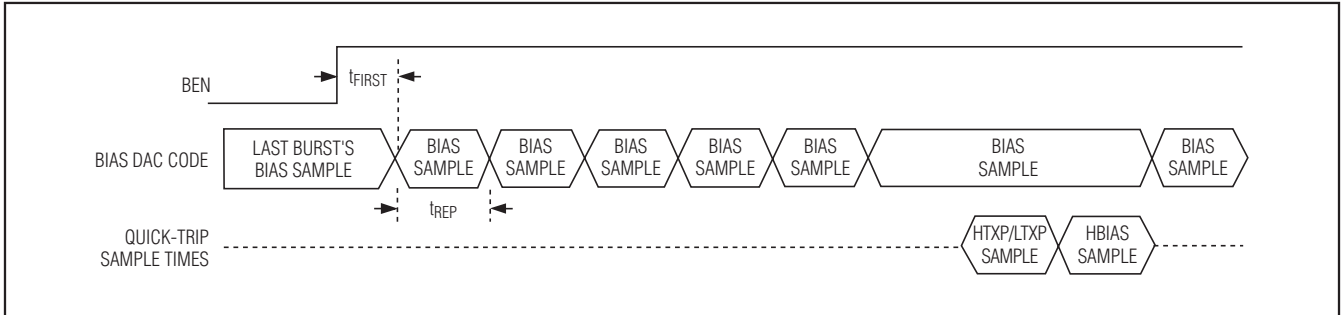

Figure 3. APC and Quick-Trip Alarm Sample Timing

Updates to the TXP-HI, TXP-LO, and BIAS HI quick-trip alarms do not occur during the burst-enable low time. Any quick-trip alarm that is detected by default remains active until a subsequent comparator sample shows the condition no longer exists.

A second bias-current monitor (BIAS MAX) compares the DS1865's BIAS DAC's code to a digital value stored in the MAX IBIAS register. This comparison is made every bias-current update to ensure that a high bias current is quickly detected.

## Monitors and Fault Detection

### Monitors

Monitoring functions on the DS1865 include four quick-trip comparators and six ADC channels. This monitoring, combined with the interrupt masks, determines when/if the DS1865 shuts down its outputs and triggers the TX-F and FETG outputs. All the monitoring levels and interrupt masks are user programmable.

### Four Quick-Trip Monitors and Alarms

Four quick-trip monitors are provided to detect potential laser safety issues. These monitor:

- 1) High Bias Current (HBIAS)
- 2) Low Transmit Power (LTXP)
- 3) High Transmit Power (HTXP)
- 4) Max Output Current (MAX IBIAS)

The high and low transmit power quick-trip registers (HTXP and LTXP) set the thresholds used to compare against the BMD voltage to determine if the transmit power is within specification. The HBIAS quick-trip compares the MON1 input (generally from the MAX3643 bias monitor output) against its threshold setting to determine if the present bias current is above specification. The BIAS MAX quick-trip is a digital comparison that determines if the BIAS DAC indicates that the bias

current is above specification. I<sub>BIAS</sub> is not allowed to exceed the value set in the MAX IBIAS register. When the DS1865 detects that the bias is at the limit, it sets the BIAS MAX status bit and holds the bias current at the MAX IBIAS level. The quick-trips are routed to the TX-F and FETG outputs through interrupt masks to allow combinations of these alarms to be used to trigger these outputs. When FETG is triggered, the DS1865 also disables the MOD and BIAS outputs. See the *BIAS and MOD Output During Power-Up* section for details.

### Six ADC Monitors And Alarms

The ADC monitors six channels that measure temperature (internal temp sensor), V<sub>CC</sub>, MON1, MON2, MON3, and MON4 using an analog multiplexer to measure them round-robin with a single ADC. Each channel has a customer-programmable full-scale range and offset value that is factory programmed to a default value (see Table 3). Additionally, MON1–MON4 can right shift results by up to 7 bits before the results are compared to alarm thresholds or read over the I<sup>2</sup>C bus. This allows customers with specified ADC ranges to calibrate the ADC full scale to a factor of 1/2<sup>n</sup> of their specified range to measure small signals. The DS1865 can then right shift the results by n bits to maintain the bit weight of their specification.

Table 3. ADC Default Monitor Full-Scale Ranges

SIGNAL (UNITS)	+FS SIGNAL	+FS HEX	-FS SIGNAL	-FS HEX
Temperature (°C)	127.996	7FFF	-128	8000
V <sub>CC</sub> (V)	6.5528	FFF8	0V	0000
MON1–MON4 (V)	2.4997	FFF8	0V	0000

# PON Triplexer Control and Monitoring Circuit

The ADC results (after right shifting, if used) are compared to high alarm thresholds, low alarm thresholds, and the warning threshold after each conversion, and the corresponding alarms are set, which can be used to trigger the TX-F or FETG outputs. These ADC thresholds are user programmable, as are the masking registers that can be used to prevent the alarms from triggering the TX-F and FETG outputs.

## ADC Timing

There are six analog channels that are digitized in a round-robin fashion in the order as shown in Figure 4. The total time required to convert all six channels is  $t_{RR}$  (see *Timing Characteristics (Control Loop and Quick-Trip)* for details).

## Right Shifting ADC Result

If the weighting of the ADC digital reading must conform to a predetermined full-scale value defined by a standard's specification, then right shifting can be used to adjust the predetermined full-scale analog measurement range while maintaining the weighting of the ADC results. The DS1865's range is wide enough to cover all requirements; when the maximum input value is far short of the FS value, right shifting can be used to obtain greater accuracy. For instance, the maximum voltage might be 1/8th the specified predetermined full-scale value, so only 1/8th the converter's range is used. An alternative is to calibrate the ADC's full-scale range to 1/8th the readable predetermined full-scale value and use a right-shift value of 3. With this implementation, the resolution of the measurement is increased by a factor of 8, and because the result is digitally divided by 8 by right shifting, the bit weight of the measurement still meets the standard's specification (i.e., SFF-8472).

The right-shift operation on the ADC result is carried out based on the contents of Right Shift Control registers (Table 02h, Registers 8Eh-8Fh) in EEPROM. Four analog channels, MON1–MON4, each have 3 bits allocated to set the number of right shifts. Up to 7 right-shift oper-

ations are allowed and are executed as a part of every conversion before the results are compared to the high and low alarm levels, or loaded into their corresponding measurement registers (Table 01h, Registers 62h–6Bh). This is true during the setup of internal calibration as well as during subsequent data conversions.

## Transmit Fault (TX-F) Output

The TX-F output has masking registers for the six ADC alarms and the four QT alarms to select which comparisons cause it to assert. In addition, the FETG alarm is selectable through the TX-F mask to cause TX-F to assert. All alarms, with the exception of FETG, only cause TX-F to remain active while the alarm condition persists. However, the TX-F latch bit can enable the TX-F output to remain active until it is cleared by the TX-F reset bit, TX-D, soft TX-D, or by power cycling the part. If the FETG output is configured to trigger TX-F, it indicates that the DS1865 is in shutdown, and requires TX-D, soft TX-D, or cycling power to reset. The QT alarms are masked until the completion of the binary search. Only enabled alarms will activate TX-F. See Figure 5.

Table 4 shows TX-F as a function of TX-D and the alarm sources.

## Safety Shutdown (FETG) Output

The FETG output has masking registers (separate from TX-F) for the five ADC alarms and the four QT alarms to select which comparisons cause it to assert. Unlike TX-F, the FETG output is always latched in case it is triggered by an unmasked alarm condition. Its output polarity is programmable to allow an external nMOSFET or pMOSFET to open during alarms to shut off the laser diode current. If the FETG output triggers, indicating that the DS1865 is in shutdown, it requires TX-D, soft TX-D, or cycling power to be reset. Under all conditions, when the analog outputs are reinitialized after being disabled, all the alarms with the exception of the  $V_{CC}$  low ADC alarm are cleared. The  $V_{CC}$  low alarm must remain active to prevent the output from attempting to operate when

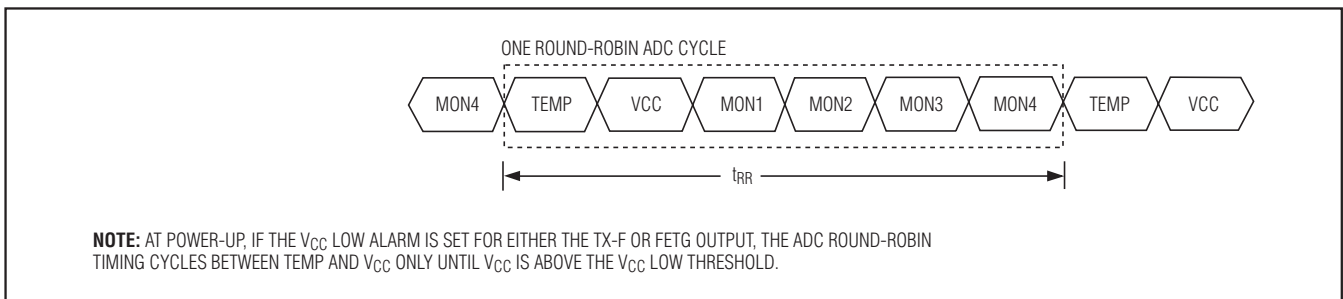

Figure 4. ADC Round-Robin Timing



# PON Triplexer Control and Monitoring Circuit

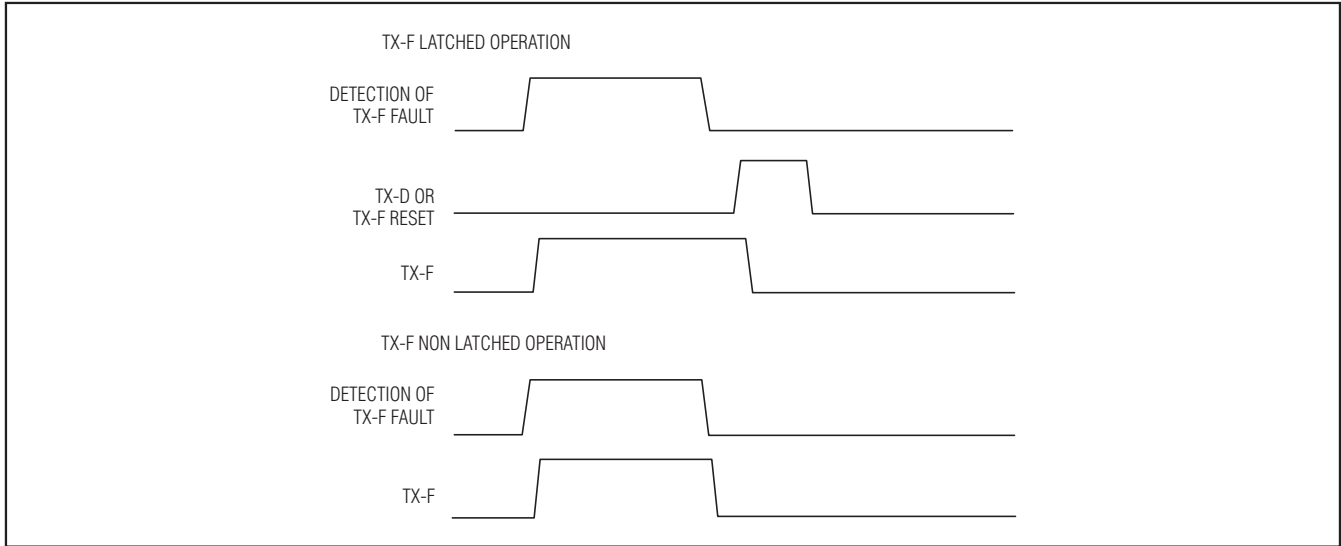

Figure 5. TX-F Timing

**Table 4. TX-F as a Function of TX-D and Alarm Sources**

V <sub>CC</sub> > V <sub>POA</sub>	TX-D	NONMASKED TX-F ALARM	TX-F
No	X	X	1
Yes	0	0	0
Yes	0	1	1
Yes	1	X	0

inadequate V<sub>CC</sub> exists to operate the laser driver. Once adequate V<sub>CC</sub> is present to clear the V<sub>CC</sub> low alarm, the outputs are enabled following the same sequence as the power-up sequence.

As previously mentioned, the FETG is an output used to disable the laser current through a series nMOSFET or pMOSFET. This requires that the FETG output can sink or source current. Because the DS1865 does not know if it should sink or source current before V<sub>CC</sub> exceeds V<sub>POA</sub>, which triggers the EE recall, this output will be high impedance when V<sub>CC</sub> is below V<sub>POA</sub> (see the *Low-Voltage Operation* section for details and diagram). The application circuit must use a pullup or pulldown resistor on this pin that pulls FETG to the alarm/shutdown state (high for a pMOS, low for a nMOS). Once V<sub>CC</sub> is above V<sub>POA</sub>, the DS1865 pulls the FETG output to the state determined by the FETG DIR bit (Table 02h, Register 89h). FETG DIR is 0 if an nMOS is used and 1 if a pMOS is used.

### Determining Alarm Causes Using the I<sup>2</sup>C Interface

To determine the cause of the TX-F or FETG alarm, the system processor can read the DS1865's Alarm Trap Bytes (ATB) through the I<sup>2</sup>C interface (in Table 01h). The ATB has a bit for each alarm. Any time an alarm occurs, regardless of the mask bit's state, the DS1865 sets the corresponding bit in the ATB. Active ATB bits remain set until written to zeros through the I<sup>2</sup>C interface. On power-up, the ATB is zeros until alarms dictate otherwise.

### Die Identification

The DS1865 has an ID hard coded to its die. Two registers (Table 02h bytes 86h–87h) are assigned for this feature. Byte 86h reads 65h to identify the part as the DS1865, byte 87h reads the die revision.

### Low-Voltage Operation

The DS1865 contains two power-on reset (POR) levels. The lower level is a digital POR (V<sub>POD</sub>) and the higher level is an analog POR (V<sub>POA</sub>). At startup, before the supply voltage rises above V<sub>POA</sub>, the outputs are disabled (FETG and BIAS outputs are high impedance, MOD is low), all SRAM locations are low (including shadowed EEPROM), and all analog circuitry is disabled. When V<sub>CC</sub> reaches V<sub>POA</sub>, the SEE is recalled, and the analog circuitry is enabled. While V<sub>CC</sub> remains above V<sub>POA</sub>, the device is in its normal operating state, and it responds based on its nonvolatile configuration. If during operation V<sub>CC</sub> falls below V<sub>POA</sub> but is still above V<sub>POD</sub>, the SRAM retains the SEE settings from

# PON Triplexer Control and Monitoring Circuit

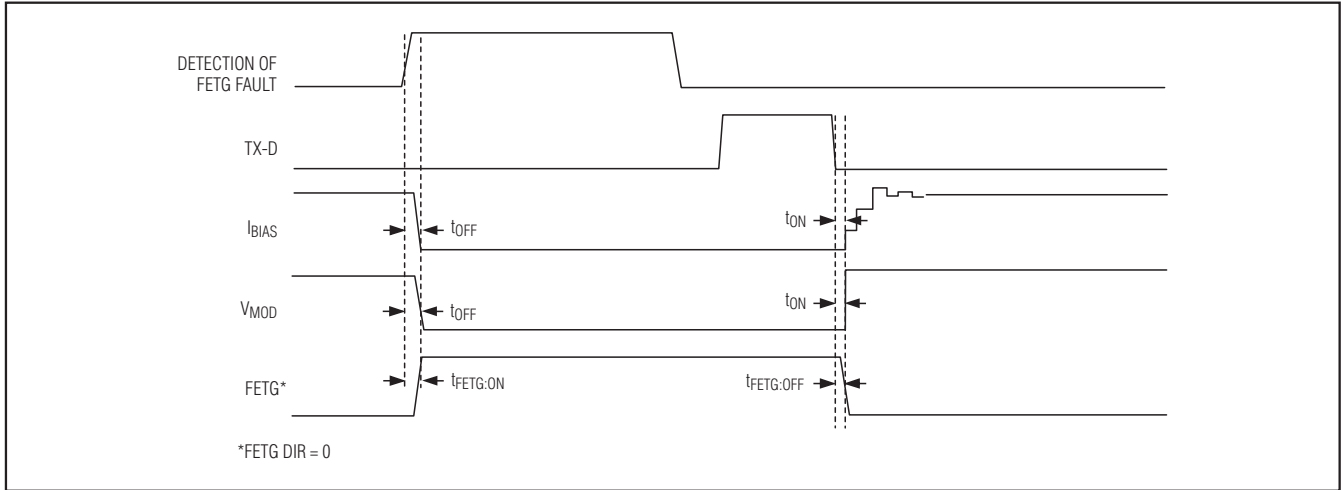

Figure 6. FETG/Modulation and Bias Timing (Fault Condition Detected)

**Table 5. FETG, MOD, and BIAS Outputs as a Function of TX-D and Alarm Sources**

VCC > VPOA	TX-D	NONMASKED FETG ALARM	FETG	MOD AND BIAS OUTPUTS
Yes	0	0	FETG DIR	Enabled
Yes	0	1	<u>FETG DIR</u>	Disabled
Yes	1	X	FETG DIR	Disabled

the first SEE recall, but the device analog is shut down and the outputs are disabled. FETG is driven to its alarm state defined by the FETG DIR bit (Table 02h, Register 89h). If the supply voltage recovers back above VPOA, the device immediately resumes normal functioning. If the supply voltage falls below VPOD, the device SRAM is placed in its default state and another SEE recall is required to reload the nonvolatile settings. The EEPROM recall occurs the next time VCC exceeds VPOA. Figure 7 shows the sequence of events as the voltage varies.

Any time VCC is above VPOD, the I2C interface can be used to determine if VCC is below the VPOA level. This is accomplished by checking the RDYB bit in the status (Lower Memory, Register 6Eh) byte. RDYB is set when VCC is below VPOA. When VCC rises above VPOA, RDYB is timed (within 500µs) to go to 0, at which point the part is fully functional.

For all device addresses sourced from EEPROM (Table 02h, Register 8Ch), the default device address is A2h until VCC exceeds VPOA allowing the device address to be recalled from the EEPROM.

### Power-On Analog (POA)

POA holds the DS1865 in reset until VCC is at a suitable level (VCC > VPOA) for the part to accurately measure with its ADC and compare analog signals with its quick-trip monitors. Because VCC cannot be measured by the ADC when VCC is less than VPOA, POA also asserts the VCC low alarm, which is cleared by a VCC ADC conversion greater than the customer-programmable VCC low ADC limit. This prevents the TX-F and FETG outputs from glitching during a slow power-up. The TX-F and FETG outputs do not latch until there is a conversion above VCC low limit.

The POA alarm is nonmaskable. The TX-F and FETG outputs are asserted when VCC is below VPOA. See the *Low-Voltage Operation* section for more information.

### DAC1 Output

The DAC1 output has a 0 to 2.5V range, 8 bits of resolution, and is programmed through the I2C interface. The DAC1 setting is nonvolatile and password 2 (PW2) protected.

### M4DAC Output

The M4DAC output has a 0 to 2.5V range, 8 bits of resolution, and is controlled by an LUT indexed by the MON4 voltage. The M4DAC LUT (Table 06h) is nonvolatile and PW2 protected. See the *Memory Organization* section for details.



# PON Triplexer Control and Monitoring Circuit

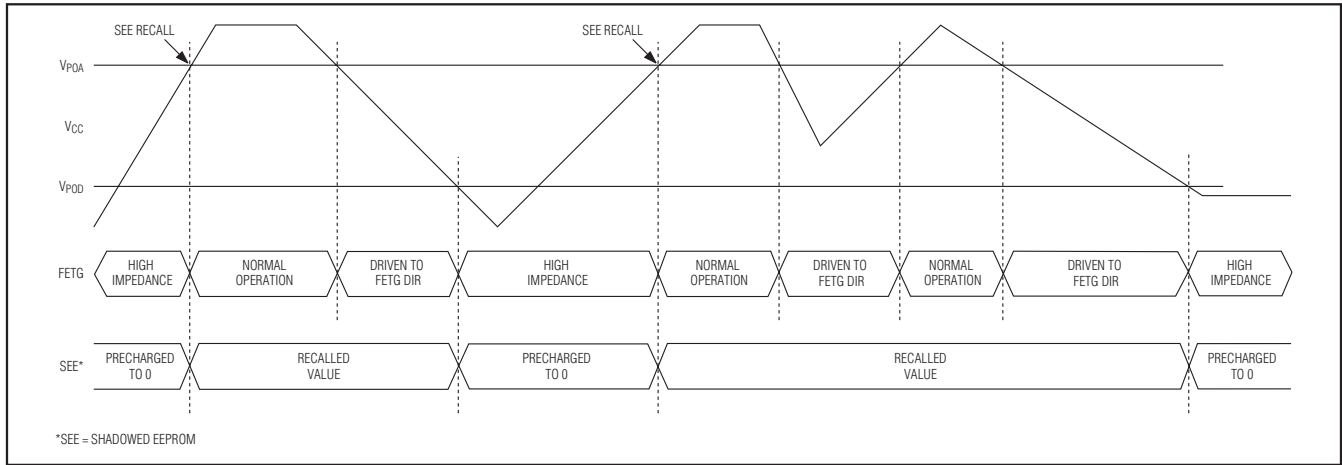

Figure 7. Low-Voltage Hysteresis Example

## Digital I/O Pins

Five digital I/O pins are provided for additional monitoring and control of the triplexer. By default the LOSI pin is used to convert a standard comparator output for loss of signal (LOSI) to an open-collector output. This means the mux shown on the block diagram by default selects the LOSI pin as the source for the D0 output transistor. The level of the D0 pin can be read in the status byte (Lower Memory, Register 6Eh) as the LOS status bit. The LOS status bit reports back the logic level of the D0 pin, so an external pullup resistor must be provided for this pin to output a high level. The LOSI signal can be inverted before driving the open-drain output transistor using the XOR gate provided. The mux LOSI allows the D0 pin to be used identically to the D1, D2, and D3 pins. However, the mux setting (stored in the EEPROM) does not take effect until  $V_{CC} > V_{POA}$ , allowing the EEPROM to recall. This requires the LOSI pin to be grounded for D0 to act identically to the D1, D2, and D3 pins.

Digital pins D1, D2, and D3 can be used as inputs or outputs. External pullup resistors must be provided to realize high logic levels. The levels of these input pins can be read by reading the DIN byte (Lower Memory, Register 79h), and the open-drain outputs can be controlled using the DOUT byte (Lower Memory, Register 78h). When  $V_{CC} < V_{POA}$ , these outputs are high impedance. Once  $V_{CC} \geq V_{POA}$ , the outputs go to the power-on default state stored in the DPU byte (Table 02h, Register C0h). The EEPROM determined default state of the pin can be modified with PW2 access. After the default state has been recalled, the SRAM registers controlling outputs can be modified without password access. This

allows the outputs to be used to control serial interfaces without wearing out the default EEPROM setting.

## Memory Organization

The DS1865 features eight banks of memory composed of the following.

The **Lower Memory** is addressed from 00h to 7Fh and contains alarm and warning thresholds, flags, masks, several control registers, password entry area (PWE), and the table select byte. The table select byte determines which table (01h–06h) will be mapped into the upper memory locations, namely 80h–FFh (unless stated otherwise).

**Table 01h** primarily contains user EEPROM (with PW1 level access) as well as some alarm and warning status bytes.

**Table 02h** is a multifunction space that contains configuration registers, scaling and offset values, passwords, interrupt registers, as well as other miscellaneous control bytes.

**Table 03h** is strictly user EEPROM that is protected by a PW2 level access.

**Table 04h** contains a temperature-indexed LUT for control of the modulation voltage. The modulation LUT can be programmed in 2°C increments over the -40°C to +102°C range. This register is protected by a PW2 level access.

**Table 05h** contains another LUT, which allows the APC set point to change as a function of temperature to compensate for tracking error (TE). This TE LUT has 36 entries that determine the APC setting in 4°C windows between -40°C to +100°C. This register is protected by a PW2 level access.

# PON Triplexer Control and Monitoring Circuit

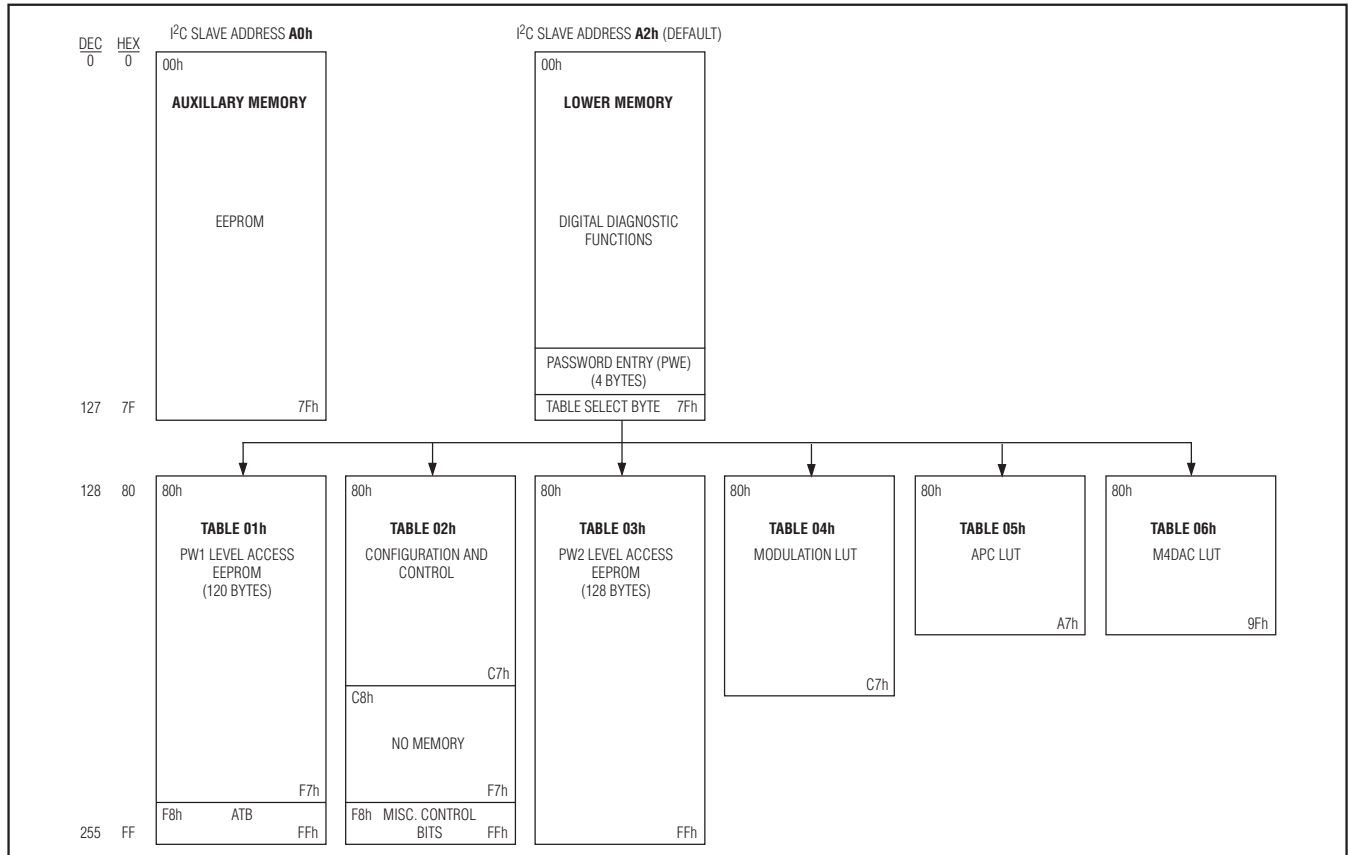

Figure 8. Memory Map

**Table 06h** contains a MON4-indexed LUT for control of the M4DAC voltage. The M4DAC LUT has 32 entries that are configurable to act as one 32-entry LUT or two 16-entry LUTs. When configured as one 32-byte LUT, each entry corresponds to an increment of 1/32 of the full scale. When configured as two 16-byte LUTs, the first 16 bytes and the last 16 bytes each correspond to 1/16 of full scale. Either of the two sections is selected with a separate configuration bit. This LUT is protected by a PW2 level access.

**Auxiliary Memory** is EEPROM accessible at the I2C slave address, A0h.

See the register map tables for a more complete detail of each byte's function, as well as for read/write permissions for each byte.

### Shadowed EEPROM

In addition to volatile memory (SRAM) and nonvolatile memory (EEPROM), the DS1865 also features shadowed

EEPROM. Shadowed EEPROM (SEE) can be configured as either volatile or nonvolatile memory using the SEEB bit in Table 02h, Register 80h.

The DS1865 uses shadowed EEPROM memory for key memory addresses that can be rewritten many times. By default the shadowed EEPROM bit, SEEB, is not set and these locations act as ordinary EEPROM. By setting SEEB, these locations function like SRAM cells, which allow an infinite number of write cycles without concern of wearing out the EEPROM. This also eliminates the requirement for the EEPROM write time,  $t_{WR}$ . Because changes made with SEEB enabled do not affect the EEPROM, these changes are not retained through power cycles. The power-up value is the last value written with SEEB disabled. This function can be used to limit the number of EEPROM writes during calibration or to change the monitor thresholds periodically during normal operation, helping to reduce the number of times EEPROM is written. The *Memory Organization* description indicates which locations are shadowed EEPROM.

# PON Triplexer Control and Monitoring Circuit

## I<sup>2</sup>C Definitions

The following terminology is commonly used to describe I<sup>2</sup>C data transfers.

**Master Device:** The master device controls the slave devices on the bus. The master device generates SCL clock pulses and START and STOP conditions.

**Slave Devices:** Slave devices send and receive data at the master's request.

**Bus Idle or Not Busy:** Time between STOP and START conditions when both SDA and SCL are inactive and in their logic-high states. When the bus is idle, it often initiates a low-power mode for slave devices.

**START Condition:** A START condition is generated by the master to initiate a new data transfer with a slave. Transitioning SDA from high to low while SCL remains high generates a START condition. See Figure 9 for applicable timing.

**STOP Condition:** A STOP condition is generated by the master to end a data transfer with a slave. Transitioning SDA from low to high while SCL remains high generates a STOP condition. See Figure 9 for applicable timing.

**Repeated START Condition:** The master can use a repeated START condition at the end of one data transfer to indicate that it will immediately initiate a new data transfer following the current one. Repeated START conditions are commonly used during read operations to identify a specific memory address to begin a data transfer. A repeated START condition is issued identically to a normal START condition. See Figure 9 for applicable timing.

**Bit Write:** Transitions of SDA must occur during the low state of SCL. The data on SDA must remain valid and unchanged during the entire high pulse of SCL plus the setup and hold-time requirements (Figure 9). Data is shifted into the device during the rising edge of the SCL.

**Bit Read:** At the end of a write operation, the master must release the SDA bus line for the proper amount of setup time before the next rising edge of SCL during a bit read. The device shifts out each bit of data on SDA at the falling edge of the previous SCL pulse and the data bit is valid at the rising edge of the current SCL pulse. Remember that the master generates all SCL clock pulses including when it is reading bits from the slave.

**Acknowledgement (ACK and NACK):** An acknowledgement (ACK) or not acknowledge (NACK) is always the 9th bit transmitted during a byte transfer. The device receiving data (the master during a read or the slave

during a write operation) performs an ACK by transmitting a zero during the 9th bit. A device performs a NACK by transmitting a one during the 9th bit. Timing for the ACK and NACK is identical to all other bit writes. An ACK is the acknowledgment that the device is properly receiving data. A NACK is used to terminate a read sequence or as an indication that the device is not receiving data.

**Byte Write:** A byte write consists of 8 bits of information transferred from the master to the slave (most significant bit first) plus a 1-bit acknowledgement from the slave to the master. The 8 bits transmitted by the master are done according to the bit write definition and the acknowledgement is read using the bit read definition.

**Byte Read:** A byte read is an 8-bit information transfer from the slave to the master plus a 1-bit ACK or NACK from the master to the slave. The 8 bits of information that are transferred (most significant bit first) from the slave to the master are read by the master using the bit read definition, and the master transmits an ACK using the bit write definition to receive additional data bytes. The master must NACK the last byte read to terminate communication so the slave returns control of SDA to the master.

**Slave Address Byte:** Each slave on the I<sup>2</sup>C bus responds to a slave addressing byte (Figure 9) sent immediately following a START condition. The slave address byte contains the slave address in the most significant 7 bits and the R/W bit in the least significant bit.

The DS1865 responds to two slave addresses. The auxiliary memory always responds to a fixed I<sup>2</sup>C slave address, A0h. The Lower Memory and tables 01h–06h respond to I<sup>2</sup>C slave addresses that can be configured to any value between 00h–FEh using the Device Address byte (Table 02h, Register 8Ch). The user also must set the ASEL bit (Table 02h, Register 89h) for this address to be active. By writing the correct slave address with  $R/\bar{W} = 0$ , the master indicates it will write data to the slave. If  $R/\bar{W} = 1$ , the master reads data from the slave. If an incorrect slave address is written, the DS1865 assumes the master is communicating with another I<sup>2</sup>C device and ignores the communications until the next START condition is sent.

**Memory Address:** During an I<sup>2</sup>C write operation, the master must transmit a memory address to identify the memory location where the slave is to store the data. The memory address is always the second byte transmitted during a write operation following the slave address byte.

# PON Triplexer Control and Monitoring Circuit

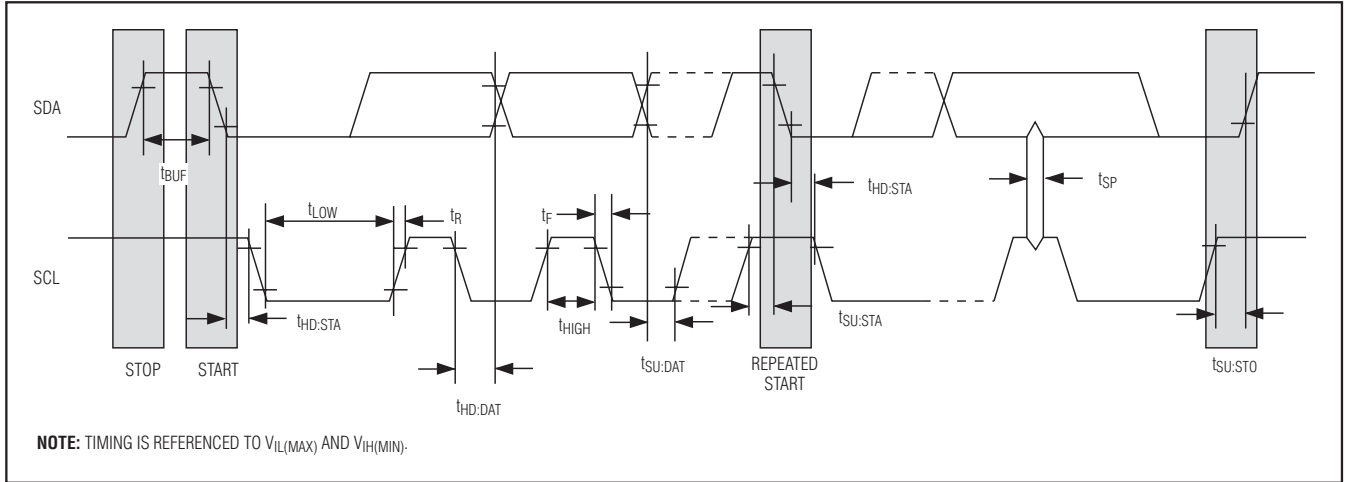

Figure 9. I<sup>2</sup>C Timing Diagram

## I<sup>2</sup>C Communication

**Writing a Single Byte to a Slave:** The master must generate a START condition, write the I<sup>2</sup>C slave address byte ( $R/\overline{W} = 0$ ), write the byte of data, and generate a STOP condition. The master must read the slave's acknowledgement during all byte write operations.

**Writing Multiple Bytes to a Slave:** To write multiple bytes to a slave, the master generates a START condition, writes the slave address byte ( $R/\overline{W} = 0$ ), writes the memory address, writes up to 8 data bytes, and generates a STOP condition. The DS1865 writes 1 to 8 bytes (1 page or row) with a single write transaction. This is internally controlled by an address counter that allows data to be written to consecutive addresses without transmitting a memory address before each data byte is sent. The address counter limits the write to one 8-byte page (one row of the memory map). Attempts to write to additional pages of memory without sending a STOP condition between pages result in the address counter wrapping around to the beginning of the present row.

**Example:** A 3-byte write starts at address 06h and writes three data bytes (11h, 22h, and 33h) to three "consecutive" addresses. The result is that addresses 06h and 07h contain 11h and 22h, respectively, and the third data byte, 33h, is written to address 00h.

To prevent address wrapping from occurring, the master must send a STOP condition at the end of the page, then wait for the bus-free or EEPROM-write time to elapse. Then the master can generate a new START

condition, and write the slave address byte ( $R/\overline{W} = 0$ ) and the first memory address of the next memory row before continuing to write data.

**Acknowledge Polling:** Any time an EEPROM location is written, the DS1865 requires the EEPROM write time ( $t_w$ ) after the STOP condition to write the contents of the byte of data to EEPROM. During the EEPROM write time, the device does not acknowledge its slave address because it is busy. It is possible to take advantage of that phenomenon by repeatedly addressing the DS1865, which allows the next page to be written as soon as the DS1865 is ready to receive the data. The alternative to acknowledge polling is to wait for a maximum period of  $t_w$  to elapse before attempting to write again to the DS1865.

**EEPROM Write Cycles:** When EEPROM writes occur to the memory, the DS1865 writes to all three EEPROM memory locations, even if only a single byte was modified. Because all three bytes are written, the bytes that were not modified during the write transaction are still subject to a write cycle. This can result in all three bytes being worn out over time by writing a single byte repeatedly. The DS1865's EEPROM write cycles are specified in the *Nonvolatile Memory Characteristics* table. The specification shown is at the worst-case temperature. It can handle approximately 10 times that many writes at room temperature. Writing to SRAM-shadowed EEPROM memory with SEEB = 1 does not count as an EEPROM write cycle when evaluating the EEPROM's estimated lifetime.

# PON Triplexer Control and Monitoring Circuit

**Reading a Single Byte from a Slave:** Unlike the write operation that uses the memory address byte to define where the data is to be written, the read operation occurs at the present value of the memory address counter. To read a single byte from the slave, the master generates a START condition, writes the slave address byte with  $R/\overline{W} = 1$ , reads the data byte with a NACK to indicate the end of the transfer, and generates a STOP condition.

**Manipulating the Address Counter for Reads:** A dummy write cycle can be used to force the address pointer to a particular value. To do this, the master generates a START condition, writes the slave address byte ( $R/\overline{W} = 0$ ), writes the memory address where it desires to read, generates a repeated START condition, writes the slave address byte ( $R/\overline{W} = 1$ ), reads data with ACK or NACK as applicable, and generates a STOP condition.

# PON Triplexer Control and Monitoring Circuit

## Register Maps

### Lower Memory Register Map

This register map shows each byte/word in terms of the row it is on in the memory. The first byte in the row is located in memory at the hexadecimal row address in the left-most column. Each subsequent byte on the row is one/two memory locations beyond the previous

byte/word's address. A total of 8 bytes are present on each row. For more information about each of these bytes, see the corresponding register description in the following tables.

LOWER MEMORY									
ROW (HEX)	ROW NAME	WORD 0		WORD 1		WORD 2		WORD 3	
		BYTE 0/8	BYTE 1/9	BYTE 2/A	BYTE 3/B	BYTE 4/C	BYTE 5/D	BYTE 6/E	BYTE 7/F
00	<1>THRESHOLD <sub>0</sub>	TEMP ALARM HI		TEMP ALARM LO		TEMP WARN HI		TEMP WARN LO	
08	<1>THRESHOLD <sub>1</sub>	VCC ALARM HI		VCC ALARM LO		VCC WARN HI		VCC WARN LO	
10	<1>THRESHOLD <sub>2</sub>	MON1 ALARM HI		MON1 ALARM LO		MON1 WARN HI		MON1 WARN LO	
18	<1>THRESHOLD <sub>3</sub>	MON2 ALARM HI		MON2 ALARM LO		MON2 WARN HI		MON2 WARN LO	
20	<1>THRESHOLD <sub>4</sub>	MON3 ALARM HI		MON3 ALARM LO		MON3 WARN HI		MON3 WARN LO	
28	<1>THRESHOLD <sub>5</sub>	MON4 ALARM HI		MON4 ALARM LO		MON4 WARN HI		MON4 WARN LO	
30	<1>PW2 EE	EE	EE	EE	EE	EE	EE	EE	EE
38	<1>PW2 EE	EE	EE	EE	EE	EE	EE	EE	EE
40	<1>PW2 EE	EE	EE	EE	EE	EE	EE	EE	EE
48	<1>PW2 EE	EE	EE	EE	EE	EE	EE	EE	EE
50	<1>PW2 EE	EE	EE	EE	EE	EE	EE	EE	EE
58	<1>PW2 EE	EE	EE	EE	EE	EE	EE	EE	EE
60	<2>ADC VALUES <sub>0</sub>	TEMP VALUE		VCC VALUE		MON1 VALUE		MON2 VALUE	
68	<0> ADC VALUES <sub>1</sub>	<2>MON3 VALUE		<2> MON4 VALUE		<2>RESERVED		<0>STATUS	<3>UPDATE
70	<2>ALARM/WARN	ALARM <sub>3</sub>	ALARM <sub>2</sub>	ALARM <sub>1</sub>	ALARM <sub>0</sub>	WARN <sub>3</sub>	WARN <sub>2</sub>	RESERVED	
78	<0>TABLE SELECT	<2>DOUT	<2>DIN	<6>RESERVED	<6>PWE MSB		<6>PWE LSB		<5>TBL SEL

ACCESS CODE	<0>	<1>	<2>	<3>	<4>	<5>	<6>	<7>	<8>	<9>	<10>	<11>
Read Access	See each bit/byte separately	All	All	All	PW2	All	N/A	PW1	PW2	N/A	PW2	All
Write Access		PW2	N/A	All and DS1865 hardware	PW2 + mode bit	All	All	PW1	PW2	PW2	N/A	PW1

# PON Triplexer Control and Monitoring Circuit

DS1865

**Table 01h Register Map**

TABLE 01h (PW1)									
ROW (HEX)	ROW NAME	WORD 0		WORD 1		WORD 2		WORD 3	
		BYTE 0/8	BYTE 1/9	BYTE 2/A	BYTE 3/B	BYTE 4/C	BYTE 5/D	BYTE 6/E	BYTE 7/F
80	<7>PW1 EE	EE	EE	EE	EE	EE	EE	EE	EE
88	<7>PW1 EE	EE	EE	EE	EE	EE	EE	EE	EE
90	<7>PW1 EE	EE	EE	EE	EE	EE	EE	EE	EE
98	<7>PW1 EE	EE	EE	EE	EE	EE	EE	EE	EE
A0	<7>PW1 EE	EE	EE	EE	EE	EE	EE	EE	EE
A8	<7>PW1 EE	EE	EE	EE	EE	EE	EE	EE	EE
B0	<7>PW1 EE	EE	EE	EE	EE	EE	EE	EE	EE
B8	<7>PW1 EE	EE	EE	EE	EE	EE	EE	EE	EE
C0	<7>PW1 EE	EE	EE	EE	EE	EE	EE	EE	EE
C8	<7>PW1 EE	EE	EE	EE	EE	EE	EE	EE	EE
D0	<7>PW1 EE	EE	EE	EE	EE	EE	EE	EE	EE
D8	<7>PW1 EE	EE	EE	EE	EE	EE	EE	EE	EE
E0	<7>PW1 EE	EE	EE	EE	EE	EE	EE	EE	EE
E8	<7>PW1 EE	EE	EE	EE	EE	EE	EE	EE	EE
F0	<7>PW1 EE	EE	EE	EE	EE	EE	EE	EE	EE
F8	<11>ALARM TRAP	ALARM <sub>3</sub>	ALARM <sub>2</sub>	ALARM <sub>1</sub>	ALARM <sub>0</sub>	WARN <sub>3</sub>	WARN <sub>2</sub>	RESERVED	

ACCESS CODE	<0>	<1>	<2>	<3>	<4>	<5>	<6>	<7>	<8>	<9>	<10>	<11>
Read Access	See each bit/byte separately	All	All	All	PW2	All	N/A	PW1	PW2	N/A	PW2	All
Write Access		PW2	N/A	All and DS1865 hardware	PW2 + mode bit	All	All	PW1	PW2	PW2	N/A	PW1

# PON Triplexer Control and Monitoring Circuit

## Table 02h Register Map

TABLE 02h (PW2)									
ROW (HEX)	ROW NAME	WORD 0		WORD 1		WORD 2		WORD 3	
		BYTE 0/8	BYTE 1/9	BYTE 2/A	BYTE 3/B	BYTE 4/C	BYTE 5/D	BYTE 6/E	BYTE 7/F
80	<0> CONFIG <sub>0</sub>	<8> MODE	<4> T INDEX	<4> MOD DAC	<4> APC DAC	<4> V INDEX	<4> M4DAC	<10> DEVICE ID	<10> DEVICEVER
88	<8> CONFIG <sub>1</sub>	UPDATE RATE	CONFIG	STARTUP STEP	MOD RANGING	DEVICE ADDRESS	COMP RANGING	RSHIFT <sub>1</sub>	RSHIFT <sub>0</sub>
90	<8> SCALE <sub>0</sub>	RESERVED		V <sub>CC</sub> SCALE		MON1 SCALE		MON2 SCALE	
98	<8> SCALE <sub>1</sub>	MON3 SCALE		MON4 SCALE		RESERVED		RESERVED	
A0	<8> OFFSET <sub>0</sub>	RESERVED		V <sub>CC</sub> OFFSET		MON1 OFFSET		MON2 OFFSET	
A8	<8> OFFSET <sub>1</sub>	MON3 OFFSET		MON4 OFFSET		RESERVED		INTERNAL TEMP OFFSET*	
B0	<8> PWD VALUE	PW1 MSW		PW1 LSW		PW2 MSW		PW2 LSW	
B8	<8> INTERRUPT	FETG EN <sub>1</sub>	FETG EN <sub>0</sub>	TX-F EN <sub>1</sub>	TX-F EN <sub>0</sub>	HTXP	LTXP	HBIAS	MAX IBIAS
C0	<8> CNTL OUT	DPU	RESERVED	RESERVED	RESERVED	DAC1	RESERVED	RESERVED	M4 LUT CNTL
C8-F7	EMPTY	EMPTY	EMPTY	EMPTY	EMPTY	EMPTY	EMPTY	EMPTY	EMPTY
F8	<0> MAN IBIAS	<4> MAN IBIAS <sub>1</sub>	<4> MAN IBIAS <sub>0</sub>	<4> MAN_CNTL	<10> BIAS DAC <sub>1</sub>	<10> BIAS DAC <sub>0</sub>	RESERVED	RESERVED	RESERVED

\*The final result must be XORed with BB40h before writing to this register.

ACCESS CODE	<0>	<1>	<2>	<3>	<4>	<5>	<6>	<7>	<8>	<9>	<10>	<11>
Read Access	See each bit/byte separately	All	All	All	PW2	All	N/A	PW1	PW2	N/A	PW2	All
Write Access		PW2	N/A	All and DS1865 hardware	PW2 + mode bit	All	All	PW1	PW2	PW2	N/A	PW1



# PON Triplexer Control and Monitoring Circuit

DS1865

**Table 03h Register Map**

TABLE 03h (PW3)									
ROW (HEX)	ROW NAME	WORD 0		WORD 1		WORD 2		WORD 3	
		BYTE 0/8	BYTE 1/9	BYTE 2/A	BYTE 3/B	BYTE 4/C	BYTE 5/D	BYTE 6/E	BYTE 7/F
80	<8>PW2 EE	EE	EE	EE	EE	EE	EE	EE	EE
88	<8>PW2 EE	EE	EE	EE	EE	EE	EE	EE	EE
90	<8>PW2 EE	EE	EE	EE	EE	EE	EE	EE	EE
98	<8>PW2 EE	EE	EE	EE	EE	EE	EE	EE	EE
A0	<8>PW2 EE	EE	EE	EE	EE	EE	EE	EE	EE
A8	<8>PW2 EE	EE	EE	EE	EE	EE	EE	EE	EE
B0	<8>PW2 EE	EE	EE	EE	EE	EE	EE	EE	EE
B8	<8>PW2 EE	EE	EE	EE	EE	EE	EE	EE	EE
C0	<8>PW2 EE	EE	EE	EE	EE	EE	EE	EE	EE
C8	<8>PW2 EE	EE	EE	EE	EE	EE	EE	EE	EE
D0	<8>PW2 EE	EE	EE	EE	EE	EE	EE	EE	EE
D8	<8>PW2 EE	EE	EE	EE	EE	EE	EE	EE	EE
E0	<8>PW2 EE	EE	EE	EE	EE	EE	EE	EE	EE
E8	<8>PW2 EE	EE	EE	EE	EE	EE	EE	EE	EE
F0	<8>PW2 EE	EE	EE	EE	EE	EE	EE	EE	EE
F8	<8>PW2 EE	EE	EE	EE	EE	EE	EE	EE	EE

ACCESS CODE	<0>	<1>	<2>	<3>	<4>	<5>	<6>	<7>	<8>	<9>	<10>	<11>
Read Access	See each bit/byte separately	All	All	All	PW2	All	N/A	PW1	PW2	N/A	PW2	All
Write Access		PW2	N/A	All and DS1865 hardware	PW2 + mode bit	All	All	PW1	PW2	PW2	N/A	PW1

# PON Triplexer Control and Monitoring Circuit

**Table 04h Register Map**

TABLE 04h (MOD LUT)									
ROW (HEX)	ROW NAME	WORD 0		WORD 1		WORD 2		WORD 3	
		BYTE 0/8	BYTE 1/9	BYTE 2/A	BYTE 3/B	BYTE 4/C	BYTE 5/D	BYTE 6/E	BYTE 7/F
80	<8>LUT4	MOD	MOD	MOD	MOD	MOD	MOD	MOD	MOD
88	<8>LUT4	MOD	MOD	MOD	MOD	MOD	MOD	MOD	MOD
90	<8>LUT4	MOD	MOD	MOD	MOD	MOD	MOD	MOD	MOD
98	<8>LUT4	MOD	MOD	MOD	MOD	MOD	MOD	MOD	MOD
A0	<8>LUT4	MOD	MOD	MOD	MOD	MOD	MOD	MOD	MOD
A8	<8>LUT4	MOD	MOD	MOD	MOD	MOD	MOD	MOD	MOD
B0	<8>LUT4	MOD	MOD	MOD	MOD	MOD	MOD	MOD	MOD
B8	<8>LUT4	MOD	MOD	MOD	MOD	MOD	MOD	MOD	MOD
C0	<8>LUT4	MOD	MOD	MOD	MOD	MOD	MOD	MOD	MOD

ACCESS CODE	<0>	<1>	<2>	<3>	<4>	<5>	<6>	<7>	<8>	<9>	<10>	<11>
Read Access	See each bit/byte separately	All	All	All	PW2	All	N/A	PW1	PW2	N/A	PW2	All
Write Access		PW2	N/A	All and DS1865 hardware	PW2 + mode bit	All	All	PW1	PW2	PW2	N/A	PW1

**Table 05h Register Map**

TABLE 05h (APC LUT)									
ROW (HEX)	ROW NAME	WORD 0		WORD 1		WORD 2		WORD 3	
		BYTE 0/8	BYTE 1/9	BYTE 2/A	BYTE 3/B	BYTE 4/C	BYTE 5/D	BYTE 6/E	BYTE 7/F
80	<8>LUT5	APC REF	APC REF	APC REF	APC REF	APC REF	APC REF	APC REF	APC REF
88	<8>LUT5	APC REF	APC REF	APC REF	APC REF	APC REF	APC REF	APC REF	APC REF
90	<8>LUT5	APC REF	APC REF	APC REF	APC REF	APC REF	APC REF	APC REF	APC REF
98	<8>LUT5	APC REF	APC REF	APC REF	APC REF	APC REF	APC REF	APC REF	APC REF
A0	<8>LUT5	APC REF	APC REF	APC REF	APC REF	RESERVED	RESERVED	RESERVED	RESERVED

ACCESS CODE	<0>	<1>	<2>	<3>	<4>	<5>	<6>	<7>	<8>	<9>	<10>	<11>
Read Access	See each bit/byte separately	All	All	All	PW2	All	N/A	PW1	PW2	N/A	PW2	All
Write Access		PW2	N/A	All and DS1865 hardware	PW2 + mode bit	All	All	PW1	PW2	PW2	N/A	PW1

# PON Triplexer Control and Monitoring Circuit

**DS1865**

**Table 06h Register Map**

TABLE 06h (LUT FOR M4DAC)									
ROW (HEX)	ROW NAME	WORD 0		WORD 1		WORD 2		WORD 3	
		BYTE 0/8	BYTE 1/9	BYTE 2/A	BYTE 3/B	BYTE 4/C	BYTE 5/D	BYTE 6/E	BYTE 7/F
80	<8>LUT6	M4DAC	M4DAC	M4DAC	M4DAC	M4DAC	M4DAC	M4DAC	M4DAC
88	<8>LUT6	M4DAC	M4DAC	M4DAC	M4DAC	M4DAC	M4DAC	M4DAC	M4DAC
90	<8>LUT6	M4DAC	M4DAC	M4DAC	M4DAC	M4DAC	M4DAC	M4DAC	M4DAC
98	<8>LUT6	M4DAC	M4DAC	M4DAC	M4DAC	M4DAC	M4DAC	M4DAC	M4DAC

ACCESS CODE	<0>	<1>	<2>	<3>	<4>	<5>	<6>	<7>	<8>	<9>	<10>	<11>
Read Access	See each bit/byte separately	All	All	All	PW2	All	N/A	PW1	PW2	N/A	PW2	All
Write Access		PW2	N/A	All and DS1865 hardware	PW2 + mode bit	All	All	PW1	PW2	PW2	N/A	PW1

# PON Triplexer Control and Monitoring Circuit

## AUX A0h Memory Register Map

AUX MEMORY (A0h)									
ROW (HEX)	ROW NAME	WORD 0		WORD 1		WORD 2		WORD 3	
		BYTE 0/8	BYTE 1/9	BYTE 2/A	BYTE 3/B	BYTE 4/C	BYTE 5/D	BYTE 6/E	BYTE 7/F
00	<5>AUX EE	EE	EE	EE	EE	EE	EE	EE	EE
08	<5>AUX EE	EE	EE	EE	EE	EE	EE	EE	EE
10	<5>AUX EE	EE	EE	EE	EE	EE	EE	EE	EE
18	<5>AUX EE	EE	EE	EE	EE	EE	EE	EE	EE
20	<5>AUX EE	EE	EE	EE	EE	EE	EE	EE	EE
28	<5>AUX EE	EE	EE	EE	EE	EE	EE	EE	EE
30	<5>AUX EE	EE	EE	EE	EE	EE	EE	EE	EE
38	<5>AUX EE	EE	EE	EE	EE	EE	EE	EE	EE
40	<5>AUX EE	EE	EE	EE	EE	EE	EE	EE	EE
48	<5>AUX EE	EE	EE	EE	EE	EE	EE	EE	EE
50	<5>AUX EE	EE	EE	EE	EE	EE	EE	EE	EE
58	<5>AUX EE	EE	EE	EE	EE	EE	EE	EE	EE
60	<5>AUX EE	EE	EE	EE	EE	EE	EE	EE	EE
68	<5>AUX EE	EE	EE	EE	EE	EE	EE	EE	EE
70	<5>AUX EE	EE	EE	EE	EE	EE	EE	EE	EE
78	<5>AUX EE	EE	EE	EE	EE	EE	EE	EE	EE

ACCESS CODE	<0>	<1>	<2>	<3>	<4>	<5>	<6>	<7>	<8>	<9>	<10>	<11>
Read Access	See each bit/byte separately	All	All	All	PW2	All	N/A	PW1	PW2	N/A	PW2	All
Write Access		PW2	N/A	All and DS1865 hardware	PW2 + mode bit	All	All	PW1	PW2	PW2	N/A	PW1

# PON Triplexer Control and Monitoring Circuit

## Lower Memory Registers

### Lower Memory, Register 00h to 01h: Temp Alarm Hi

### Lower Memory, Register 04h to 05h: Temp Warn Hi

FACTORY DEFAULT: 7FFFh

READ ACCESS All

WRITE ACCESS PW2

MEMORY TYPE: Nonvolatile (SEE)

00h, 04h	S	$2^6$	$2^5$	$2^4$	$2^3$	$2^2$	$2^1$	$2^0$
01h, 05h	$2^{-1}$	$2^{-2}$	$2^{-3}$	$2^{-4}$	$2^{-5}$	$2^{-6}$	$2^{-7}$	$2^{-8}$
	bit7							bit0

Temperature measurement updates above this two's complement threshold will set its corresponding alarm or warning bit.

Temperature measurement updates equal to or below this threshold will clear its alarm or warning bit.

### Lower Memory, Register 02h to 03h: Temp Alarm Lo

### Lower Memory, Register 06h to 07h: Temp Warn Lo

FACTORY DEFAULT: 8000h

READ ACCESS All

WRITE ACCESS PW2

MEMORY TYPE: Nonvolatile (SEE)

02h, 06h	S	$2^6$	$2^5$	$2^4$	$2^3$	$2^2$	$2^1$	$2^0$
03h, 07h	$2^{-1}$	$2^{-2}$	$2^{-3}$	$2^{-4}$	$2^{-5}$	$2^{-6}$	$2^{-7}$	$2^{-8}$
	bit7							bit0

Temperature measurement updates above this two's complement threshold will set its corresponding alarm or warning bit.

Temperature measurement updates equal to or below this threshold will clear its alarm or warning bit.

# PON Triplexer Control and Monitoring Circuit

- Lower Memory, Register 08h to 09h: V<sub>CC</sub> Alarm Hi
- Lower Memory, Register 0Ch to 0dh: V<sub>CC</sub> Warn Hi
- Lower Memory, Register 10h to 11h: MON1 Alarm Hi
- Lower Memory, Register 14h to 15h: MON1 Warn Hi
- Lower Memory, Register 18h to 19h: MON2 Alarm Hi
- Lower Memory, Register 1Ch to 1Dh: MON2 Warn Hi
- Lower Memory, Register 20h to 21h: MON3 Alarm Hi
- Lower Memory, Register 24h to 25h: MON3 Warn Hi
- Lower Memory, Register 28h to 29h: MON4 Alarm Hi
- Lower Memory, Register 2Ch to 2Dh: MON4 Warn Hi

FACTORY DEFAULT:            FFFFh  
 READ ACCESS                All  
 WRITE ACCESS              PW2  
 MEMORY TYPE:              Nonvolatile (SEE)

08, 0C, 10, 14, 18, 1C, 20, 24, 28, 2Ch	$2^{15}$	$2^{14}$	$2^{13}$	$2^{12}$	$2^{11}$	$2^{10}$	$2^9$	$2^8$
09, 0D, 11, 15, 19, 1D, 21, 25, 29, 2Dh	$2^7$	$2^6$	$2^5$	$2^4$	$2^3$	$2^2$	$2^1$	$2^0$
	bit7							bit0

Voltage measurement updates above this unsigned threshold will set its corresponding alarm or warning bit.  
 Voltage measurements equal to or below this threshold will clear its alarm or warning bit.

# PON Triplexer Control and Monitoring Circuit

- Lower Memory, Register 0Ah to 0Bh: V<sub>CC</sub> Alarm Lo
- Lower Memory, Register 0Eh to 0Fh: V<sub>CC</sub> Warn Lo
- Lower Memory, Register 12h to 13h: MON1 Alarm Lo
- Lower Memory, Register 16h to 17h: MON1 Warn Lo
- Lower Memory, Register 1Ah to 1Bh: MON2 Alarm Lo
- Lower Memory, Register 1Eh to 1Fh: MON2 Warn Lo
- Lower Memory, Register 22h to 23h: MON3 Alarm Lo
- Lower Memory, Register 26h to 27h: MON3 Warn Lo
- Lower Memory, Register 2Ah to 2Bh: MON4 Alarm Lo
- Lower Memory, Register 2Eh to 2Fh: MON4 Warn Lo

FACTORY DEFAULT:           0000h  
 READ ACCESS                All  
 WRITE ACCESS               PW2  
 MEMORY TYPE:              Nonvolatile (SEE)

0A, 0E, 12, 16, 1A, 1E, 22, 26, 2A, 2Eh	$2^{15}$	$2^{14}$	$2^{13}$	$2^{12}$	$2^{11}$	$2^{10}$	$2^9$	$2^8$
0B, 0F, 13, 17, 1B, 1F, 23, 27, 2B, 2Fh	$2^7$	$2^6$	$2^5$	$2^4$	$2^3$	$2^2$	$2^1$	$2^0$
	bit7							bit0

Voltage measurement updates above this unsigned threshold will set its corresponding alarm or warning bit.  
 Voltage measurements equal to or below this threshold will clear its alarm or warning bit.

### Lower Memory, Register 30h to 5Fh: PW2 EE

FACTORY DEFAULT:           00h  
 READ ACCESS                All  
 WRITE ACCESS               PW2  
 MEMORY TYPE:              Nonvolatile (EE)

30h to 5Fh	EE	EE	EE	EE	EE	EE	EE	EE
	bit7							bit0

PW2 level access controlled EEPROM.

# PON Triplexer Control and Monitoring Circuit

## Lower Memory, Register 60h to 61h: Temp Value

POWER-ON VALUE 0000h  
 READ ACCESS All  
 WRITE ACCESS N/A  
 MEMORY TYPE: Volatile

60h	S	$2^6$	$2^5$	$2^4$	$2^3$	$2^2$	$2^1$	$2^0$
61h	$2^{-1}$	$2^{-2}$	$2^{-3}$	$2^{-4}$	$2^{-5}$	$2^{-6}$	$2^{-7}$	$2^{-8}$
	bit7							bit0

Signed two's complement direct-to-temperature measurement.

## Lower Memory, Register 62h to 63h: V<sub>CC</sub> Value

### Lower Memory, Register 64h to 65h: MON1 Value

### Lower Memory, Register 66h to 67h: MON2 Value

### Lower Memory, Register 68h to 69h: MON3 Value

### Lower Memory, Register 6Ah to 6Bh: MON4 Value

POWER-ON VALUE 0000h  
 READ ACCESS All  
 WRITE ACCESS N/A  
 MEMORY TYPE: Volatile

62, 64, 66, 68, 6Ah	$2^{15}$	$2^{14}$	$2^{13}$	$2^{12}$	$2^{11}$	$2^{10}$	$2^9$	$2^8$
63, 65, 67, 69, 6Bh	$2^7$	$2^6$	$2^5$	$2^4$	$2^3$	$2^2$	$2^1$	$2^0$
	bit7							bit0

Left-justified unsigned voltage measurement.

## Lower Memory, Register 6Ch to 6D: Reserved

POWER-ON VALUE 00h  
 READ ACCESS All  
 WRITE ACCESS N/A  
 MEMORY TYPE:

6C, 6Dh	0	0	0	0	00	0	0	0
	bit7							bit0

These registers are reserved. The value when read is 00h.



# PON Triplexer Control and Monitoring Circuit

## Lower Memory, Register 6Eh: Status

POWER-ON VALUE                    x000 0x0x b  
 READ ACCESS                        All  
 WRITE ACCESS                        See Below  
 MEMORY TYPE:                        Volatile

Write Access	N/A	ALL	N/A	ALL	ALL	N/A	N/A	N/A	
6Eh	FETG STATUS	SOFT FETG	RESERVED	TX-F RESET	SOFT TX-D	TX-F STATUS	LOS STATUS	RDYB	
	bit7								bit0

bit7	<p><b>FETG STATUS:</b> Reflects the active state of FETG. The FETG-DIR bit in Table 02h, Register 89h defines the polarity of FETG.</p> <p>0 = Normal operation. Bias and modulation outputs are enabled.</p> <p>1 = The FETG output is active. Bias and modulation outputs are disabled.</p>
bit6	<p><b>SOFT FETG:</b></p> <p>0 = (Default)</p> <p>1 = Forces the bias and modulation outputs to their off states and asserts the FETG output.</p>
bit5	<p><b>RESERVED</b> (Default = 0)</p>
bit4	<p><b>TX-F RESET:</b></p> <p>0 = Does not affect the TX-F output. (Default)</p> <p>1 = Resets the latch for the TX-F output. This bit is self-clearing after the reset.</p>
bit3	<p><b>SOFT TX-D:</b> This bit allows a software control is identical to the TX-D pin. See the section on TX-D for further information. Its value is wired-ORed with the logic value of the TX-D pin.</p> <p>0 = Internal TX-D signal is equal to external TX-D pin.</p> <p>1 = Internal TX-D signal is high.</p>
bit2	<p><b>TX-F STATUS:</b> Reflects the active state of TX-F.</p> <p>0 = TX-F pin is not active.</p> <p>1 = TX-F pin is active.</p>
bit1	<p><b>LOS STATUS:</b> Loss of Signal. Reflects the logic level of the D0 input pin. Note that with the use of the MUX LOSI and INV LOSI bits (Table 02h, Register C0h), the D0 pin is controlled by the LOSI pin.</p> <p>0 = D0 is logic-low.</p> <p>1 = D0 is logic-high.</p>
bit0	<p><b>RDYB:</b> Ready Bar.</p> <p>0 = V<sub>CC</sub> is above POA.</p> <p>1 = V<sub>CC</sub> is below POA or too low to communicate over the I<sup>2</sup>C bus.</p>

# PON Triplexer Control and Monitoring Circuit

## Lower Memory, Register 6Fh: Update

POWER-ON VALUE	00h
READ ACCESS	All
WRITE ACCESS	All + DS1865 Hardware
MEMORY TYPE:	Volatile

6Fh	TEMP RDY	V <sub>CC</sub> RDY	MON1 RDY	MON2 RDY	MON3 RDY	MON4 RDY	RESERVED	RESERVED
	bit7							bit0

Update of completed conversions. At power-on, these bits are cleared and are set as each conversion is completed. These bits can be cleared so that a completion of a new conversion is verified.

# PON Triplexer Control and Monitoring Circuit

## Lower Memory, Register 70h: Alarms

POWER-ON VALUE            10h  
 READ ACCESS                All  
 WRITE ACCESS              N/A  
 MEMORY TYPE:              Volatile

70h	TEMP HI	TEMP LO	V <sub>CC</sub> HI	V <sub>CC</sub> LO	MON1 HI	MON1 LO	MON2 HI	MON2 LO
	bit7				bit0			

bit7	<b>TEMP HI:</b> High Alarm Status for Temperature Measurement. 0 = (Default) Last measurement was equal to or below threshold setting. 1 = Last measurement was above threshold setting.
bit6	<b>TEMP LO:</b> Low Alarm Status for Temperature Measurement. 0 = (Default) Last measurement was equal to or above threshold setting. 1 = Last measurement was below threshold setting.
bit5	<b>V<sub>CC</sub> HI:</b> High Alarm Status for V <sub>CC</sub> Measurement. 0 = (Default) Last measurement was equal to or below threshold setting. 1 = Last measurement was above threshold setting.
bit4	<b>V<sub>CC</sub> LO:</b> Low Alarm Status for V <sub>CC</sub> Measurement. This bit is set when the V <sub>CC</sub> supply is below the POA trip point value. It will clear itself when a V <sub>CC</sub> measurement is completed and the value is above the low threshold. 0 = Last measurement was equal to or above threshold setting. 1 = (Default) Last measurement was below threshold setting.
bit3	<b>MON1 HI:</b> High Alarm Status for MON1 Measurement. 0 = (Default) Last measurement was equal to or below threshold setting. 1 = Last measurement was above threshold setting.
bit2	<b>MON1 LO:</b> Low Alarm Status for MON1 Measurement. 0 = (Default) Last measurement was equal to or above threshold setting. 1 = Last measurement was below threshold setting.
bit1	<b>MON2 HI:</b> High Alarm Status for MON2 Measurement. 0 = (Default) Last measurement was equal to or below threshold setting. 1 = Last measurement was above threshold setting.
bit0	<b>MON2 LO:</b> Low Alarm Status for MON2 Measurement. 0 = (Default) Last measurement was equal to or above threshold setting. 1 = Last measurement was below threshold setting.

# PON Triplexer Control and Monitoring Circuit

## Lower Memory, Register 71h: Alarm<sub>2</sub>

POWER-ON VALUE            00h  
 READ ACCESS                All  
 WRITE ACCESS               N/A  
 MEMORY TYPE:                Volatile

71h	MON3 HI	MON3 LO	MON4 HI	MON4 LO	RESERVED	RESERVED	RESERVED	RESERVED
	bit7				bit0			

bit7	<b>MON3 HI:</b> High Alarm Status for MON3 Measurement. 0 = (Default) Last measurement was equal to or below threshold setting. 1 = Last measurement was above threshold setting.
bit6	<b>MON3 LO:</b> Low Alarm Status for MON3 Measurement. 0 = (Default) Last measurement was equal to or above threshold setting. 1 = Last measurement was below threshold setting.
bit5	<b>MON4 HI:</b> High Alarm Status for MON4 Measurement. 0 = (Default) Last measurement was equal to or below threshold setting. 1 = Last measurement was above threshold setting.
bit4	<b>MON4 LO:</b> Low Alarm Status for MON4 Measurement. 0 = (Default) Last measurement was equal to or above threshold setting. 1 = Last measurement was below threshold setting.
bit3:0	<b>RESERVED</b>

## Lower Memory, Register 72h: Alarm<sub>1</sub>

POWER-ON VALUE            00h  
 READ ACCESS                All  
 WRITE ACCESS               N/A  
 MEMORY TYPE:                Volatile

72h	RESERVED	RESERVED	RESERVED	RESERVED	BIAS HI	RESERVED	TXP HI	TXP LO
	bit7				bit0			

bit7:4	<b>RESERVED</b>
bit3	<b>BIAS HI:</b> High Alarm Status Bias; Fast Comparison. 0 = (Default) Last comparison was below threshold setting. 1 = Last comparison was above threshold setting.
bit2	<b>RESERVED</b>
bit1	<b>TXP HI:</b> High Alarm Status TX-P; Fast Comparison. 0 = (Default) Last comparison was below threshold setting. 1 = Last comparison was above threshold setting.
bit0	<b>TXP LO:</b> Low Alarm Status TX-P; Fast Comparison. 0 = (Default) Last comparison was above threshold setting. 1 = Last comparison was below threshold setting.

# PON Triplexer Control and Monitoring Circuit

## Lower Memory, Register 73h: Alarm

POWER-ON VALUE            00h  
 READ ACCESS                All  
 WRITE ACCESS               N/A  
 MEMORY TYPE:                Volatile

73h	RESERVED	RESERVED	RESERVED	RESERVED	BIAS MAX	RESERVED	RESERVED	RESERVED
	bit7					bit0		

bit7:4	<b>RESERVED</b>
bit3	<b>BIAS MAX:</b> Alarm Status for Maximum Digital Setting of IBIAS. 0 = (Default) The value for IBIAS is equal to or below the MAX IBIAS setting. 1 = Requested value for IBIAS is greater than the MAX IBIAS setting.
bit2:0	<b>RESERVED</b>

# PON Triplexer Control and Monitoring Circuit

## Lower Memory, Register 74h: Warn<sub>3</sub>

POWER-ON VALUE                    10h  
 READ ACCESS                        All  
 WRITE ACCESS                      N/A  
 MEMORY TYPE:                      Volatile

74h	TEMP HI	TEMP LO	V <sub>CC</sub> HI	V <sub>CC</sub> LO	MON1 HI	MON1 LO	MON2 HI	MON2 LO
	bit7				bit0			

bit7	<p><b>TEMP HI:</b> High Warning Status for Temperature Measurement.          0 = (Default) Last measurement was equal to or below threshold setting.          1 = Last measurement was above threshold setting.</p>
bit6	<p><b>TEMP LO:</b> Low Warning Status for Temperature Measurement.          0 = (Default) Last measurement was equal to or above threshold setting.          1 = Last measurement was below threshold setting.</p>
bit5	<p><b>V<sub>CC</sub> HI:</b> High Warning Status for V<sub>CC</sub> Measurement.          0 = (Default) Last measurement was equal to or below threshold setting.          1 = Last measurement was above threshold setting.</p>
bit4	<p><b>V<sub>CC</sub> LO:</b> Low Warning Status for V<sub>CC</sub> Measurement. This bit is set when the V<sub>CC</sub> supply is below the POA trip point value. It will clear itself when a V<sub>CC</sub> measurement is completed and the value is above the low threshold.          0 = Last measurement was equal to or above threshold setting.          1 = (Default) Last measurement was below threshold setting.</p>
bit3	<p><b>MON1 HI:</b> High Warning Status for MON1 Measurement.          0 = (Default) Last measurement was equal to or below threshold setting.          1 = Last measurement was above threshold setting.</p>
bit2	<p><b>MON1 LO:</b> Low Warning Status for MON1 Measurement.          0 = (Default) Last measurement was equal to or above threshold setting.          1 = Last measurement was below threshold setting.</p>
bit1	<p><b>MON2 HI:</b> High Warning Status for MON2 Measurement.          0 = (Default) Last measurement was equal to or below threshold setting.          1 = Last measurement was above threshold setting.</p>
bit0	<p><b>MON2 LO:</b> Low Warning Status for MON2 Measurement.          0 = (Default) Last measurement was equal to or above threshold setting.          1 = Last measurement was below threshold setting.</p>

# PON Triplexer Control and Monitoring Circuit

## Lower Memory, Register 75h: Warn2

POWER-ON VALUE            00h  
 READ ACCESS                All  
 WRITE ACCESS               N/A  
 MEMORY TYPE:                Volatile

75h	MON3 HI	MON3 LO	MON4 HI	MON4 LO	RESERVED	RESERVED	RESERVED	RESERVED
	bit7				bit0			

bit7	<b>MON3 HI:</b> High Warning Status for MON3 Measurement. 0 = (Default) Last measurement was equal to or below threshold setting. 1 = Last measurement was above threshold setting.
bit6	<b>MON3 LO:</b> Low Warning Status for MON3 Measurement. 0 = (Default) Last measurement was equal to or above threshold setting. 1 = Last measurement was below threshold setting.
bit5	<b>MON4 HI:</b> High Warning Status for MON4 Measurement. 0 = (Default) Last measurement was equal to or below threshold setting. 1 = Last measurement was above threshold setting.
bit4	<b>MON4 LO:</b> Low Warning Status for MON4 Measurement. 0 = (Default) Last measurement was equal to or above threshold setting. 1 = Last measurement was below threshold setting.
bit3:0	<b>RESERVED</b>

## Lower Memory, Register 76h to 77h: Reserved

POWER-ON VALUE            00h  
 READ ACCESS                All  
 WRITE ACCESS               N/A  
 MEMORY TYPE:

76, 77h	0	0	0	0	00	0	0	0
	bit7				bit0			

These registers are reserved. The value when read is 00h.

# PON Triplexer Control and Monitoring Circuit

## Lower Memory, Register 78h: DOUT

POWER-ON VALUE                      Recalled from Table 02h, Register C0h  
 READ ACCESS                              All  
 WRITE ACCESS                             All  
 MEMORY TYPE:                             Volatile

78h	RESERVED	RESERVED	RESERVED	RESERVED	D3 OUT	D2 OUT	D1 OUT	D0 OUT
	bit7							bit0

At power-on, these bits are defined by the value stored in the DPU byte (Table 02h, Register C0h). These bits define the value of the logic states of their corresponding output pins.

## Lower Memory, Register 79h: DIN

POWER-ON VALUE                      See description  
 READ ACCESS                              All  
 WRITE ACCESS                             N/A  
 MEMORY TYPE:                             Volatile

79h	RESERVED	RESERVED	INV LOSI	MUX LOSI	D3 IN	D2 IN	D1 IN	D0 IN
	bit7							bit0

bit7:6	<b>RESERVED</b>
bit5	<b>INV LOSI:</b> Allows for inversion of LOSI pin to D0 pin. MUX LOSI bit must be set to 1 or this bit does not affect the output. This bit is controlled (or set) by the DPU byte (Table 02h, Register C0h). 1 = LOS buffered OUT <sub>0</sub> is inverted.
bit4	<b>MUX LOSI:</b> Determines control of D0 pin. This bit is controlled (or set) by the DPU byte (Table 02h, Register C0h). 0 = Logic value of D0 is controlled by DOUT byte. 1 = Logic value of D0 is controlled by LOSI pin and INV LOSI bit.
bit3	<b>D3 IN:</b> Reflects the logic value of D3 pin.
bit2	<b>D2 IN:</b> Reflects the logic value of D2 pin.
bit1	<b>D1 IN:</b> Reflects the logic value of D1 pin.
bit0	<b>D0 IN:</b> Reflects the logic value of D0 pin.

## Lower Memory, Register 7Ah: Reserved

POWER-ON VALUE                      00h  
 READ ACCESS                              All  
 WRITE ACCESS                             N/A  
 MEMORY TYPE:

7Ah	0	0	0	0	00	0	0	0
	bit7							bit0

This register is reserved. The value when read is 00h.



# PON Triplexer Control and Monitoring Circuit

## Lower Memory, Register 7Bh to 7Eh: Password Entry (PWE)

POWER-ON VALUE            FFFF FFFFh  
 READ ACCESS                N/A  
 WRITE ACCESS               All  
 MEMORY TYPE:                Volatile

7Bh	$2^{31}$	$2^{30}$	$2^{29}$	$2^{28}$	$2^{27}$	$2^{26}$	$2^{25}$	$2^{24}$
7Ch	$2^{23}$	$2^{22}$	$2^{21}$	$2^{20}$	$2^{19}$	$2^{18}$	$2^{17}$	$2^{16}$
7Dh	$2^{15}$	$2^{14}$	$2^{13}$	$2^{12}$	$2^{11}$	$2^{10}$	$2^9$	$2^8$
7Eh	$2^7$	$2^6$	$2^5$	$2^4$	$2^3$	$2^2$	$2^1$	$2^0$
	bit7							bit0

Password Entry. There are two passwords for the DS1865. Each password is 4 bytes long. The lower level password (PW1) will have access to all unprotected areas plus those made available with PW1. The higher level password (PW2) will have all the access of PW1 plus those made available with PW2. The values of the passwords reside in EEPROM inside of PW2 memory. At power-up, all PWE bits are set to 1. All reads at this location are 0.

## Lower Memory, Register 7Fh: Table Select (TBL SEL)

POWER-ON VALUE            00h  
 READ ACCESS                All  
 WRITE ACCESS               All  
 MEMORY TYPE                Volatile

7Fh	$2^7$	$2^6$	$2^5$	$2^4$	$2^3$	$2^2$	$2^1$	$2^0$
	bit7							bit0

The upper memory tables (Table 01h–06h) of the DS1865 are accessible by writing the desired table value in this register.

# PON Triplexer Control and Monitoring Circuit

## Table 01h Register Descriptions

**Table 01h, Register 80h to F7h: PW1 EEPROM**

POWER-ON VALUE            00h  
 READ ACCESS                PW1  
 WRITE ACCESS               PW1  
 MEMORY TYPE                Nonvolatile (EE)

80h-F7h	EE	EE	EE	EE	EE	EE	EE	EE
	bit7							bit0

EEPROM for PW1 level access.

**Table 01h, Register F8h: Alarm3**

POWER-ON VALUE            00h  
 READ ACCESS                All  
 WRITE ACCESS               PW1  
 MEMORY TYPE:                Volatile

F8h	TEMP HI	TEMP LO	V <sub>CC</sub> HI	V <sub>CC</sub> LO	MON1 HI	MON1 LO	MON2 HI	MON2 LO
	bit7							bit0

Layout is identical to Alarm3 in Lower Memory, Register 70h with two exceptions.

1. V<sub>CC</sub> low alarm is not set at power-on.
2. These bits are latched. They are cleared by power-down or a write with PW1 access.

**Table 01h, Register F9h: Alarm2**

POWER-ON VALUE            00h  
 READ ACCESS                All  
 WRITE ACCESS               PW1  
 MEMORY TYPE:                Volatile

F9h	MON3 HI	MON3 LO	MON4 HI	MON4 LO	RESERVED	RESERVED	RESERVED	RESERVED
	bit7							bit0

Layout is identical to Alarm2 in Lower Memory, Register 71h with one exception.

1. These bits are latched. They are cleared by power-down or a write with PW1 access.

# PON Triplexer Control and Monitoring Circuit

**Table 01h, Register FAh: Alarm<sub>1</sub>**

POWER-ON VALUE            00h  
 READ ACCESS                All  
 WRITE ACCESS               PW1  
 MEMORY TYPE:                Volatile

FAh	RESERVED	RESERVED	RESERVED	BIAS HI	RESERVED	RESERVED	TXP HI	TXP LO
	bit7							bit0

Layout is identical to Alarm<sub>1</sub> in Lower Memory, Register 72h with one exception.

1. These bits are latched. They are cleared by power-down or a write with PW1 access.

**Table 01h, Register FBh: Alarm<sub>0</sub>**

POWER-ON VALUE            00h  
 READ ACCESS                All  
 WRITE ACCESS               PW1  
 MEMORY TYPE:                Volatile

FBh	RESERVED	RESERVED	RESERVED	RESERVED	BIAS MAX	RESERVED	RESERVED	RESERVED
	bit7							bit0

Layout is identical to Alarm<sub>0</sub> in Lower Memory, Register 73h with one exception.

1. These bits are latched. They are cleared by power-down or a write with PW1 access.

**Table 01h, Register FCh: Warn<sub>3</sub>**

POWER-ON VALUE            00h  
 READ ACCESS                All  
 WRITE ACCESS               PW1  
 MEMORY TYPE:                Volatile

FCh	TEMP HI	TEMP LO	V <sub>CC</sub> HI	V <sub>CC</sub> LO	MON1 HI	MON1 LO	MON2 HI	MON2 LO
	bit7							bit0

Layout is identical to Warn<sub>3</sub> in Lower Memory, Register 74h with two exceptions.

1. V<sub>CC</sub> Low Warning is not set at power-on.
2. These bits are latched. They are cleared by power-down or a write with PW1 access.

# PON Triplexer Control and Monitoring Circuit

**Table 01h, Register FDh: Warn<sub>2</sub>**

POWER-ON VALUE            00h  
 READ ACCESS                All  
 WRITE ACCESS              PW1  
 MEMORY TYPE:              Volatile

FDh	MON3 HI	MON3 LO	MON4 HI	MON4 LO	RESERVED	RESERVED	RESERVED	RESERVED
	bit7				bit0			

Layout is identical to Warn<sub>2</sub> in Lower Memory, Register 75h with one exception.

1. These bits are latched. They are cleared by power-down or a write with PW1 access.

**Table 01h, Register FEh to FFh: Reserved**

POWER-ON VALUE            00h  
 READ ACCESS                All  
 WRITE ACCESS              PW1  
 MEMORY TYPE:              Volatile

These registers are reserved.

# PON Triplexer Control and Monitoring Circuit

**Table 02h Register Descriptions**

**Table 02h, Register 80h: Mode**

POWER-ON VALUE            1Fh  
 READ ACCESS                PW2  
 WRITE ACCESS               PW2  
 MEMORY TYPE:                Volatile

80h	SEEB	RESERVED	RESERVED	M4DAC-EN	AEN	MOD-EN	APC-EN	BIAS-EN
	bit7							bit0

bit7	<p><b>SEEB:</b>          0 = (Default) Enables EEPROM writes to SEE bytes.          1 = Disables EEPROM writes to SEE bytes during configuration, so that the configuration of the part is not delayed by the EE cycle time. Once the values are known, write this bit to a 0 and write the SEE locations again for data to be written to the EEPROM.</p>
bit6:5	<p><b>RESERVED</b></p>
bit4	<p><b>M4DAC-EN:</b>          0 = M4DAC is writeable by the user and the LUT recalls are disabled. This allows users to interactively test their modules by writing the DAC value for M4DAC. The output is updated with the new value at the end of the write cycle. The I<sup>2</sup>C STOP condition is the end of the write cycle.          1 = (Default) Enables auto control of the LUT for M4DAC.</p>
bit3	<p><b>AEN:</b>          0 = The temperature-calculated index value (T INDEX) is writeable by the user and the updates of calculated indexes are disabled. This allows users to interactively test their modules by controlling the indexing for the lookup tables. The recalled values from the LUTs will appear in the DAC registers after the next completion of a temperature conversion (just like it would happen in auto mode). Both DACs will update at the same time (just like in auto mode).          1 = (Default) Enables auto control of the LUT.</p>
bit2	<p><b>MOD-EN:</b>          0 = MOD DAC is writeable by the user and the LUT recalls are disabled. This allows users to interactively test their modules by writing the DAC value for modulation. The output is updated with the new value at the end of the write cycle. The I<sup>2</sup>C STOP condition is the end of the write cycle.          1 = (Default) Enables auto control of the LUT for modulation.</p>
bit1	<p><b>APC-EN:</b>          0 = APC DAC is writeable by the user and the LUT recalls are disabled. This allows users to interactively test their modules by writing the DAC value for APC reference. The output is updated with the new value at the end of the write cycle. The I<sup>2</sup>C STOP condition is the end of the write cycle.          1 = (Default) Enables auto control of the LUT for APC reference.</p>
bit0	<p><b>BIAS-EN:</b>          0 = BIAS DAC is controlled by the user and the APC is open loop. The BIAS DAC value is written to the MAN IBIAS register. All values that are written to MAN IBIAS and are greater than the MAX IBIAS register setting are not updated and will set the BIAS MAX alarm bit. The BIAS DAC register will continue to reflect the value of the BIAS DAC. This allows users to interactively test their modules by writing the DAC value for IBIAS. The output is updated with the new value at the end of the write cycle to the MAN IBIAS register. The I<sup>2</sup>C STOP condition is the end of the write cycle.          1 = (Default) Enables auto control for the APC feedback.</p>

# PON Triplexer Control and Monitoring Circuit

**Table 02h, Register 81h: Tindex**

POWER-ON VALUE	00h
READ ACCESS	PW2
WRITE ACCESS	PW2 and (AEN = 0)
MEMORY TYPE	Volatile

81h	$2^7$	$2^6$	$2^5$	$2^4$	$2^3$	$2^2$	$2^1$	$2^0$
	bit7							bit0

Holds the calculated index based on the Temperature Measurement. This index is used for the address during lookup of tables 04h and 05h. Temperature measurements below -40°C or above 102°C are clamped to 00h and C7h, respectively. The calculation of Tindex is as follows:

$$\text{Tindex} = \frac{\text{Temp} + 40^\circ\text{C}}{2^\circ\text{C}} + 80\text{h}$$

For the two temperature-indexed LUTs, the index used during the lookup function for each table is as follows:

Table 04h MOD	1	Tindex <sub>6</sub>	Tindex <sub>5</sub>	Tindex <sub>4</sub>	Tindex <sub>3</sub>	Tindex <sub>2</sub>	Tindex <sub>1</sub>	Tindex <sub>0</sub>
Table 05h APC	1	0	Tindex <sub>6</sub>	Tindex <sub>5</sub>	Tindex <sub>4</sub>	Tindex <sub>3</sub>	Tindex <sub>2</sub>	Tindex <sub>1</sub>

**Table 02h, Register 82h: MOD DAC**

POWER-ON VALUE	00h
READ ACCESS	PW2
WRITE ACCESS	PW2 and (MOD-EN = 0)
MEMORY TYPE	Volatile

82h	$2^7$	$2^6$	$2^5$	$2^4$	$2^3$	$2^2$	$2^1$	$2^0$
	bit7							bit0

The digital value used for MOD and recalled from Table 04h at the adjusted memory address is found in Tindex. (R.O.) This register is updated at the end of every temperature conversion.

**Table 02h, Register 83h: APC DAC**

POWER-ON VALUE	00h
READ ACCESS	PW2
WRITE ACCESS	PW2 and (APC-EN = 0)
MEMORY TYPE	Volatile

83h	$2^7$	$2^6$	$2^5$	$2^4$	$2^3$	$2^2$	$2^1$	$2^0$
	bit7							bit0

The digital value used for APC reference and recalled from Table 05h at the adjusted memory address found in Tindex. (R.O.) This register is updated at the end of the temperature conversion.

# PON Triplexer Control and Monitoring Circuit

**Table 02h, Register 84h: Vindex**

FACTORY DEFAULT            00h  
 READ ACCESS                PW2  
 WRITE ACCESS               PW2 and (AEN = 0)  
 MEMORY TYPE                Volatile

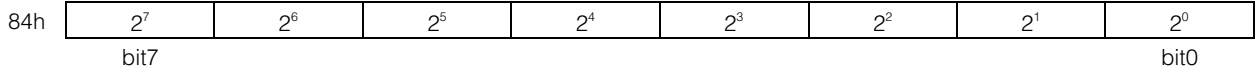

Holds the calculated index based on the MON4 voltage measurement. This index is used for the address during lookup of Table 06h. M4DAC LUT (Table 06h) is 32 bytes from address 80h to 9Fh. The calculation of Vindex is as follows:

$$Vindex = \frac{Mon4}{800h} + 80h$$

When configured as a single LUT, all 32 bytes are used for lookup.

When configured as a double LUT, the first 16 bytes (80h-8Fh) form the lower LUT and the last 16 bytes (90h-9Fh) form the upper LUT. For the three different modes, the index used during the lookup function of Table 06h is as follows:

Single	1	0	0	Vindex <sub>4</sub>	Vindex <sub>3</sub>	Vindex <sub>2</sub>	Vindex <sub>1</sub>	Vindex <sub>0</sub>
Double / Lower	1	0	0	0	Vindex <sub>4</sub>	Vindex <sub>3</sub>	Vindex <sub>2</sub>	Vindex <sub>1</sub>
Double / Upper	1	0	0	1	Vindex <sub>4</sub>	Vindex <sub>3</sub>	Vindex <sub>2</sub>	Vindex <sub>1</sub>

**Table 02h, Register 85h: M4DAC**

FACTORY DEFAULT            00 00h  
 READ ACCESS                PW2  
 WRITE ACCESS               PW2 and (M4DAC-EN = 0)  
 MEMORY TYPE:                Volatile

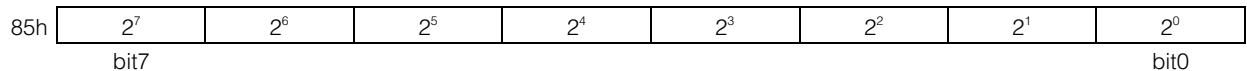

The digital value used for M4DAC and recalled from Table 06h at the adjusted memory address is found in Vindex. (R.O.) This register is updated at the end of the MON4 conversion.

**Table 02h, Register 86h: Device ID**

FACTORY DEFAULT            65h  
 READ ACCESS                PW2  
 WRITE ACCESS               N/A  
 MEMORY TYPE                ROM

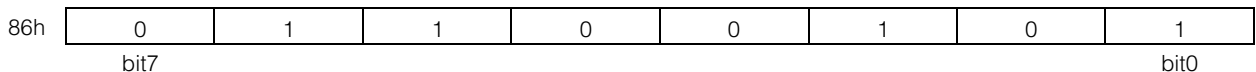

Hardwired connections to show device ID.

# PON Triplexer Control and Monitoring Circuit

**Table 02h, Register 87h: Device VER**

FACTORY DEFAULT	Device Version
READ ACCESS	PW2
WRITE ACCESS	N/A
MEMORY TYPE	ROM



Hardwired connections to show device version.

**Table 02h, Register 88h: Update Rate**

FACTORY DEFAULT	00h
READ ACCESS	PW2
WRITE ACCESS	PW2
MEMORY TYPE	Nonvolatile (SEE)

Defines the update rate for comparison of APC control.

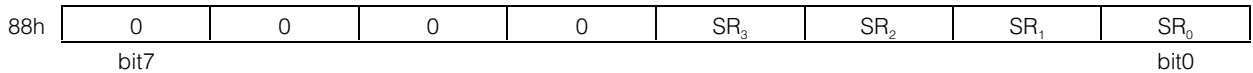

bit7:4	<b>0:</b>
bit3:0	<b>SR(3:0):</b> 4-bit sample rate for comparison of APC control.

BIT SR <sub>3</sub> –SR <sub>0</sub>	MINIMUM TIME FROM BEN TO FIRST SAMPLE (t <sub>FIRST</sub> ) ±50ns	REPEATED SAMPLE PERIOD FOLLOWING FIRST SAMPLE (t <sub>REP</sub> )
0000b	350ns	800ns
0001b	550ns	1200ns
0010b	750ns	1600ns
0011b	950ns	2000ns
0100b	1350ns	2800ns
0101b	1550ns	3200ns
0110b	1750ns	3600ns
0111b	2150ns	4400ns
1000b	2950ns	6000ns
*1001b	3150ns	6400ns

*\*All codes greater than 1001b (1010b–1111b) use the maximum sample time of code 1001b.*



# PON Triplexer Control and Monitoring Circuit

**Table 02h, Register 89h: Config**

FACTORY DEFAULT                    00h  
 READ ACCESS                        PW2  
 WRITE ACCESS                       PW2  
 MEMORY TYPE:                        Nonvolatile (SEE)

89h	FETG DIR	TX-F EN	RESERVED	ASEL	RESERVED	RESERVED	RESERVED	RESERVED
	bit7				bit0			

Configure the memory location and the polarity of the digital outputs.

bit7	<p><b>FETG DIR:</b> Chooses the direction or polarity of the FETG output for normal operation.</p> <p>0 = (Default) Under normal operation, FETG is pulled low. Intended for use with nMOS.</p> <p>1 = Under normal operation, FETG is pulled high. Intended for use with pMOS.</p>
bit6	<p><b>TX-F EN:</b> The TX-F output pin always reflects the wired-OR of all TXF enabled alarm states. This bit will enable the latching of the alarm state for the TXF output pin.</p> <p>0 = (Default) Not latched.</p> <p>1 = The alarm bits are latched until cleared by a TX-D transition or power-down. If <math>V_{CC\_Lo\_Alarm}</math> is enabled for either FETG or TX-F then latching is disabled until the after the first <math>V_{CC}</math> measurement is made above the <math>V_{CC\_Lo}</math> set point to allow for proper operation during slow power-on cycles.</p>
bit5	<b>RESERVED</b>
bit4	<p><b>ASEL:</b> Address Select.</p> <p>0 = (Default) Device Address of A2h.</p> <p>1 = I<sup>2</sup>C slave address is determined by the value programmed in the DEVICE ADDRESS byte (Table 02h, Register 8Ch).</p>
bit3:0	<b>RESERVED</b>

**Table 02h, Register 8Ah: Startup Step**

FACTORY DEFAULT:                    00h  
 READ ACCESS                        PW2  
 WRITE ACCESS                       PW2  
 MEMORY TYPE:                        Nonvolatile (SEE)

8Ah	$2^{12}$	$2^{11}$	$2^{10}$	$2^9$	$2^8$	$2^7$	$2^6$	$2^5$
	bit7				bit0			

This value will define the maximum allowed step for the upper 8 bits of I<sub>BIAS</sub> output during startup. Programming this value to 00h cause the device to take single LSB ( $2^0$ ) steps towards convergence. See the *BIAS and MOD Output During Power-Up* section for details.

# PON Triplexer Control and Monitoring Circuit

**Table 02h, Register 8Bh: MOD Ranging**

FACTORY DEFAULT: 00h  
 READ ACCESS PW2  
 WRITE ACCESS PW2  
 MEMORY TYPE: Nonvolatile (SEE)

8Bh	RESERVED	RESERVED	RESERVED	RESERVED	RESERVED	MOD <sub>2</sub>	MOD <sub>1</sub>	MOD <sub>0</sub>
	bit7					bit0		

The lower nibble of this byte controls the full-scale range of the modulation DAC.

bit7:3	<b>RESERVED</b> (Default = 0)
bit2:0	<b>MOD<sub>2</sub>, MOD<sub>1</sub>, MOD<sub>0</sub>: MOD FS Ranging.</b> 3-bit value to select the FS output voltage for VMOD. Default is 000b and creates a FS of 1.25V.

MOD <sub>2</sub> – MOD <sub>0</sub>	% OF 1.25V	FS VOLTAGE (V)
000b	100.00	1.250
001b	80.05	1.001
010b	66.75	0.833
011b	50.13	0.627
100b	40.16	0.502
101b	33.50	0.419
110b	28.75	0.359
111b	25.18	0.315

**Table 02h, Register 8Ch: Device Address**

FACTORY DEFAULT: 00h  
 READ ACCESS PW2  
 WRITE ACCESS PW2  
 MEMORY TYPE: Nonvolatile (SEE)

8Ch	2 <sup>7</sup>	2 <sup>6</sup>	2 <sup>5</sup>	2 <sup>4</sup>	2 <sup>3</sup>	2 <sup>2</sup>	2 <sup>1</sup>	2 <sup>0</sup>
	bit7							bit0

This value becomes the I<sup>2</sup>C slave address for the main memory when the ASEL bit (Table 02h, Register 89h) is set.

# PON Triplexer Control and Monitoring Circuit

**Table 02h, Register 8Dh: Comp Ranging**

FACTORY DEFAULT:           00h  
 READ ACCESS                PW2  
 WRITE ACCESS               PW2  
 MEMORY TYPE:               Nonvolatile (SEE)

8Dh	RESERVED	BIAS <sub>2</sub>	BIAS <sub>1</sub>	BIAS <sub>0</sub>	RESERVED	APC <sub>2</sub>	APC <sub>1</sub>	APC <sub>0</sub>
	bit7				bit0			

The upper nibble of this byte controls the Full-Scale range of the Quick-Trip monitoring for BIAS. The Lower nibble of this byte controls the Full-Scale range for the Quick-Trip monitoring of the APC reference as well as the closed loop monitoring of APC.

bit7	<b>RESERVED</b> (Default = 0)
bit6.4	<b>BIAS<sub>2</sub>, BIAS<sub>1</sub>, BIAS<sub>0</sub>: BIAS FS Ranging:</b> 3-bit value to select the FS comparison voltage for BIAS found on MON1. Default is 000b and creates an FS of 1.25V.
bit3	<b>RESERVED</b> (Default = 0)
bit2:0	<b>APC<sub>2</sub>, APC<sub>1</sub>, APC<sub>0</sub>: APC FS Ranging:</b> 3-bit value to select the FS comparison voltage for BMD with the APC. Default is 000b and creates an FS of 2.5V.

BIAS <sub>2</sub> – BIAS <sub>0</sub>	% OF 1.25V	FS VOLTAGE (V)
000b	100.00	1.250
001b	80.10	1.001
010b	66.83	0.835
011b	50.25	0.628
100b	40.30	0.504
101b	33.66	0.421
110b	28.92	0.362
111b	25.39	0.317

APC <sub>2</sub> – APC <sub>0</sub>	% OF 2.50V	FS VOLTAGE (V)
000b	100.00	1.250
001b	80.10	1.001
010b	66.83	0.835
011b	50.25	0.628
100b	40.30	0.504
101b	33.66	0.421
110b	28.92	0.362
111b	25.39	0.317

# PON Triplexer Control and Monitoring Circuit

**Table 02h, Register 8Eh: Right Shift<sub>1</sub> (RSHIFT<sub>1</sub>)**

FACTORY DEFAULT: 00h  
 READ ACCESS PW2  
 WRITE ACCESS PW2  
 MEMORY TYPE: Nonvolatile (SEE)

8Eh	RESERVED	MON1 <sub>2</sub>	MON1 <sub>1</sub>	MON1 <sub>0</sub>	RESERVED	MON2 <sub>2</sub>	MON2 <sub>1</sub>	MON2 <sub>0</sub>
	bit7							bit0

Allows for right-shifting the final answer of MON1 and MON2 voltage measurements. This allows for scaling the measurements to the smallest full-scale voltage and then right-shifting the final result so the reading is weighted to the correct LSB. See the *Right Shifting ADC Results* section for details.

**Table 02h, Register 8Fh: Right Shift<sub>0</sub> (RSHIFT<sub>0</sub>)**

FACTORY DEFAULT: 00h  
 READ ACCESS PW2  
 WRITE ACCESS PW2  
 MEMORY TYPE: Nonvolatile (SEE)

8Fh	RESERVED	MON3 <sub>2</sub>	MON3 <sub>1</sub>	MON3 <sub>0</sub>	RESERVED	MON4 <sub>2</sub>	MON4 <sub>1</sub>	MON4 <sub>0</sub>
	bit7							bit0

Allows for right-shifting the final answer of MON3 and MON4 voltage measurements. This allows for scaling the measurements to the smallest full-scale voltage and then right-shifting the final result so the reading is weighted to the correct LSB. See the *Right Shifting ADC Results* section for details.

**Table 02h, Register 90h to 91h: Reserved**

FACTORY DEFAULT: 0000h  
 READ ACCESS PW2  
 WRITE ACCESS PW2  
 MEMORY TYPE: Nonvolatile (SEE)

These registers are reserved.

# PON Triplexer Control and Monitoring Circuit

- Table 02h, Register 92h to 93h: V<sub>CC</sub> Scale**
- Table 02h, Register 94h to 95h: MON1 Scale**
- Table 02h, Register 96h to 97h: MON2 Scale**
- Table 02h, Register 98h to 99h: MON3 Scale**
- Table 02h, Register 9Ah to 9Bh: MON4 Scale**

FACTORY CALIBRATED

READ ACCESS PW2

WRITE ACCESS PW2

MEMORY TYPE: Nonvolatile (SEE)

92, 94, 96, 98, 9Ah	2 <sup>15</sup>	2 <sup>14</sup>	2 <sup>13</sup>	2 <sup>12</sup>	2 <sup>11</sup>	2 <sup>10</sup>	2 <sup>9</sup>	2 <sup>8</sup>	
93, 95, 97, 99, 9Bh	2 <sup>7</sup>	2 <sup>6</sup>	2 <sup>5</sup>	2 <sup>4</sup>	2 <sup>3</sup>	2 <sup>2</sup>	2 <sup>1</sup>	2 <sup>0</sup>	
	bit7								bit0

Controls the scaling or gain of the FS voltage measurements. The factory-calibrated value produces an FS voltage of 6.5536V for V<sub>CC</sub> and 2.5V for MON1, MON2, MON3, and MON4.

**Table 02h, Register 9Ch to A1h: Reserved**

FACTORY DEFAULT: 0000h

READ ACCESS PW2

WRITE ACCESS PW2

MEMORY TYPE: Nonvolatile (SEE)

These registers are reserved.

- Table 02h, Register A2h to A3h: V<sub>CC</sub> Offset**
- Table 02h, Register A4h to A5h: MON1 Offset**
- Table 02h, Register A6h to A7h: MON2 Offset**
- Table 02h, Register A8h to A9h: MON3 Offset**
- Table 02h, Register AAh to ABh: MON4 Offset**

FACTORY DEFAULT: 0000h

READ ACCESS PW2

WRITE ACCESS PW2

MEMORY TYPE: Nonvolatile (SEE)

A2, A4, A6, A8, AAh	S	S	2 <sup>15</sup>	2 <sup>14</sup>	2 <sup>13</sup>	2 <sup>12</sup>	2 <sup>11</sup>	2 <sup>10</sup>	
A3, A5, A7, A9, ABh	2 <sup>9</sup>	2 <sup>8</sup>	2 <sup>7</sup>	2 <sup>6</sup>	2 <sup>5</sup>	2 <sup>4</sup>	2 <sup>3</sup>	2 <sup>2</sup>	
	bit7								bit0

Allows for offset control of these voltage measurements if desired.

# PON Triplexer Control and Monitoring Circuit

**Table 02h, Register ACh to ADh: Reserved**

FACTORY DEFAULT:	0000 0000h
READ ACCESS	PW2
WRITE ACCESS	PW2
MEMORY TYPE:	Nonvolatile (SEE)

These registers are reserved.

**Table 02h, Register AEh to AFh: Internal Temp Offset**

FACTORY CALIBRATED	
READ ACCESS	PW2
WRITE ACCESS	PW2
MEMORY TYPE	Nonvolatile (SEE)

AEh	S	$2^8$	$2^7$	$2^6$	$2^5$	$2^4$	$2^3$	$2^2$
AFh	$2^1$	$2^0$	$2^{-1}$	$2^{-2}$	$2^{-3}$	$2^{-4}$	$2^{-5}$	$2^{-6}$
	bit7			bit0				

Allows for offset control of the temperature measurement if desired. The final result must be XORed with BB40h before writing to this register. Factory calibration contains the desired value for a reading in degrees Celsius.

**Table 02h, Register B0h to B3h: PW1**

FACTORY DEFAULT	FFFF FFFFh
READ ACCESS	N/A
WRITE ACCESS	PW2
MEMORY TYPE	Nonvolatile (SEE)

B0h	$2^{31}$	$2^{30}$	$2^{29}$	$2^{28}$	$2^{27}$	$2^{26}$	$2^{25}$	$2^{24}$
B1h	$2^{23}$	$2^{22}$	$2^{21}$	$2^{20}$	$2^{19}$	$2^{18}$	$2^{17}$	$2^{16}$
B2h	$2^{15}$	$2^{14}$	$2^{13}$	$2^{12}$	$2^{11}$	$2^{10}$	$2^9$	$2^8$
B3h	$2^7$	$2^6$	$2^5$	$2^4$	$2^3$	$2^2$	$2^1$	$2^0$
	bit7			bit0				

The PWE value is compared against the value written to this location to enable PW1 access. At power-on, the PWE value is set to all ones. Thus, writing these bytes to all ones grants PW1 access on power-up without writing the password entry. All reads of this register are 00h.

# PON Triplexer Control and Monitoring Circuit

**Table 02h, Register B4h to B7h: PW2**

FACTORY DEFAULT                      FFFF FFFFh  
 READ ACCESS                            N/A  
 WRITE ACCESS                          PW2  
 MEMORY TYPE                          Nonvolatile (SEE)

B4h	$2^{31}$	$2^{30}$	$2^{29}$	$2^{28}$	$2^{27}$	$2^{26}$	$2^{25}$	$2^{24}$	
B5h	$2^{23}$	$2^{22}$	$2^{21}$	$2^{20}$	$2^{19}$	$2^{18}$	$2^{17}$	$2^{16}$	
B6h	$2^{15}$	$2^{14}$	$2^{13}$	$2^{12}$	$2^{11}$	$2^{10}$	$2^9$	$2^8$	
B7h	$2^7$	$2^6$	$2^5$	$2^4$	$2^3$	$2^2$	$2^1$	$2^0$	
	bit7						bit0		

The PWE value is compared against the value written to this location to enable PW2 access. At power-on, the PWE value is set to all ones. Thus, writing these bytes to all ones grants PW2 access on power-up without writing the password entry. All reads of this register are 00h.

# PON Triplexer Control and Monitoring Circuit

**Table 02h, Register B8h: FETG Enable<sub>1</sub> (FETG EN<sub>1</sub>)**

FACTORY DEFAULT                    00h  
 READ ACCESS                        PW2  
 WRITE ACCESS                       PW2  
 MEMORY TYPE:                       Nonvolatile (SEE)

B8h	TEMP EN	V <sub>CC</sub> EN	MON1 EN	MON2 EN	MON3 EN	MON4 EN	RESERVED	RESERVED
	bit7						bit0	

Configures the maskable interrupt for the FETG pin.

bit7	<b>TEMP EN:</b> Enables/disables active interrupts on the FETG pin due to temperature measurements outside the threshold limits. 0 = Disable (Default). 1 = Enable.
bit6	<b>V<sub>CC</sub> EN:</b> Enables/disables active interrupts on the FETG pin due to V <sub>CC</sub> measurements outside the threshold limits. 0 = Disable (Default). 1 = Enable.
bit5	<b>MON1 EN:</b> Enables/disables active interrupts on the FETG pin due to MON1 measurements outside the threshold limits. 0 = Disable (Default). 1 = Enable.
bit4	<b>MON2 EN:</b> Enables/disables active interrupts on the FETG pin due to MON2 measurements outside the threshold limits. 0 = Disable (Default). 1 = Enable.
bit3	<b>MON3 EN:</b> Enables/disables active interrupts on the FETG pin due to MON3 measurements outside the threshold limits. 0 = Disable (Default). 1 = Enable.
bit2	<b>MON4 EN:</b> Enables/disables active interrupts on the FETG pin due to MON4 measurements outside the threshold limits. 0 = Disable (Default). 1 = Enable.
bit1:0	<b>RESERVED</b> (Default = 0)



# PON Triplexer Control and Monitoring Circuit

**Table 02h, Register B9h: FETG Enable<sub>0</sub> (FETG EN<sub>0</sub>)**

FACTORY DEFAULT                    00h  
 READ ACCESS                        PW2  
 WRITE ACCESS                       PW2  
 MEMORY TYPE:                       Nonvolatile (SEE)

B9h	HTXP EN	LTXP EN	BIAS-HI EN	BIAS MAX EN	RESERVED	RESERVED	RESERVED	RESERVED
	bit7				bit0			

Configures the maskable interrupt for the FETG pin.

bit7	<b>HTXP EN:</b> Enables/disables active interrupts on the FETG pin due to TXP fast comparisons above the threshold limit. 0 = Disable (Default). 1 = Enable.
bit6	<b>LTXP EN:</b> Enables/disables active interrupts on the FETG pin due to TXP fast comparisons below the threshold limit. 0 = Disable (Default). 1 = Enable.
bit5	<b>BIAS HI EN:</b> Enables/disables active interrupts on the FETG pin due to BIAS fast comparisons above the threshold limit. 0 = (Default) Disable. 1 = Enable.
bit4	<b>BIAS MAX EN:</b> Enables/disables active interrupts on the FETG pin due to BIAS fast comparisons below the threshold limit. 0 = (Default) Disable. 1 = Enable.
bit3:0	<b>RESERVED</b> (Default = 0)

# PON Triplexer Control and Monitoring Circuit

**Table 02h, Register BAh: TX-F Enable<sub>1</sub> (TX-F EN<sub>1</sub>)**

FACTORY DEFAULT	00h
READ ACCESS	PW2
WRITE ACCESS	PW2
MEMORY TYPE:	Nonvolatile (SEE)

BAh	TEMP EN	V <sub>CC</sub> EN	MON1 EN	MON2 EN	MON3 EN	MON4 EN	RESERVED	RESERVED
	bit7							bit0

Configures the maskable interrupt for the TX-F pin.

bit7	<b>TEMP EN:</b> Enables/disables active interrupts on the TX-F pin due to temperature measurements outside the threshold limits. 0 = Disable (Default). 1 = Enable.
bit6	<b>V<sub>CC</sub> EN:</b> Enables/disables active interrupts on the TX-F pin due to V <sub>CC</sub> measurements outside the threshold limits. 0 = Disable (Default). 1 = Enable.
bit5	<b>MON1 EN:</b> Enables/disables active interrupts on the TX-F pin due to MON1 measurements outside the threshold limits. 0 = Disable (Default). 1 = Enable.
bit4	<b>MON2 EN:</b> Enables/disables active interrupts on the TX-F pin due to MON2 measurements outside the threshold limits. 0 = Disable (Default). 1 = Enable.
bit3	<b>MON3 EN:</b> Enables/disables active interrupts on the TX-F pin due to MON3 measurements outside the threshold limits. 0 = Disable (Default). 1 = Enable.
bit2	<b>MON4 EN:</b> Enables/disables active interrupts on the TX-F pin due to MON4 measurements outside the threshold limits. 0 = Disable (Default). 1 = Enable.
bit2:0	<b>RESERVED</b> (Default = 0)

# PON Triplexer Control and Monitoring Circuit

**Table 02h, Register BBh: TX-F Enable<sub>0</sub> (TX-F EN<sub>0</sub>)**

FACTORY DEFAULT                    00h  
 READ ACCESS                        PW2  
 WRITE ACCESS                       PW2  
 MEMORY TYPE:                       Nonvolatile (SEE)

BBh	HTXP EN	LTXP EN	BIAS-HI EN	BIAS MAX EN	RESERVED	RESERVED	RESERVED	FETG EN
	bit7				bit0			

Configures the maskable interrupt for the Tx-F pin.

bit7	<b>HTXP EN:</b> Enables/disables active interrupts on the TX-F pin due to TXP fast comparisons above the threshold limit. 0 = Disable (Default). 1 = Enable.
bit6	<b>LTXP EN:</b> Enables/disables active interrupts on the TX-F pin due to TXP fast comparisons below the threshold limit. 0 = Disable (Default). 1 = Enable.
bit5	<b>BIAS-HI EN:</b> Enables/disables active interrupts on the TX-F pin due to BIAS fast comparisons above the threshold limit. 0 = Disable (Default). 1 = Enable.
bit4	<b>BIAS MAX EN:</b> Enables/disables active interrupts on the TX-F pin due to BIAS fast comparisons above the threshold limit. 0 = Disable (Default). 1 = Enable.
bit3:1	<b>RESERVED</b> (Default = 0)
bit0	<b>FETG EN:</b> 0 = Normal FETG operation (Default). 1 = Enables FETG to act as an input to TX-F output.

# PON Triplexer Control and Monitoring Circuit

**Table 02h, Register BCh: HTXP**

FACTORY DEFAULT: 00h  
 READ ACCESS PW2  
 WRITE ACCESS PW2  
 MEMORY TYPE: Nonvolatile (SEE)

BCh	$2^7$	$2^6$	$2^5$	$2^4$	$2^3$	$2^2$	$2^1$	$2^0$
	bit7							bit0

Fast-comparison DAC threshold adjust for high transmit power. This value is added to the APC\_DAC value recalled from Table 04h. If the sum is greater than 0xFF, 0xFF is used. Comparisons greater than APC\_DAC plus this value, found on the BMD pin, will create a TXP-HI alarm.

**Table 02h, Register BDh: LTXP**

FACTORY DEFAULT: 00h  
 READ ACCESS PW2  
 WRITE ACCESS PW2  
 MEMORY TYPE: Nonvolatile (SEE)

BDh	$2^7$	$2^6$	$2^5$	$2^4$	$2^3$	$2^2$	$2^1$	$2^0$
	bit7							bit0

Fast-comparison DAC threshold adjust for low transmit power. This value is subtracted from the APC\_DAC value recalled from Table 04h. If the difference is less than 0x00, 0x00 is used. Comparisons less than APC\_DAC minus this value, found on the BMD pin, create a TXP-LO alarm.

**Table 02h, Register BEh: HBIAS**

FACTORY DEFAULT: 00h  
 READ ACCESS PW2  
 WRITE ACCESS PW2  
 MEMORY TYPE: Nonvolatile (SEE)

BEh	$2^7$	$2^6$	$2^5$	$2^4$	$2^3$	$2^2$	$2^1$	$2^0$
	bit7							bit0

Fast-comparison DAC setting for high BIAS. Comparisons greater than this value, found on the MON1 pin, create a BIAS HI alarm.

**Table 02h, Register BFh: MAX IBIAS**

FACTORY DEFAULT: 00h  
 READ ACCESS PW2  
 WRITE ACCESS PW2  
 MEMORY TYPE: Nonvolatile (SEE)

BFh	$2^{12}$	$2^{11}$	$2^{10}$	$2^9$	$2^8$	$2^7$	$2^6$	$2^5$
	bit7							bit0

This value defines the maximum DAC value allowed for the upper 8 bits of IBIAS output during all operations. During the initial step and binary search, this value will not cause an alarm but will still clamp the IBIAS DAC output. After the startup sequence (or normal APC operations), if the APC loop tries to create an IBIAS value greater than this setting, it is clamped and creates a BIAS MAX alarm. Settings 00h through FEh are intended for normal APC mode of operation. Setting FFh is reserved for manual IBIAS mode.

# PON Triplexer Control and Monitoring Circuit

**Table 02h, Register C0h: DPU**

FACTORY DEFAULT: 00h  
 READ ACCESS: PW2  
 WRITE ACCESS: PW2  
 MEMORY TYPE: Nonvolatile (SEE)

C0h	RESERVED	RESERVED	INV LOSI	MUX LOSI	D3 CNTL	D2 CNTL	D1 CNTL	D0 CNTL	
	bit7								bit0

Controls the power-on values for D3, D2, D1, and D0 output pins and mux and inversion of the LOSI pin.

Bit7:6	<b>RESERVED</b>
Bit5	<b>INV LOSI:</b> Inverts the buffered input pin LOSI to output pin D0 if MUX LOSI is set. If MUX LOSI is not set then this bit's value is a don't care. 0 = (Default) noninverted LOSI to D0 pin. 1 = Inverted LOSI to D0 pin.
Bit4	<b>MUX LOSI:</b> chooses the control for D0 output pin. 0 = (Default) D0 is controlled by bit D0 OUT found in Lower Memory, Register 78h. 1 = LOSI is buffered to D0 pin.
Bit3	<b>D3 CNTL:</b> At power-on, this value is loaded into bit D3 OUT of Lower Memory, Register 78h to control the output pin D3.
Bit2	<b>D2 CNTL:</b> At power-on, this value is loaded into bit D2 OUT of Lower Memory, Register 78h to control the output pin D2.
bit1	<b>D1 CNTL:</b> At power-on, this value is loaded into bit D1 OUT of Lower Memory, Register 78h to control the output pin D1.
bit0	<b>D0 CNTL:</b> At power-on, this value is loaded into bit D0 OUT of Lower Memory, Register 78h to control the output pin D0.

**Table 02h, Register C1h to C3h: Reserved**

FACTORY DEFAULT: 0000 0000h  
 READ ACCESS: PW2  
 WRITE ACCESS: PW2  
 MEMORY TYPE: Nonvolatile (SEE)

These registers are reserved.

**Table 02h, Register C4h: DAC1**

FACTORY DEFAULT: 00h  
 READ ACCESS: PW2  
 WRITE ACCESS: PW2  
 MEMORY TYPE: Nonvolatile (SEE)

C4h	$2^7$	$2^6$	$2^5$	$2^4$	$2^3$	$2^2$	$2^1$	$2^0$	
	bit7								bit0

Register to control DAC1.

# PON Triplexer Control and Monitoring Circuit

## Table 02h, Register C5h to C6h: Reserved

FACTORY DEFAULT:	0000 0000h
READ ACCESS	PW2
WRITE ACCESS	PW2
MEMORY TYPE:	Nonvolatile (SEE)

These registers are reserved.

## Table 02h, Register C7h: M4 LUT Cntl

FACTORY DEFAULT	00h
READ ACCESS	PW2
WRITE ACCESS	PW2
MEMORY TYPE:	Nonvolatile (SEE)

C7h	RESERVED	RESERVED	RESERVED	RESERVED	RESERVED	RESERVED	DBL_SB	UP_LOWB
	bit7							bit0

Controls the size and location of LUT functions for the MON4 measurement.

Bit7:2	<b>RESERVED:</b> Default = 000000b.
Bit1	<b>DBL_SB:</b> Chooses the size of LUT for Table 06h. 0 = (Default) Single LUT of 32 bytes. 1 = Double LUT of 16 bytes.
Bit0	<b>UP_LOWB:</b> Determines which 16-byte LUT is used if DBL_SB = 1. If DBL_SB = 0, the value of this bit is a don't care. 0 = (Default) Chooses the lower 16 bytes of Table 06h (Registers 80h-8Fh). 1 = Chooses the upper 16 bytes of Table 06h (Registers 90h-9Fh).

## Table 02h, Register C8h to F7h: No Memory

## Table 02h, Register F8h to F9h: MAN IBIAS

FACTORY DEFAULT:	00h
READ ACCESS	PW2
WRITE ACCESS	PW2 and (BIAS-EN = 0)
MEMORY TYPE:	Volatile

F8h	RESERVED	RESERVED	2 <sup>12</sup>	2 <sup>11</sup>	2 <sup>10</sup>	2 <sup>9</sup>	2 <sup>8</sup>	2 <sup>7</sup>
F9h	2 <sup>7</sup>	2 <sup>6</sup>	2 <sup>5</sup>	2 <sup>4</sup>	2 <sup>3</sup>	2 <sup>2</sup>	2 <sup>1</sup>	2 <sup>0</sup>
	bit7							bit0

When BIAS-EN (Table 02h, Register 80h) is written to 0, writes to these bytes will control the IBIAS DAC. See MAN\_CNTL (Table 02h, Register FAh) for details.

# PON Triplexer Control and Monitoring Circuit

**Table 02h, Register FAh: MAN\_CNTL**

FACTORY DEFAULT: 00h  
 READ ACCESS PW2  
 WRITE ACCESS PW2 and (Bias-En = 1)  
 MEMORY TYPE: Volatile

FAh	RESERVED	RESERVED	RESERVED	RESERVED	RESERVED	RESERVED	RESERVED	MAN_CLK
	bit7							bit0

When BIAS-EN (Table 02h, Register 80h) is written to zero, bit zero of this byte will control the updates of the MAN IBIAS value to the BIAS output. The values of MAN IBIAS should be written with a separate write command. Setting bit zero to a 1 will clock the MAN IBIAS value to the output DAC for control of IBIAS.

1. Write the MAN IBIAS value with a write command.
2. Set the MAN\_CLK bit to a 1 with a separate write command.
3. Clear the MAN\_CLK bit to a 0 with a separate write command.

**Table 02h, Register FBh to FCh: BIAS DAC**

FACTORY DEFAULT: 00 00h  
 READ ACCESS PW2  
 WRITE ACCESS N/A  
 MEMORY TYPE: Nonvolatile (SEE)

FBh	0	0	2 <sup>12</sup>	2 <sup>11</sup>	2 <sup>10</sup>	2 <sup>9</sup>	2 <sup>8</sup>	2 <sup>7</sup>
FCh	2 <sup>7</sup>	2 <sup>6</sup>	2 <sup>5</sup>	2 <sup>4</sup>	2 <sup>3</sup>	2 <sup>2</sup>	2 <sup>1</sup>	2 <sup>0</sup>
	bit7							bit0

The digital value indicating the DAC value used for IBIAS output.

**Table 02h, Register FDh to FFh: Reserved**

FACTORY DEFAULT:  
 READ ACCESS PW2  
 WRITE ACCESS N/A  
 MEMORY TYPE:

FDh	0	0	0	0	0	0	0	0
FEh	0	0	0	0	0	0	0	X
FFh	X	X	X	X	X	X	X	X
	bit7							bit0

These registers are reserved.

# PON Triplexer Control and Monitoring Circuit

## Table 03h Register Descriptions

**Table 03h, Register 80h to FFh: PW2 EEPROM**

FACTORY DEFAULT            00h  
 READ ACCESS                PW2  
 WRITE ACCESS               PW2  
 MEMORY TYPE:               Nonvolatile (EE)

80h-FFh	EE	EE	EE	EE	EE	EE	EE	EE
	bit7							bit0

PW2 protected EEPROM.

## Table 04h Register Descriptions

**Table 04h, Register 80h to C7h: MOD LUT**

FACTORY DEFAULT            00h  
 READ ACCESS                PW2  
 WRITE ACCESS               PW2  
 MEMORY TYPE:               Nonvolatile (EE)

80h-C7h	2 <sup>7</sup>	2 <sup>6</sup>	2 <sup>5</sup>	2 <sup>4</sup>	2 <sup>3</sup>	2 <sup>2</sup>	2 <sup>1</sup>	2 <sup>0</sup>
	bit7							bit0

The digital value for the modulation DAC output.

The Modulation LUT is a set of registers assigned to hold the temperature profile for the modulation DAC. The values in this table combined with the MOD bits in the MOD Ranging register (Table 02h, Register 8Bh) determine the set point for the modulation voltage. The temperature measurement is used to index the LUT (T INDEX, Table 02h, Register 81h) in 2°C increments from -40°C to +102°C, starting at 80h in Table 04h. Register 80h defines the -40°C to -38°C MOD output, register 81h defines -38°C to -36°C MOD output, and so on. Values recalled from this EEPROM memory table are written into the MOD\_DAC (Table 02h, Register 82h) location that holds the value until the next temperature conversion. The part can be placed into a manual mode (MOD-EN bit, Table 02h, Register 80h), where MOD\_DAC is directly controlled for calibration. If the temperature compensation functionality is not required, then program the entire Table 04h to the desired modulation setting.



# PON Triplexer Control and Monitoring Circuit

**Table 05h Register Descriptions**

**Table 05h, Register 80h to A3h: APC Tracking Error LUT (APC REF)**

FACTORY DEFAULT: 00h  
 READ ACCESS: PW2  
 WRITE ACCESS: PW2  
 MEMORY TYPE: Nonvolatile (EE)

80h-A3h	$2^7$	$2^6$	$2^5$	$2^4$	$2^3$	$2^2$	$2^1$	$2^0$
	bit7							bit0

The Tracking Error LUT is set of registers assigned to hold the temperature profile for the APC reference DAC. The values in this table combined with the APC bits in the Comp Ranging register (Table 02h, Register 8Dh) determine the set point for the APC loop. The temperature measurement is used to index the LUT (T INDEX, Table 02h, Register 81h) in 4°C increments from -40°C to +100°C, starting at register 80h in Table 05h. Register 80h defines the -40°C to -36°C APC reference value, register 81h defines -36°C to -32°C APC reference value, and so on. Values recalled from this EEPROM memory table are written into the APC DAC (Table 02h, Register 83h) location that holds the value until the next temperature conversion. The part can be placed into a manual mode (APC-EN bit, Table 02h, Register 80h), where APC DAC can be directly controlled for calibration. If tracking error temperature compensation is not required by the application, program the entire LUT to the desired APC set point.

**Table 05h, Register A4h to A7h: Reserved**

FACTORY DEFAULT: 00h  
 READ ACCESS: PW2  
 WRITE ACCESS: PW2  
 MEMORY TYPE: Nonvolatile (SEE)

These registers are reserved.

# PON Triplexer Control and Monitoring Circuit

## Table 06h Register Descriptions

**Table 06h, Register 80h to 9Fh: M4DAC LUT**

FACTORY DEFAULT	00h
READ ACCESS	PW2
WRITE ACCESS	PW2
MEMORY TYPE:	Nonvolatile (EE)

80h-9Fh	$2^7$	$2^6$	$2^5$	$2^4$	$2^3$	$2^2$	$2^1$	$2^0$
	bit7							bit0

The M4DAC LUT is set of registers assigned to hold the voltage profile for the M4DAC. The values in this table determine the set point for the M4DAC. The MON4 voltage measurement is used to index the LUT (Vindex, Table 02h, Register 84h), starting at register 80h in Table 06h. Values recalled from this EEPROM memory table are written into the M4DAC (Table 02h, Register 85h) location that holds the value until the next MON4 voltage conversion. The part can be placed into a manual mode (M4DAC-EN bit, Table 02h, Register 80h), where M4DAC is directly controlled for calibration. If voltage compensation is not required by the application, program the entire LUT to the desired M4DAC set point.

## Auxiliary Memory A0h Register Descriptions

**Auxiliary Memory A0h, Register 00h to 7fh: EEPROM**

FACTORY DEFAULT	00h
READ ACCESS	PW2
WRITE ACCESS	PW2
MEMORY TYPE:	Nonvolatile (EE)

00h-7Fh	EE	EE	EE	EE	EE	EE	EE	EE
	bit7							bit0

EEPROM

## Package Information

For the latest package outline information and land patterns, go to [www.maxim-ic.com/packages](http://www.maxim-ic.com/packages). Note that a "+", "#", or "-" in the package code indicates RoHS status only. Package drawings may show a different suffix character, but the drawing pertains to the package regardless of RoHS status.

PACKAGE TYPE	PACKAGE CODE	DOCUMENT NO.
28 TQFN-EP	T2855+8	<a href="#">21-0140</a>

# PON Triplexer Control and Monitoring Circuit

## Revision History

REVISION NUMBER	REVISION DATE	DESCRIPTION	PAGES CHANGED
0	3/07	Initial release	—
1	11/09	Changed the high voltage parameter from +5.5V to +3.9V	1-6

DS1865

Maxim cannot assume responsibility for use of any circuitry other than circuitry entirely embodied in a Maxim product. No circuit patent licenses are implied. Maxim reserves the right to change the circuitry and specifications without notice at any time.

Maxim Integrated Products, 120 San Gabriel Drive, Sunnyvale, CA 94086 408-737-7600 \_\_\_\_\_ 67

© 2009 Maxim Integrated Products

Maxim is a registered trademark of Maxim Integrated Products, Inc.

 DALLAS SEMICONDUCTOR is a registered trademark of Dallas Semiconductor Corporation.