

HI-5040 thru HI-5051 HI-5046A and HI-5047A

December 1993

CMOS Analog Switches

Features

- $\pm 15\text{V}$ Wide Analog Signal Range
- Low "ON" Resistance 25Ω (Typical)
- High Current Capability 80mA (Typical)
- Break-Before-Make Switching
 - Turn-On Time 370ns (Typical)
 - Turn-Off Time 280ns (Typical)
- No Latch-Up
- Input MOS Gates are Protected from Electrostatic Discharge
- DTL, TTL, CMOS, PMOS Compatible

Applications

- High Frequency Switching
- Sample and Hold
- Digital Filters
- Operational Amplifier Gain Switching

Description

This family of CMOS analog switches offers low resistance switching performance for analog voltages up to the supply rails and for signal currents up to 80mA . "ON" resistance is low and stays reasonably constant over the full range of operating signal voltage and current. R_{ON} remains exceptionally constant for input voltages between $+5\text{V}$ and -5V and currents up to 50mA . Switch impedance also changes very little over temperature, particularly between 0°C and $+75^\circ\text{C}$. R_{ON} is nominally 25Ω for HI-5048 through HI-5051 and HI-5046A and HI-5047A and 50Ω for HI-5040 through HI-5047.

All devices provide break-before-make switching and are TTL and CMOS compatible for maximum application versatility. Performance is further enhanced by Dielectric Isolation processing which insures latch-free operation with very low input and output leakage currents (0.8nA at $+25^\circ\text{C}$). This family of switches also features very low power operation (1.5mW at $+25^\circ\text{C}$).

There are 14 devices in this switch series which are differentiated by type of switch action and value of R_{ON} (see Functional Description). All devices are available in 16 lead DIP packages. The HI-5040 and HI-5050 switches can directly replace IH-5040 series devices except IH5048, and are functionally compatible with the DG180 and DG190 family. Each switch type is available in the -55°C to $+125^\circ\text{C}$ and 0°C to $+75^\circ\text{C}$ performance grades.

Functional Description

PART NUMBER	TYPE	R_{ON}
HI-5040	SPST	50Ω
HI-5041	Dual SPST	50Ω
HI-5042	SPDT	50Ω
HI-5043	Dual SPDT	50Ω
HI-5044	DPST	50Ω
HI-5045	Dual DPST	50Ω
HI-5046	DPDT	50Ω
HI-5046A	DPDT	25Ω
HI-5047	4PST	50Ω
HI-5047A	4PST	25Ω
HI-5048	Dual SPST	25Ω
HI-5049	Dual DPST	25Ω
HI-5050	SPDT	25Ω
HI-5051	Dual SPDT	25Ω

Functional Block Diagram

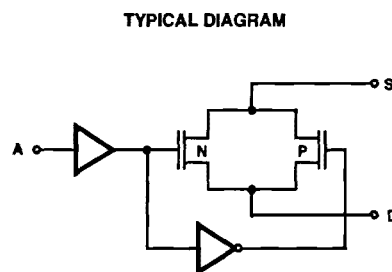

HI-5040 Series

Ordering Information

PART NUMBER	TEMPERATURE RANGE	PACKAGE
HI1-5040-7	0°C to +75°C + 96 Hr. Burn-In	16 Lead Ceramic DIP
HI3-5040-5	0°C to +75°C	16 Lead Plastic DIP
HI1-5040-2	-55°C to +125°C	16 Lead Ceramic DIP
HI1-5040-5	0°C to +75°C	16 Lead Ceramic DIP
HI3-5041-5	0°C to +75°C	16 Lead Plastic DIP
HI1-5041-5	0°C to +75°C	16 Lead Ceramic DIP
HI1-5041-2	-55°C to +125°C	16 Lead Ceramic DIP
HI1-5041-7	0°C to +75°C + 96 Hr. Burn-In	16 Lead Ceramic DIP
HI3-5042-5	0°C to +75°C	16 Lead Plastic DIP
HI1-5042-5	0°C to +75°C	16 Lead Ceramic DIP
HI1-5042-7	0°C to +75°C + 96 Hr. Burn-In	16 Lead Ceramic DIP
HI1-5042-2	-55°C to +125°C	16 Lead Ceramic DIP
HI1-5043-7	0°C to +75°C + 96 Hr. Burn-In	16 Lead Ceramic DIP
HI1-5043-2	-55°C to +125°C	16 Lead Ceramic DIP
HI3-5043-5	0°C to +75°C	16 Lead Plastic DIP
HI1-5043-5	0°C to +75°C	16 Lead Ceramic DIP
HI1-5044-7	0°C to +75°C + 96 Hr. Burn-In	16 Lead Ceramic DIP
HI1-5044-5	0°C to +75°C	16 Lead Ceramic DIP
HI3-5044-5	0°C to +75°C	16 Lead Plastic DIP
HI1-5044-2	-55°C to +125°C	16 Lead Ceramic DIP
HI1-5045-5	0°C to +75°C	16 Lead Ceramic DIP
HI1-5045-7	0°C to +75°C + 96 Hr. Burn-In	16 Lead Ceramic DIP
HI1-5045-2	-55°C to +125°C	16 Lead Ceramic DIP
HI3-5045-5	0°C to +75°C	16 Lead Plastic DIP
HI1-5046-2	-55°C to +125°C	16 Lead Ceramic DIP
HI1-5046-5	0°C to +75°C	16 Lead Ceramic DIP
HI1-5046-7	0°C to +75°C + 96 Hr. Burn-In	16 Lead Ceramic DIP
HI3-5046-5	0°C to +75°C	16 Lead Plastic DIP
HI1-5046A-7	0°C to +75°C + 96 Hr. Burn-In	16 Lead Ceramic DIP
HI3-5046A-5	0°C to +75°C	16 Lead Plastic DIP
HI1-5046A-2	-55°C to +125°C	16 Lead Ceramic DIP
HI1-5046A-5	0°C to +75°C	16 Lead Ceramic DIP
HI1-5047-5	0°C to +75°C	16 Lead Ceramic DIP
HI1-5047-7	0°C to +75°C + 96 Hr. Burn-In	16 Lead Ceramic DIP
HI1-5047-2	-55°C to +125°C	16 Lead Ceramic DIP
HI3-5047-5	0°C to +75°C	16 Lead Plastic DIP
HI1-5047A-5	0°C to +75°C	16 Lead Ceramic DIP
HI1-5047A-2	-55°C to +125°C	16 Lead Ceramic DIP
HI3-5047A-5	0°C to +75°C	16 Lead Plastic DIP
HI1-5047A-7	0°C to +75°C + 96 Hr. Burn-In	16 Lead Ceramic DIP

PART NUMBER	TEMPERATURE RANGE	PACKAGE
HI1-5048-5	0°C to +75°C	16 Lead Ceramic DIP
HI1-5048-7	0°C to +75°C + 96 Hr. Burn-In	16 Lead Ceramic DIP
HI3-5048-5	0°C to +75°C	16 Lead Plastic DIP
HI1-5048-2	-55°C to +125°C	16 Lead Ceramic DIP
HI1-5049-5	0°C to +75°C	16 Lead Ceramic DIP
HI1-5049-2	-55°C to +125°C	16 Lead Ceramic DIP
HI3-5049-5	0°C to +75°C	16 Lead Plastic DIP
HI1-5049-7	0°C to +75°C + 96 Hr. Burn-In	16 Lead Ceramic DIP
HI1-5050-5	0°C to +75°C	16 Lead Ceramic DIP
HI1-5050-2	-55°C to +125°C	16 Lead Ceramic DIP
HI3-5050-5	0°C to +75°C	16 Lead Plastic DIP
HI1-5050-7	0°C to +75°C + 96 Hr. Burn-In	16 Lead Ceramic DIP
HI1-5051-5	0°C to +75°C	16 Lead Ceramic DIP
HI1-5051-2	-55°C to +125°C	16 Lead Ceramic DIP
HI1-5051-7	0°C to +75°C + 96 Hr. Burn-In	16 Lead Ceramic DIP
HI4P5051-5	0°C to +75°C	20 Lead PLCC
HI3-5051-5	0°C to +75°C	16 Lead Plastic DIP
HI1-5040/883	-55°C to +125°C	16 Lead Ceramic DIP
HI1-5041/883	-55°C to +125°C	16 Lead Ceramic DIP
HI1-5042/883	-55°C to +125°C	16 Lead Ceramic DIP
HI1-5043/883	-55°C to +125°C	16 Lead Ceramic DIP
HI1-5044/883	-55°C to +125°C	16 Lead Ceramic DIP
HI1-5045/883	-55°C to +125°C	16 Lead Ceramic DIP
HI1-5046/883	-55°C to +125°C	16 Lead Ceramic DIP
HI1-5046A/883	-55°C to +125°C	16 Lead Ceramic DIP
HI1-5047/883	-55°C to +125°C	16 Lead Ceramic DIP
HI1-5047A/883	-55°C to +125°C	16 Lead Ceramic DIP
HI1-5048/883	-55°C to +125°C	16 Lead Ceramic DIP
HI1-5049/883	-55°C to +125°C	16 Lead Ceramic DIP
HI1-5050/883	-55°C to +125°C	16 Lead Ceramic DIP
HI1-5051/883	-55°C to +125°C	16 Lead Ceramic DIP
HI4-5043/883	-55°C to +125°C	20 Lead CLCC
HI4-5045/883	-55°C to +125°C	16 Lead Ceramic DIP
HI4-5051/883	-55°C to +125°C	16 Lead Ceramic DIP
HI9P5043-5	0°C to +75°C	16 SOIC (N)
HI9P5045-5	0°C to +75°C	16 SOIC (N)
HI9P5049-5	0°C to +75°C	16 SOIC (N)
HI9P5051-5	0°C to +75°C	16 SOIC (N)
HI9P5043-9	-40°C to +85°C	16 SOIC (N)
HI9P5045-9	-40°C to +85°C	16 SOIC (N)
HI9P5049-9	-40°C to +85°C	16 SOIC (N)
HI9P5051-9	-40°C to +85°C	16 SOIC (N)

HI-5040 Series

Pin Configurations

Switch States are Logic "0" Input

SINGLE CONTROL

SPST
HI-5040 (50Ω)

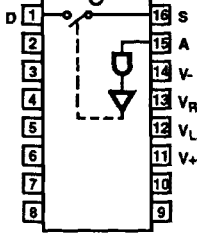

SPDT
HI-5042 (50Ω), HI-5050 (25Ω)

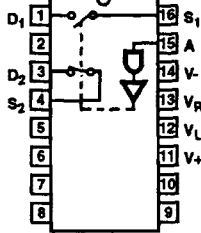

DPST
HI-5044 (50Ω)

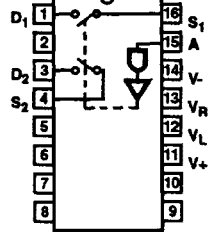

DPDT
HI-5046 (50Ω), HI-5046A (25Ω)

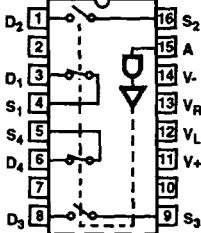

4PST
HI-5047 (50Ω), HI-5047A (25Ω)

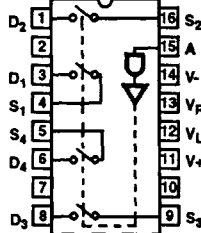

DUAL CONTROL

DUAL SPST
HI-5041 (50Ω)

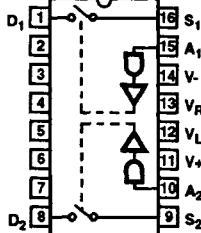

DUAL SPDT
HI-5043 (50Ω), HI-5051 (25Ω)

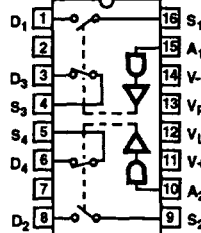

DUAL DPST
HI-5045 (50Ω), HI-5049 (25Ω)

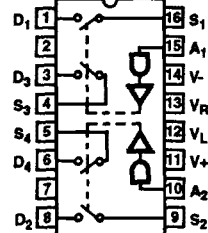

DUAL SPST
HI-5048 (25Ω)

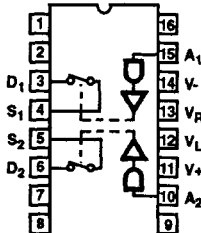

DUAL SPDT
HI-5043 (50Ω), HI-5051 (25Ω)

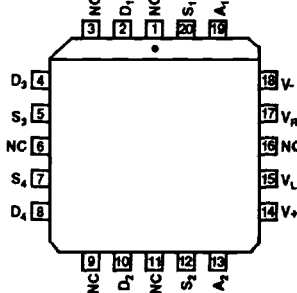

NOTE: Unused pins may be internally connected. Ground all unused pins.

HI-5040 Series

Switch Functions Switch States are Logic "1" Input

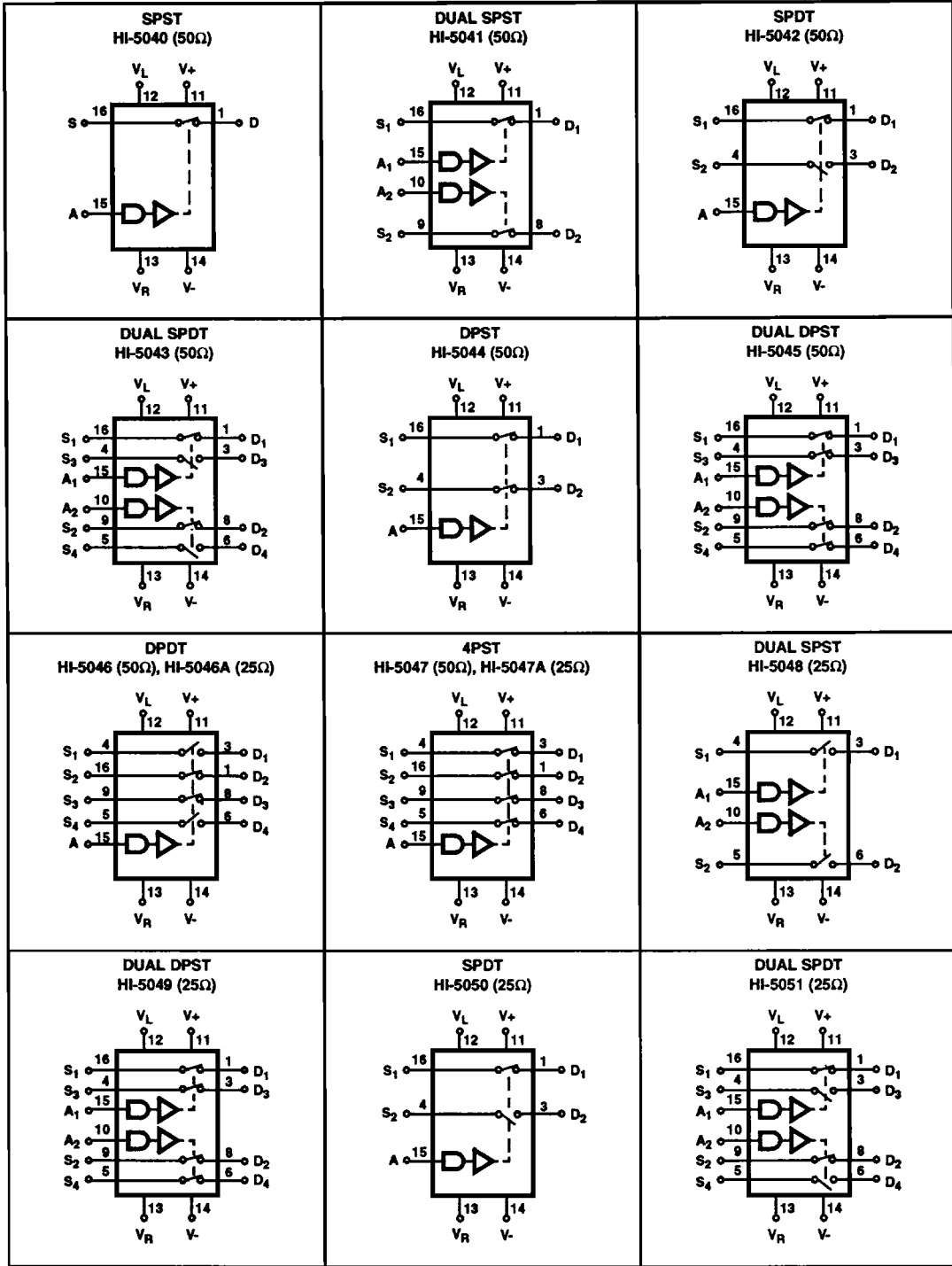

Specifications HI-5040 Series

Absolute Maximum Ratings

Supply Voltage (V+, V-)	36V
V _R to Ground	V+, V-
Digital and Analog Input Voltage	+V _{SUPPLY} +4V, -V _{SUPPLY} -4V
Analog Current (S to D) Continuous	30mA
Analog Current (S to D) Peak	80mA
Storage Temperature	-65°C to +150°C
Lead Temperature (Soldering 10s)	+300°C

Thermal Information

Thermal Resistance	θ_{JA}	θ_{JC}
Ceramic DIP Package	80°C/W	24°C/W
SOIC Package	120°C/W	-
Plastic DIP Package	100°C/W	-
PLCC Package	80°C/W	-
CLCC Package	75°C/W	20°C/W
Junction Temperature		
Plastic Packages	+150°C	
Ceramic Packages	+175°C	
Operating Temperature Range		
HI-50XX-2	-55°C to +125°C	
HI-50XX-5, -7	0°C to +75°C	
HI-50XX-9	-40°C to +85°C	

CAUTION: Stresses above those listed in "Absolute Maximum Ratings" may cause permanent damage to the device. This is a stress only rating and operation of the device at these or any other conditions above those indicated in the operational sections of this specification is not implied.

Electrical Specifications

Supplies = +15V, -15V; V_R = 0V; V_{AH} (Logic Level High) = 2.4V, V_{AL} (Logic Level Low) = +0.8V, V_L = +5V, Unless Otherwise Specified. For Test Conditions, Consult Performance Characteristics, Unused Pins are Grounded.

PARAMETER	TEST CONDITIONS	TEMP	-55°C To +125°C			0°C To +75°C			UNITS
			MIN	TYP	MAX	MIN	TYP	MAX	
SWITCHING CHARACTERISTICS									
t _{ON} , Switch On Time	(Note 4)	+25°C	-	370	500	-	370	500	ns
t _{OFF} , Switch Off Time	(Note 4)	+25°C	-	280	500	-	280	500	ns
Charge Injection	(Note 2)	+25°C	-	5	20	-	5	-	mV
"Off Isolation"	(Note 3)	+25°C	75	80	-	-	80	-	dB
"Crosstalk"	(Note 3)	+25°C	80	88	-	-	88	-	dB
C _{S(OFF)} , Input Switch Capacitance		+25°C	-	11	-	-	11	-	pF
C _{D(OFF)} , Output Switch Capacitance		+25°C	-	11	-	-	11	-	pF
C _{D(ON)} , Output Switch Capacitance		+25°C	-	22	-	-	22	-	pF
C _A , Digital Input Capacitance		+25°C	-	5	-	-	5	-	pF
C _{DS(OFF)} , Drain-To-Source Capacitance		+25°C	-	0.5	-	-	0.5	-	pF
DIGITAL INPUT CHARACTERISTICS									
V _{AL} , Input Low Threshold		Full	-	-	0.8	-	-	0.8	V
V _{AH} , Input High Threshold		Full	2.4	-	-	2.4	-	-	V
I _A , Input Leakage Current (High or Low)		Full	-	0.01	1.0	-	0.01	1.0	μA
ANALOG SWITCH CHARACTERISTICS									
Analog Signal Range		Full	-15	-	+15	-15	-	+15	V
R _{ON} , On Resistance	(Note 1A)	+25°C	-	50	75	-	50	75	Ω
R _{ON} , On Resistance		Full	-	-	150	-	-	150	Ω
	(Note 1B)	+25°C	-	25	45	-	25	45	Ω
R _{ON} , Channel-to-Channel Match	(Note 1A)	+25°C	-	2	10	-	2	10	Ω
R _{ON} , Channel-to-Channel Match	(Note 1B)	+25°C	-	1	5	-	1	5	Ω
I _{S(OFF)} = I _{D(OFF)} , Off Input or Output Leakage Current		+25°C	-	0.8	2	-	0.8	2	nA
		Full	-	100	200	-	100	200	nA

Specifications HI-5040 Series

Electrical Specifications

Supplies = +15V, -15V; $V_R = 0V$; V_{AH} (Logic Level High) = 2.4V, V_{AL} (Logic Level Low) = +0.8V, $V_L = +5V$, Unless Otherwise Specified. For Test Conditions, Consult Performance Characteristics, Unused Pins are Grounded. (Continued)

PARAMETER	TEST CONDITIONS	TEMP	-55°C To +125°C			0°C To +75°C			UNITS
			MIN	TYP	MAX	MIN	TYP	MAX	
$I_{D(ON)}$, On Leakage Current		+25°C	-	0.01	2	-	0.01	2	nA
		Full	-	2	200	-	2	200	nA
POWER REQUIREMENTS									
P_D , Quiescent Power Dissipation		+25°C	-	1.5	-	-	1.5	-	mW
I_+ , I_- , I_L , I_R		+25°C	-	-	0.2	-	-	0.3	mA
I_+ , +15V Quiescent Current	(Note 4)	Full	-	-	0.3	-	-	0.5	mA
I_- , -15V Quiescent Current	(Note 4)	Full	-	-	0.3	-	-	0.5	mA
I_L , +5V Quiescent Current	(Note 4)	Full	-	-	0.3	-	-	0.5	mA
I_R , Ground Quiescent Current	(Note 4)	Full	-	-	0.3	-	-	0.5	mA

NOTES:

1. $V_{OUT} = \pm 10V$, $I_{OUT} = \mp 1mA$
 A). For HI-5040 thru HI-5047
 B). For HI-5048 thru HI-5051, HI-5046A/5047A.
2. $V_{IN} = 0V$, $C_L = 10,000pF$.
3. $R_L = 100\Omega$, $f = 100kHz$, $V_{IN} = 2.0V_{P-P}$, $C_L = 5pF$.
4. $V_{AL} = 0V$, $V_{AH} = 5V$.

Switching Waveforms

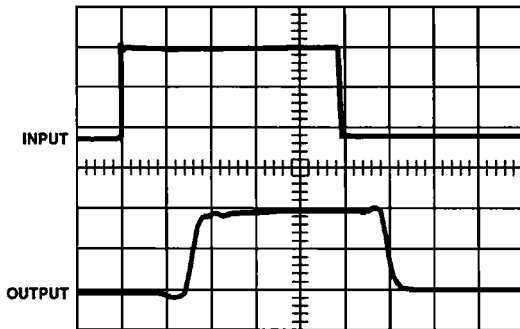

Top: TTL Input (1V/Div.)
 $V_{AH} = 5V$, $V_{AL} = 0V$
 Bottom: Output (2V/Div.)
 Horizontal: 200ns/Div.

FIGURE 1.

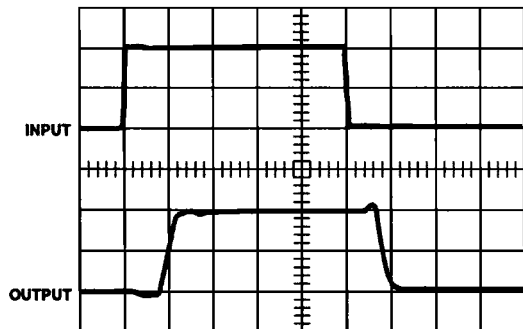

Top: CMOS Input (5V/Div.)
 $V_{AH} = 10V$, $V_{AL} = 0V$
 Bottom: Output (5V/Div.)
 Horizontal: 200ns/Div.

FIGURE 2.

HI-5040 Series

Typical Performance Curves and Test Circuits

$T_A = +25^\circ\text{C}$, $V_+ = +15\text{V}$, $V_- = -15\text{V}$, $V_L = +5\text{V}$, $V_R = 0\text{V}$, $V_{AH} = 3.0\text{V}$ and $V_{AL} = 0.8\text{V}$, Unless Otherwise Specified

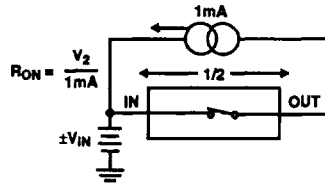

FIGURE 3. "ON" RESISTANCE vs ANALOG SIGNAL LEVEL, SUPPLY VOLTAGE AND TEMPERATURE

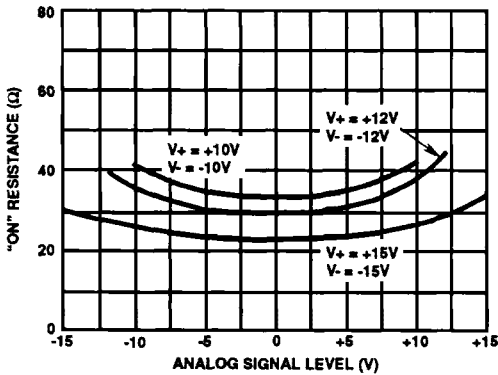

FIGURE 4. "ON" RESISTANCE vs ANALOG SIGNAL LEVEL AND POWER SUPPLY VOLTAGE

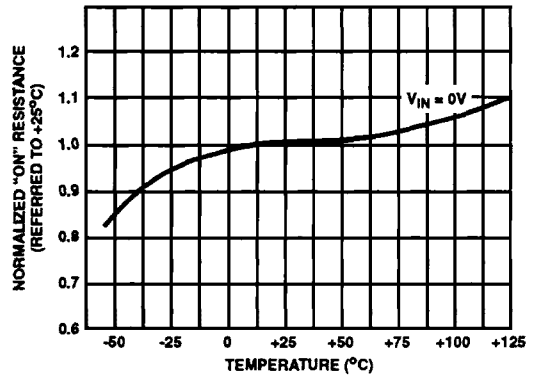

FIGURE 5. NORMALIZED "ON" RESISTANCE vs TEMPERATURE

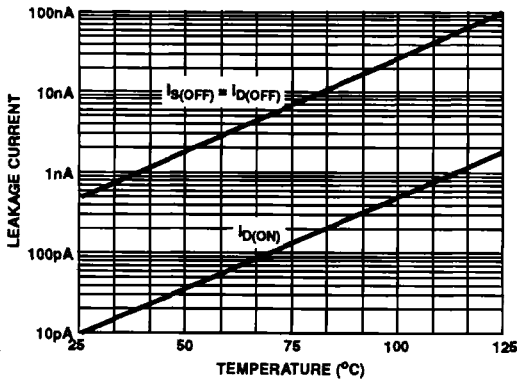
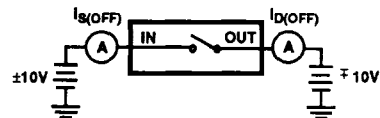
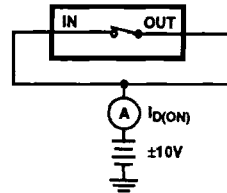

FIGURE 6. ON/OFF LEAKAGE CURRENT vs TEMPERATURE

OFF LEAKAGE CURRENT vs TEMPERATURE



ON LEAKAGE CURRENT vs TEMPERATURE



Typical Performance Curves and Test Circuits

$T_A = +25^\circ\text{C}$, $V_+ = +15\text{V}$, $V_- = -15\text{V}$, $V_L = +5\text{V}$, $V_R = 0\text{V}$, $V_{AH} = 3.0\text{V}$ and $V_{AL} = 0.8\text{V}$, Unless Otherwise Specified (Continued)

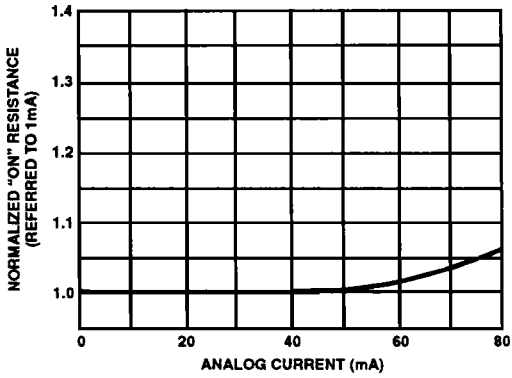

FIGURE 7. NORMALIZED "ON" RESISTANCE vs ANALOG CURRENT

"ON" RESISTANCE vs ANALOG CURRENT

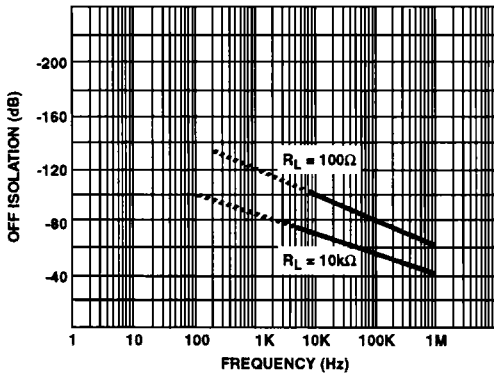
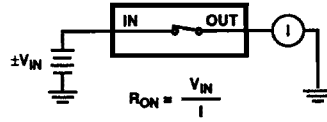

FIGURE 8. "OFF" ISOLATION vs FREQUENCY

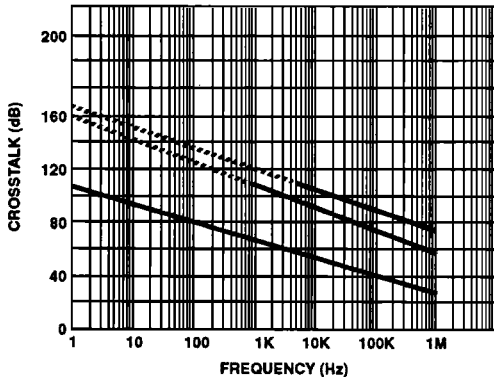
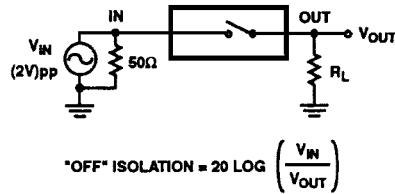
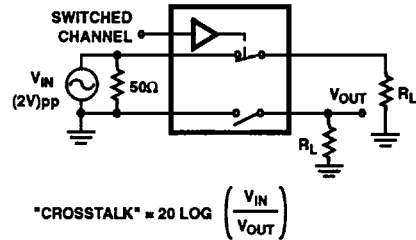

FIGURE 9. CROSSTALK vs FREQUENCY



HI-5040 Series

Typical Performance Curves and Test Circuits

$T_A = +25^\circ\text{C}$, $V_+ = +15\text{V}$, $V_- = -15\text{V}$, $V_L = +5\text{V}$, $V_R = 0\text{V}$, $V_{AH} = 3.0\text{V}$ and $V_{AL} = 0.8\text{V}$, Unless Otherwise Specified (Continued)

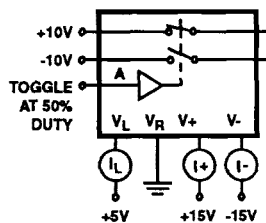
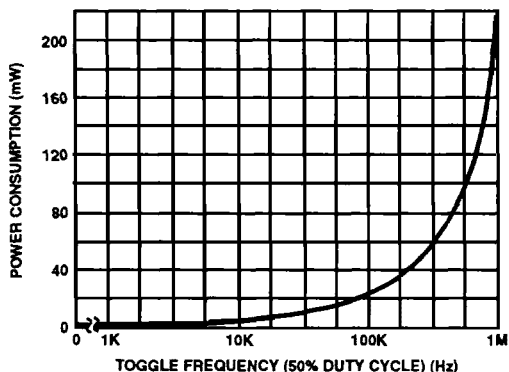

FIGURE 10. POWER CONSUMPTION vs FREQUENCY

Switching Characteristics

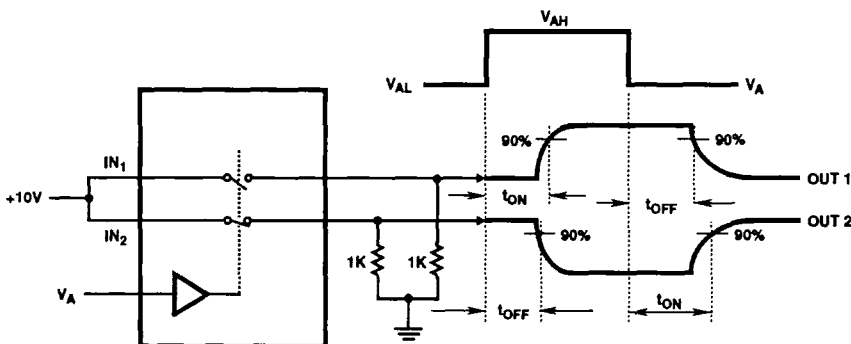

FIGURE 11. ON/OFF SWITCH TIME vs LOGIC LEVEL

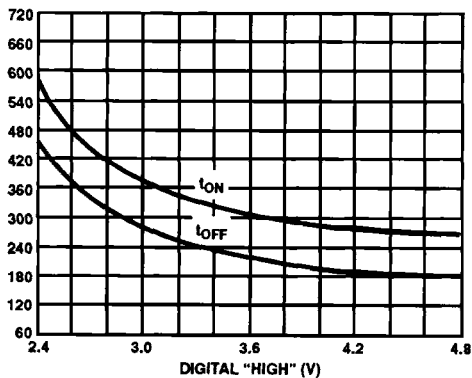

FIGURE 12. SWITCHING TIMES FOR POSITIVE DIGITAL TRANSITION

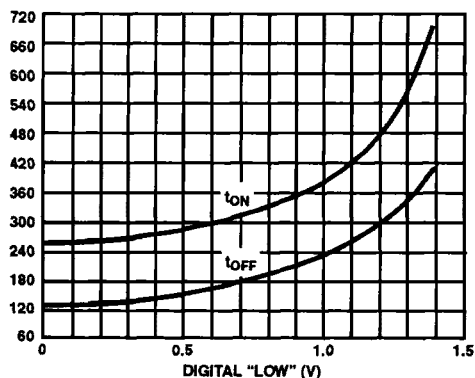

FIGURE 13. SWITCHING TIMES FOR NEGATIVE DIGITAL TRANSITION

Switching Characteristics (Continued)

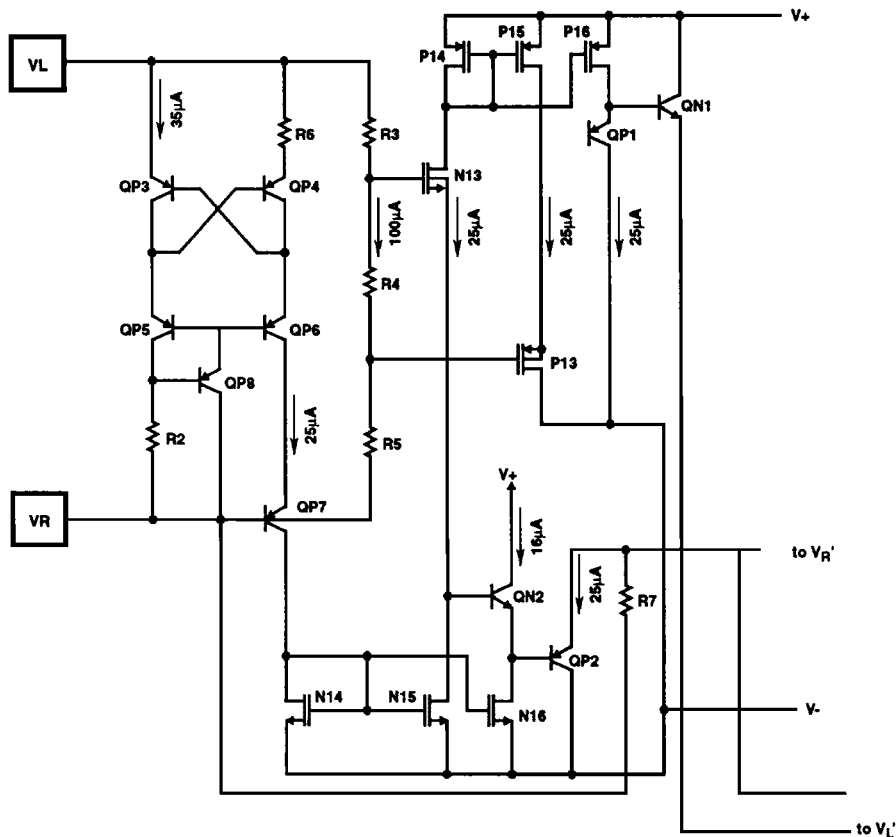

FIGURE 14. TTL/CMOS REFERENCE CIRCUIT (Note 1)

NOTE:

1. Connect V_+ to V_L for minimizing power consumption when driving from CMOS circuits.

Switching Characteristics (Continued)

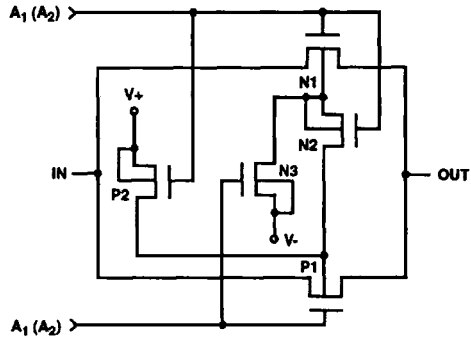
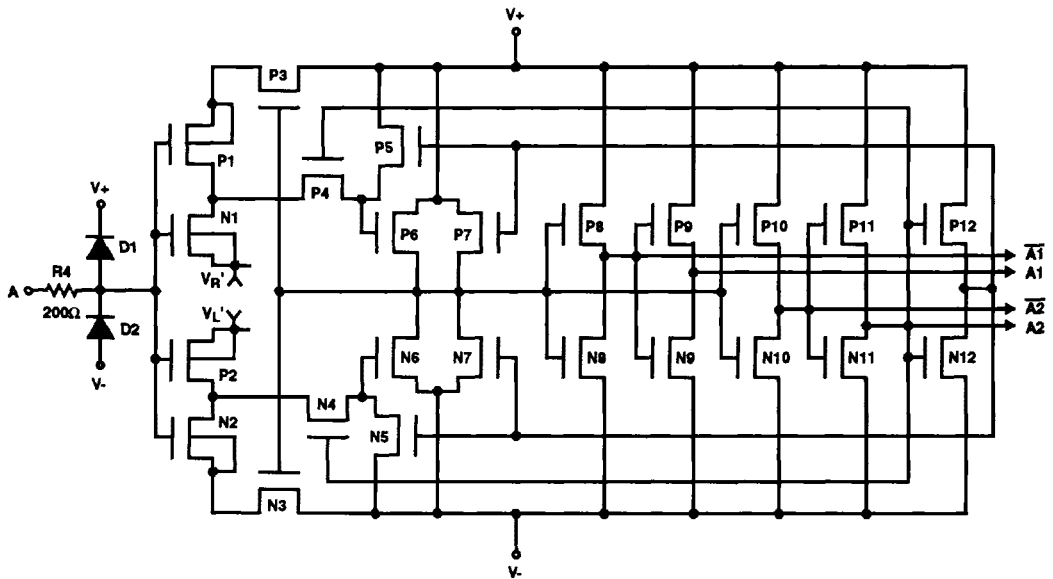

FIGURE 15. SWITCH CELL



NOTES:

1. All n-channel bodies to V-, all p-channel bodies to V+ except as shown.
2. For further information refer to Application Notes 520, 521, 531, 532 and 557.

FIGURE 16. DIGITAL INPUT BUFFER AND LEVEL SHIFTER