



### Main

Range of Product	Phaseo
Product or Component Type	Redundancy module
Input voltage	24...28.8 V DC
Output voltage	(U <sub>in</sub> -0.2) V DC
Maximum output current	40 A

### Complementary

Input voltage limits	22...30 V
Input current	20 A
Number of output channels	1
Output protection type	Against overload external protection by power supply Against short-circuits external protection by power supply
Connections - terminals	Output connection screw type terminals 2 x 0.5...2 x 10 mm <sup>2</sup> AWG 20...AWG 8 Input connection screw type terminals 4 x 0.5...4 x 10 mm <sup>2</sup> AWG 20...AWG 8 Diagnostic relay removable screw terminal block 1 x 2.5 mm <sup>2</sup> AWG 14
Fixing mode	By clips 35 mm symmetrical DIN rail horizontal By clips 35 mm symmetrical DIN rail vertical
Output coupling	Parallel
Operating altitude	6561.68 ft (2000 m)
Marking	CE
Name of test	Electrostatic discharges EN/IEC 61000-4-2 Emission EN 61000-6-3 Induced electromagnetic field EN/IEC 61000-4-6 level 3 Radiated electromagnetic field EN/IEC 61000-4-3 level 3 Rapid transient IEC 61000-4-4 level 3 Surge EN/IEC 61000-4-5 level 2 Conducted/Radiated emissions EN 55022 Class B Emission EN 50081-1
Local signalling	For power supply status 1 LED per input (green) For power supply status 1 relay
Net Weight	1.54 lb(US) (0.7 kg)

### Environment

Product Certifications	EAC RCM
Standards	CSA C22.2 No 60950-1 UL 508
Ambient air temperature for operation	-13...140 °F (-25...60 °C)
Ambient Air Temperature for Storage	-40...185 °F (-40...85 °C)
Environmental characteristic	EMC EN 61000-6-3 EMC EN/IEC 61000-6-2 Safety EN/IEC 60950-1 Safety EN/IEC 61204
IP degree of protection	IP20 conforming to EN/IEC 60529
Dielectric strength	500 V between input and ground 500 V between output and ground
Overvoltage category	Class II VDE 0106-1

Relative Humidity	0...90 % during operation 0...95 % during storage
MTBF reliability	24 V with UTE C80-810
Vibration resistance	2 gn 11.9...150 Hz)EN/IEC 61131-2 3.5 mm 3...11.9 Hz)EN/IEC 61131-2

## Ordering and shipping details

Category	22525 - ABL8 AND ABL7 POWER SUPPLIE
Discount Schedule	CP12
GTIN	3389119406871
Nbr. of units in pkg.	1
Package weight(Lbs)	20.95 oz (594 g)
Returnability	Yes
Country of origin	PH

## Packing Units

Unit Type of Package 1	PCE
Package 1 Height	2.56 in (6.5 cm)
Package 1 width	6.50 in (16.5 cm)
Package 1 Length	6.30 in (16 cm)
Unit Type of Package 2	S03
Number of Units in Package 2	10
Package 2 Weight	13.10 lb(US) (5.94 kg)
Package 2 Height	11.81 in (30 cm)
Package 2 width	11.81 in (30 cm)
Package 2 Length	15.75 in (40 cm)
Unit Type of Package 3	PAL
Number of Units in Package 3	80
Package 3 Weight	136.08 lb(US) (61.724 kg)
Package 3 Height	30.31 in (77 cm)
Package 3 width	23.62 in (60 cm)
Package 3 Length	31.50 in (80 cm)

## Offer Sustainability

California proposition 65	WARNING: This product can expose you to chemicals including: Lead and lead compounds, which is known to the State of California to cause cancer and birth defects or other reproductive harm. For more information go to <a href="http://www.P65Warnings.ca.gov">www.P65Warnings.ca.gov</a>
REACH Regulation	 <a href="#">REACH Declaration</a>
REACH free of SVHC	Yes
EU RoHS Directive	Pro-active compliance (Product out of EU RoHS legal scope)  <a href="#">EU RoHS Declaration</a>
Mercury free	Yes
RoHS exemption information	 <a href="#">Yes</a>
China RoHS Regulation	 <a href="#">China RoHS Declaration</a>
PVC free	Yes

## Contractual warranty

Warranty	18 months
----------	-----------

Redundancy Module

Dimensions

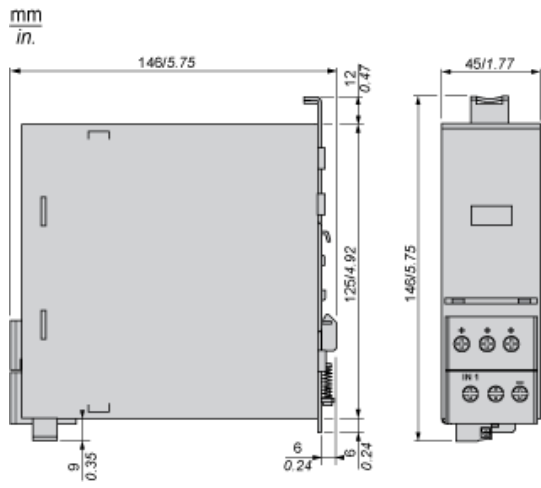

---

Redundancy Module

---

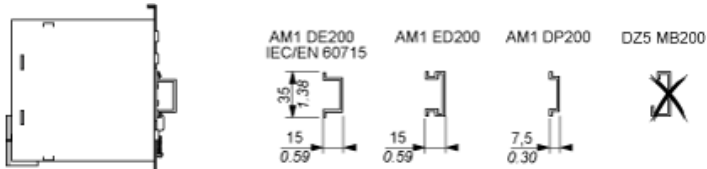

Mounting

Redundancy modules can be installed on a DIN rail. The graphic below provides the characteristics and references of the compatible DIN rails for the mounting of the module.

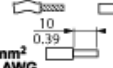

Wiring Requirements

Cable Types and Wire Sizes

mm /in			ABL	8RPS24030	8RPS24050 8RPS24100	8RPM24200 8WPS24200/24400
$\varnothing \leq 4 \text{ mm}^2$ $\varnothing \leq 12 \text{ AWG}$	$\varnothing > 4 \text{ mm}^2$ $\varnothing > 12 \text{ AWG}$					
+ In -	mm <sup>2</sup> /AWG			1...4 / 16...12		
+ Out -	mm <sup>2</sup> /AWG			1...4 / 16...12	4...10 / 12...6	
	mm/in			4 / 0.16		
11...14	mm <sup>2</sup> /AWG			-	0,2...2,5 / 24...14	

Internal Wiring Diagram

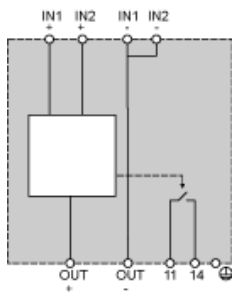

Scheme of Use with Power Supplies

Wiring Diagram with  $I_n \leq 20\text{mA}$

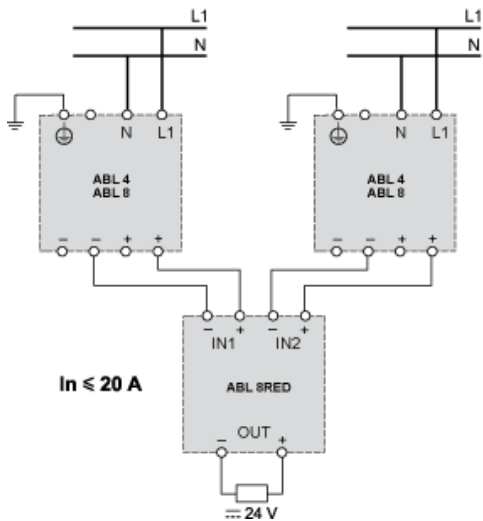

## Wiring Diagram with $I_n \leq 40\text{mA}$

