

DATA SHEET
SE2547A: Dual-Band 802.11a/b/g/n Wireless LAN Front-End
Preliminary Information

Applications

- IEEE802.11b DSSS WLAN
- IEEE802.11g OFDM WLAN
- IEEE802.11a OFDM WLAN
- IEEE802.11n WLAN
- Access Points, PCMCIA, PC cards

Features

- All RF ports matched to 50 Ω
- Integrated 2.4 GHz PA, 5 GHz PA, TX Filter, T/R switches and diplexers
- Integrated Power Detector for each TX Chain
- 21 dBm O/P Power, 802.11b, 11 Mbits, ACPR = 35 dBc
- 18 dBm @ 3.0 % EVM, 802.11g, 54 Mbits
- 16.5 dBm @ 3.0 % EVM, 802.11a, 54 Mbits
- Single supply voltage: 3.3 V ± 10 %
- Lead free, RoHS compliant, Halogen free
- Thin lead free plated package, 5mm x 5mm x 1.0mm, LGA Package, MSL 3

Product Description

The SE2547A is a complete 802.11a/b/g/n WLAN RF front-end module providing all the functionality of the power amplifiers, filtering, power detector, Diversity switch, diplexers and associated matching. The SE2547A provides a complete 2.4 GHz and 5 GHz WLAN RF solution from the output of the transceiver to the antenna in an ultra compact form factor.

Designed for ease of use, all RF ports are matched to 50 Ω to simplify PCB layout and the interface to the transceiver RFIC. The SE2547A also includes a transmitter power detector for each band and transmit chain with 20 dB of dynamic range for each transmit chain. Each transmit chain has a separate digital enable control for transmitter power ramp on/off control. The power ramp rise/fall time is less than 0.7 μsec.

The device also provides a notch filter from 3.260-3.267 GHz and 3.28-3.89 GHz prior to the input of each 2.4 GHz and 5 GHz power amplifiers, respectively.

Ordering Information

Part No.	Package	Remark
SE2547A	32 pin LGA	Samples
SE2547A-R	32 pin LGA	Tape and Reel
SE2547A-EK1	N/A	Evaluation kit

Functional Block Diagram

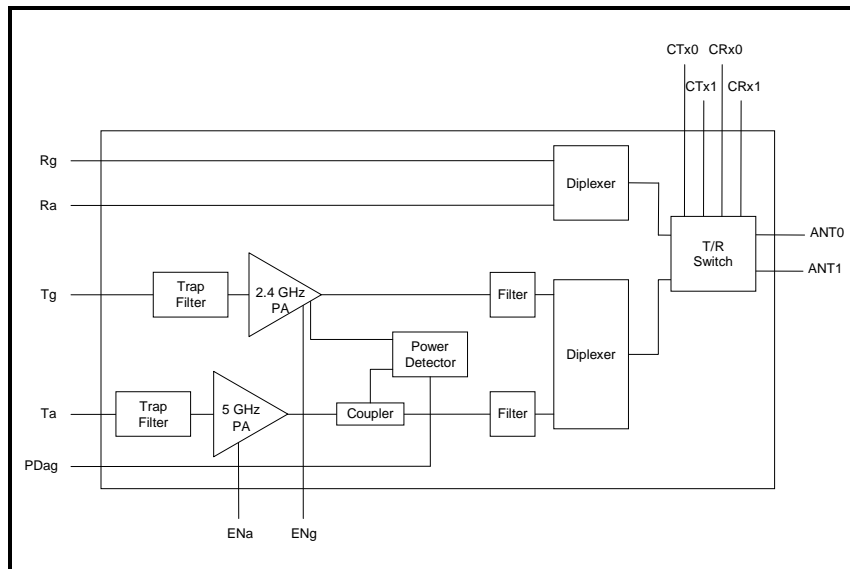

Figure 1: SE2547A Functional Block Diagram

DATA SHEET
SE2547A: Dual-Band 802.11a/b/g/n Wireless LAN Front-End
Preliminary Information

Pin Out Diagram

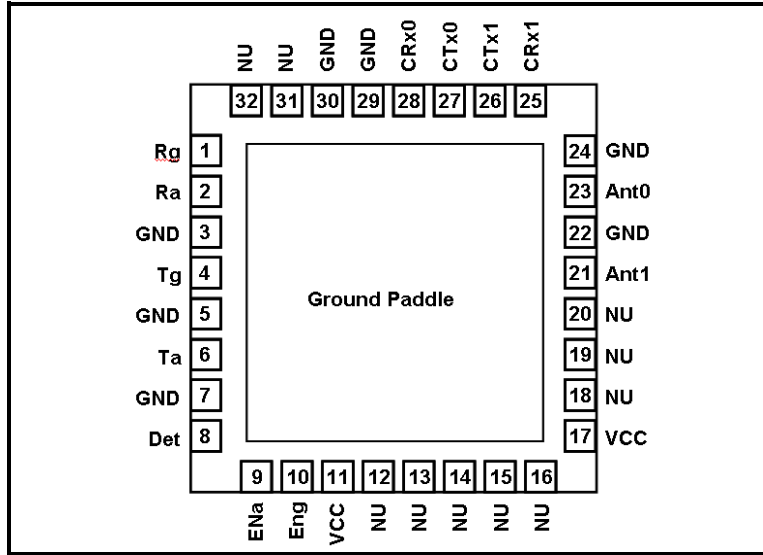

Figure 2: SE2547A Pin Out (Top View Through Package)

Pin Out Description

Pin No.	Name	Description
1	Rg	2.4 GHz RF Receive Output
2	Ra	5 GHz RF Receive Output
3	GND	Ground
4	Tg	2.4 GHz RF Transmit Input
5	GND	Ground
6	Ta	5 GHz RF Transmit Input
7	GND	Ground
8	Det	2.4/5 GHz Power Detector Output
9	ENa	5 GHz Power Amplifier Enable
10	ENg	2.4 GHz Power Amplifier Enable
11	VCC	Supply Voltage
12-16	NU	Not Used
17	VCC	Supply Voltage
18-20	NU	Not Used
21	Ant1	Antenna 1
22	GND	Ground
23	Ant0	Antenna 0
24	GND	Ground
25	CRx1	Switch Control, RX ↔ Antenna 1
26	CTx1	Switch Control, TX ↔ Antenna 1
27	CTx0	Switch Control, TX ↔ Antenna 0
28	CRx0	Switch Control, RX ↔ Antenna 0
29-30	GND	Ground

DATA SHEET
SE2547A: Dual-Band 802.11a/b/g/n Wireless LAN Front-End
Preliminary Information

Pin No.	Name	Description
31-32	NU	Not Used

Absolute Maximum Ratings

These are stress ratings only. Exposure to stresses beyond these maximum ratings may cause permanent damage to, or affect the reliability of the device. Avoid operating the device outside the recommended operating conditions defined below. This device is ESD sensitive. Handling and assembly of this device should be at ESD protected workstations.

Symbol	Definition	Min.	Max.	Unit
V _{CC}	Supply Voltage	-0.3	4.0	V
PU	ENa, ENg	-0.3	4.0	V
TX _{RF}	Ta, Tg	-	12.0	dBm
T _A	Operating Temperature Range	0	85	°C
T _{STG}	Storage Temperature Range	-40	150	°C

Recommended Operating Conditions

Symbol	Parameter	Min.	Typ.	Max.	Unit
V _{CC}	Supply Voltage	3.0	3.3	3.6	V
T _A	Ambient Temperature	0	25	85	°C

DC Electrical Characteristics

Conditions: V_{CC} = 3.3 V, T_A = 25 °C, as measured on Skyworks Solutions' SE2547A-EV1 evaluation board (de-embedded to device), all unused ports terminated with 50 ohms, unless otherwise noted

Symbol	Parameter	Conditions	Min.	Typ.	Max.	Unit
I _{CC-G}	Total 802.11g Transmit Supply Current	P _{OUT} = 18 dBm, 54 Mbps OFDM signal, 64 QAM ENg = 3.3 V, ENa = 0 V	-	170	-	mA
I _{CC-B}	Total 802.11b Transmit Supply Current	P _{OUT} = 21 dBm, 11 Mbps CCK signal, BT = 0.45, ENg = 3.3 V, ENa = 0 V	-	250	-	mA
I _{CC-A}	Total 802.11a Transmit Supply Current	P _{OUT} = 16 dBm, 54 Mbps OFDM signal, 64 QAM, ENa = 3.3 V, ENg = 0 V	-	175	200	mA
I _{CC_OFF}	Total Supply Current	No RF, ENg = ENa = 0 V	-	2	10	µA

DATA SHEET
SE2547A: Dual-Band 802.11a/b/g/n Wireless LAN Front-End
Preliminary Information

Logic Characteristics

Conditions: $V_{CC} = 3.3\text{ V}$, $T_A = 25\text{ }^\circ\text{C}$, as measured on Skyworks Solutions' SE2547A-EV1 evaluation board (de-embedded to device), all unused ports terminated with 50 ohms, unless otherwise noted.

Symbol	Parameter	Conditions	Min.	Typ.	Max.	Unit
V_{ENH}	Logic High Voltage for ENg, ENa (Module On)	-	1.8	-	V_{CC}	V
V_{ENL}	Logic Low Voltage ENg, ENa (Module Off)	-	0	-	0.5	V
I_{ENH}	Input Current Logic High Voltage (ENg, ENa)	-	-	100	200	μA
I_{ENL}	Input Current Logic Low Voltage (ENg, ENa)	-	-	0.2	-	μA

Switch Characteristics

Conditions: $V_{CC} = V_{EN} = 3.3\text{ V}$, $T_A = 25\text{ }^\circ\text{C}$, as measured on Skyworks Solutions' SE2547A-EV1 evaluation board (de-embedded to device), all unused ports terminated with 50 ohms, unless otherwise noted.

Symbol	Parameter	Conditions	Min.	Typ.	Max.	Unit
V_{CTL_ON}	Control Voltage (On State)	-	3.0	-	V_{CC}	V
V_{CTL_OFF}	Control Voltage (OFF State)	-	0.0	-	0.2	V
SW_{ON}	Low Loss Switch Control Voltage	High State = $V_{CTL_ON} - V_{CTL_OFF}$	2.8	-	V_{CC}	V
SW_{OFF}	High Loss Switch Control Voltage	Low State = $V_{CTL_OFF} - V_{CTL_OFF}$	0	-	0.3	V
I_{CTL_ON}	Switch Control Bias Current (RF Applied)	On pin (CTx0, CTx1, CRx0, CRx1) being driven high. RF Applied	-	-	100	μA
I_{CTL_ON}	Switch Control Bias Current (No RF)	On pin (CTx0, CTx1, CRx0, CRx1) being driven high. No RF	-	-	30	μA
C_{CTL}	Control Input Capacitance	-	-	-	100	pF

Switch Control Logic Table

Switch Logic				Operational Mode			
CTx0	CTx1	CRx0	CRx1	TX _{RF} – ANT_0	TX _{RF} – ANT_1	RX _{RF} – ANT_0	RX _{RF} – ANT_1
SW _{ON}	SW _{OFF}	SW _{OFF}	SW _{OFF}	ON	OFF	OFF	OFF
SW _{OFF}	SW_{ON}	SW _{OFF}	SW _{OFF}	OFF	ON	OFF	OFF
SW _{OFF}	SW _{OFF}	SW_{ON}	SW _{OFF}	OFF	OFF	ON	OFF
SW _{OFF}	SW _{OFF}	SW _{OFF}	SW_{ON}	OFF	OFF	OFF	ON
SW _{OFF}	SW _{OFF}	SW _{OFF}	SW _{OFF}	OFF	OFF	OFF	OFF
SW_{ON}	SW _{OFF}	SW_{ON}	SW _{OFF}	ON	OFF	ON	OFF

DATA SHEET
SE2547A: Dual-Band 802.11a/b/g/n Wireless LAN Front-End
Preliminary Information

Switch Logic				Operational Mode			
CTx0	CTx1	CRx0	CRx1	TX _{RF} – ANT_0	TX _{RF} – ANT_1	RX _{RF} – ANT_0	RX _{RF} – ANT_1
All Other States				Not Supported			

2.4 GHz AC Electrical Characteristics

2.4 GHz Transmit Characteristics

Conditions: $V_{CC} = 3.3\text{ V}$, $ENg = CTx0$ or $CTx1 = 3.3\text{ V}$, $ENa = CRx0$ and $CRx1 = 0\text{ V}$, $T_A = 25\text{ °C}$, as measured on Skyworks Solutions' SE2547A-EV1 evaluation board (de-embedded to device), all unused ports terminated with 50 ohms, unless otherwise noted.

Symbol	Parameter	Condition	Min.	Typ.	Max.	Unit
F_{IN}	Frequency Range	-	2400	-	2500	MHz
$P_{802.11g}$	Output power	54 Mbps OFDM signal, 64QAM, EVM = 3.0 %	-	18	-	dBm
$P_{802.11b}$	Output power	11 Mbps CCK signal, BT = 0.45 ACPR($\pm 11\text{MHz}$ offset) < -35 ACPR($\pm 22\text{MHz}$ offset) < -56	-	21	-	dBm
P_{1dB}	P1dB	-	23	25.5	-	dBm
S_{21}	Small Signal Gain	-	25	-	30	dB
ΔS_{21}	Small Signal Gain Variation Over Band	-	-	1.0	2.0	dB
$S_{213.2}$	Gain at Ref-VCO	3216.00 to 3256.00 MHz 3262.00 to 3263.21 MHz 3269.33 to 3276.00 MHz 3282.67 to 3312.00 MHz	-	0	9 4 9 17	dB
2f,3f	Harmonics	$P_{out} \leq 21\text{ dBm}$, 11Mbps, CCK	-	-	-45.2	dBm/MHz
t_r	Rise Time	10 % to 90% of final output power level	-	-	0.7	μs
t_{dr}, t_{df}	Delay and rise/fall Time	50 % of V_{EN} edge and 90/10 % of final output power level	-	-	0.7	μs
S_{11}	Input Return Loss	-	10	15	-	dB
STAB	Stability	CW, $P_{OUT} = 21\text{ dBm}$ 0.1 GHz – 21 GHz Load VSWR = 6:1	All non-harmonically related outputs less than -42 dBm/MHz			
R_u	Ruggedness	$T_g = 12\text{dBm}$, ANT load varies over 6:1 VSWR	No Irreversible damage			

DATA SHEET
SE2547A: Dual-Band 802.11a/b/g/n Wireless LAN Front-End
Preliminary Information

2.4 GHz Receive Characteristics

Conditions: $V_{CC} = 3.3\text{ V}$, $CR_X = 3.3\text{ V}$, $ENg = ENa = CTx = 0\text{ V}$, $T_A = 25\text{ }^\circ\text{C}$, as measured on Skyworks Solutions' SE2547A-EV1 evaluation board (de-embedded to device), all unused ports terminated with 50 ohms, unless otherwise noted.

Symbol	Parameter	Condition	Min.	Typ.	Max.	Unit
F _{OUT}	Frequency Range	-	2400	-	2500	MHz
RX _{IL}	Insertion Loss	-	-	1.8	2.0	dB
RX _{RL}	Return Loss	-	10	15	-	dB
Delta Rx	Delta between Rx paths	ANT_0 to RX _{RF} or ANT_1 to RX _{RF}	-	-	0.5	dB
TG _{LEAK}	TX Power Leakage	CTx0 or CTx1 = SWON, CRx0 = CRx1 = SWOFF, Device transmitting (TXEN = 3.3 V) 18.0 dBm @ ANT0 or ANT1, Power measured @ RX_OUT	-	-	-3	dBm
TR _{ISOL-LB}	Isolation in Loop Back Mode	CTx0 = CRx0 = SWON, CTx1 = CRx1 = SWOFF, Device transmitting (TXEN = 3.3V) small signal @ANT0	-	5	26	dB
ATT _g	Antenna to Rx isolation	Small signal input into ANT_0 or ANT_1, Power measured @ RX _{RF} , CTx0 (Ant1 to Rx Iso) OR CTx1 (Ant0 to Rx Iso) = SWON, CRx0 and CRx1 = SWOFF	21	-	28	dB
IS _{ANTG}	Antenna to Antenna Isolation	-	-	18	-	dB

DATA SHEET
SE2547A: Dual-Band 802.11a/b/g/n Wireless LAN Front-End
Preliminary Information

5 GHz AC Electrical Characteristics

5 GHz Transmit Characteristics

Conditions: $V_{CC} = 3.3\text{ V}$, E_{NA} and CT_{X0} or $CT_{X1} = 3.3\text{ V}$, $E_{NG} = CR_{X0} = CR_{X1} = 0\text{ V}$, $T_A = 25\text{ }^\circ\text{C}$, as measured on Skyworks Solutions' SE2547A-EV1 evaluation board (de-embedded to device), all unused ports terminated with 50 ohms, unless otherwise noted.

Symbol	Parameter	Condition	Min.	Typ.	Max.	Unit
F_{IN}	Frequency Range	-	4900	-	5875	MHz
$P_{802.11a}$	Nominal Output Power	54 Mbps OFDM signal, 64 QAM, EVM = 3.0 %	-	16.5	-	dBm
P_{1dB}	P1dB	-	21	22.5	-	dBm
S_{21}	Small Signal Gain	-	22.5	-	29	dB
ΔS_{21}	Small Signal Gain Variation Over 40 MHz Channel		-	-	0.5	dB
	Small Signal Gain Variation Over sub-bands	4.9 – 5.1 GHz 5.15 – 5.7 GHz 5.7 – 5.85 GHz	-	1	3	dB
$S_{21.6}$	Gain at Ref-VCO $\div 2$	1640.00 to 1942.00 MHz	-	-	21	dB
$S_{213.2}$	Gain at Ref-VCO	3280 to 3800 MHz	-	-	9	dB
		3828 to 3872 MHz	-	-	4	
		3882 to 3885 MHz	-	-	9	
$2f, 3f$	Harmonics @ 16dBm, 54Mbps, 802.11a	5300 – 5850 MHz	-	-	-48.2	dBm/MHz
		All other bands	-	-	-35.0	
t_r	Rise Time	10 % to 90% of final output power level	-	-	0.7	μs
t_{dr}, t_{df}	Delay and rise/fall Time	50 % of V_{EN} edge and 90/10 % of final output power level	-	-	0.7	μs
S_{11}	Input Return Loss	-	10	15	-	dB
STAB	Stability	64 QAM, $P_{OUT} = 16\text{ dBm}$ 0.1 GHz – 21 GHz Load VSWR = 6:1	All non-harmonically related outputs less than -42 dBm/MHz			
R_u	Ruggedness	$T_a = 12\text{ dBm}$, ANT load varies over 6:1 VSWR	No Irreversible damage			

DATA SHEET
SE2547A: Dual-Band 802.11a/b/g/n Wireless LAN Front-End
Preliminary Information

5 GHz Receive Characteristics

Conditions: $V_{CC} = 3.3\text{ V}$, $CRx0$ or $CRx1 = 3.3\text{ V}$, $ENG = ENa = CTx0 = CTx1 = 0\text{ V}$, $T_A = 25\text{ }^\circ\text{C}$, as measured on Skyworks Solutions' SE2547A-EV1 evaluation board (de-embedded to device), all unused ports terminated with 50 ohms, unless otherwise noted.

Symbol	Parameter	Condition	Min.	Typ.	Max.	Unit
F _{OUT}	Frequency Range	-	4900	-	5850	MHz
RX _{IL}	Insertion Loss	-	-	2	2.5	dB
RX _{RL}	Return Loss	-	10	15	-	dB
Delta Rx	Delta between Rx paths	ANT_0 to RX _{RF} or ANT_1 to RX _{RF}	-	-	0.5	dB
T _{LEAK}	Tx Power Leakage	CTx0 or CTx1 = SWON, CRx0 = CRx1 = SWOFF, Device transmitting (TXEN = 3.3 V) 18.0 dBm @ ANT0 or ANT1, Power measured @ RX_OUT	-	-	0	dBm
TR _{ISOL-LB}	Isolation in Loop Back Mode	CTx0 = CRx0 = SWON, CTx1 = CRx1 = SWOFF, Device transmitting (TXEN = 3.3V) small signal @ANT0	-	5	26	dB
ATT _a	Antenna to Rx isolation	Small signal input into ANT_0 or ANT_1, Power measured @ RX _{RF} , CTx0 (Ant1 to Rx Iso) OR CTx1 (Ant0 to Rx Iso) = SWON, CRx0 and CRx1 = SWOFF	16	-	27	dB
IS _{ANTA}	Antenna to Antenna Isolation	-	-	18	-	dB

DATA SHEET
SE2547A: Dual-Band 802.11a/b/g/n Wireless LAN Front-End
Preliminary Information

2.4 GHz Power Detector Characteristics

Conditions: $V_{CC} = 3.3\text{ V}$, $ENg = CTx = 3.3\text{ V}$, $ENa = CRx = 0\text{ V}$, $T_A = 25\text{ }^\circ\text{C}$, as measured on Skyworks Solutions' SE2547A-EV1 evaluation board (de-embedded to device), all unused ports terminated with 50 ohms, unless otherwise noted.

Symbol	Parameter	Condition	Min.	Typ.	Max.	Unit
F _{OUT}	Frequency Range	-	2400	-	2500	MHz
PDR	Power detect range, peak power	Measured at ANT0 or ANT1	0	-	22	dBm
PDZ _{OUT}	DC Output impedance	-	-	200	-	Ω
PDZ _{OUT}	DC Output impedance	-	-	2.7	-	k Ω
PDV _{P21}	Output Voltage, P _{OUT} = 21dBm	-	-	0.85	-	V
PDV _{P15}	Output Voltage, P _{OUT} = 15dBm	-	-	0.55	-	V
PDV _{pnoRF}	Output Voltage, P _{OUT} = No RF	-	-	0.30	-	V
LPF _{-3dB}	Power detect low pass filter -3dB corner frequency	Load = high impedance Typ: 500 k Ω	-	1500	-	KHz

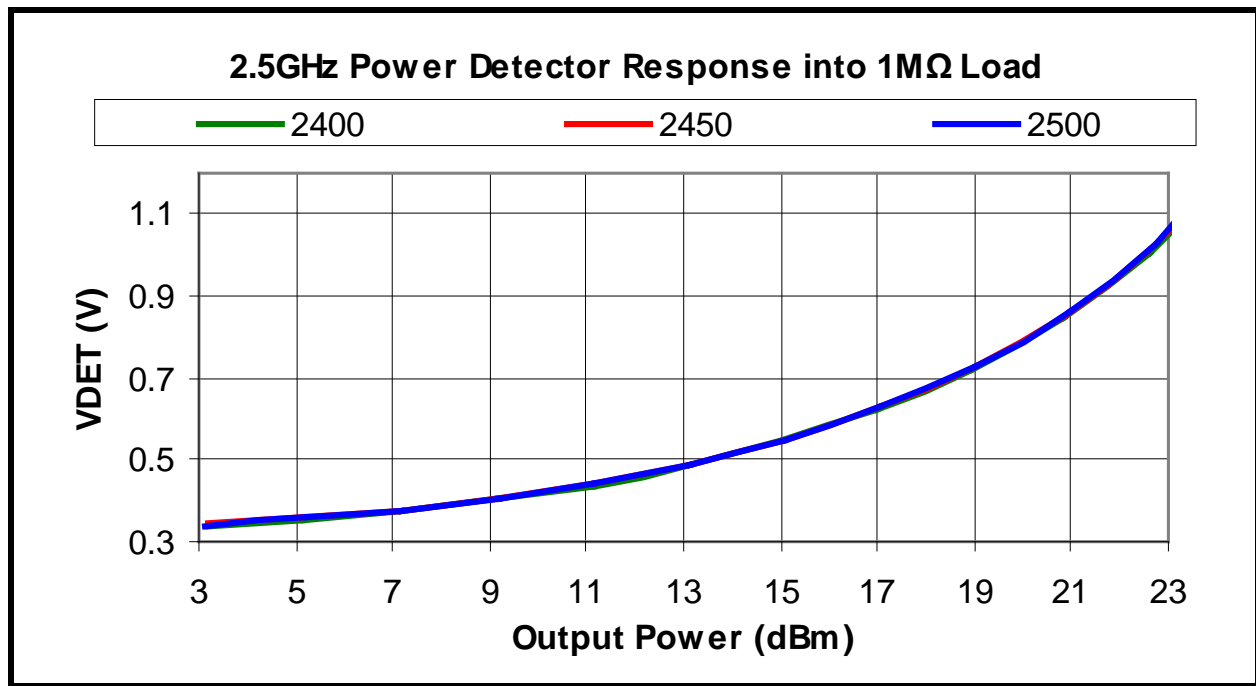

Figure 3: SE2547A Power Detector vs. Output Power over Frequency (CW Signal)

DATA SHEET
SE2547A: Dual-Band 802.11a/b/g/n Wireless LAN Front-End
Preliminary Information

5 GHz Power Detector Characteristic

Conditions: $V_{CC} = 3.3\text{ V}$, $E_{NA} = CTx0$ or $CTx1 = 3.3\text{ V}$, $E_{NG} = CRx0 = CRx1 = 0\text{ V}$, $T_A = 25\text{ }^\circ\text{C}$, as measured on Skyworks Solutions' SE2547A-EV1 evaluation board (de-embedded to device), all unused ports terminated with 50 ohms, unless otherwise noted.

Symbol	Parameter	Condition	Min.	Typ.	Max.	Unit
F _{OUT}	Frequency Range	-	4900	-	5850	MHz
PDR	Power detect range, peak power	Measured at ANT	0	-	21	dBm
PDZ _{OUT}	DC Output impedance	-	-	200	-	Ω
PDV _{p18}	Output Voltage, P _{OUT} = 18dBm	-	-	0.80	-	V
PDV _{p15}	Output Voltage, P _{OUT} = 15dBm	-	-	0.62	-	V
PDV _{NoRF}	Output Voltage, P _{OUT} = No RF	-	-	0.30	-	V
LPF _{-3dB}	Power detect low pass filter -3dB corner frequency	Load = high impedance Typ: 500 k Ω	-	1500	-	KHz

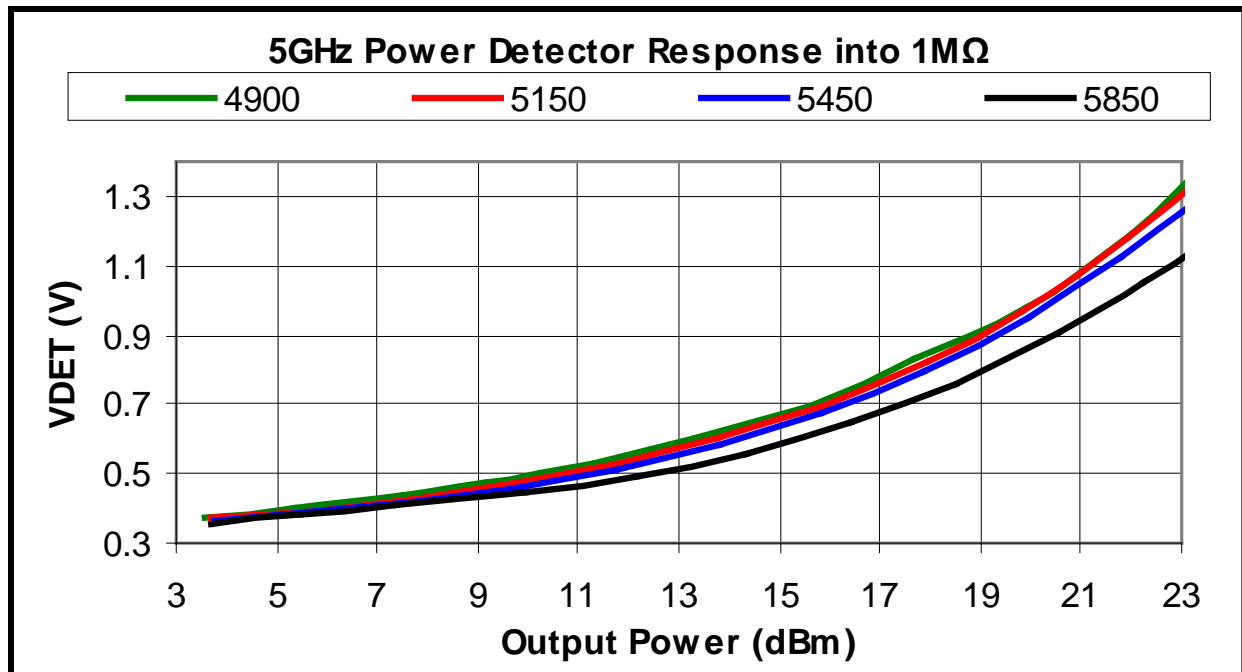

Figure 4: Preliminary SE2547A Power Detector vs. Output Power over Frequency (CW Signal)

DATA SHEET
SE2547A: Dual-Band 802.11a/b/g/n Wireless LAN Front-End
Preliminary Information

Package Handling Information

Because of its sensitivity to moisture absorption, instructions on the shipping container label must be followed regarding exposure to moisture after the container seal is broken, otherwise, problems related to moisture absorption may occur when the part is subjected to high temperature during solder assembly. The SE2547A is capable of withstanding a Pb free solder reflow. Care must be taken when attaching this product, whether it is done manually or in a production solder reflow environment. If the part is manually attached, precaution should be taken to insure that the device is not subjected to temperatures above its rated peak temperature for an extended period of time. For details on both attachment techniques, precautions, and handling procedures recommended, please refer to:

- “Land Grid Array Module Solder Reflow & Rework Information”, *Document Number QAD-00046*
- “Handling, Packing, Shipping and Use of Moisture Sensitive LGA”, *Document Number QAD-00047*

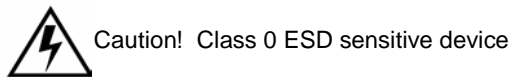

Product Branding

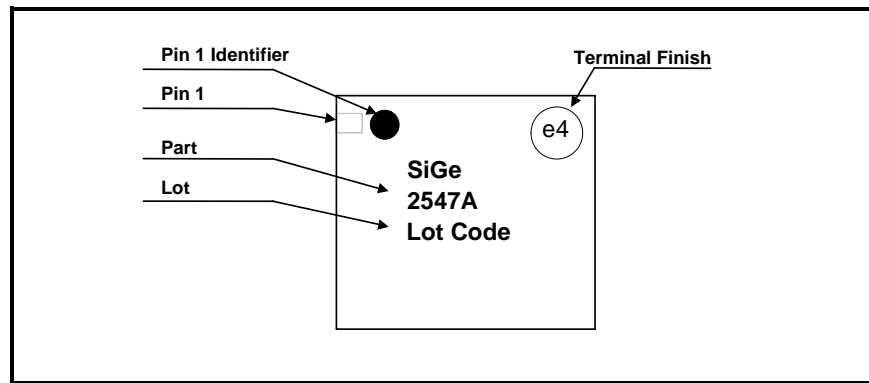

Figure 7: SE2547A Branding Information

DATA SHEET
SE2547A: Dual-Band 802.11a/b/g/n Wireless LAN Front-End
Preliminary Information

Tape and Reel Information

Production quantities of this product are shipped in a standard tape-and-reel format. Specific tape and reel dimensions and sizing is shown in Table 1 and Figure .

Parameter	Value
Devices Per Reel	3000
Reel Diameter	13 inches

Table 1: Tape and Reel Dimensions

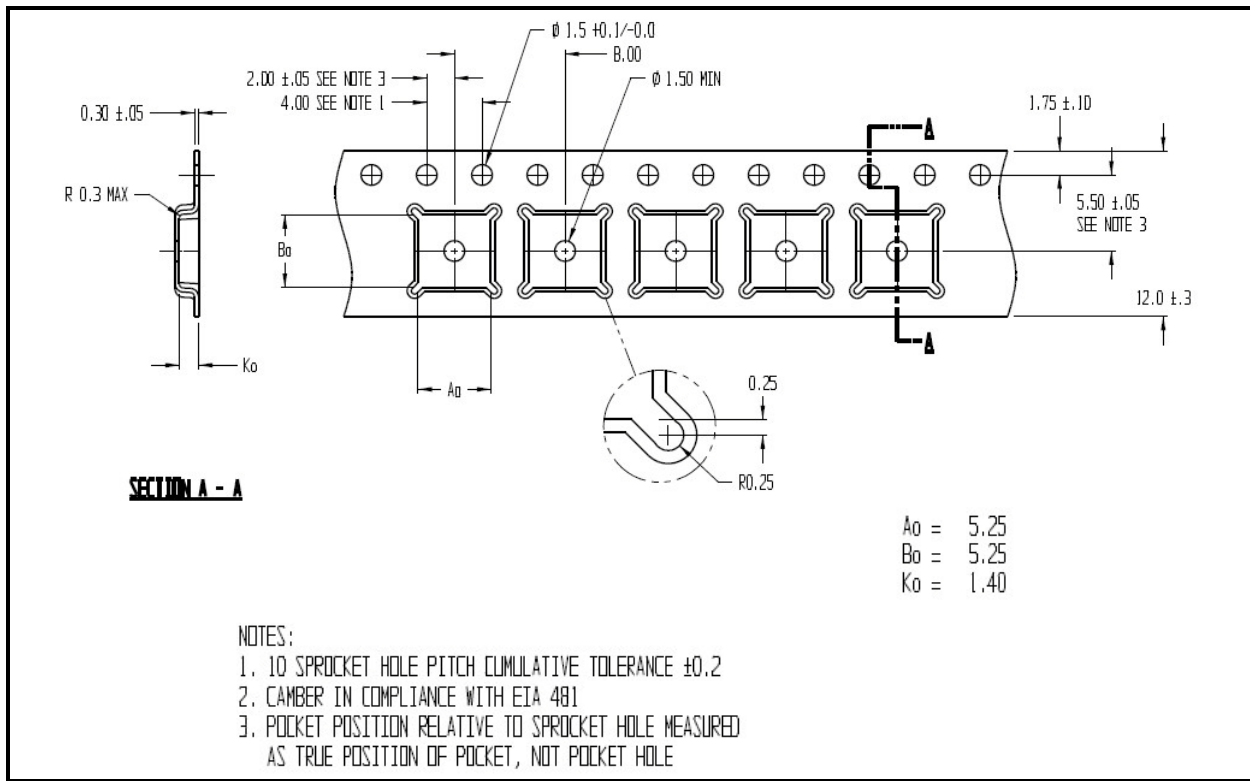

Figure 8: Detailed Tape and Reel Information (All dimensions in Millimeters)

Document Change History

Revision	Date	Notes
1.0	December 6, 2006	Created
1.1	March 24, 2007	Updated Pin Names Updated output power in 2GHz channel Updated 5GHz detector characteristics
1.2		No changes released to production
1.3	July 19, 2007	Updated TX and RX specifications based on measured data, including power, gain, return loss in both 2GHz and 5GHz channels



DATA SHEET
SE2547A: Dual-Band 802.11a/b/g/n Wireless LAN Front-End
Preliminary Information

Revision	Date	Notes
1.4	October 1, 2007	Updated output power, and gain profile in the 2GHz and 5GHz channels Updated current consumption in the 2GHz and 5GHz channels Updated switch control logic table
1.5	October 30, 2007	Corrected labels of figures.
1.6	November 5, 2007	Update the 5GHz detector characteristics
1.7	March 28, 2008	Updated switch table
1.8	March 15, 2009	Updated for Halogen Free Added recommended landing pattern
1.9	May 26, 2009	Amended back page
2.0	Mar 28, 2012	Updated with Skyworks logo and disclaimer statement

Copyright © 2012 Skyworks Solutions, Inc. All Rights Reserved.

Information in this document is provided in connection with Skyworks Solutions, Inc. ("Skyworks") products or services. These materials, including the information contained herein, are provided by Skyworks as a service to its customers and may be used for informational purposes only by the customer. Skyworks assumes no responsibility for errors or omissions in these materials or the information contained herein. Skyworks may change its documentation, products, services, specifications or product descriptions at any time, without notice. Skyworks makes no commitment to update the materials or information and shall have no responsibility whatsoever for conflicts, incompatibilities, or other difficulties arising from any future changes.

No license, whether express, implied, by estoppel or otherwise, is granted to any intellectual property rights by this document. Skyworks assumes no liability for any materials, products or information provided hereunder, including the sale, distribution, reproduction or use of Skyworks products, information or materials, except as may be provided in Skyworks Terms and Conditions of Sale.

THE MATERIALS, PRODUCTS AND INFORMATION ARE PROVIDED "AS IS" WITHOUT WARRANTY OF ANY KIND, WHETHER EXPRESS, IMPLIED, STATUTORY, OR OTHERWISE, INCLUDING FITNESS FOR A PARTICULAR PURPOSE OR USE, MERCHANTABILITY, PERFORMANCE, QUALITY OR NON-INFRINGEMENT OF ANY INTELLECTUAL PROPERTY RIGHT; ALL SUCH WARRANTIES ARE HEREBY EXPRESSLY DISCLAIMED. SKYWORKS DOES NOT WARRANT THE ACCURACY OR COMPLETENESS OF THE INFORMATION, TEXT, GRAPHICS OR OTHER ITEMS CONTAINED WITHIN THESE MATERIALS. SKYWORKS SHALL NOT BE LIABLE FOR ANY DAMAGES, INCLUDING BUT NOT LIMITED TO ANY SPECIAL, INDIRECT, INCIDENTAL, STATUTORY, OR CONSEQUENTIAL DAMAGES, INCLUDING WITHOUT LIMITATION, LOST REVENUES OR LOST PROFITS THAT MAY RESULT FROM THE USE OF THE MATERIALS OR INFORMATION, WHETHER OR NOT THE RECIPIENT OF MATERIALS HAS BEEN ADVISED OF THE POSSIBILITY OF SUCH DAMAGE.

Skyworks products are not intended for use in medical, lifesaving or life-sustaining applications, or other equipment in which the failure of the Skyworks products could lead to personal injury, death, physical or environmental damage. Skyworks customers using or selling Skyworks products for use in such applications do so at their own risk and agree to fully indemnify Skyworks for any damages resulting from such improper use or sale.

Customers are responsible for their products and applications using Skyworks products, which may deviate from published specifications as a result of design defects, errors, or operation of products outside of published parameters or design specifications. Customers should include design and operating safeguards to minimize these and other risks. Skyworks assumes no liability for applications assistance, customer product design, or damage to any equipment resulting from the use of Skyworks products outside of stated published specifications or parameters.

Skyworks, the Skyworks symbol, and "Breakthrough Simplicity" are trademarks or registered trademarks of Skyworks Solutions, Inc., in the United States and other countries. Third-party brands and names are for identification purposes only, and are the property of their respective owners. Additional information, including relevant terms and conditions, posted at www.skyworksinc.com, are incorporated by reference.