

Extended/Direct Handle Motor Disconnect Switch

The VKA...N series can be used with extended and direct handles (see page 6-11 for details).

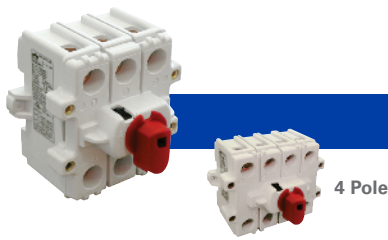

Catalog Number	VKA380N	VKA3100N	VKA3125N	VKA3160N
No. of Poles	3 (4 pole - VKA480N)	3 (4 pole - VKA4100N)	3 (4 pole - VKA4125N)	3 (4 pole - VKA4160N)
General Purpose Current	80 A	100 A	125 A	150 A
Maximum Voltage	600V AC	600V AC	600V AC	600V AC
Motor FLA @ 480V AC	-	-	-	-
Motor FLA @ 600V AC	47 A	54 A	68 A	83 A

Horsepower Rating/HP	VKA380N		VKA3100N		VKA3125N		VKA3160N	
	1 Phase	3 Phase	1 Phase	3 Phase	1 Phase	3 Phase	1 Phase	3 Phase
110-120V AC	3	7.5	3	7.5	5	10	7.5	10
200V AC	7.5	10	7.5	15	10	20	10	25
208V AC	7.5	15	7.5	15	10	20	10	25
220-240V AC	7.5	15	10	20	15	25	15	30
265V AC	10	20	10	20	15	25	20	30
277V AC	10	20	10	20	15	30	20	30
380-415V AC	15	25	15	30	20	40	25	50
440-480V AC	20	30	20	40	25	50	30	60
550-600V AC	25	40	30	50	30	60	40	75

Short Circuit Withstand Rating at 600 V with Max. Fuse Size/Class:	VKA380N	VKA3100N	VKA3125N	VKA3160N
K5	150 A	150 A	150 A	150 A
RK5	150 A	150 A	150 A	150 A
RK1	-	-	-	-
J	200 A	200 A	200 A	200 A

Terminal Size Acceptability	VKA380N	VKA3100N	VKA3125N	VKA3160N
(Cu Conductors only, 75 °C)	8-1/0 AWG	8-1/0 AWG	8-1/0 AWG	8-1/0 AWG
Terminal Torque	50 lb. in. (5.6 Nm)	50 lb. in. (5.6 Nm)	50 lb. in. (5.6 Nm)	50 lb. in. (5.6 Nm)
Screw Head Type	5 mm Allen Key	5 mm Allen Key	5 mm Allen Key	5 mm Allen Key

Dimensions

(to convert to inches multiply by 0.03937)

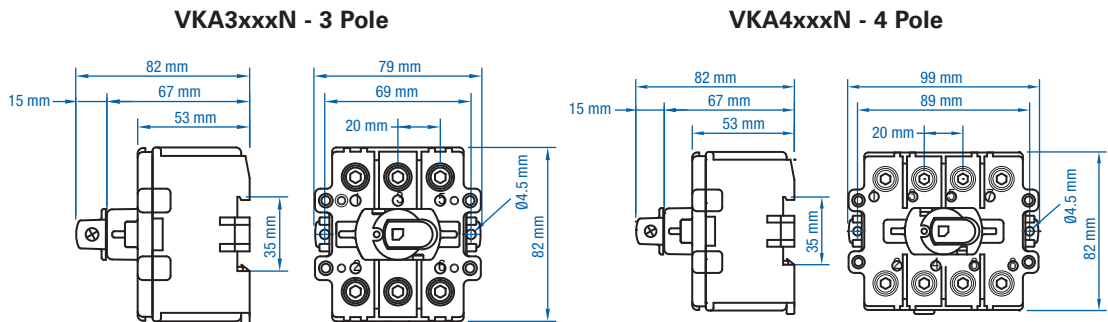

Weight	VKA380N	VKA3100N	VKA3125N	VKA3160N
	0.480 kg (1.058 lb.) (3 pole) 0.620 kg (1.367 lb.) (4 pole)	0.480 kg (1.058 lb.) (3 pole) 0.620 kg (1.367 lb.) (4 pole)	0.480 kg (1.058 lb.) (3 pole) 0.620 kg (1.367 lb.) (4 pole)	0.480 kg (1.058 lb.) (3 pole) 0.620 kg (1.367 lb.) (4 pole)

Suitable Accessories

Extended Handle Applications (Door Interlock Mechanism)

Shaft	VKA380N	VKA3100N	VKA3125N	VKA3160N
Handles	L(1,2,3)00AD11-ST LK10 (Y/R) UL, LK11 (Y/R) U	L(1,2,3)00AD11-ST LK10 (Y/R) UL, LK11 (Y/R) U	L(1,2,3)00AD11-ST LK10 (Y/R) UL, LK11 (Y/R) U	L(1,2,3)00AD11-ST LK10 (Y/R) UL, LK11 (Y/R) U
Auxiliary Switch	VKA1.V, VKA2.V	VKA1.V, VKA2.V	VKA1.V, VKA2.V	VKA1.V, VKA2.V
Fuse Holder	-	-	-	-

Direct Handle Applications

Handle for 3 & 4 Pole	VKA380N	VKA3100N	VKA3125N	VKA3160N
Door Mounting Kits	K/VKA3-4P (Y/R) OKA/VKA x	K/VKA3-4P (Y/R) OKA/VKA x	K/VKA3-4P (Y/R) OKA/VKA x	K/VKA3-4P (Y/R) OKA/VKA x