

PCB terminal, Wire protection, No. of poles: 3, Width: 15.7 mm, Colour: Dark grey

Business data

Article number	10002.4
Article name	PK 100/3/5,00-V DG
GTIN (EAN)	4044211000042
Packaging unit	50
Quantity unit	PC
Packaging type	Carton
Type of banding	Without
Weight per piece (not including packaging)	3.4 g
Weight per piece (including packaging)	3.87 g
Unit of weight	G
Customs number	85369010
Country of origin	TN
Prio-Article	10002.1

Technical data

Dimensions

Length	9 mm
Length of the pin	4.5 mm
Width	15.7 mm
Width left	3.2 mm
Width right	2.5 mm
Height	12.5 mm
Drill hole diameter	1.3 mm
Diameter of connecting pin	1 mm
Pitch	5 mm

Ratings

Rated voltage	250 V
Rated current	24 A
Rated cross-section	2.5 mm ²
Rated impulse voltage	2 kV
Overvoltage category	III
Contamination degree	3

Technical data

Connection data

Connection principle	Wire protection
Connection type of PCB	Solder connection
Type of attachment to circuit board	Connecting contact
Angle of PCB/wire connection	0°/180° (horizontal)
No. of poles	3
Number of levels	1
Wire cross-section single-core (rigid) / stranded, min.	0.2 mm ²
Wire cross-section single core (rigid)/stranded, max.	2.5 mm ²
Wire cross-section stranded, min.	0.2 mm ²
Wire cross-section stranded, max.	2.5 mm ²
Wire cross-section stranded with wire-end ferrules,min.	0.2 mm ²
Wire cross-section stranded with wire-end ferrules,max.	2.5 mm ²
Wire cross-section AWG, min.	22
Wire cross-section AWG, max.	12
Stripping length	7 mm
Screw threading	M 3
Torque	0.5 Nm

Materials

Insulation housing	Polyamide 6.6
Flammability class UL 94	V-0
Working temperature, min.	-30 °C
Working temperature, max.	105 °C
Clamping element	Brass
Screws	Steel
Wire protection	Stainless steel

Technical data

Further technical data

Storage temperature, min.	-40 °C
Storage temperature, max.	105 °C
Insulation resistance	1*10 ¹³ Ohm x cm
Creepage-current resistance	CTI 600
Glow wire flammability index GWFI	GWFI 850
GWFI after-glow time	30 Sek.
Glow wire ignition temperature GWIT	GWIT 775 °C
GWIT exposure time	5 Sek.
Connection cycles, in compliance with standard	5
Recommended wave soldering temperature	265 °C
Recommended wave soldering duration, min.	3 Sek.
Recommended wave soldering duration, max.	4 Sek.

Environmental Product Compliance

REACH Conform	No
REACH Reference date	2022-06-10
REACH Candidate Substance Note	No
REACH CAS 1 Substance	LEAD
REACH CAS 1 Percent minimal	0.1 %
REACH CAS 1 Percent maximum	4 %
REACH CAS 1 Number	7439-92-1
RoHS Conform	yes
RoHS Exception rule	6c

Approvals

cUL Recognized

cUL approval	CSA 22.2 No.158
cUL Usegroup B: rated voltage	300 V
cUL Usegroup B: rated current	20 A
cUL Usegroup D: rated voltage	300 V
cUL Usegroup D: rated current	10 A
cUL wire cross-section single-core (rigid) AWG, min.	22
cUL wire cross-section single-core (rigid) AWG, max.	12
cUL wire cross-section stranded AWG, min.	12
cUL wire cross-section stranded AWG, max.	22
cUL torque	0.4499999881 Nm
cUL wire material	Cu
cUL Recognized	1

UL Recognized

UL approval	UL 1059
UL Usegroup B: rated voltage	300 V
UL Usegroup B: rated current	20 A
UL Usegroup D: rated voltage	300 V
UL Usegroup D: rated current	10 A
UL wire cross-section single-core (rigid) AWG, min.	22
UL wire cross-section single-core (rigid) AWG, max.	12
UL wire cross-section stranded AWG, min.	12
UL wire cross-section stranded AWG, max.	22
UL torque	4 Lb In
UL wire material	Cu
UL factory wiring	1
UL field wiring	1
UL Recognized	1

Approvals

VDE approval

VDE approval	DIN EN 60998
VDE approval granted	yes
VDE rated voltage	250 V
VDE rated current	24 A
VDE rated current wire cross-section rigid, max.	24 A
VDE rated current wire cross-section stranded, max.	24 A
VDE rated impulse voltage	2 kV
VDE wire cross-section rigid, min.	0.5 mm ²
VDE wire cross-section rigid, max.	2.5 mm ²
VDE wire cross-section stranded, min.	0.5 mm ²
VDE wire cross-section stranded, max.	2.5 mm ²
VDE screw threading	M 3
VDE torque	0.5 Nm
VDE overvoltage category	III
VDE contamination degree	3

Media

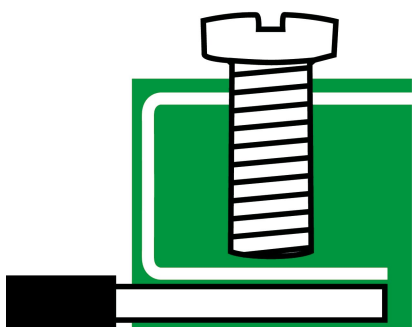

M3

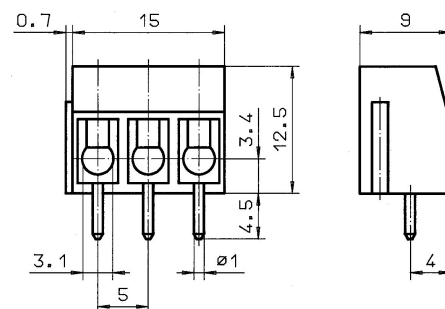

Accessories
