



# 10/100/1000 Base-T Ethernet LAN Switch

## General Description

The MAX4890/MAX4891/MAX4892 high-speed analog switches meet the needs of 10/100/1000 Base-T applications. These devices switch the signals from two interface transformers and connect the signals to a single 10/100/1000 Base-T Ethernet PHY, simplifying docking station design and reducing manufacturing costs. The MAX4890/MAX4891/MAX4892 can also route signals from a common interface transformer to two different boards in board-redundancy applications.

The MAX4890/MAX4891/MAX4892 switches provide an extremely low capacitance and on-resistance to meet Ethernet insertion and return-loss specifications. The MAX4891/MAX4892 feature one and three built-in LED switches, respectively.

The MAX4890/MAX4891/MAX4892 are available in space-saving 32- and 36-lead TQFN packages, significantly reducing the required PC board area. These devices operate over the -40°C to +85°C temperature range.

## Applications

Notebooks and Docking Stations  
Servers and Routers with Ethernet Interfaces  
Board-Level Redundancy Protection  
SONET/SDH Signal Routing  
T3/E3 Redundancy Protection  
Video Switching

## Features

- ◆ Single +3.0V to +3.6V Power-Supply Voltage
- ◆ Low On-Resistance ( $R_{ON}$ ): 4Ω (typ), 6.5Ω (max)
- ◆ Ultra-Low On-Capacitance ( $C_{ON}$ ): 6.5pF (typ)
- ◆ Low < 200ps Bit-to-Bit Skew
- ◆ -3dB Bandwidth: 1GHz
- ◆ Optimized Pin-Out for Easy Transformer and PHY Interface
- ◆ Built-In LED Switches for Switching Indicators to Docking Station
- ◆ Low 450μA (max) Quiescent Current
- ◆ Bidirectional 8 to 16 Multiplexer/Demultiplexer
- ◆ Space-Saving Packages
  - 32-Pin, 5mm x 5mm, TQFN Package
  - 36-Pin, 6mm x 6mm, TQFN Package

## Ordering Information

PART	PIN-PACKAGE	LED SWITCHES
MAX4890ETJ	32 TQFN-EP*	—
MAX4891ETJ	32 TQFN-EP*	1
MAX4892ETX	36 TQFN-EP*	3

**Note:** All devices are specified for operation in the -40°C to +85°C temperature range.

\*EP = Exposed pad.

## Pin Configurations

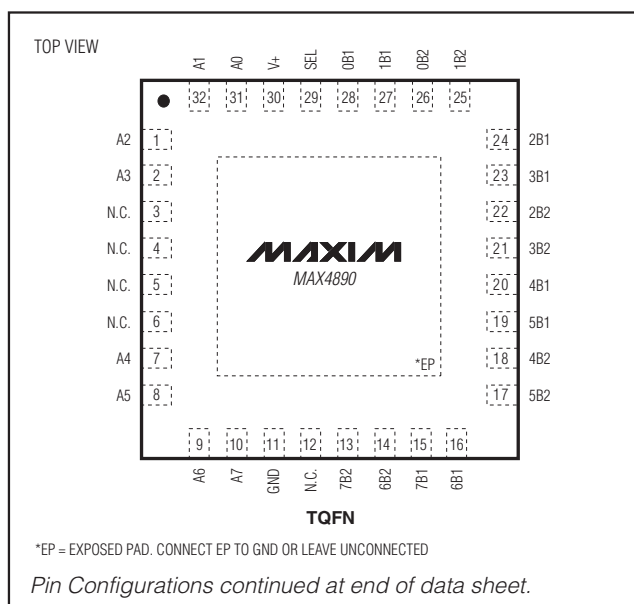

Functional Diagrams and Typical Operating Circuit appear at end of data sheet.



# 10/100/1000 Base-T Ethernet LAN Switch

## ABSOLUTE MAXIMUM RATINGS

V+ .....	-0.3V to +4V	Continuous Power Dissipation (T <sub>A</sub> = +70°C)	
SEL (Note 1) .....	-0.3V to (V+ +0.3V)	32-Pin TQFN (derate 34.5mW/°C above +70°C) .....	2.76W
A <sub>-</sub> , B <sub>-</sub> , LED <sub>-</sub> , LED <sub>-</sub> .....	-0.3V to (V+ +0.3V)	36-Pin TQFN (derate 26.3mW/°C above +70°C) .....	2.11W
Continuous Current (A <sub>-</sub> to B <sub>-</sub> ) .....	±120mA	Operating Temperature Range .....	-40°C to +85°C
Continuous Current (LED <sub>-</sub> to LED <sub>-</sub> ) .....	±30mA	Junction Temperature .....	+150°C
Peak Current (A <sub>-</sub> to B <sub>-</sub> ) .....	±240mA	Storage Temperature Range .....	-65°C to +150°C
(pulsed at 1ms, 10% duty cycle) .....	±240mA	Lead Temperature (soldering, 10s) .....	+300°C

**Note 1:** Signals on SEL, exceeding V+ or GND, are clamped by internal diodes. Limit forward-diode current to maximum current rating.

Stresses beyond those listed under "Absolute Maximum Ratings" may cause permanent damage to the device. These are stress ratings only, and functional operation of the device at these or any other conditions beyond those indicated in the operational sections of the specifications is not implied. Exposure to absolute maximum rating conditions for extended periods may affect device reliability.

## ELECTRICAL CHARACTERISTICS

(V+ = +3V to +3.6V, T<sub>A</sub> = T<sub>MIN</sub> to T<sub>MAX</sub>, unless otherwise noted. Typical values are at V+ = 3.3V, T<sub>A</sub> = +25°C.) (Note 2)

PARAMETER	SYMBOL	CONDITIONS	MIN	TYP	MAX	UNITS
<b>ANALOG SWITCH</b>						
On-Resistance	R <sub>ON</sub>	V+ = 3V, I <sub>A-</sub> = -40mA, 1.5V ≤ V <sub>A-</sub> ≤ V+	T <sub>A</sub> = +25°C	4	5.5	Ω
			T <sub>MIN</sub> to T <sub>MAX</sub>		6.5	
On-Resistance LED Switches	R <sub>ONLED</sub>	V+ = 3V, I <sub>LED-</sub> = -40mA, 1.5V ≤ V <sub>A-</sub> ≤ V+, MAX4891/MAX4892			40	Ω
On-Resistance Match Between Channels	ΔR <sub>ON</sub>	V+ = 3V, I <sub>A-</sub> = -40mA, 1.5V ≤ V <sub>A-</sub> ≤ V+ (Note 3)	T <sub>A</sub> = +25°C	0.5	1.5	Ω
			T <sub>MIN</sub> to T <sub>MAX</sub>		2	
On-Resistance Flatness	R <sub>FLAT(ON)</sub>	V+ = 3V, I <sub>A-</sub> = -40mA, V <sub>A-</sub> = 1.5V, 2.7V		0.01		Ω
Off-Leakage Current	I <sub>LA(OFF)</sub>	V+ = 3.6V, V <sub>A-</sub> = 0.3V, 3.3V V <sub>B1</sub> or V <sub>B2</sub> = 3.3V, 0.3V	-1		+1	μA
On-Leakage Current	I <sub>LA(ON)</sub>	V+ = 3.6V, V <sub>A-</sub> = 0.3V, 3.3V V <sub>B1</sub> or V <sub>B2</sub> = 0.3V, 3.3V or floating	-1		+1	
<b>ESD PROTECTION</b>						
ESD Protection		Human Body Model		±2		kV
<b>SWITCH AC PERFORMANCE</b>						
Insertion Loss	I <sub>LOS</sub>	Insertion loss with typical transformer, R <sub>L</sub> = 100Ω, 1MHz < f < 100MHz, Figure 1 (Note 3)		0.6		dB
Return Loss	R <sub>LOS1</sub>	Return loss with typical transformer, R <sub>L</sub> = 100Ω, return	1MHz < f < 40MHz	-19		dB
	R <sub>LOS2</sub>	loss, f in MHz, Figure 2 (Note 3)	40MHz < f < 100MHz	-13 +20log (f/80)		

# 10/100/1000 Base-T Ethernet LAN Switch

MAX4890/MAX4891/MAX4892

## ELECTRICAL CHARACTERISTICS (continued)

(V+ = +3V to +3.6V, T<sub>A</sub> = T<sub>MIN</sub> to T<sub>MAX</sub>, unless otherwise noted. Typical values are at V+ = 3.3V, T<sub>A</sub> = +25°C.) (Note 2)

PARAMETER	SYMBOL	CONDITIONS	MIN	TYP	MAX	UNITS
Crosstalk	V <sub>CT1</sub>	Any switch to any switch R <sub>L</sub> = 100Ω, Figure 3	1MHz < f < 30MHz	-45		dB
	V <sub>CT2</sub>		30MHz < f < 60MHz	-40		
	V <sub>CT3</sub>		60MHz < f < 100MHz	-35		
Differential Crosstalk	V <sub>DCT1</sub>	R <sub>L</sub> = 100Ω, Figure 4	1MHz < f < 30MHz	-60		dB
	V <sub>DCT2</sub>		30MHz < f < 60MHz	-55		
	V <sub>DCT3</sub>		60MHz < f < 100MHz	-50		
<b>SWITCH DYNAMICS</b>						
On-Channel -3dB Bandwidth	BW	R <sub>L</sub> = 100Ω, Differential pair		1000		MHz
Off-Capacitance	C <sub>OFF</sub>	f = 1MHz, _B_ inputs		3.5		pF
On-Capacitance	C <sub>ON</sub>	f = 1MHz, _B_ inputs		6.5		pF
Off-Capacitance, LED Switches	C <sub>OFFLED</sub>	f = 1MHz, _LED inputs		20		pF
On-Capacitance, LED Switches	C <sub>ONLED</sub>	f = 1MHz, _LED inputs		22		pF
Turn-On Time	t <sub>ON</sub>	V <sub>A_</sub> = 1V, Figure 5		25	50	ns
Turn-Off Time	t <sub>OFF</sub>	V <sub>A_</sub> = 1V, Figure 5		20	40	ns
Propagation Delay	t <sub>PLH</sub> , t <sub>PHL</sub>	C <sub>L</sub> = 10pF, Figure 6		0.15		ns
Output Skew Between Ports	t <sub>SK(o)</sub>	Skew between A4 and A5 and any other port, Figure 7		0.01		ns
Output Skew Same Port	t <sub>SK(p)</sub>	Skew between opposite transitions in same port		0.07		ns
<b>SWITCH LOGIC</b>						
Input-Voltage Low	V <sub>IL</sub>				0.8	V
Input-Voltage High	V <sub>IH</sub>		2.0			
Input-Logic Hysteresis	V <sub>HYST</sub>			100		mV
Input Leakage Current	I <sub>SEL</sub>	V+ = 3.6V, V <sub>SEL</sub> = 0 or V+	-5		+5	μA
Operating Supply-Voltage Range	V+		3		3.6	V
Quiescent Supply Current	I+	V+ = 3.6V, V <sub>SEL</sub> = 0 or V+		280	450	μA

**Note 2:** Specifications at -40°C are guaranteed by design.

**Note 3:** Guaranteed by design.

# 10/100/1000 Base-T Ethernet LAN Switch

## Typical Operating Characteristics

( $V_+ = 3.3V$ ,  $T_A = +25^\circ C$ , unless otherwise noted.)

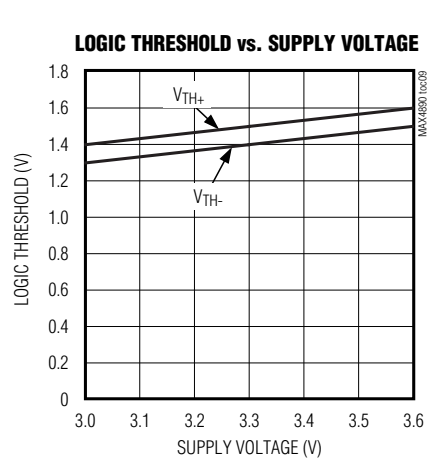
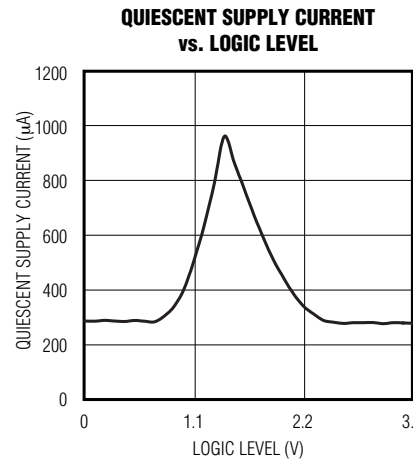
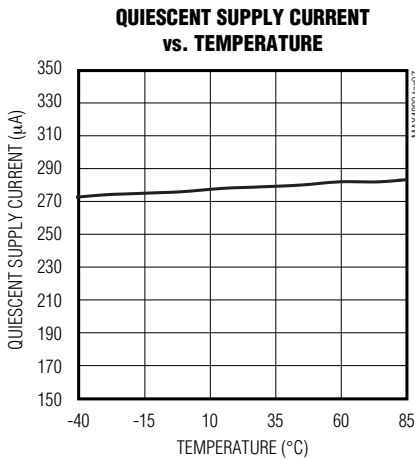
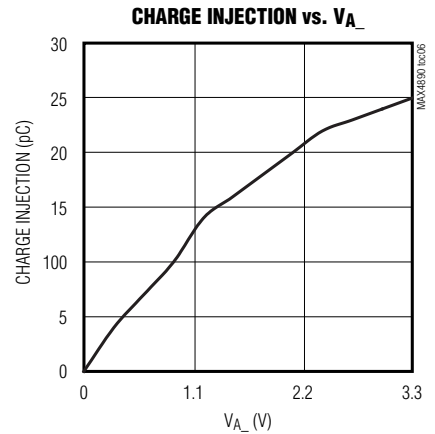
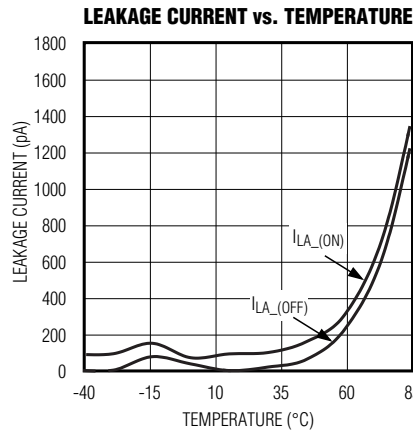
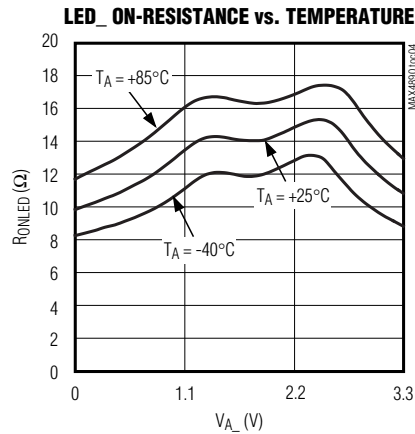
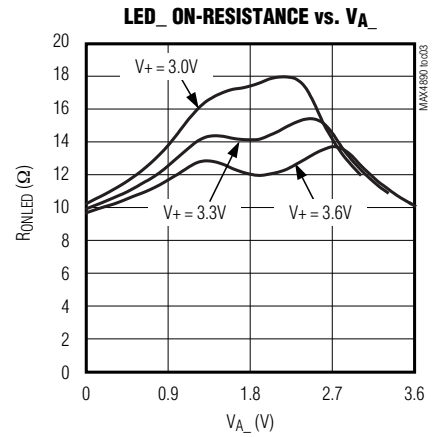
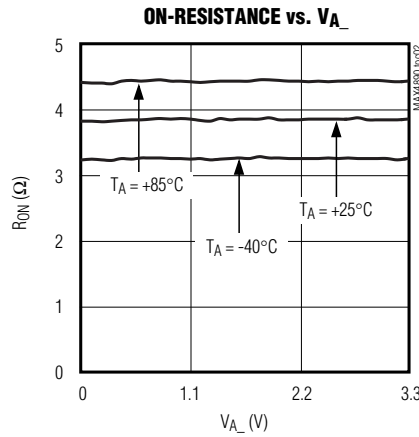
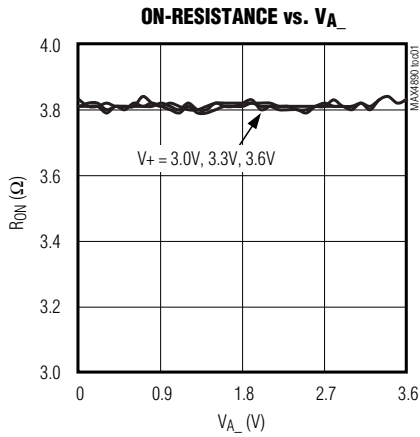

# 10/100/1000 Base-T Ethernet LAN Switch

## Typical Operating Characteristics (continued)

(V+ = 3.3V, T<sub>A</sub> = +25°C, unless otherwise noted.)

MAX4890/MAX4891/MAX4892

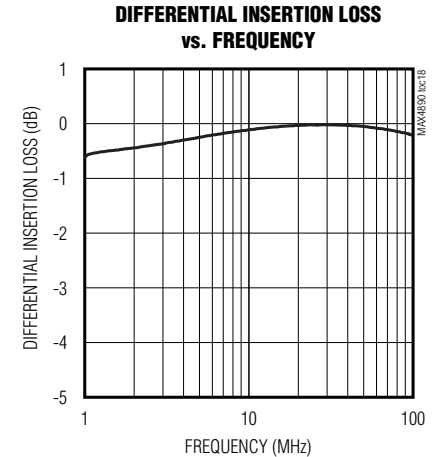
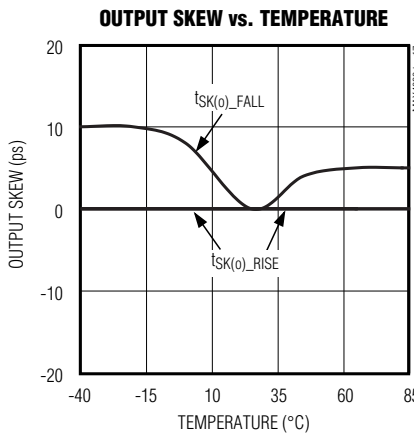
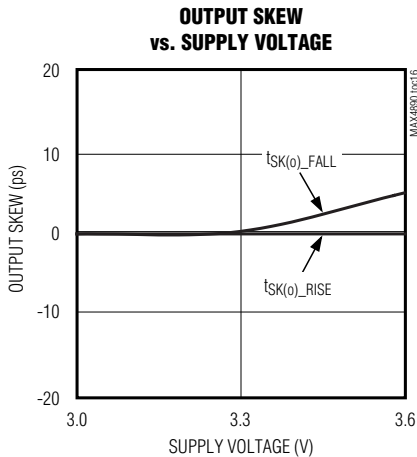
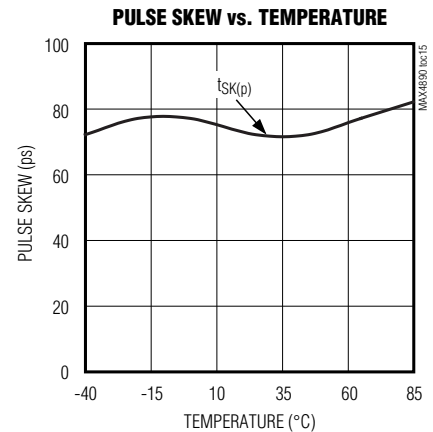
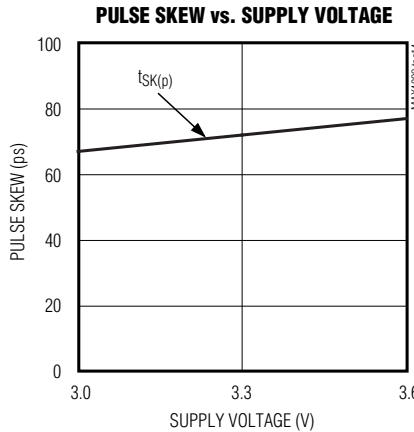
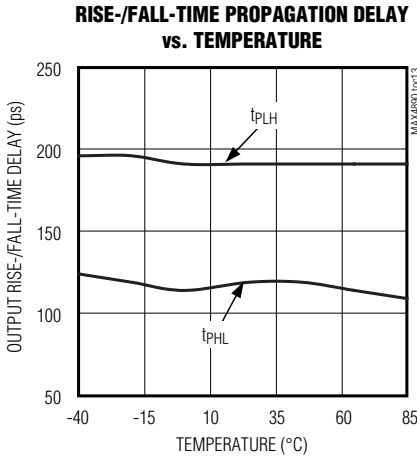
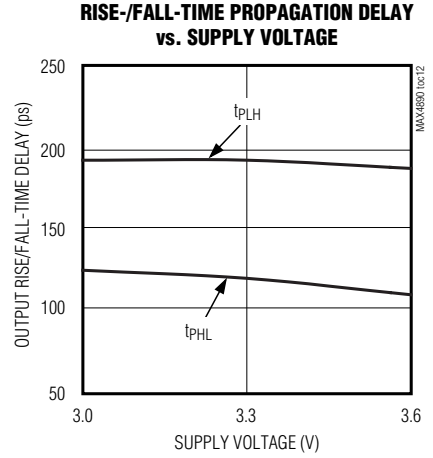
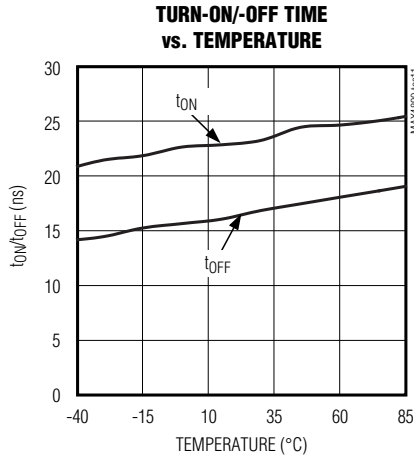
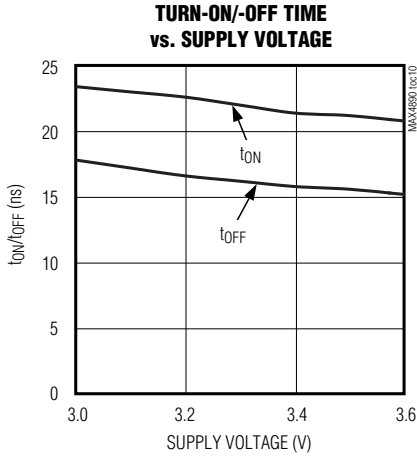

# 10/100/1000 Base-T Ethernet LAN Switch

## Typical Operating Characteristics (continued)

(V+ = 3.3V, T<sub>A</sub> = +25°C, unless otherwise noted.)

**DIFFERENTIAL RETURN LOSS vs. FREQUENCY**

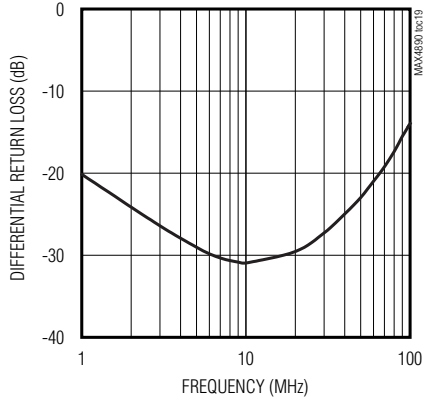

**DIFFERENTIAL CROSSTALK vs. FREQUENCY**

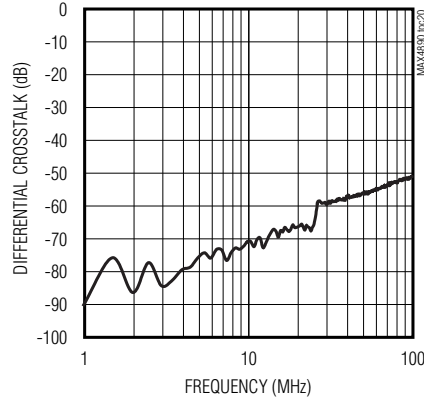

**SINGLE-ENDED OFF-ISOLATION vs. FREQUENCY**

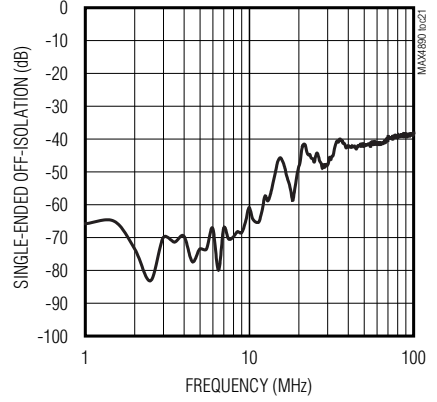

**SINGLE-ENDED CROSSTALK vs. FREQUENCY**

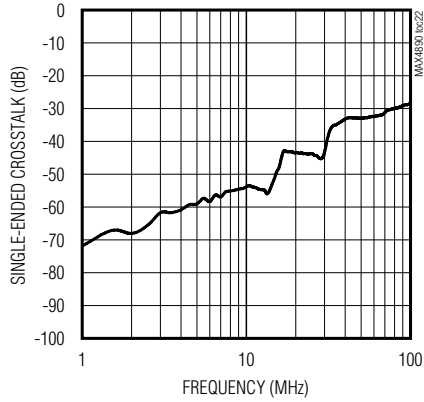

**SINGLE-ENDED INSERTION LOSS vs. FREQUENCY**

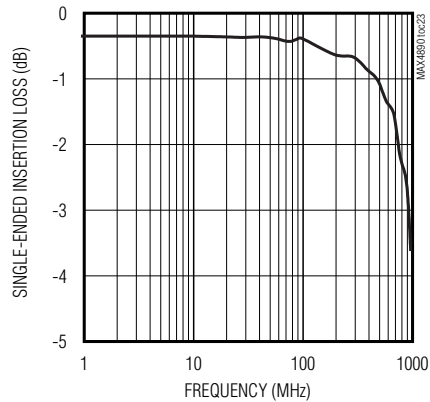

# 10/100/1000 Base-T Ethernet LAN Switch

## Pin Description

PIN			NAME	FUNCTION
MAX4890	MAX4891	MAX4892		
31, 32, 1, 2, 7-10	31, 32, 1, 2, 7-10	36, 1, 2, 3, 7-10	A0-A7	Differential PHY Interface Pair. Connects to the Ethernet PHY.
—	3	4	LED0	LED0 Input
—	4	5	0LED1	0LED1 Output. Connects LED0 to 0LED1 when SEL = 0.
—	5	6	0LED2	0LED2 Output. Connects LED0 to 0LED2 when SEL = 1.
3-6, 12	6, 12	—	N.C.	No Connection. Not internally connected.
11	11	11	GND	Ground
—	—	12	LED1	LED1 Input
—	—	13	1LED1	1LED1 Output. Connects LED1 to 1LED1 when SEL = 0.
—	—	14	1LED2	1LED2 Output. Connects LED1 to 1LED2 when SEL = 1.
13, 14, 17, 18, 21, 22, 25, 26	13, 14, 17, 18, 21, 22, 25, 26	15, 16, 19, 20, 23, 24, 28, 29	7B2-0B2	B2 Differential Transformer Pair
15, 16, 19, 20, 23, 24, 27, 28	15, 16, 19, 20, 23, 24, 27, 28	17, 18, 21, 22, 25, 26, 30, 31	7B1-0B1	B1 Differential Transformer Pair
29	29	27	SEL	Select Input. Selects switch connection. See the Truth Table (Table 1).
—	—	32	2LED2	2LED2 Output. Connects LED2 to 2LED2 when SEL = 1.
—	—	33	2LED1	2LED1 Output. Connects LED2 to 2LED1 when SEL = 0.
—	—	34	LED2	LED2 Input
30	30	35	V+	Positive Supply-Voltage Input
—	—	—	EP	Exposed Paddle. Not internally connected. Leave EP unconnected or connect to ground.

MAX4890/MAX4891/MAX4892

# 10/100/1000 Base-T Ethernet LAN Switch

## Test Circuits

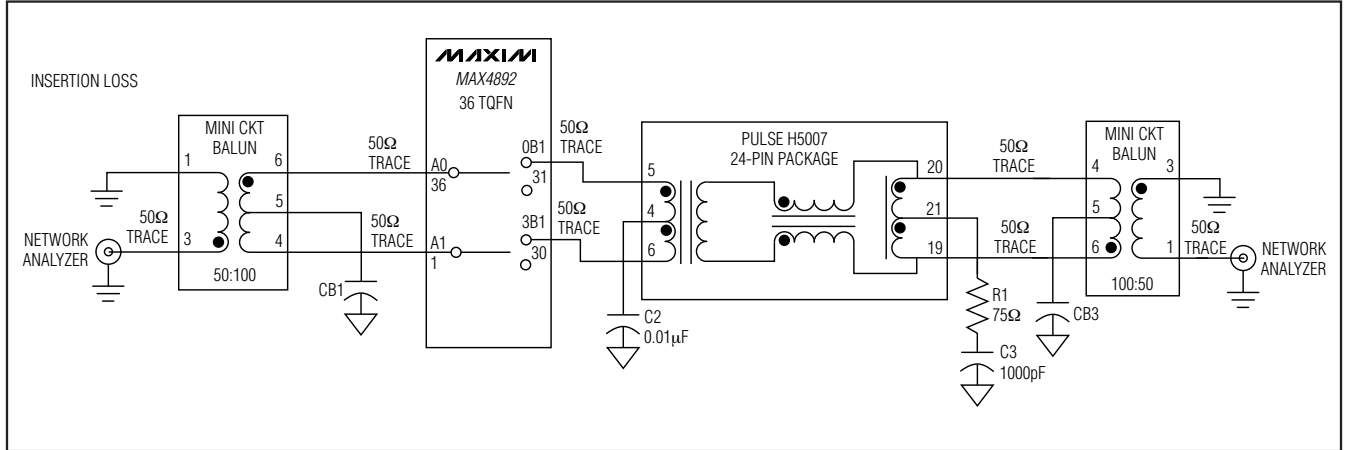

Figure 1. Differential Insertion Loss

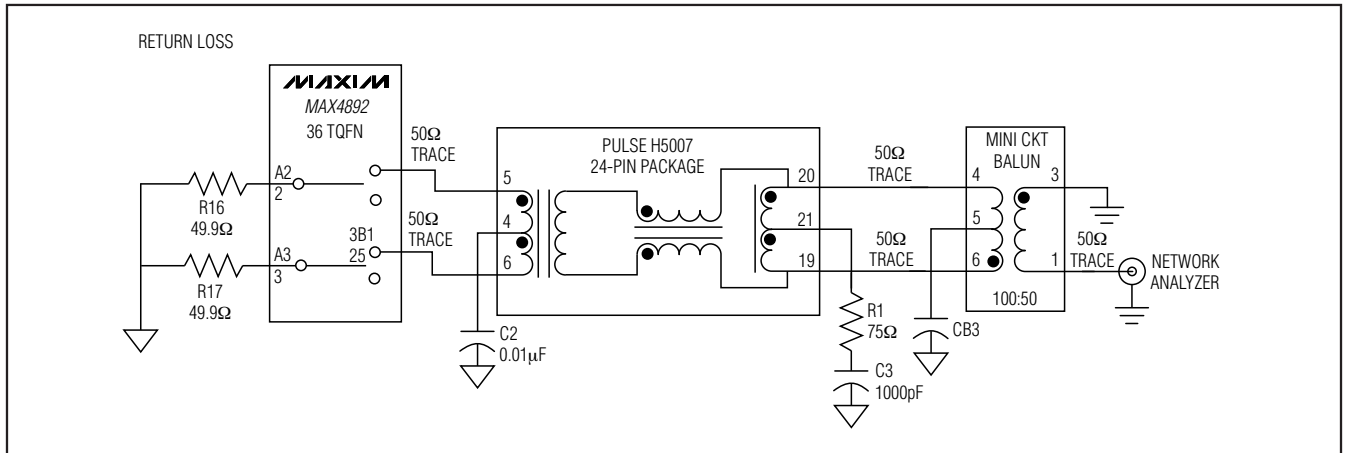

Figure 2. Differential Return Loss



# 10/100/1000 Base-T Ethernet LAN Switch

## Test Circuits (continued)

MAX4890/MAX4891/MAX4892

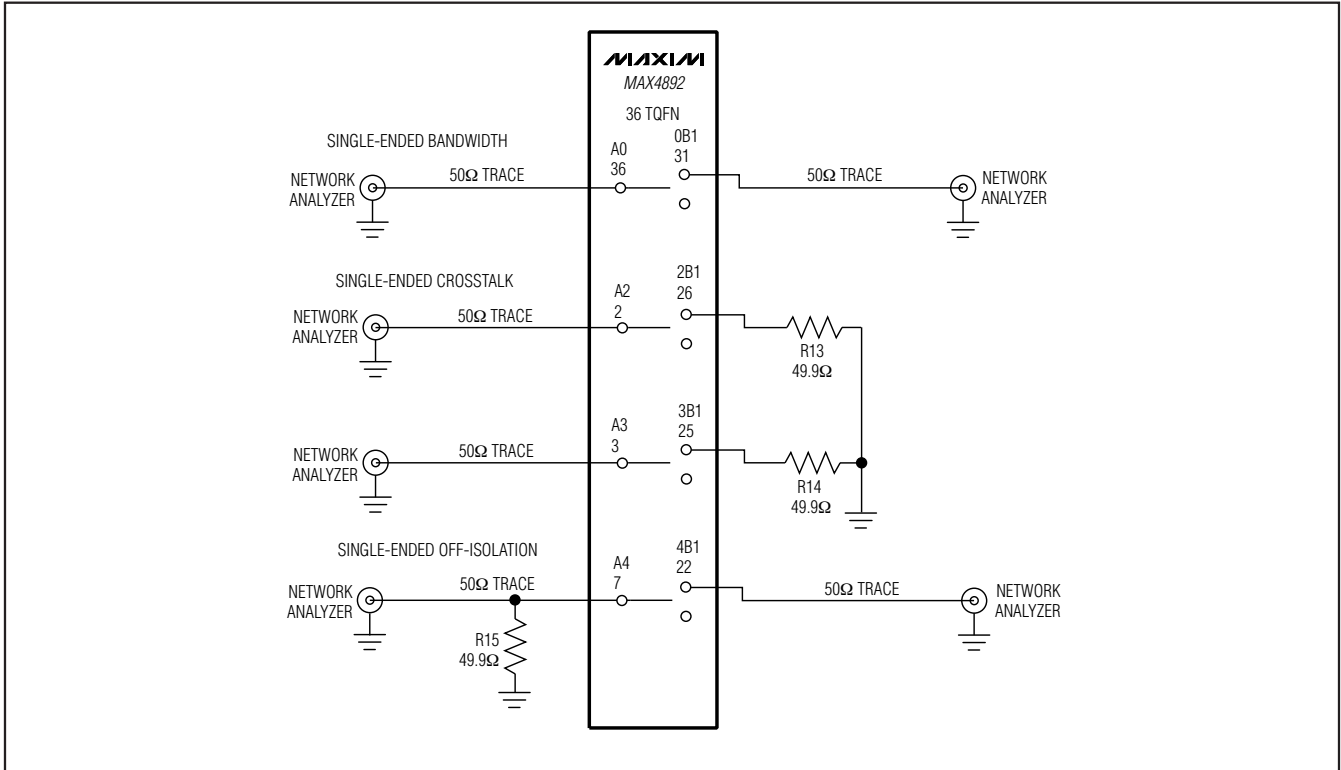

Figure 3. Single-Ended Bandwidth, Crosstalk and Off-Isolation

### Detailed Description

The MAX4890/MAX4891/MAX4892 are high-speed analog switches targeted for 10/100/1000 Base-T applications. In a typical application, the MAX4890/MAX4891/MAX4892 switch the signals from two separate interface transformers and connect the signals to a single 10/100/1000 Base-T Ethernet PHY (see the *Typical Operating Circuit*). This configuration simplifies docking station design by avoiding signal reflections associated with unterminated transmission lines in a T configuration. The MAX4891 and MAX4892 also include LED switches that allow the LED output signals to be routed to a docking station along with the Ethernet signals. See the *Functional Diagrams*.

The MAX4890/MAX4891/MAX4892 switches provide an extremely low capacitance and on-resistance to meet Ethernet insertion and return-loss specifications. The MAX4891/MAX4892 feature one and three built-in LED switches, respectively.

The MAX4890/MAX4891/MAX4892 incorporate a unique architecture design utilizing only n-channel switches

within the main Ethernet switch, reducing I/O capacitance and channel resistance. An internal two-stage charge pump with a nominal output of 7.5V provides the high voltage needed to drive the gates of the n-channel switches, while maintaining a consistently low  $R_{ON}$  throughout the input signal range. An internal bandgap reference set to 1.23V and an internal oscillator running at 2.5MHz provide proper charge-pump operation. Unlike other charge-pump circuits, the MAX4890/MAX4891/MAX4892 include internal flyback capacitors, reducing design time, board space, and cost.

### Digital Control Inputs

The MAX4890/MAX4891/MAX4892 provide a single digital control SEL. SEL controls the switches as well as the LED switches as shown in Table 1.

Table 1. Truth Table

SEL	CONNECTION
0	A_ to _B1, LED_ to _LED1
1	A_ to _B2, LED_ to _LED2

# 10/100/1000 Base-T Ethernet LAN Switch

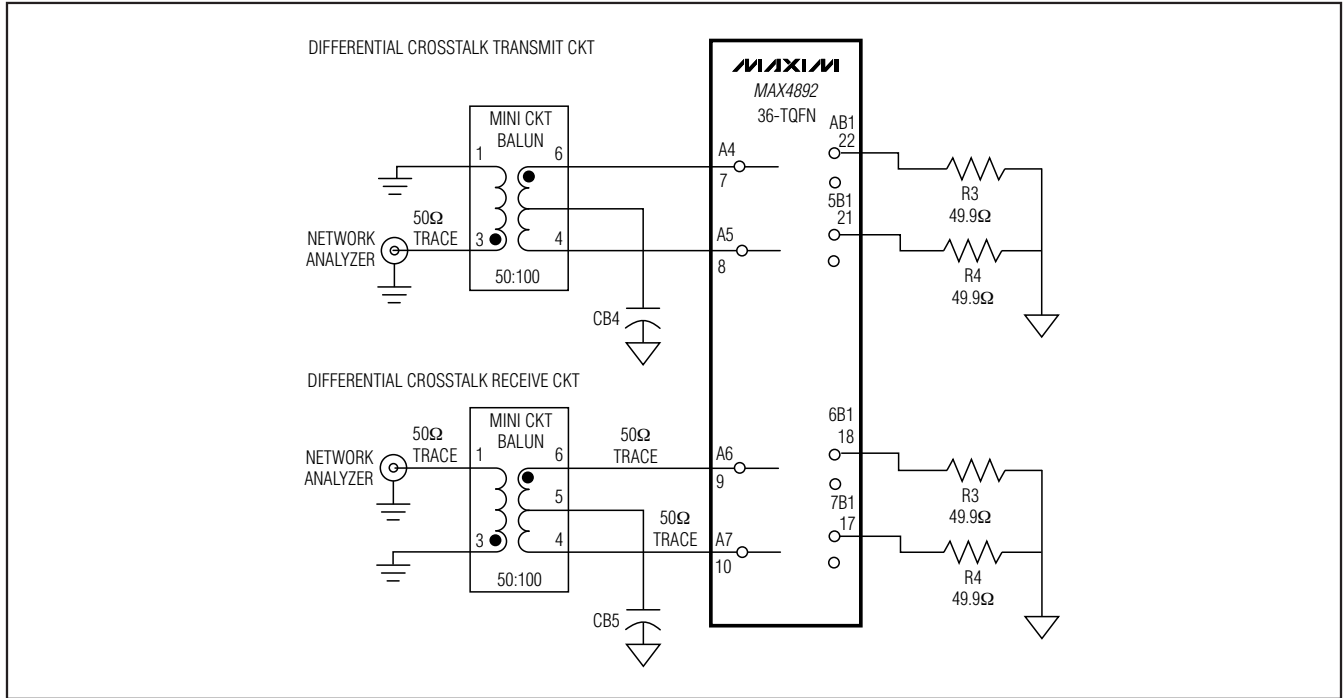

Figure 4. Differential Crosstalk

### Analog Signal Levels

The on-resistance of the MAX4890/MAX4891/MAX4892 is very low and stable as the analog input signals are swept from ground to  $V+$  (see the *Typical Operating Characteristics*). The switches are bidirectional, allowing  $A\_$  and  $B\_$  to be configured as either inputs or outputs.

### ESD Protection

The MAX4890/MAX4891/MAX4892 are characterized using the Human Body Model for  $\pm 2kV$  of ESD protection. Figure 8 shows the Human Body Model, and Figure 9 shows the current waveform the Human Body Model generates when discharged into a low-impedance load. This model consists of a 100pF capacitor charged to the ESD voltage of interest, which is then discharged into the test device through a 1.5k $\Omega$  resistor.

### Applications Information

#### Typical Operating Circuit

The *Typical Operating Circuit* depicts the MAX4890/MAX4891/MAX4892 in a 10/100/1000 Base-T docking station application.

### Line-Card Redundancy (Ethernet T3/E3)

Figure 10 shows the MAX4890/MAX4891/MAX4892 in a line-card redundancy configuration.

### Power-Supply Sequencing and Overvoltage Protection

**Caution:** Do not exceed the absolute maximum ratings. Stresses beyond the listed ratings may cause permanent damage to the device.

Proper power-supply sequencing is recommended for all CMOS devices. Always apply  $V+$  before applying analog signals, especially if the analog signal is not current limited.

### Layout

High-speed switches require proper layout and design procedures for optimum performance. Keep design-controlled-impedance printed circuit board traces as short as possible. Ensure that bypass capacitors are as close to the device as possible. Use large ground planes where possible.

# 10/100/1000 Base-T Ethernet LAN Switch

MAX4890/MAX4891/MAX4892

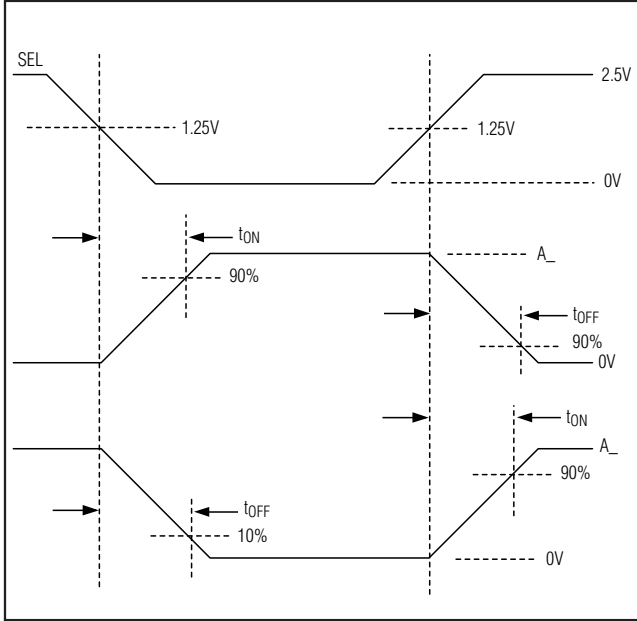

Figure 5. ENABLE and DISABLE Times

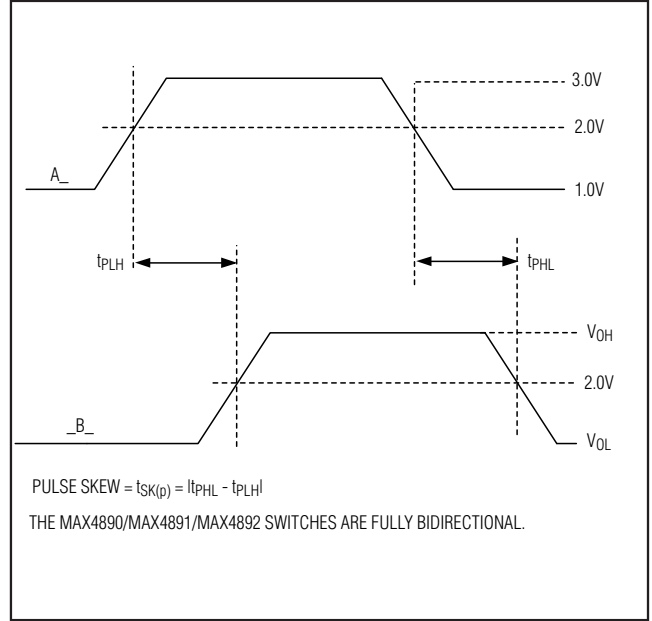

Figure 6. Propagation Delay Times

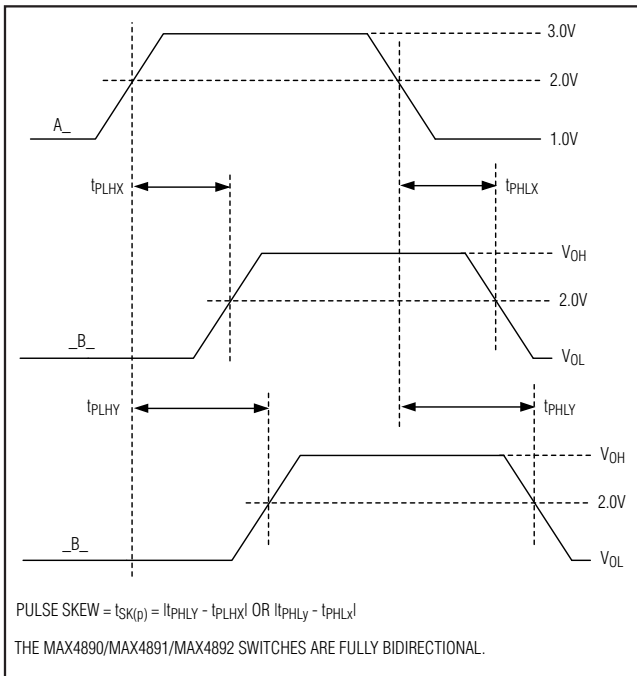

Figure 7. Output Skew

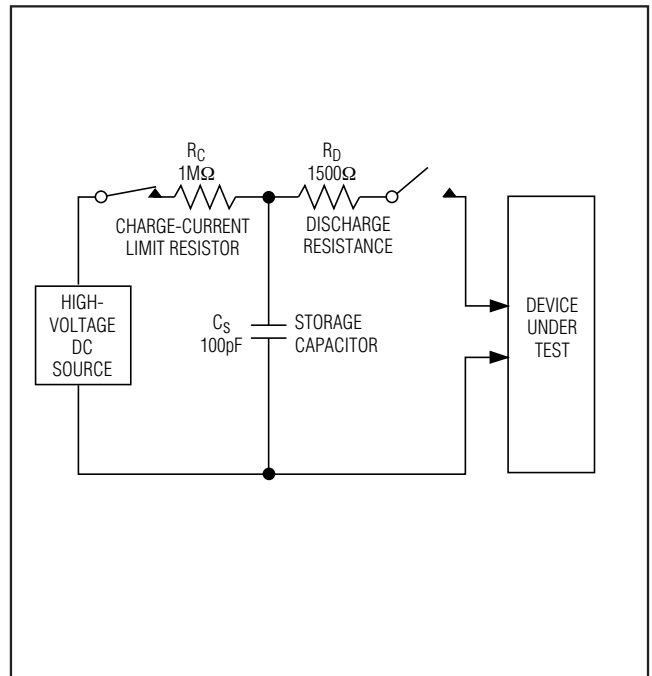

Figure 8. Human Body ESD Test Model

# 10/100/1000 Base-T Ethernet LAN Switch

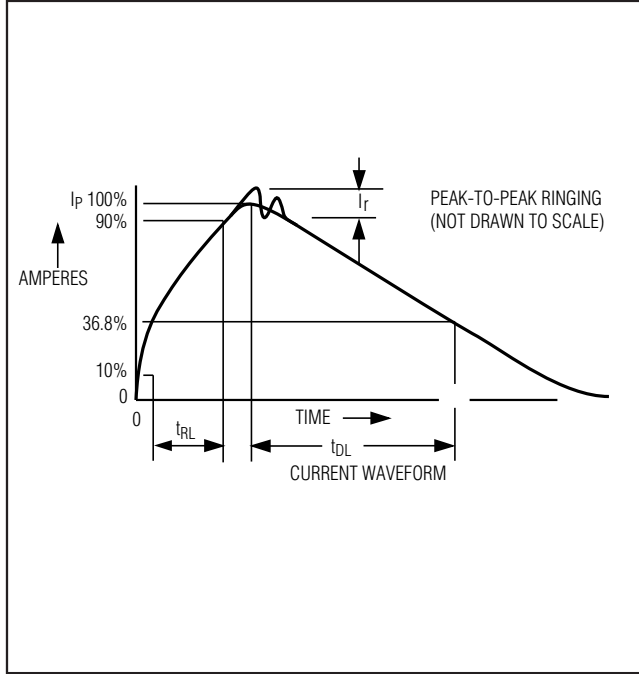

Figure 9. Human Body Model Current Waveform

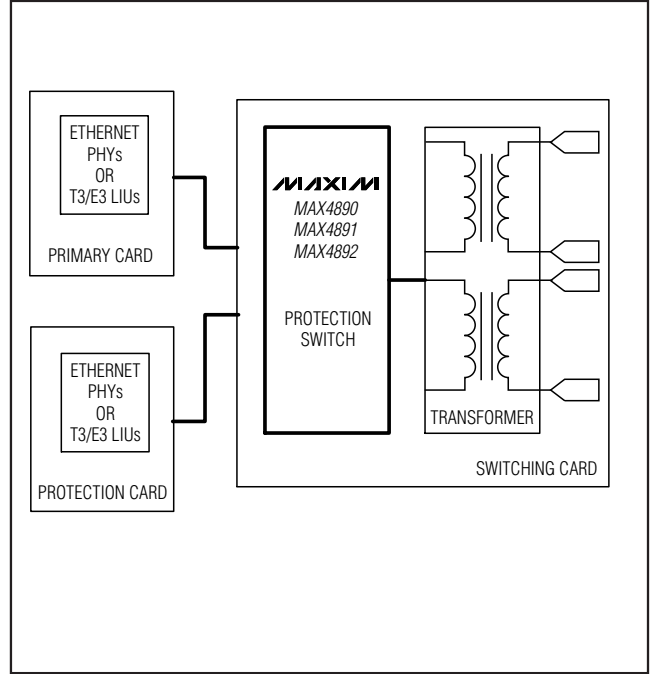
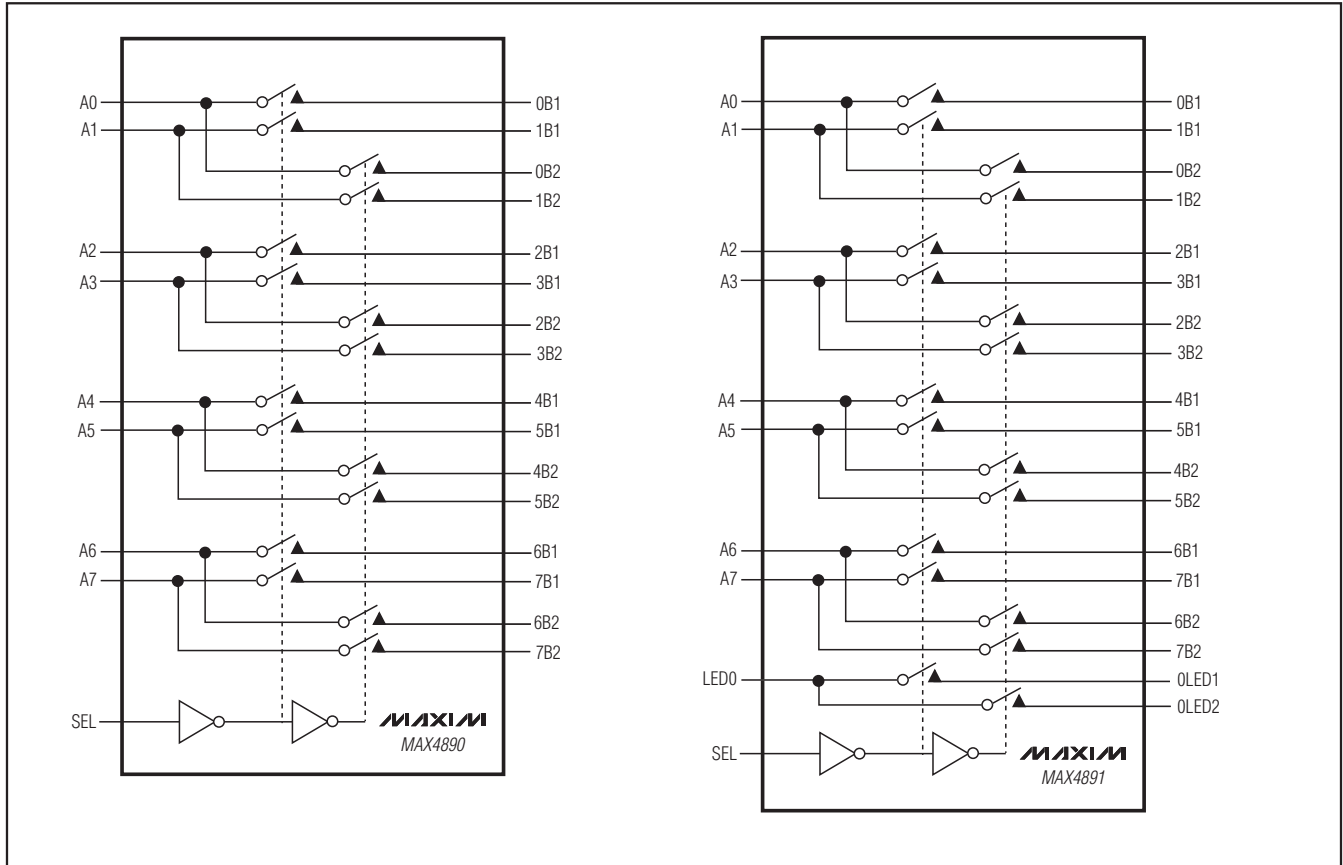

Figure 10. Typical Application for Line-Card Redundancy



# 10/100/1000 Base-T Ethernet LAN Switch

## Functional Diagrams



# 10/100/1000 Base-T Ethernet LAN Switch

## Functional Diagrams (continued)

MAX4890/MAX4891/MAX4892

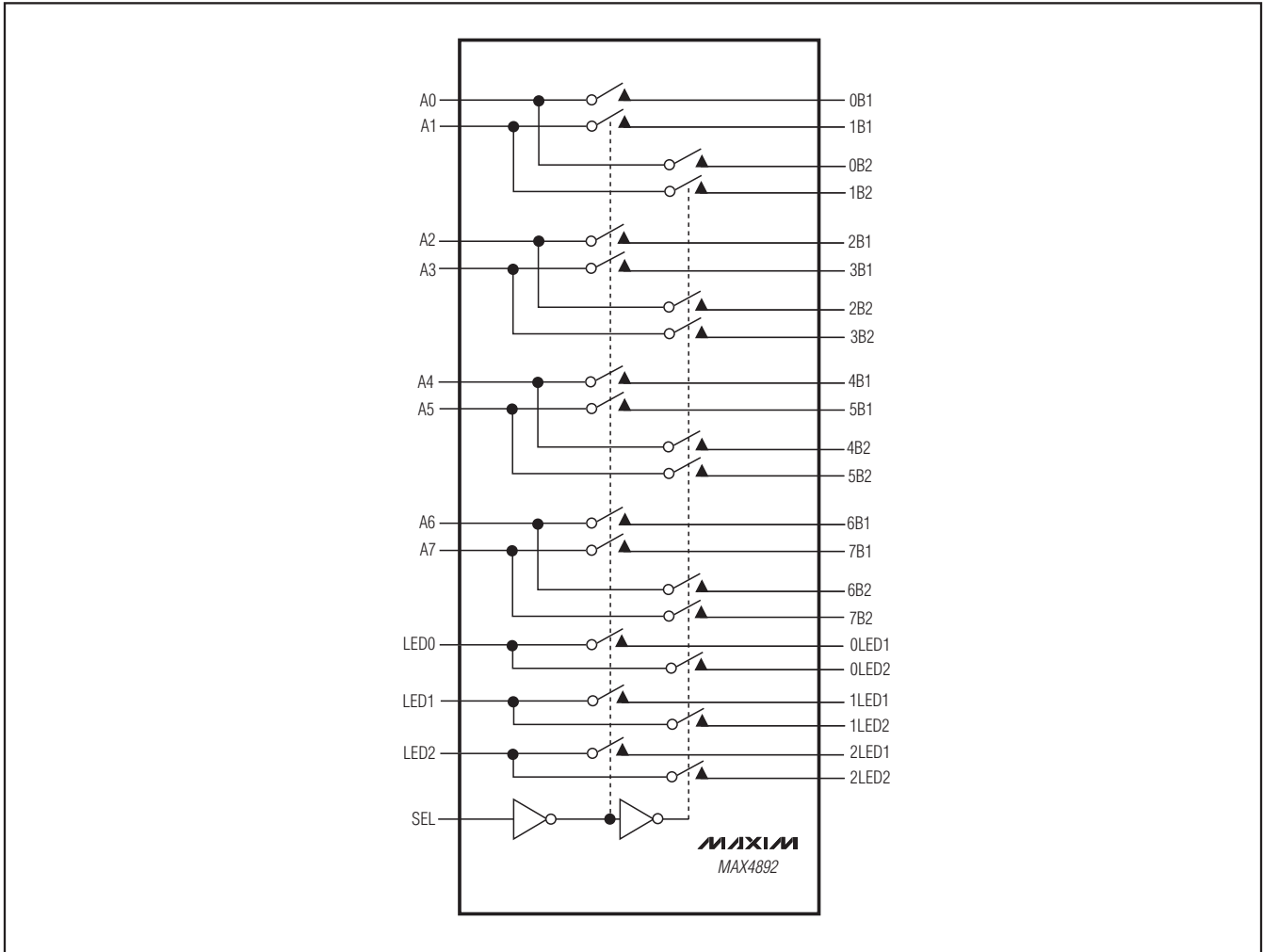

# 10/100/1000 Base-T Ethernet LAN Switch

## Pin Configurations (continued)

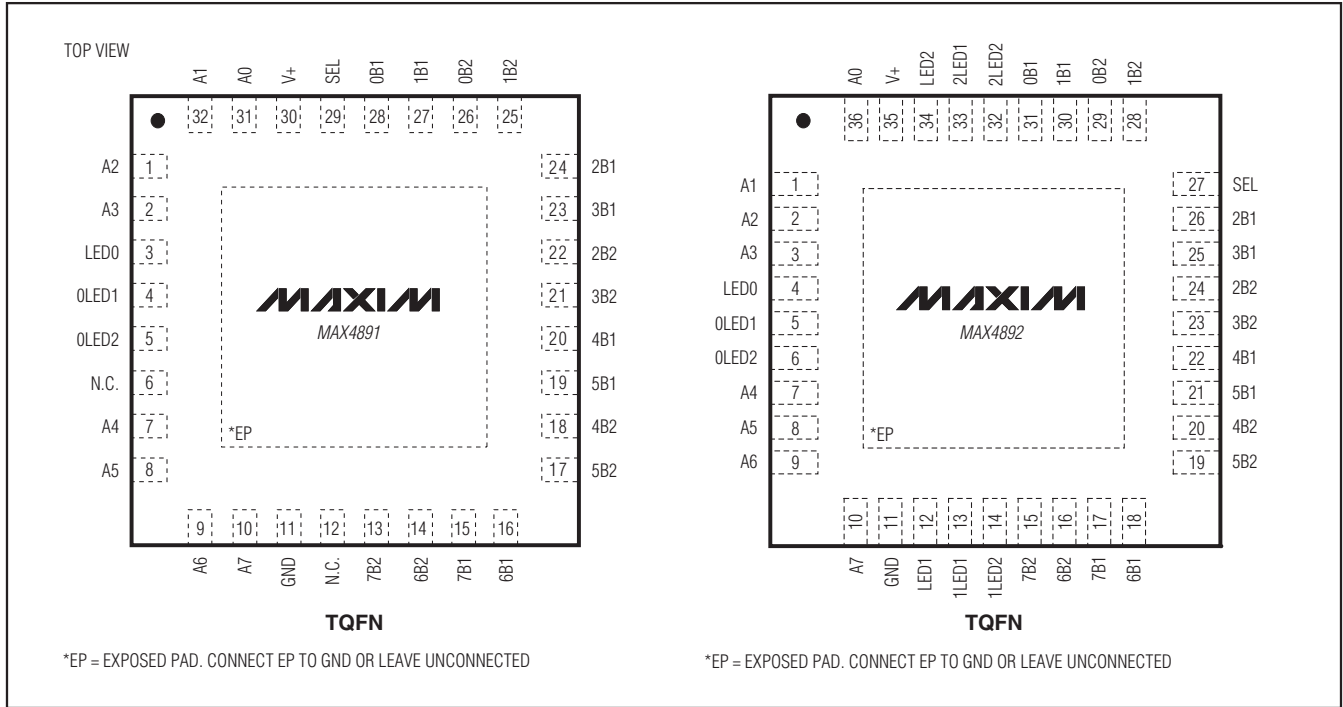

### Chip Information

PROCESS: BiCMOS

### Package Information

For the latest package outline information and land patterns, go to [www.maxim-ic.com/packages](http://www.maxim-ic.com/packages).

PACKAGE TYPE	PACKAGE CODE	DOCUMENT NO.
32 TQFN-EP	T-3255-4	<a href="#">21-0140</a>
36 TQFN-EP	T-3666-3	<a href="#">21-0141</a>



# 10/100/1000 Base-T Ethernet LAN Switch

## Revision History

REVISION NUMBER	REVISION DATE	DESCRIPTION	PAGES CHANGED
1	8/05	Removed future product part number	—
2	8/07	Added exposed pad information	1, 7, 14, 15, 16

MAX4890/MAX4891/MAX4892

Maxim cannot assume responsibility for use of any circuitry other than circuitry entirely embodied in a Maxim product. No circuit patent licenses are implied. Maxim reserves the right to change the circuitry and specifications without notice at any time.

Maxim Integrated Products, 120 San Gabriel Drive, Sunnyvale, CA 94086 408-737-7600 \_\_\_\_\_ 17