



Is Now Part of



ON Semiconductor®

To learn more about ON Semiconductor, please visit our website at
www.onsemi.com

Please note: As part of the Fairchild Semiconductor integration, some of the Fairchild orderable part numbers will need to change in order to meet ON Semiconductor's system requirements. Since the ON Semiconductor product management systems do not have the ability to manage part nomenclature that utilizes an underscore (_), the underscore (_) in the Fairchild part numbers will be changed to a dash (-). This document may contain device numbers with an underscore (_). Please check the ON Semiconductor website to verify the updated device numbers. The most current and up-to-date ordering information can be found at www.onsemi.com. Please email any questions regarding the system integration to Fairchild_questions@onsemi.com.

ON Semiconductor and the ON Semiconductor logo are trademarks of Semiconductor Components Industries, LLC dba ON Semiconductor or its subsidiaries in the United States and/or other countries. ON Semiconductor owns the rights to a number of patents, trademarks, copyrights, trade secrets, and other intellectual property. A listing of ON Semiconductor's product/patent coverage may be accessed at www.onsemi.com/site/pdf/Patent-Marking.pdf. ON Semiconductor reserves the right to make changes without further notice to any products herein. ON Semiconductor makes no warranty, representation or guarantee regarding the suitability of its products for any particular purpose, nor does ON Semiconductor assume any liability arising out of the application or use of any product or circuit, and specifically disclaims any and all liability, including without limitation special, consequential or incidental damages. Buyer is responsible for its products and applications using ON Semiconductor products, including compliance with all laws, regulations and safety requirements or standards, regardless of any support or applications information provided by ON Semiconductor. "Typical" parameters which may be provided in ON Semiconductor data sheets and/or specifications can and do vary in different applications and actual performance may vary over time. All operating parameters, including "Typicals" must be validated for each customer application by customer's technical experts. ON Semiconductor does not convey any license under its patent rights nor the rights of others. ON Semiconductor products are not designed, intended, or authorized for use as a critical component in life support systems or any FDA Class 3 medical devices or medical devices with a same or similar classification in a foreign jurisdiction or any devices intended for implantation in the human body. Should Buyer purchase or use ON Semiconductor products for any such unintended or unauthorized application, Buyer shall indemnify and hold ON Semiconductor and its officers, employees, subsidiaries, affiliates, and distributors harmless against all claims, costs, damages, and expenses, and reasonable attorney fees arising out of, directly or indirectly, any claim of personal injury or death associated with such unintended or unauthorized use, even if such claim alleges that ON Semiconductor was negligent regarding the design or manufacture of the part. ON Semiconductor is an Equal Opportunity/Affirmative Action Employer. This literature is subject to all applicable copyright laws and is not for resale in any manner.



January 2016

RS1JFP - RS1MFP Surface Mount Fast Recovery Rectifiers

Features

- Low Power Loss, High Efficiency
 - Larger Cathode Pad for Improved Power Dissipation
 - Ultra Thin Profile - Package Height <1.0 mm
 - High Surge Capacity
 - Low Forward Voltage: 1.3 V Maximum
 - UL Flammability 94V-0 Classification
 - MSL 1 per J-STD-020
 - RoHS Compliant / Green Molding Compound
 - Industrial Device Qualified per AEC-Q101 Standards
- * See authorized use policy

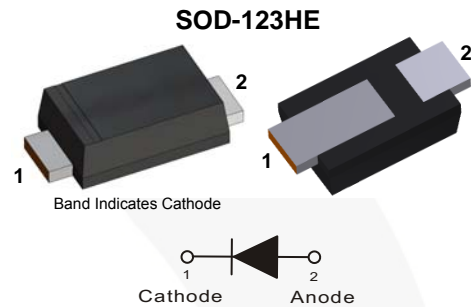

Ordering Information

Part Number	Top Mark	Package	Packing Method
RS1JFP	JLS	SOD-123HE	Tape and Reel
RS1KFP	KLS	SOD-123HE	Tape and Reel
RS1MFP	MLS	SOD-123HE	Tape and Reel

Absolute Maximum Ratings

Stresses exceeding the absolute maximum ratings may damage the device. The device may not function or be operable above the recommended operating conditions and stressing the parts to these levels is not recommended. In addition, extended exposure to stresses above the recommended operating conditions may affect device reliability. The absolute maximum ratings are stress ratings only. Values are at $T_A = 25^\circ\text{C}$ unless otherwise noted.

Symbol	Parameter	Value			Unit
		RS1JFP	RS1KFP	RS1MFP	
V_{RRM}	Repetitive Peak Reverse Voltage	600	800	1000	V
V_{RMS}	RMS Reverse Voltage	420	560	700	V
V_R	DC Blocking Voltage	600	800	1000	V
$I_{F(AV)}$	Average Forward Rectified Current	1.2			A
I_{FSM}	Peak Forward Surge Current: 8.3 ms Single Half Sine-Wave Superimposed on Rated Load	50			A
T_J	Operating Junction Temperature Range	-55 to +150			$^\circ\text{C}$
T_{STG}	Storage Temperature Range	-55 to +150			$^\circ\text{C}$

Thermal Characteristics⁽¹⁾

Values are at $T_A = 25^\circ\text{C}$ unless otherwise noted.

Symbol	Parameter	Value	Unit
Ψ_{JL}	Typical Thermal Characteristics, Junction-to-Lead ⁽²⁾	12	$^\circ\text{C}/\text{W}$
$R_{\theta JA}$	Typical Thermal Resistance, Junction-to-Ambient	140	$^\circ\text{C}/\text{W}$

Notes:

1. Per JESD51-3 recommended thermal test board. Device mounted on FR-4 PCB, board size = 76.2 mm x 114.3 mm.
2. Thermocouple soldered at cathode lead.

Electrical Characteristics

Values are at $T_A = 25^\circ\text{C}$ unless otherwise noted.

Symbol	Parameter	Conditions	Min.	Typ.	Max.	Unit
V_F	Instantaneous Forward Voltage ⁽³⁾	$I_F = 1.2\text{ A}$			1.3	V
I_R	Reverse Current at Rated V_R	$T_J = 25^\circ\text{C}$			5	μA
		$T_J = 125^\circ\text{C}$			150	
C_J	Junction Capacitance	$V_R = 0\text{ V}, f = 1\text{ MHz}$		18		pF
T_{rr}	Reverse Recovery Time	$I_F = 0.5\text{ A}, I_R = 1\text{ A}, I_{rr} = 0.25\text{ A}$			300	ns

Note:

3. Pulse test with $PW = 300\ \mu\text{s}$, 1% duty cycle

Typical Performance Characteristics

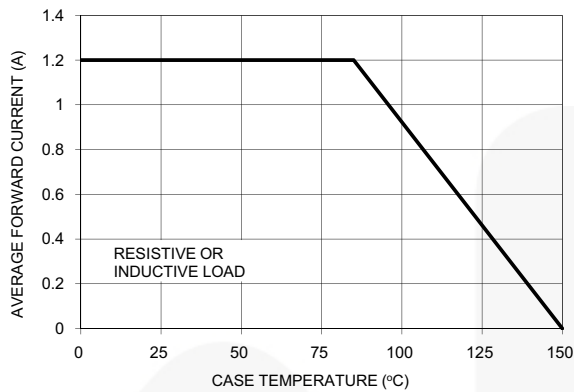

Figure 1. Maximum Forward Current Derating Voltage

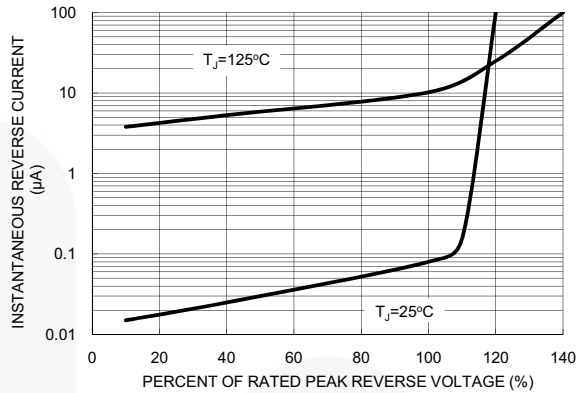

Figure 2. Typical Reverse Characteristics

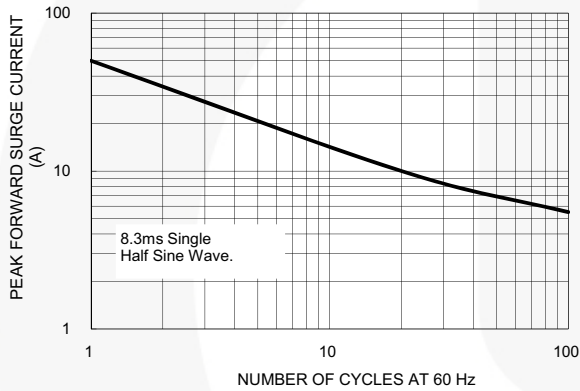

Figure 3. Maximum Non-Repetitive Forward Surge Current

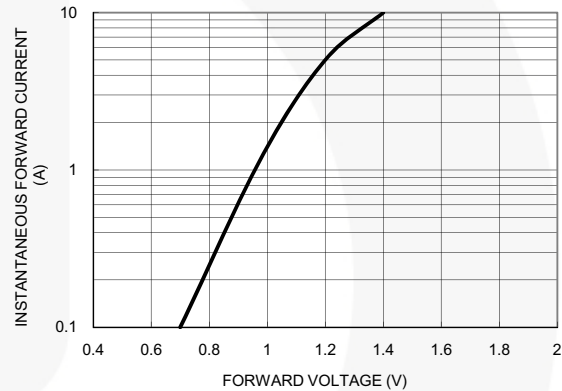

Figure 4. Typical Instantaneous Forward Characteristics

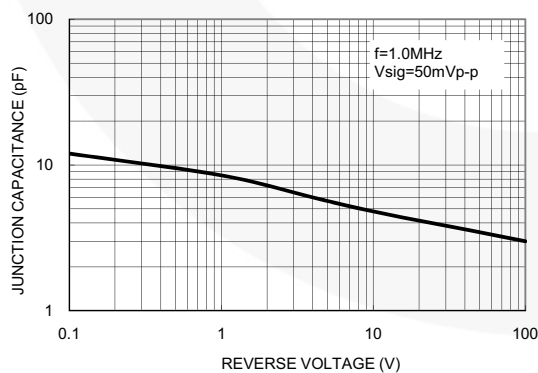

Figure 5. Typical Junction Capacitance

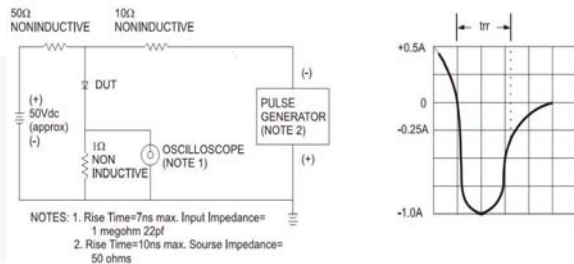
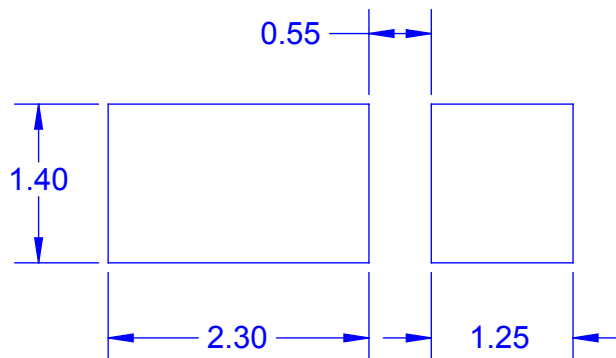
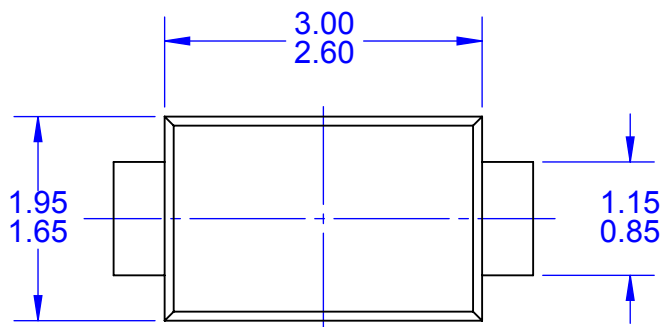
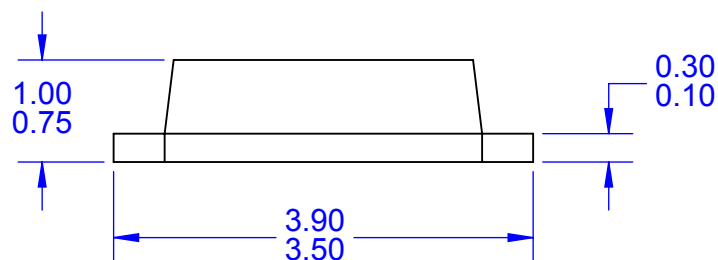

Figure 6. Reverse Recovery Time Characteristic and Test Circuit Diagram



LAND PATTERN RECOMMENDATION



NOTES:

- A. NO INDUSTRY STANDARD APPLIES TO THIS PACKAGE.
- B. ALL DIMENSIONS ARE IN MILLIMETERS.
- C. DIMENSIONS ARE EXCLUSIVE OF BURRS, MOLD FLASH AND TIE BAR PROTRUSIONS.
- D. DRAWING FILE NAME: MKT-MA02Crev2

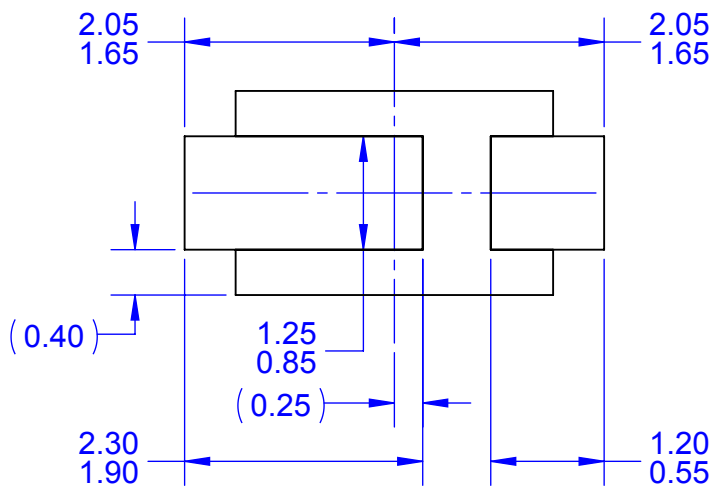

ON Semiconductor and  are trademarks of Semiconductor Components Industries, LLC dba ON Semiconductor or its subsidiaries in the United States and/or other countries. ON Semiconductor owns the rights to a number of patents, trademarks, copyrights, trade secrets, and other intellectual property. A listing of ON Semiconductor's product/patent coverage may be accessed at www.onsemi.com/site/pdf/Patent-Marking.pdf. ON Semiconductor reserves the right to make changes without further notice to any products herein. ON Semiconductor makes no warranty, representation or guarantee regarding the suitability of its products for any particular purpose, nor does ON Semiconductor assume any liability arising out of the application or use of any product or circuit, and specifically disclaims any and all liability, including without limitation special, consequential or incidental damages. Buyer is responsible for its products and applications using ON Semiconductor products, including compliance with all laws, regulations and safety requirements or standards, regardless of any support or applications information provided by ON Semiconductor. "Typical" parameters which may be provided in ON Semiconductor data sheets and/or specifications can and do vary in different applications and actual performance may vary over time. All operating parameters, including "Typicals" must be validated for each customer application by customer's technical experts. ON Semiconductor does not convey any license under its patent rights nor the rights of others. ON Semiconductor products are not designed, intended, or authorized for use as a critical component in life support systems or any FDA Class 3 medical devices or medical devices with a same or similar classification in a foreign jurisdiction or any devices intended for implantation in the human body. Should Buyer purchase or use ON Semiconductor products for any such unintended or unauthorized application, Buyer shall indemnify and hold ON Semiconductor and its officers, employees, subsidiaries, affiliates, and distributors harmless against all claims, costs, damages, and expenses, and reasonable attorney fees arising out of, directly or indirectly, any claim of personal injury or death associated with such unintended or unauthorized use, even if such claim alleges that ON Semiconductor was negligent regarding the design or manufacture of the part. ON Semiconductor is an Equal Opportunity/Affirmative Action Employer. This literature is subject to all applicable copyright laws and is not for resale in any manner.

PUBLICATION ORDERING INFORMATION

LITERATURE FULFILLMENT:

Literature Distribution Center for ON Semiconductor
19521 E. 32nd Pkwy, Aurora, Colorado 80011 USA
Phone: 303-675-2175 or 800-344-3860 Toll Free USA/Canada
Fax: 303-675-2176 or 800-344-3867 Toll Free USA/Canada
Email: orderlit@onsemi.com

N. American Technical Support: 800-282-9855 Toll Free
USA/Canada
Europe, Middle East and Africa Technical Support:
Phone: 421 33 790 2910
Japan Customer Focus Center
Phone: 81-3-5817-1050

ON Semiconductor Website: www.onsemi.com
Order Literature: <http://www.onsemi.com/orderlit>
For additional information, please contact your local
Sales Representative