

Agilent AT-30511, AT-30533 Low Current, High Performance NPN Silicon Bipolar Transistors

Data Sheet

Description

Agilent's AT-30511 and AT-30533 are high performance NPN bipolar transistors that have been optimized for maximum f_T at low voltage operation, making them ideal for use in battery powered applications in wireless markets. The AT-30533 uses the 3 lead SOT-23, while the AT-30511 places the same die in the higher performance 4 lead SOT-143. Both packages are industry standard, and compatible with high volume surface mount assembly techniques.

The 3.2 micron emitter-to-emitter pitch and reduced parasitic design of these transistors yields extremely high performance products that can perform a multiplicity of tasks. The 5 emitter finger interdigitated geometry yields an extremely fast transistor with high gain and low operating currents.

Optimized performance at 2.7 V makes these devices ideal for use in 900 MHz, 1.8 GHz, and 2.4 GHz battery operated systems as an LNA, gain stage, buffer, oscillator, or active mixer. Typical amplifier designs at 900 MHz yield 1.3 dB noise figures with 13 dB or more associated gain at a 2.7 V, 1 mA

Outline Drawing

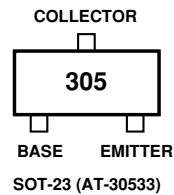
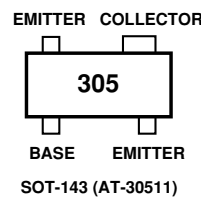

bias. Voltage breakdowns are high enough for use at 5 volts. High gain capability at 1 V, 1 mA makes these devices a good fit for 900 MHz pager applications.

The AT-3 series bipolar transistors are fabricated using an optimized version of Agilent's 10 GHz f_T , 30 GHz f_{MAX} Self-Aligned-Transistor (SAT) process. The die are nitride passivated for surface protection. Excellent device uniformity, performance and reliability are produced by the use of ion-implantation, self-alignment techniques, and gold metalization in the fabrication of these devices.

Features

- High Performance Bipolar Transistor Optimized for Low Current, Low Voltage Operation
- 900 MHz Performance:
AT-30511: 1.1 dB NF, 16 dB G_A
AT-30533: 1.1 dB NF, 13 dB G_A
- Characterized for End-Of-Life Battery Use (2.7 V)
- SOT-23 and SOT-143 SMT Plastic Packages
- Tape-And-Reel Packaging Option Available
- Lead-free Option Available



AT-30511, AT-30533 Absolute Maximum Ratings

Symbol	Parameter	Units	Absolute Maximum ^[1]
V_{EBO}	Emitter-Base Voltage	V	1.5
V_{CBO}	Collector-Base Voltage	V	11
V_{CEO}	Collector-Emitter Voltage	V	5.5
I_C	Collector Current	mA	8
P_T	Power Dissipation ^{[2] [3]}	mW	100
T_j	Junction Temperature	°C	150
T_{STG}	Storage Temperature	°C	-65 to 150

Thermal Resistance^[2]:

$$\theta_{jc} = 550^\circ\text{C/W}$$

Notes:

1. Operation of this device above any one of these parameters may cause permanent damage.
2. $T_{\text{Mounting Surface}} = 25^\circ\text{C}$.
3. Derate at 1.82 mW/°C for $T_C > 95^\circ\text{C}$.

Electrical Specifications, $T_A = 25^\circ\text{C}$

Symbol	Parameters and Test Conditions	Units	AT-30511			AT-30533		
			Min	Typ	Max	Min	Typ	Max
NF	Noise Figure $V_{CE} = 2.7\text{ V}, I_C = 1\text{ mA}$ $f = 0.9\text{ GHz}$	dB		1.1 ^[1]	1.4 ^[1]		1.1 ^[2]	1.4 ^[2]
G_A	Associated Gain $V_{CE} = 2.7\text{ V}, I_C = 1\text{ mA}$ $f = 0.9\text{ GHz}$	dB	14 ^[1]	16 ^[1]		11 ^[2]	13 ^[2]	
h_{FE}	Forward Current Transfer Ratio $V_{CE} = 2.7\text{ V}$ $I_C = 1\text{ mA}$	-	70		300	70		300
I_{CBO}	Collector Cutoff Current $V_{CB} = 3\text{ V}$	μA		0.03	0.2		0.03	0.2
I_{EBO}	Emitter Cutoff Current $V_{EB} = 1\text{ V}$	μA		0.1	1.5		0.1	1.5

Notes:

1. Test circuit B, Figure 1. Numbers reflect device performance de-embedded from circuit losses.
Input loss = 0.4 dB; output loss = 0.4 dB.
2. Test circuit A, Figure 1. Numbers reflect device performance de-embedded from circuit losses.
Input loss = 0.4 dB; output loss = 0.4 dB.

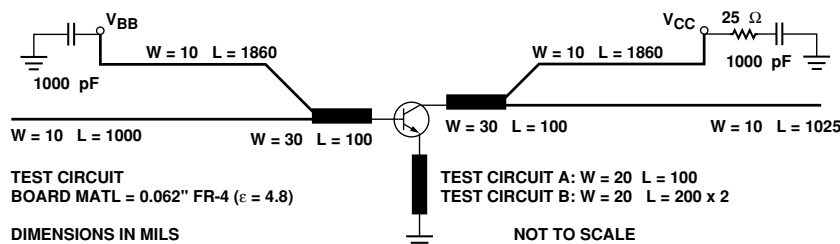

Figure 1. Test Circuit for Noise Figure and Associated Gain. This Circuit is a Compromise Match Between Best Noise Figure, Best Gain, Stability, a Practical, Synthesizable Match, and a Circuit Capable of Matching Both the AT-305 and AT-310 Geometries.

AT-30511, AT-30533 Characterization Information, $T_A = 25^\circ\text{C}$

Symbol	Parameters and Test Conditions	Units	AT-30511	AT-30533
			Typ	Typ
$P_{1\text{dB}}$	Power at 1 dB Gain Compression (opt tuning) $V_{\text{CE}} = 2.7\text{ V}$, $I_{\text{C}} = 5\text{ mA}$ $f = 0.9\text{ GHz}$	dBm	7	7
$G_{1\text{dB}}$	Gain at 1 dB Gain Compression (opt tuning) $V_{\text{CE}} = 2.7\text{ V}$, $I_{\text{C}} = 5\text{ mA}$ $f = 0.9\text{ GHz}$	dB	16.5	15
IP_3	Output Third Order Intercept Point, $V_{\text{CE}} = 2.7\text{ V}$, $I_{\text{C}} = 5\text{ mA}$ (opt tuning) $f = 0.9\text{ GHz}$	dBm	17	17
$ S_{21} _{E^2}$	Gain in $50\ \Omega$ System; $V_{\text{CE}} = 2.7\text{ V}$, $I_{\text{C}} = 1\text{ mA}$ $f = 0.9\text{ GHz}$	dB	10	9
C_{CB}	Collector-Base Capacitance $V_{\text{CB}} = 3\text{ V}$, $f = 1\text{ MHz}$	pF	0.04	0.04

Typical Performance

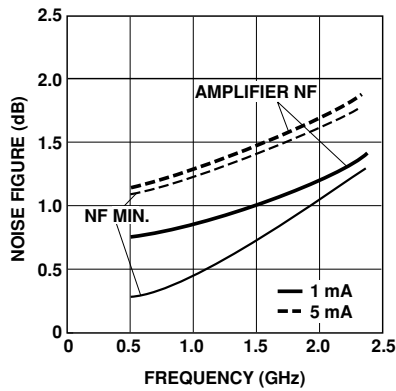

Figure 2. AT-30511 and AT-30533 Minimum Noise Figure and Amplifier NF^[1] vs. Frequency and Current at $V_{\text{CE}} = 2.7\text{ V}$.

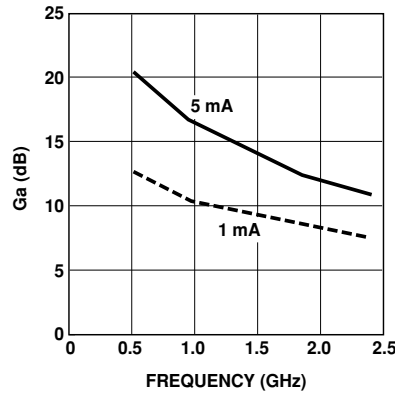

Figure 3. AT-30511 Associated Gain at Optimum Noise Match vs. Frequency and Current at $V_{\text{CE}} = 2.7\text{ V}$.

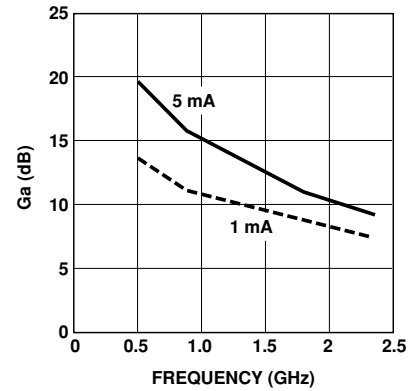

Figure 4. AT-30533 Associated Gain at Optimum Noise Match vs. Frequency and Current at $V_{\text{CE}} = 2.7\text{ V}$.

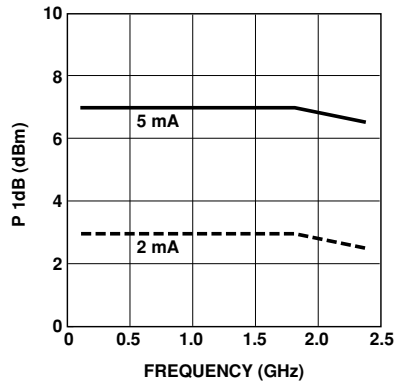

Figure 5. AT-30511 and AT-30533 Power at 1 dB Gain Compression vs. Frequency and Current at $V_{\text{CE}} = 2.7\text{ V}$.

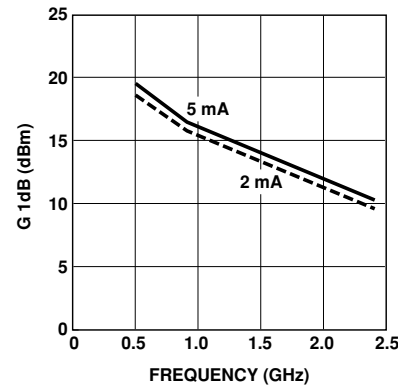

Figure 6. AT-30511 1 dB Compressed Gain vs. Frequency and Current at $V_{\text{CE}} = 2.7\text{ V}$.

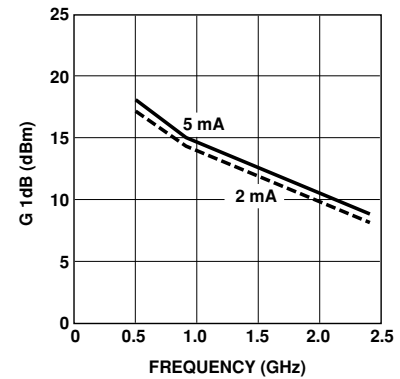

Figure 7. AT-30533 1 dB Compressed Gain vs. Frequency and Current at $V_{\text{CE}} = 2.7\text{ V}$.

Note:

1. Amplifier NF represents the noise figure which can be expected in a real circuit representing reasonable reflection coefficients and including circuit losses.

AT-30511, AT-30533 Typical Performance, continued

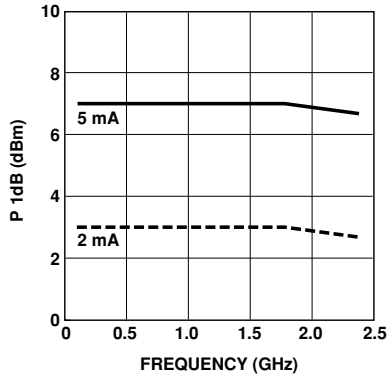

Figure 8. AT-30511 and AT-30533 Power at 1 dB Gain Compression vs. Frequency and Current at $V_{CE} = 5$ V.

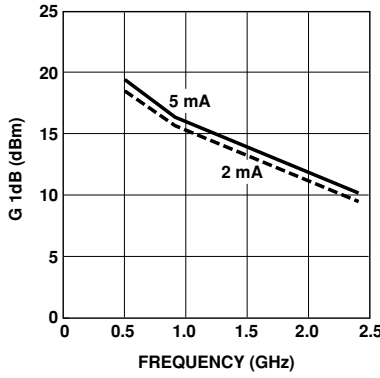

Figure 9. AT-30511 1 dB Compressed Gain vs. Frequency and Current at $V_{CE} = 5$ V.

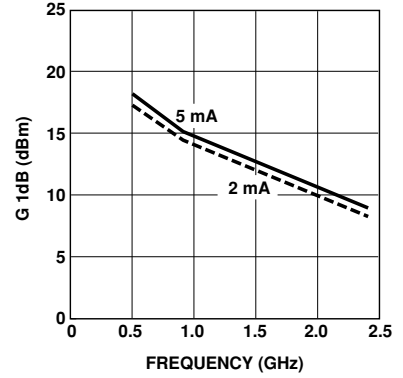

Figure 10. AT-30533 1 dB Compressed Gain vs. Frequency and Current at $V_{CE} = 5$ V.

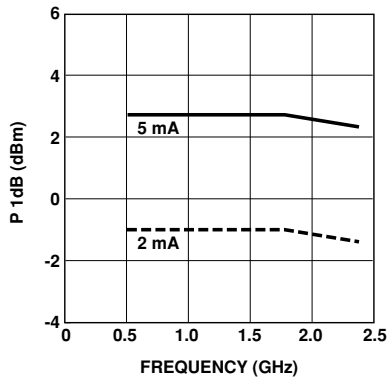

Figure 11. AT-30511 and AT-30533 Power at 1 dB Gain Compression vs. Frequency and Current at $V_{CE} = 1$ V.

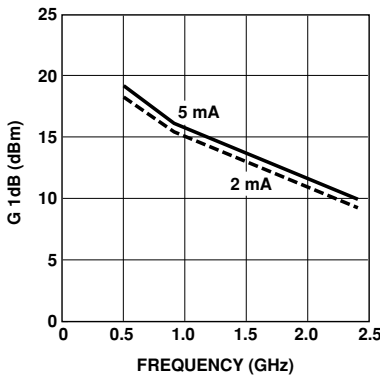

Figure 12. AT-30511 1 dB Compressed Gain vs. Frequency and Current at $V_{CE} = 1$ V.

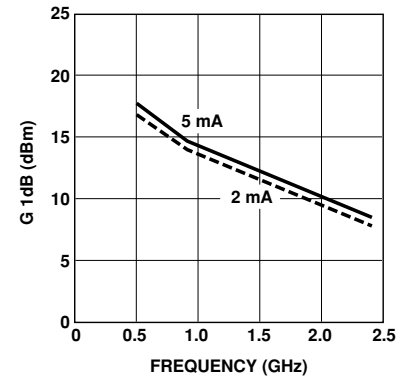

Figure 13. AT-30533 1 dB Compressed Gain vs. Frequency and Current at $V_{CE} = 1$ V.

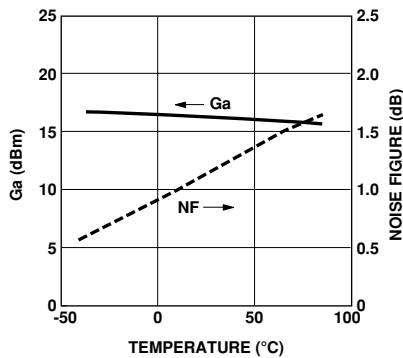

Figure 14. AT-30511 Noise Figure and Associated Gain at $V_{CE} = 2.7$ V, $I_C = 1$ mA vs. Temperature in Test Circuit, Figure 1. (Circuit Losses De-embedded)

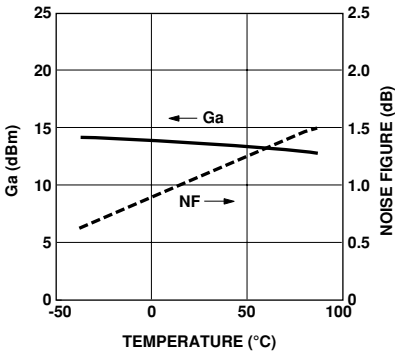

Figure 15. AT-30533 Noise Figure and Associated Gain at $V_{CE} = 2.7$ V, $I_C = 1$ mA vs. Temperature in Test Circuit, Figure 1. (Circuit Losses De-embedded)

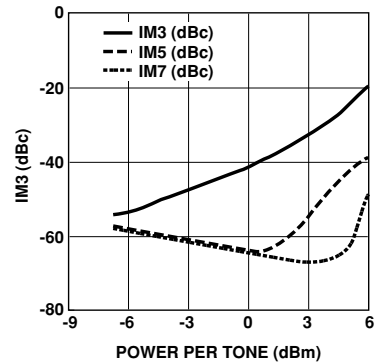

Figure 16. AT-30511 and AT-30533 Intermodulation Products vs. Output Power at $V_{CE} = 2.7$ V, $I_C = 10$ mA, 900 MHz with Optimal Tuning.

AT-30511 Typical Scattering Parameters, $V_{CE} = 1\text{ V}$, $I_C = 1\text{ mA}$, Common Emitter, $Z_O = 50\ \Omega$

Freq. GHz	S_{11}		S_{21}			S_{12}			S_{22}	
	Mag	Ang	dB	Mag	Ang	dB	Mag	Ang	Mag	Ang
0.1	0.97	-5	10.84	3.48	175	-39.42	0.01	86	0.99	-2
0.5	0.95	-24	10.51	3.35	155	-25.87	0.05	72	0.95	-14
0.9	0.85	-42	9.96	3.15	137	-21.46	0.08	61	0.92	-24
1.0	0.83	-46	9.66	3.04	133	-20.71	0.09	58	0.91	-26
1.5	0.70	-67	8.71	2.73	113	-18.44	0.12	46	0.84	-36
1.8	0.63	-78	8.06	2.53	102	-17.69	0.13	41	0.80	-40
2.0	0.59	-85	7.75	2.44	96	-17.27	0.14	37	0.77	-43
2.4	0.50	-100	6.73	2.17	84	-16.79	0.14	32	0.73	-48
3.0	0.39	-122	5.58	1.90	67	-16.32	0.15	27	0.68	-53
4.0	0.29	-161	3.97	1.58	45	-15.87	0.16	20	0.63	-63
5.0	0.27	153	2.64	1.36	25	-15.47	0.17	20	0.61	-72

AT-30511 Typical Noise Parameters,

 Common Emitter, $Z_O = 50\ \Omega$, 1 V , $I_C = 1\text{ mA}$

Freq GHz	$F_{min}^{[1]}$ dB	Γ_{OPT}		R_n
		Mag	Ang	
0.5 ^[2]	0.3	0.96	10	1.49
0.9	0.4	0.92	19	1.33
1.8	0.9	0.83	43	0.98
2.4	1.3	0.76	60	0.74

Notes:

1. Matching constraints may make F_{min} values associated with high $|\Gamma_{opt}|$ values unachievable in physical circuits. See Fig. 2 for expected performance.
2. 0.5 GHz noise parameter values are extrapolated, not measured.

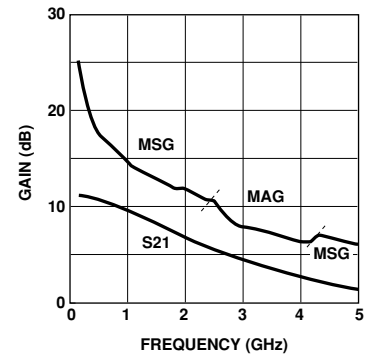
Figure 17. AT-30511 Gains vs. Frequency at $V_{CE} = 1\text{ V}$, $I_C = 1\text{ mA}$.
AT-30533 Typical Scattering Parameters, $V_{CE} = 1\text{ V}$, $I_C = 1\text{ mA}$, Common Emitter, $Z_O = 50\ \Omega$

Freq. GHz	S_{11}		S_{21}			S_{12}			S_{22}	
	Mag	Ang	dB	Mag	Ang	dB	Mag	Ang	Mag	Ang
0.1	0.95	-5	10.90	3.51	174	-38.36	0.01	87	0.99	-3
0.5	0.91	-25	10.32	3.28	150	-25.08	0.06	73	0.95	-14
0.9	0.77	-41	9.44	2.97	128	-20.95	0.09	63	0.89	-24
1.0	0.73	-45	9.03	2.83	124	-20.21	0.10	61	0.88	-25
1.5	0.55	-62	7.75	2.44	102	-18.13	0.12	54	0.80	-33
1.8	0.46	-71	6.94	2.22	91	-17.33	0.14	51	0.77	-36
2.0	0.41	-76	6.51	2.12	85	-16.84	0.14	50	0.74	-38
2.4	0.30	-85	5.45	1.87	73	-16.05	0.16	49	0.71	-41
3.0	0.17	-95	4.26	1.63	57	-14.80	0.18	49	0.68	-46
4.0	0.02	-139	2.71	1.37	37	-12.58	0.24	48	0.65	-57
5.0	0.12	61	1.56	1.20	19	-10.14	0.31	45	0.62	-69

AT-30533 Typical Noise Parameters,

 Common Emitter, $Z_O = 50\ \Omega$, 1 V , $I_C = 1\text{ mA}$

Freq GHz	$F_{min}^{[1]}$ dB	Γ_{OPT}		R_n
		Mag	Ang	
0.5 ^[2]	0.3	0.94	7	1.02
0.9	0.4	0.89	16	0.86
1.8	0.9	0.75	43	0.58
2.4	1.3	0.65	65	0.38

Notes:

1. Matching constraints may make F_{min} values associated with high $|\Gamma_{opt}|$ values unachievable in physical circuits. See Fig. 2 for expected performance.
2. 0.5 GHz noise parameter values are extrapolated, not measured.

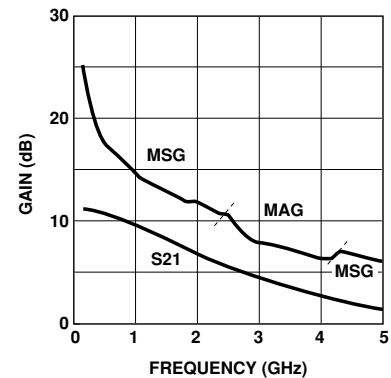
Figure 18. AT-30533 Gains vs. Frequency at $V_{CE} = 2.7\text{ V}$, $I_C = 1\text{ mA}$.

AT-30511 Typical Scattering Parameters, $V_{CE} = 2.7$ V, $I_C = 1$ mA, Common Emitter, $Z_O = 50 \Omega$

Freq. GHz	S_{11}		S_{21}			S_{12}			S_{22}	
	Mag	Ang	dB	Mag	Ang	dB	Mag	Ang	Mag	Ang
0.1	0.97	-5	10.88	3.50	175	-40.13	0.01	86	0.999	-2
0.5	0.95	-23	10.58	3.38	156	-26.71	0.05	74	0.96	-13
0.9	0.86	-39	10.09	3.20	139	-22.28	0.08	63	0.93	-23
1.0	0.84	-43	9.83	3.10	135	-21.51	0.08	60	0.92	-25
1.5	0.72	-63	8.94	2.80	115	-19.15	0.11	49	0.85	-34
1.8	0.65	-73	8.32	2.60	105	-18.28	0.12	43	0.82	-38
2.0	0.61	-80	8.06	2.53	99	-17.83	0.13	40	0.79	-41
2.4	0.52	-93	7.06	2.25	86	-17.29	0.14	35	0.75	-46
3.0	0.41	-114	5.92	1.98	70	-16.72	0.15	30	0.70	-51
4.0	0.30	-150	4.35	1.65	48	-16.13	0.16	23	0.66	-61
5.0	0.26	165	3.06	1.42	28	-15.65	0.16	22	0.63	-69

AT-30511 Typical Noise Parameters,

 Common Emitter, $Z_O = 50 \Omega$, 2.7 V, $I_C = 1$ mA

Freq GHz	$F_{min}^{[1]}$ dB	Γ_{OPT}		R_n
		Mag	Ang	
0.5 ^[2]	0.3	0.96	10	1.49
0.9	0.4	0.92	19	1.33
1.8	0.9	0.83	43	0.98
2.4	1.3	0.76	60	0.74

Notes:

1. Matching constraints may make F_{min} values associated with high $|\Gamma_{opt}|$ values unachievable in physical circuits. See Fig. 2 for expected performance.
2. 0.5 GHz noise parameter values are extrapolated, not measured.

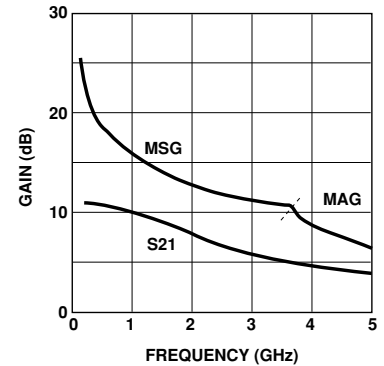
Figure 19. AT-30511 Gains vs. Frequency at $V_{CE} = 2.7$ V, $I_C = 1$ mA.
AT-30533 Typical Scattering Parameters, $V_{CE} = 2.7$ V, $I_C = 1$ mA, Common Emitter, $Z_O = 50 \Omega$

Freq. GHz	S_{11}		S_{21}			S_{12}			S_{22}	
	Mag	Ang	dB	Mag	Ang	dB	Mag	Ang	Mag	Ang
0.1	0.95	-5	10.76	3.45	174	-39.49	0.01	87	0.999	-2
0.5	0.92	-23	10.21	3.24	151	-26.05	0.05	74	0.95	-13
0.9	0.78	-39	9.42	2.96	130	-21.78	0.08	64	0.91	-22
1.0	0.75	-42	9.04	2.83	126	-21.05	0.09	63	0.90	-23
1.5	0.58	-59	7.83	2.46	105	-18.88	0.11	55	0.83	-31
1.8	0.49	-66	7.04	2.25	94	-18.08	0.12	53	0.79	-34
2.0	0.44	-71	6.64	2.15	88	-17.58	0.13	52	0.77	-36
2.4	0.33	-79	5.59	1.90	76	-16.77	0.15	51	0.74	-39
3.0	0.21	-87	4.40	1.66	60	-15.50	0.17	51	0.71	-44
4.0	0.05	-88	2.87	1.39	40	-13.20	0.22	52	0.68	-54
5.0	0.09	47	1.72	1.22	22	-10.67	0.29	49	0.66	-66

AT-30533 Typical Noise Parameters,

 Common Emitter, $Z_O = 50 \Omega$, 2.7 V, $I_C = 1$ mA

Freq GHz	$F_{min}^{[1]}$ dB	Γ_{OPT}		R_n
		Mag	Ang	
0.5 ^[2]	0.3	0.94	7	1.02
0.9	0.4	0.89	16	0.88
1.8	0.9	0.75	43	0.58
2.4	1.3	0.65	65	0.38

Notes:

1. Matching constraints may make F_{min} values associated with high $|\Gamma_{opt}|$ values unachievable in physical circuits. See Fig. 2 for expected performance.
2. 0.5 GHz noise parameter values are extrapolated, not measured.

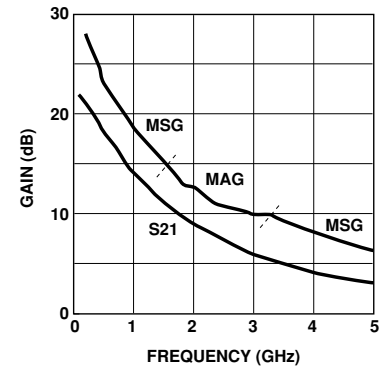
Figure 20. AT-30533 Gains vs. Frequency at $V_{CE} = 2.7$ V, $I_C = 1$ mA.

AT-30511 Typical Scattering Parameters, $V_{CE} = 2.7\text{ V}$, $I_C = 5\text{ mA}$, Common Emitter, $Z_O = 50\ \Omega$

Freq. GHz	S_{11}		S_{21}			S_{12}			S_{22}	
	Mag	Ang	dB	Mag	Ang	dB	Mag	Ang	Mag	Ang
0.1	0.88	-11	22.49	13.32	169	-40.50	0.01	83	0.97	-5
0.5	0.70	-48	20.42	10.49	134	-28.45	0.04	64	0.82	-22
0.9	0.49	-72	17.77	7.73	111	-25.24	0.05	57	0.70	-30
1.0	0.46	-77	17.09	7.15	107	-24.70	0.06	55	0.69	-31
1.5	0.30	-100	14.44	5.27	89	-22.62	0.07	53	0.62	-35
1.8	0.24	-112	13.10	4.52	81	-21.65	0.08	52	0.59	-37
2.0	0.21	-120	12.31	4.13	76	-21.05	0.09	52	0.58	-39
2.4	0.16	-140	10.94	3.52	67	-20.01	0.10	50	0.57	-42
3.0	0.13	-172	9.18	2.88	55	-18.55	0.12	48	0.55	-46
4.0	0.15	137	7.03	2.25	38	-16.57	0.15	44	0.53	-55
5.0	0.21	106	5.44	1.87	22	-14.88	0.18	39	0.52	-64

AT-30511 Typical Noise Parameters,
 Common Emitter, $Z_O = 50\ \Omega$, 2.7 V , $I_C = 5\text{ mA}$

Freq GHz	$F_{min}^{[1]}$ dB	Γ_{OPT}		R_n
		Mag	Ang	
0.5 ^[2]	1.1	0.77	9	1.10
0.9	1.2	0.71	18	0.96
1.8	1.5	0.60	45	0.66
2.4	1.8	0.51	65	0.47

Notes:

1. Matching constraints may make F_{min} values associated with high $|\Gamma_{opt}|$ values unachievable in physical circuits. See Fig. 2 for expected performance.
2. 0.5 GHz noise parameter values are extrapolated, not measured.

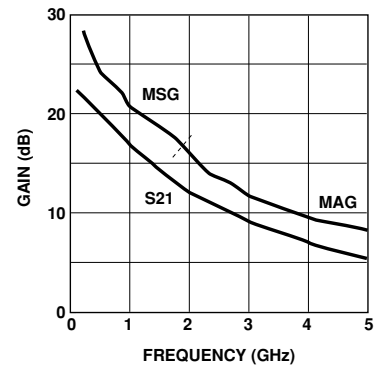
Figure 21. AT-30511 Gains vs. Frequency at $V_{CE} = 2.7\text{ V}$, $I_C = 5\text{ mA}$.
AT-30533 Typical Scattering Parameters, $V_{CE} = 2.7\text{ V}$, $I_C = 5\text{ mA}$, Common Emitter, $Z_O = 50\ \Omega$

Freq. GHz	S_{11}		S_{21}			S_{12}			S_{22}	
	Mag	Ang	dB	Mag	Ang	dB	Mag	Ang	Mag	Ang
0.1	0.84	-12	22.26	12.98	164	-39.96	0.01	82	0.98	-5
0.5	0.57	-39	18.54	8.46	121	-28.03	0.04	71	0.80	-18
0.9	0.37	-46	14.97	5.60	100	-24.09	0.06	70	0.73	-22
1.0	0.34	-46	14.20	5.13	96	-23.32	0.07	69	0.72	-22
1.5	0.23	-43	11.24	3.65	81	-20.30	0.10	68	0.69	-26
1.8	0.20	-38	9.85	3.11	73	-18.88	0.11	67	0.68	-28
2.0	0.19	-35	9.05	2.84	69	-18.02	0.13	66	0.68	-30
2.4	0.17	-27	7.70	2.43	61	-16.50	0.15	64	0.67	-33
3.0	0.15	-17	6.12	2.02	50	-14.57	0.19	61	0.66	-39
4.0	0.15	-2	4.30	1.64	34	-11.90	0.25	55	0.64	-49
5.0	0.17	11	3.07	1.42	19	-9.66	0.33	47	0.61	-61

AT-30533 Typical Noise Parameters,
 Common Emitter, $Z_O = 50\ \Omega$, 2.7 V , $I_C = 5\text{ mA}$

Freq GHz	$F_{min}^{[1]}$ dB	Γ_{OPT}		R_n
		Mag	Ang	
0.5 ^[2]	1.1	0.71	8	0.78
0.9	1.2	0.61	16	0.66
1.8	1.5	0.42	39	0.41
2.4	1.8	0.28	57	0.25

Notes:

1. Matching constraints may make F_{min} values associated with high $|\Gamma_{opt}|$ values unachievable in physical circuits. See Fig. 2 for expected performance.
2. 0.5 GHz noise parameter values are extrapolated, not measured.

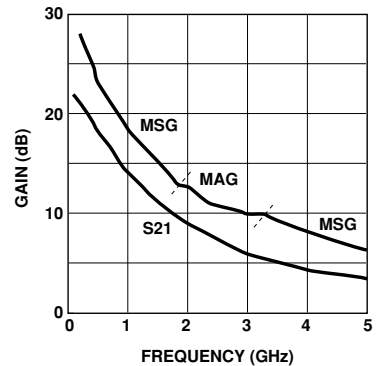
Figure 22. AT-30533 Gains vs. Frequency at $V_{CE} = 2.7\text{ V}$, $I_C = 5\text{ mA}$.

AT-30511 Typical Scattering Parameters, $V_{CE} = 5\text{ V}$, $I_C = 1\text{ mA}$, Common Emitter, $Z_O = 50\ \Omega$

Freq. GHz	S_{11}		S_{21}			S_{12}			S_{22}	
	Mag	Ang	dB	Mag	Ang	dB	Mag	Ang	Mag	Ang
0.1	0.98	-5	10.56	3.37	175	-40.34	0.01	87	0.999	-2
0.5	0.96	-21	10.30	3.27	157	-26.99	0.04	74	0.96	-13
0.9	0.88	-37	9.83	3.10	139	-22.52	0.07	64	0.93	-22
1.0	0.85	-41	9.57	3.01	136	-21.75	0.08	62	0.92	-24
1.5	0.74	-59	8.71	2.73	116	-19.23	0.11	51	0.86	-33
1.8	0.67	-69	8.13	2.55	106	-18.34	0.12	45	0.82	-38
2.0	0.63	-75	7.88	2.48	100	-17.85	0.13	42	0.80	-41
2.4	0.55	-88	6.90	2.21	87	-17.23	0.14	37	0.77	-45
3.0	0.43	-106	5.79	1.95	71	-16.53	0.15	31	0.72	-50
4.0	0.31	-138	4.29	1.64	49	-15.83	0.16	23	0.67	-60
5.0	0.25	178	3.04	1.42	29	-15.38	0.17	20	0.64	-69

AT-30511 Typical Noise Parameters,
 Common Emitter, $Z_O = 50\ \Omega$, 5 V , $I_C = 1\text{ mA}$

Freq GHz	$F_{\min}^{[1]}$ dB	Γ_{OPT}		R_n
		Mag	Ang	
0.5 ^[2]	0.3	0.96	10	1.49
0.9	0.4	0.92	19	1.33
1.8	0.9	0.83	43	0.98
2.4	1.3	0.76	60	0.74

Notes:

1. Matching constraints may make F_{\min} values associated with high $|\Gamma_{\text{opt}}|$ values unachievable in physical circuits. See Fig. 2 for expected performance.
2. 0.5 GHz noise parameter values are extrapolated, not measured.

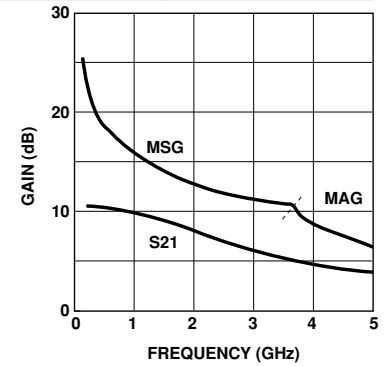
Figure 23. AT-30511 Gains vs. Frequency at $V_{CE} = 5\text{ V}$, $I_C = 1\text{ mA}$.
AT-30533 Typical Scattering Parameters, $V_{CE} = 5\text{ V}$, $I_C = 1\text{ mA}$, Common Emitter, $Z_O = 50\ \Omega$

Freq. GHz	S_{11}		S_{21}			S_{12}			S_{22}	
	Mag	Ang	dB	Mag	Ang	dB	Mag	Ang	Mag	Ang
0.1	0.96	-5	10.59	3.38	174	-39.38	0.01	85	0.999	-2
0.5	0.92	-22	10.07	3.19	151	-26.22	0.05	74	0.95	-13
0.9	0.79	-37	9.32	2.92	131	-21.99	0.08	65	0.91	-21
1.0	0.77	-41	8.94	2.80	127	-21.21	0.09	63	0.90	-23
1.5	0.60	-57	7.76	2.44	106	-19.02	0.11	56	0.83	-30
1.8	0.51	-64	7.01	2.24	95	-18.16	0.12	54	0.80	-33
2.0	0.46	-69	6.61	2.14	89	-17.66	0.13	52	0.78	-35
2.4	0.35	-76	5.59	1.90	77	-16.85	0.14	51	0.75	-39
3.0	0.23	-83	4.43	1.66	61	-15.58	0.17	51	0.72	-43
4.0	0.07	-85	2.92	1.40	41	-13.34	0.22	52	0.69	-53
5.0	0.07	38	1.79	1.23	23	-10.85	0.29	49	0.67	-65

AT-30533 Typical Noise Parameters,
 Common Emitter, $Z_O = 50\ \Omega$, 5 V , $I_C = 1\text{ mA}$

Freq GHz	$F_{\min}^{[1]}$ dB	Γ_{OPT}		R_n
		Mag	Ang	
0.5 ^[2]	0.3	0.94	7	1.02
0.9	0.4	0.89	16	0.98
1.8	0.9	0.75	43	0.58
2.4	1.3	0.65	65	0.38

Notes:

1. Matching constraints may make F_{\min} values associated with high $|\Gamma_{\text{opt}}|$ values unachievable in physical circuits. See Figure 2 for expected performance.
2. 0.5 GHz noise parameter values are extrapolated, not measured.

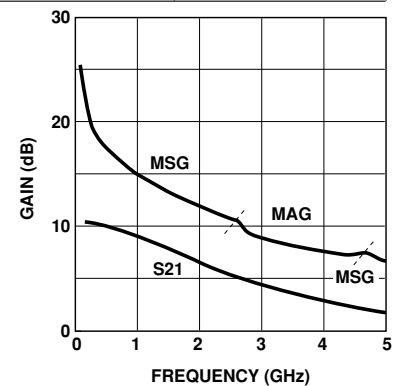
Figure 24. AT-30533 Gains vs. Frequency at $V_{CE} = 5\text{ V}$, $I_C = 1\text{ mA}$.

AT-30511 Typical Scattering Parameters, $V_{CE} = 5\text{ V}$, $I_C = 5\text{ mA}$, Common Emitter, $Z_O = 50\ \Omega$

Freq. GHz	S_{11}		S_{21}			S_{12}			S_{22}	
	Mag	Ang	dB	Mag	Ang	dB	Mag	Ang	Mag	Ang
0.1	0.90	-10	22.26	12.98	170	-40.75	0.01	82	0.97	-5
0.5	0.74	-43	20.41	10.49	136	-28.46	0.04	66	0.83	-22
0.9	0.53	-66	17.93	7.88	113	-25.18	0.06	58	0.72	-30
1.0	0.49	-70	17.28	7.31	109	-24.53	0.06	57	0.70	-31
1.5	0.33	-89	14.72	5.45	91	-22.46	0.08	54	0.63	-36
1.8	0.27	-99	13.41	4.68	83	-21.45	0.08	53	0.60	-38
2.0	0.24	-105	12.64	4.29	78	-20.87	0.09	52	0.59	-39
2.4	0.18	-120	11.27	3.66	69	-19.79	0.10	50	0.57	-42
3.0	0.12	-147	9.54	3.00	57	-18.34	0.12	48	0.55	-46
4.0	0.11	154	7.41	2.35	40	-16.45	0.15	43	0.53	-55
5.0	0.17	114	5.86	1.96	24	-14.84	0.18	38	0.52	-63

AT-30511 Typical Noise Parameters,

 Common Emitter, $Z_O = 50\ \Omega$, 5 V , $I_C = 5\text{ mA}$

Freq GHz	$F_{\min}^{[1]}$ dB	Γ_{OPT}		R_n
		Mag	Ang	
0.5 ^[2]	1.1	0.77	9	1.10
0.9	1.2	0.71	18	0.96
1.8	1.5	0.60	45	0.66
2.4	1.8	0.51	65	0.47

Notes:

1. Matching constraints may make F_{\min} values associated with high $|\Gamma_{\text{opt}}|$ values unachievable in physical circuits. See Fig. 2 for expected performance.
2. 0.5 GHz noise parameter values are extrapolated, not measured.

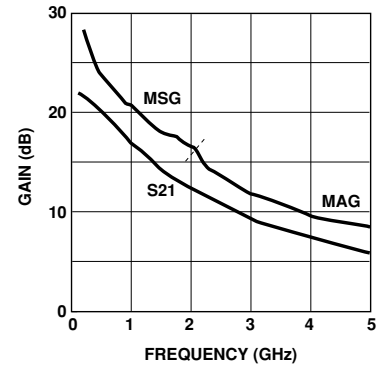
Figure 25. AT-30511 Gains vs. Frequency at $V_{CE} = 5\text{ V}$, $I_C = 5\text{ mA}$.
AT-30533 Typical Scattering Parameters, $V_{CE} = 5\text{ V}$, $I_C = 5\text{ mA}$, Common Emitter, $Z_O = 50\ \Omega$

Freq. GHz	S_{11}		S_{21}			S_{12}			S_{22}	
	Mag	Ang	dB	Mag	Ang	dB	Mag	Ang	Mag	Ang
0.1	0.86	-11	22.22	12.92	165	-40.16	0.01	83	0.98	-5
0.5	0.59	-37	18.69	8.60	122	-28.05	0.04	72	0.81	-18
0.9	0.40	-43	15.19	5.75	101	-24.14	0.06	70	0.74	-22
1.0	0.37	-43	14.43	5.27	97	-23.37	0.07	70	0.73	-22
1.5	0.27	-40	11.49	3.75	82	-20.30	0.10	68	0.70	-26
1.8	0.24	-37	10.11	3.20	75	-18.88	0.11	67	0.69	-28
2.0	0.23	-35	9.33	2.93	70	-18.05	0.13	66	0.68	-30
2.4	0.20	-30	7.97	2.50	62	-16.55	0.15	64	0.67	-33
3.0	0.18	-24	6.40	2.09	51	-14.64	0.19	61	0.66	-38
4.0	0.17	-14	4.58	1.70	36	-12.00	0.25	54	0.64	-49
5.0	0.16	-2	3.37	1.47	21	-9.83	0.32	46	0.61	-60

AT-30533 Typical Noise Parameters,

 Common Emitter, $Z_O = 50\ \Omega$, 5 V , $I_C = 5\text{ mA}$

Freq GHz	$F_{\min}^{[1]}$ dB	Γ_{OPT}		R_n
		Mag	Ang	
0.5 ^[2]	1.1	0.71	8	0.78
0.9	1.2	0.61	16	0.66
1.8	1.5	0.42	39	0.41
2.4	1.8	0.28	57	0.25

Notes:

1. Matching constraints may make F_{\min} values associated with high $|\Gamma_{\text{opt}}|$ values unachievable in physical circuits. See Fig. 2 for expected performance.
2. 0.5 GHz noise parameter values are extrapolated, not measured.

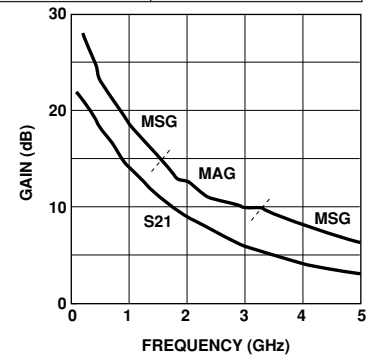
Figure 26. AT-30533 Gains vs. Frequency at $V_{CE} = 5\text{ V}$, $I_C = 5\text{ mA}$.

Ordering Information

Part Numbers		No. of Devices	Comments
AT-30511-BLK	AT-30533-BLK	100	Bulk
AT-30511-BLKG	AT-30533-BLKG	100	Bulk
AT-30511-TR1	AT-30533-TR1	3000	7" Reel
AT-30511-TR1G	AT-30533-TR1G	3000	7" Reel
AT-30511-TR2	AT-30533-TR2	10000	13" Reel
AT-30511-TR2G	AT-30533-TR2G	10000	13" Reel

Note: Order part number with a "G" suffix if lead-free option is desired.

Package Dimensions

SOT-23 Plastic Package

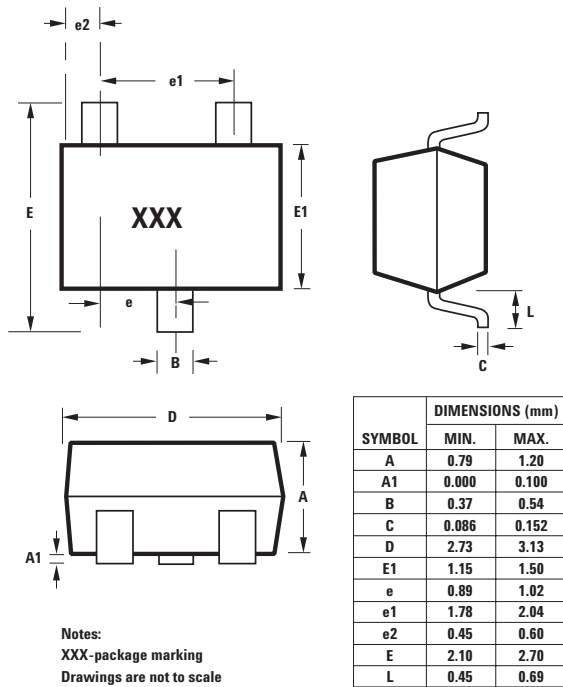

SOT-143 Plastic Package

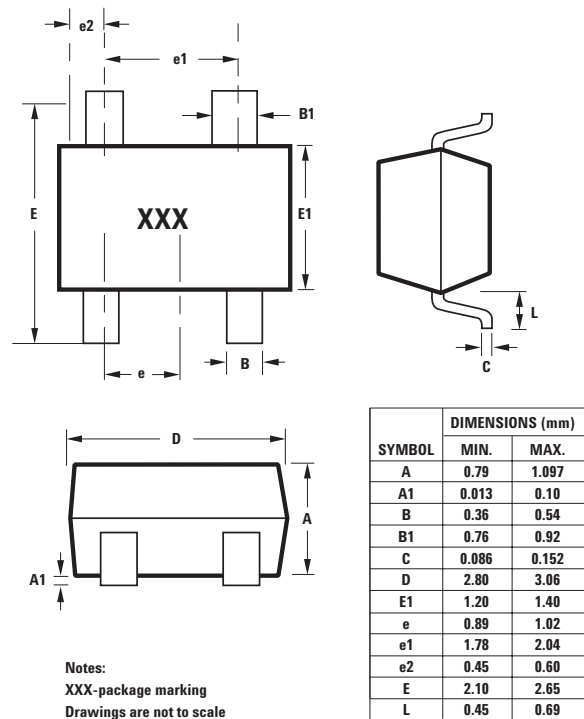

www.agilent.com/semiconductors

For product information and a complete list of distributors, please go to our web site.

For technical assistance call:

Americas/Canada: +1 (800) 235-0312 or
(916) 788-6763

Europe: +49 (0) 6441 92460

China: 10800 650 0017

Hong Kong: (65) 6756 2394

India, Australia, New Zealand: (65) 6755 1939

Japan: (+81 3) 3335-8152(Domestic/International), or
0120-61-1280(Domestic Only)

Korea: (65) 6755 1989

Singapore, Malaysia, Vietnam, Thailand, Philippines,
Indonesia: (65) 6755 2044

Taiwan: (65) 6755 1843

Data subject to change.

Copyright © 2005 Agilent Technologies, Inc.

Obsoletes 5965-8918E

March 28, 2005

5989-2641EN



Agilent Technologies