

ON Semiconductor

Is Now

onsemi™

To learn more about onsemi™, please visit our website at
www.onsemi.com

onsemi and **onsemi** and other names, marks, and brands are registered and/or common law trademarks of Semiconductor Components Industries, LLC dba "**onsemi**" or its affiliates and/or subsidiaries in the United States and/or other countries. **onsemi** owns the rights to a number of patents, trademarks, copyrights, trade secrets, and other intellectual property. A listing of **onsemi** product/patent coverage may be accessed at www.onsemi.com/site/pdf/Patent-Marking.pdf. **onsemi** reserves the right to make changes at any time to any products or information herein, without notice. The information herein is provided "as-is" and **onsemi** makes no warranty, representation or guarantee regarding the accuracy of the information, product features, availability, functionality, or suitability of its products for any particular purpose, nor does **onsemi** assume any liability arising out of the application or use of any product or circuit, and specifically disclaims any and all liability, including without limitation special, consequential or incidental damages. Buyer is responsible for its products and applications using **onsemi** products, including compliance with all laws, regulations and safety requirements or standards, regardless of any support or applications information provided by **onsemi**. "Typical" parameters which may be provided in **onsemi** data sheets and/or specifications can and do vary in different applications and actual performance may vary over time. All operating parameters, including "Typicals" must be validated for each customer application by customer's technical experts. **onsemi** does not convey any license under any of its intellectual property rights nor the rights of others. **onsemi** products are not designed, intended, or authorized for use as a critical component in life support systems or any FDA Class 3 medical devices or medical devices with a same or similar classification in a foreign jurisdiction or any devices intended for implantation in the human body. Should Buyer purchase or use **onsemi** products for any such unintended or unauthorized application, Buyer shall indemnify and hold **onsemi** and its officers, employees, subsidiaries, affiliates, and distributors harmless against all claims, costs, damages, and expenses, and reasonable attorney fees arising out of, directly or indirectly, any claim of personal injury or death associated with such unintended or unauthorized use, even if such claim alleges that **onsemi** was negligent regarding the design or manufacture of the part. **onsemi** is an Equal Opportunity/Affirmative Action Employer. This literature is subject to all applicable copyright laws and is not for resale in any manner. Other names and brands may be claimed as the property of others.

Switching Transistor

NPN Silicon

- This device is available in Pb-free package(s). Specifications herein apply to both standard and Pb-free devices. Please see our website at www.onsemi.com for specific Pb-free orderable part numbers, or contact your local ON Semiconductor sales office or representative.

MAXIMUM RATINGS

Rating	Symbol	Value	Unit
Collector–Emitter Voltage	V_{CEO}	15	Vdc
Collector–Emitter Voltage	V_{CES}	40	Vdc
Collector–Base Voltage	V_{CBO}	40	Vdc
Emitter–Base Voltage	V_{EBO}	5.0	Vdc
Collector Current — Continuous	I_C	300	mAdc
— 10 μ s Pulse		500	
Total Device Dissipation @ $T_A = 25^\circ\text{C}$	P_D	625	mW
Derate above 25°C		5.0	mW/ $^\circ\text{C}$
Total Device Dissipation @ $T_C = 25^\circ\text{C}$	P_D	1.5	Watts
Derate above 25°C		12	mW/ $^\circ\text{C}$
Operating and Storage Junction Temperature Range	T_J, T_{stg}	-55 to +150	$^\circ\text{C}$

THERMAL CHARACTERISTICS

Characteristic	Symbol	Max	Unit
Thermal Resistance, Junction to Ambient	$R_{\theta JA}$	200	$^\circ\text{C}/\text{W}$
Thermal Resistance, Junction to Case	$R_{\theta JC}$	83.3	$^\circ\text{C}/\text{W}$

ELECTRICAL CHARACTERISTICS ($T_A = 25^\circ\text{C}$ unless otherwise noted)

Characteristic	Symbol	Min	Max	Unit
----------------	--------	-----	-----	------

OFF CHARACTERISTICS

Collector–Emitter Breakdown Voltage	($I_C = 100 \mu\text{Adc}, V_{BE} = 0$)	$V_{(BR)CES}$	40	—	Vdc
Collector–Emitter Sustaining Voltage ⁽¹⁾	($I_C = 10 \text{mAdc}, I_B = 0$)	$V_{CEO(sus)}$	15	—	Vdc
Collector–Base Breakdown Voltage	($I_C = 100 \mu\text{Adc}, I_E = 0$)	$V_{(BR)CBO}$	40	—	Vdc
Emitter–Base Breakdown Voltage	($I_E = 100 \mu\text{Adc}, I_C = 0$)	$V_{(BR)EBO}$	5.0	—	Vdc
Collector Cutoff Current	($V_{CE} = 20 \text{Vdc}, V_{BE} = 0$) ($V_{CE} = 20 \text{Vdc}, V_{BE} = 0, T_A = 65^\circ\text{C}$)	I_{CES}	—	0.5	μAdc
			—	3.0	

ON CHARACTERISTICS⁽¹⁾

DC Current Gain	($I_C = 30 \text{mAdc}, V_{CE} = 0.4 \text{Vdc}$) ($I_C = 100 \text{mAdc}, V_{CE} = 0.5 \text{Vdc}$) ($I_C = 300 \text{mA}, V_{CE} = 1.0 \text{Vdc}$)	h_{FE}	30	120	—
			25	—	
			15	—	
Collector–Emitter Saturation Voltage	($I_C = 30 \text{mAdc}, I_B = 3.0 \text{mAdc}$) ($I_C = 100 \text{mAdc}, I_B = 10 \text{mAdc}$) ($I_C = 300 \text{mAdc}, I_B = 30 \text{mAdc}$) ($I_C = 30 \text{mA}, I_B = 3.0 \text{mA}, T_A = 65^\circ\text{C}$)	$V_{CE(sat)}$	—	0.2	Vdc
			—	0.28	
			—	0.5	
			—	0.3	
Base–Emitter Saturation Voltage	($I_C = 30 \text{mAdc}, I_B = 3.0 \text{mAdc}$) ($I_C = 100 \text{mAdc}, I_B = 10 \text{mAdc}$) ($I_C = 300 \text{mAdc}, I_B = 30 \text{mA}$)	$V_{BE(sat)}$	0.73	0.95	Vdc
			—	1.2	
			—	1.7	

1. Pulse Test: Pulse Width $\leq 300 \mu\text{s}$; Duty Cycle $\leq 2.0\%$.

Preferred devices are ON Semiconductor recommended choices for future use and best overall value.

MPS3646

ON Semiconductor Preferred Device

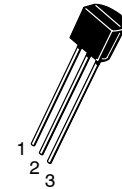

CASE 29-11, STYLE 1
TO-92 (TO-226AA)

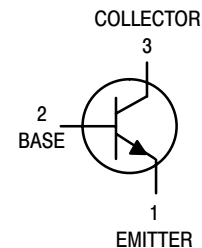

MPS3646

ELECTRICAL CHARACTERISTICS ($T_A = 25^\circ\text{C}$ unless otherwise noted) (Continued)

Characteristic	Symbol	Min	Max	Unit
SMALL-SIGNAL CHARACTERISTICS				
Current-Gain — Bandwidth Product ($I_C = 30\text{ mA}$, $V_{CE} = 10\text{ V}$, $f = 100\text{ MHz}$)	f_T	350	—	MHz
Output Capacitance ($V_{CB} = 5.0\text{ V}$, $I_E = 0$, $f = 1.0\text{ MHz}$)	C_{obo}	—	5.0	pF
Input Capacitance ($V_{EB} = 0.5\text{ V}$, $I_C = 0$, $f = 1.0\text{ MHz}$)	C_{ibo}	—	9.0	pF

SWITCHING CHARACTERISTICS

Turn-On Time	$(V_{CC} = 10\text{ Vdc}$, $I_C = 300\text{ mA}$, $I_{B1} = 30\text{ mA}$) (Figure 1)	t_{on}	—	18	ns
Delay Time		t_d	—	10	ns
Rise Time		t_r	—	15	ns
Turn-Off Time	$(V_{CC} = 10\text{ Vdc}$, $I_C = 300\text{ mA}$, $I_{B1} = I_{B2} = 30\text{ mA}$) (Figure 1)	t_{off}	—	28	ns
Fall Time		t_f	—	15	ns
Storage Time ($V_{CC} = 10\text{ Vdc}$, $I_C = 10\text{ mA}$, $I_{B1} = I_{B2} = 10\text{ mA}$) (Figure 2)		t_s	—	18	ns

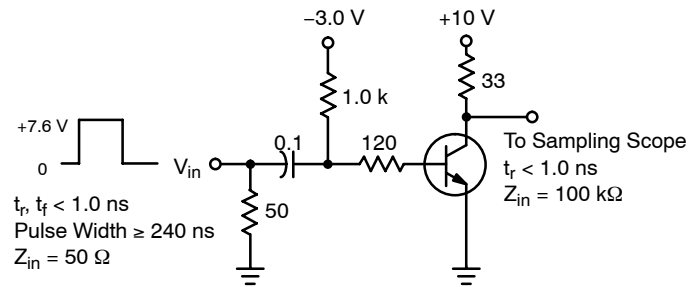

Figure 1. Switching Time Test Circuit

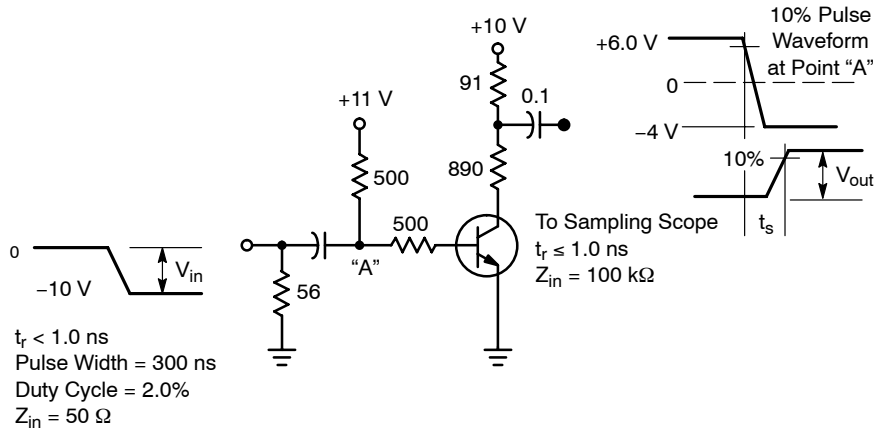

Figure 2. Charge Storage Time Test Circuit

MPS3646

CURRENT GAIN CHARACTERISTICS

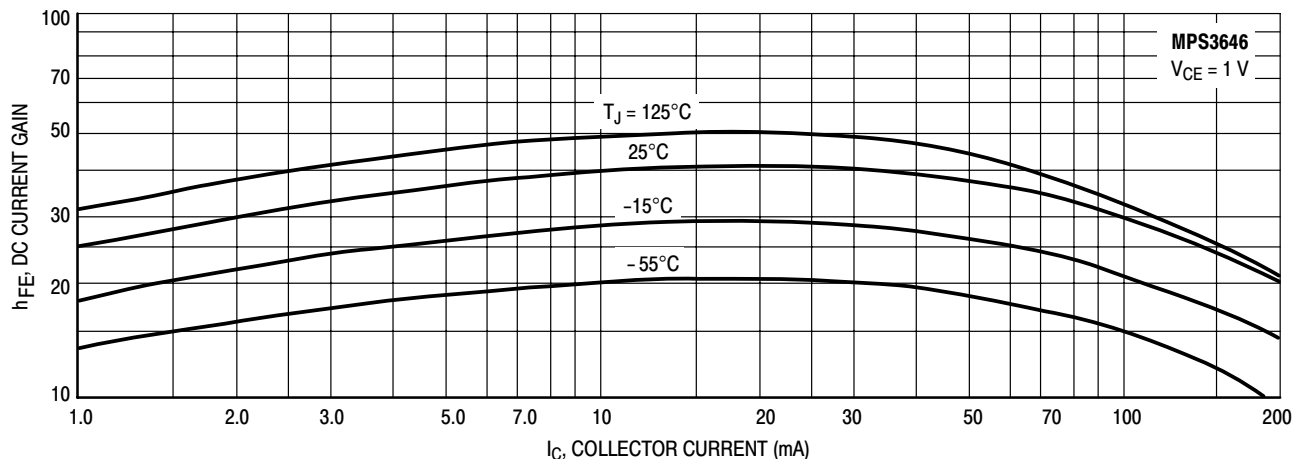

Figure 3. Minimum Current Gain

“ON” CONDITION CHARACTERISTICS

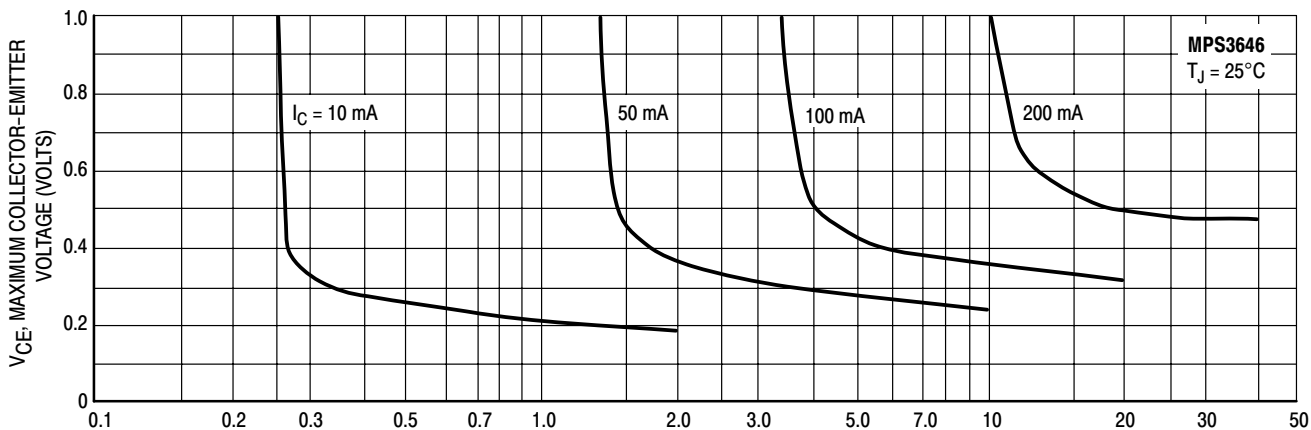

Figure 4. Collector Saturation Region

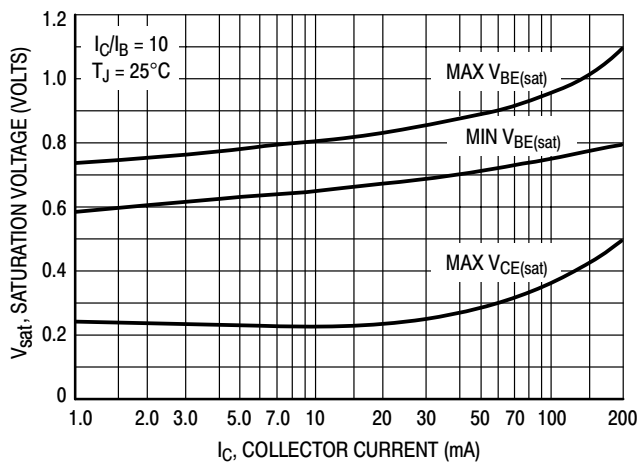

Figure 5. Saturation Voltage Limits

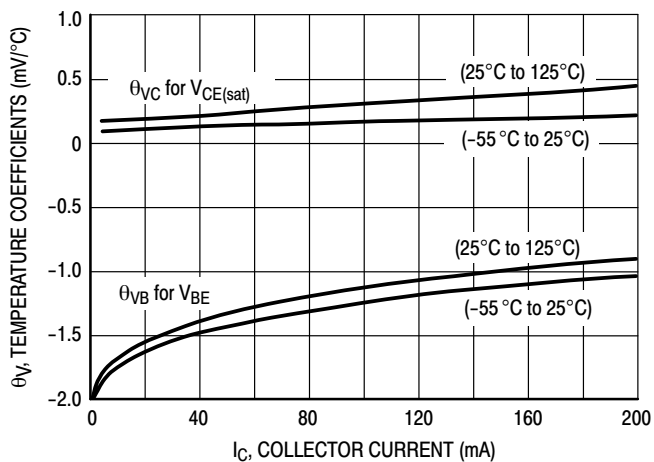

Figure 6. Temperature Coefficients

DYNAMIC CHARACTERISTICS

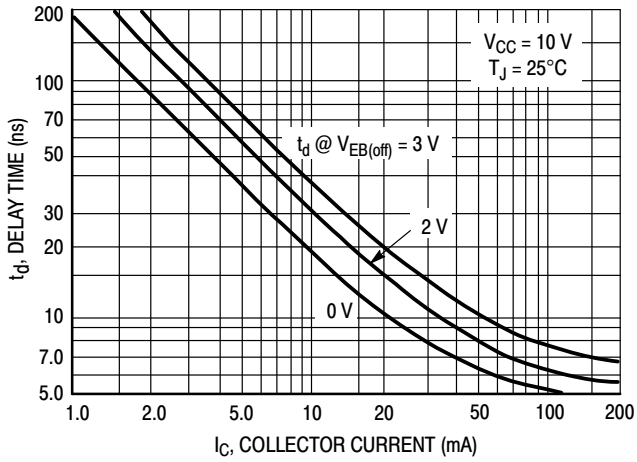

Figure 7. Delay Time

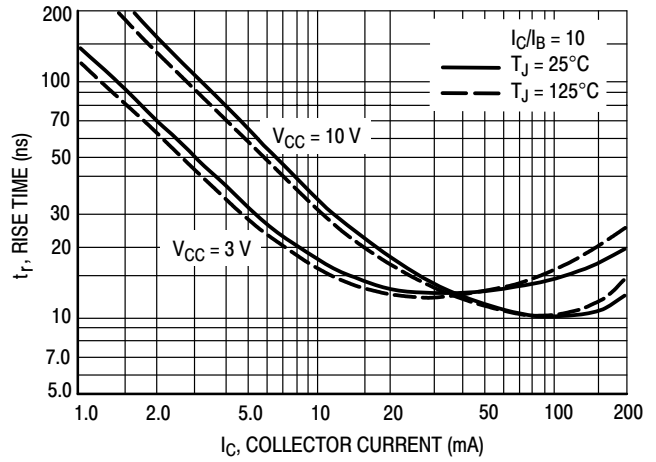

Figure 8. Rise Time

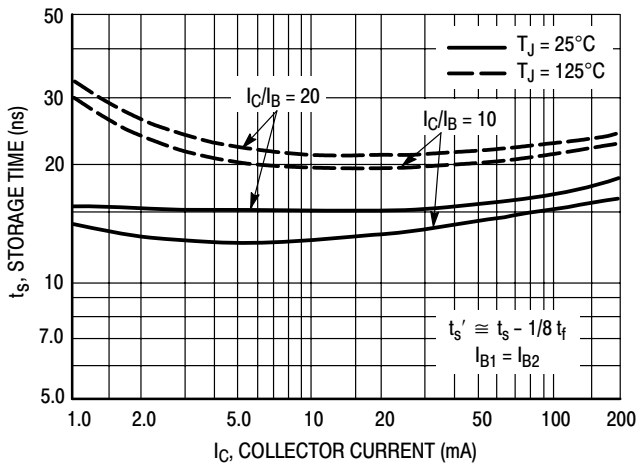

Figure 9. Storage Time

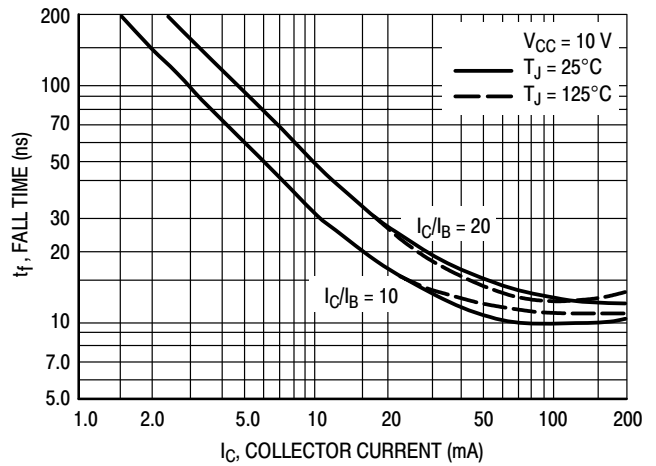

Figure 10. Fall Time

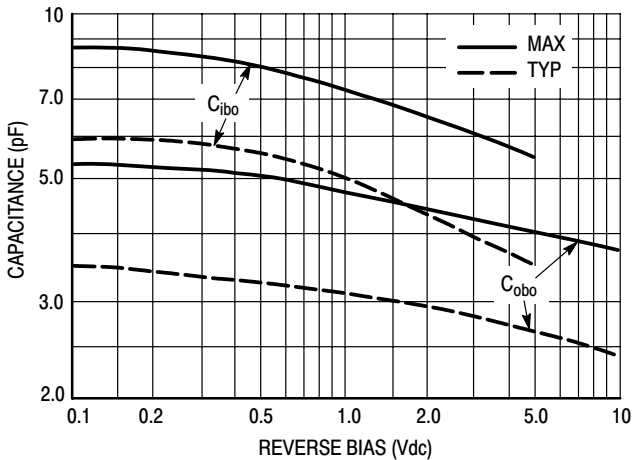

Figure 11. Junction Capacitance

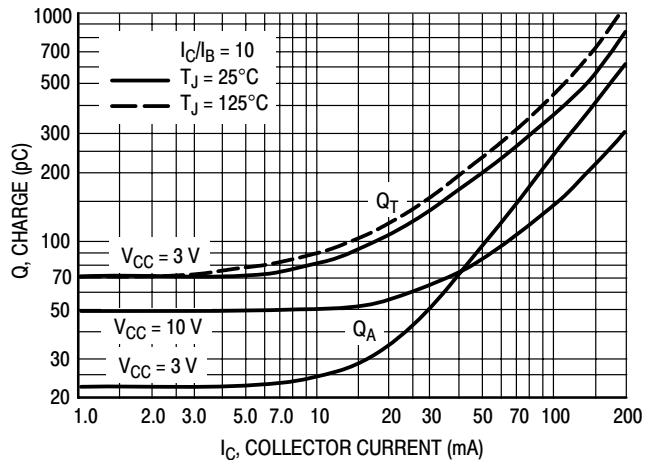
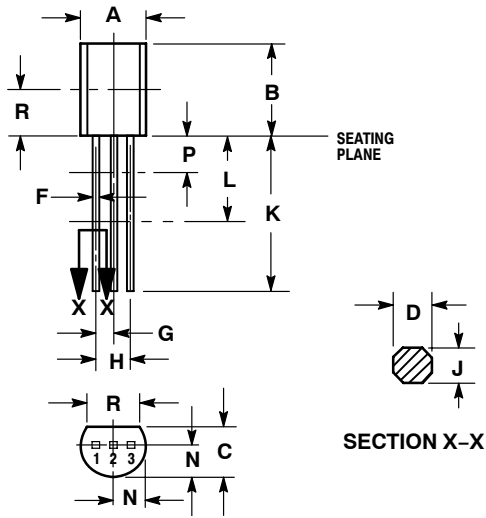

Figure 12. Maximum Charge Data

MPS3646

PACKAGE DIMENSIONS

CASE 029-11 (TO-226AA) ISSUE AD



STYLE 1:
PIN 1. EMITTER
2. BASE
3. COLLECTOR

NOTES:

1. DIMENSIONING AND TOLERANCING PER ANSI Y14.5M, 1982.
2. CONTROLLING DIMENSION: INCH.
3. CONTOUR OF PACKAGE BEYOND DIMENSION R IS UNCONTROLLED.
4. DIMENSION F APPLIES BETWEEN P AND L. DIMENSIONS D AND J APPLY BETWEEN L AND K MINIMUM. LEAD DIMENSION IS UNCONTROLLED IN P AND BEYOND DIMENSION K MINIMUM.

DIM	INCHES		MILLIMETERS	
	MIN	MAX	MIN	MAX
A	0.175	0.205	4.44	5.21
B	0.290	0.310	7.37	7.87
C	0.125	0.165	3.18	4.19
D	0.018	0.021	0.457	0.533
F	0.016	0.019	0.407	0.482
G	0.045	0.055	1.15	1.39
H	0.095	0.105	2.42	2.66
J	0.018	0.024	0.46	0.61
K	0.500	---	12.70	---
L	0.250	---	6.35	---
N	0.080	0.105	2.04	2.66
P	---	0.100	---	2.54
R	0.135	---	3.43	---

Notes

Notes

ON Semiconductor and  are registered trademarks of Semiconductor Components Industries, LLC (SCILLC). SCILLC reserves the right to make changes without further notice to any products herein. SCILLC makes no warranty, representation or guarantee regarding the suitability of its products for any particular purpose, nor does SCILLC assume any liability arising out of the application or use of any product or circuit, and specifically disclaims any and all liability, including without limitation special, consequential or incidental damages. "Typical" parameters which may be provided in SCILLC data sheets and/or specifications can and do vary in different applications and actual performance may vary over time. All operating parameters, including "Typicals" must be validated for each customer application by customer's technical experts. SCILLC does not convey any license under its patent rights nor the rights of others. SCILLC products are not designed, intended, or authorized for use as components in systems intended for surgical implant into the body, or other applications intended to support or sustain life, or for any other application in which the failure of the SCILLC product could create a situation where personal injury or death may occur. Should Buyer purchase or use SCILLC products for any such unintended or unauthorized application, Buyer shall indemnify and hold SCILLC and its officers, employees, subsidiaries, affiliates, and distributors harmless against all claims, costs, damages, and expenses, and reasonable attorney fees arising out of, directly or indirectly, any claim of personal injury or death associated with such unintended or unauthorized use, even if such claim alleges that SCILLC was negligent regarding the design or manufacture of the part. SCILLC is an Equal Opportunity/Affirmative Action Employer. This literature is subject to all applicable copyright laws and is not for resale in any manner.

PUBLICATION ORDERING INFORMATION

LITERATURE FULFILLMENT:

Literature Distribution Center for ON Semiconductor
P.O. Box 61312, Phoenix, Arizona 85082-1312 USA
Phone: 480-829-7710 or 800-344-3860 Toll Free USA/Canada
Fax: 480-829-7709 or 800-344-3867 Toll Free USA/Canada
Email: orderlit@onsemi.com

N. American Technical Support: 800-282-9855 Toll Free
USA/Canada

Japan: ON Semiconductor, Japan Customer Focus Center
2-9-1 Kamimeguro, Meguro-ku, Tokyo, Japan 153-0051
Phone: 81-3-5773-3850

ON Semiconductor Website: <http://onsemi.com>

Order Literature: <http://www.onsemi.com/litorder>

For additional information, please contact your
local Sales Representative.