

REVISIONS			
LTR	DESCRIPTION	DATE	APPROVED
—	INITIAL RELEASE		H D

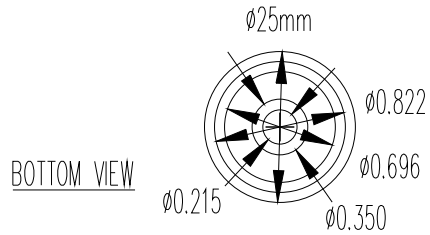
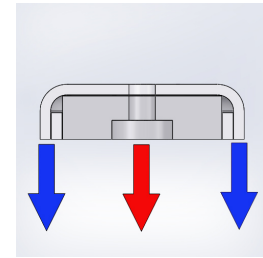
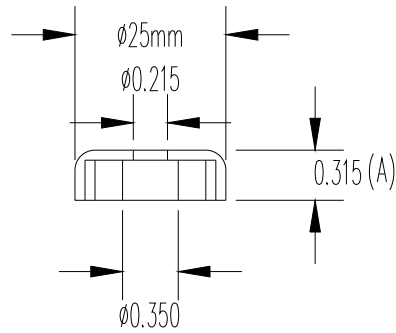
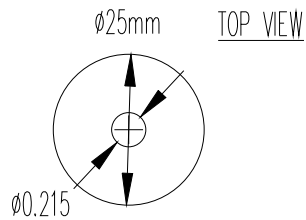

UNLESS OTHERWISE SPECIFIED
DIMENSIONS ARE IN INCHES

TOLERANCES:
FRACTIONS: $\pm 1/64$
DECIMALS: ± 0.015
ANGLES: $\pm 1^\circ$

MATERIAL: NdFeB

FINISH: NiCuNi

RADIAL MAGNETS INC.

108B NW 20th St. BOCA RATON, FL 33431 (561)392-2103

SHAPE	STRENGTH	PLATING	SIZE AND DIRECTION OF MAGNETIZATION (A)
POT	N35	NiCuNi	POT B25
SIZE	PART #	DRAWING #	REVISION
A	8223	RM8223	-
SCALE 1 : 1	DRAWN: CG	CHECKED: HD	APPROVED: HD
			PAGE 1 OF 1