

# QT-Brightek UV LED Series

## UVC LED

**Part No.: QBHP684E-UV265X**

**UV265 : Wavelength  
X: 20mA or 100mA**

Product: QBHP684E-UV265 Series	Date: February 07, 2022	Page 1 of 10
	Version# 1.1	

---

**Table of Contents:**

Introduction .....	3
Electrical / Optical Characteristic (Ta=25 °C) .....	4
Absolute Maximum Rating .....	4
Characteristic Curves.....	5
IR Reflow Soldering Profile .....	7
Packing .....	8
Labeling .....	9
Caution .....	9
Ordering Information .....	9
Revision History .....	10
Disclaimer .....	10

## Introduction

### Feature:

- UVC LED
- Clear Lens
- Packed in tape and reel
- ESD rating: 8KV (HBM)
- Viewing Angle: 120° typ.

### Description:

This UV LED has compact size of 3.5 x 3.5mm. It is ideal for various UV applications.

### Application:

- UV marking
- Purification
- Inspection
- Sterilization and Disinfection

### Certification & Compliance:

- ISO9001
- RoHS Compliant



## Outline Dimensions:

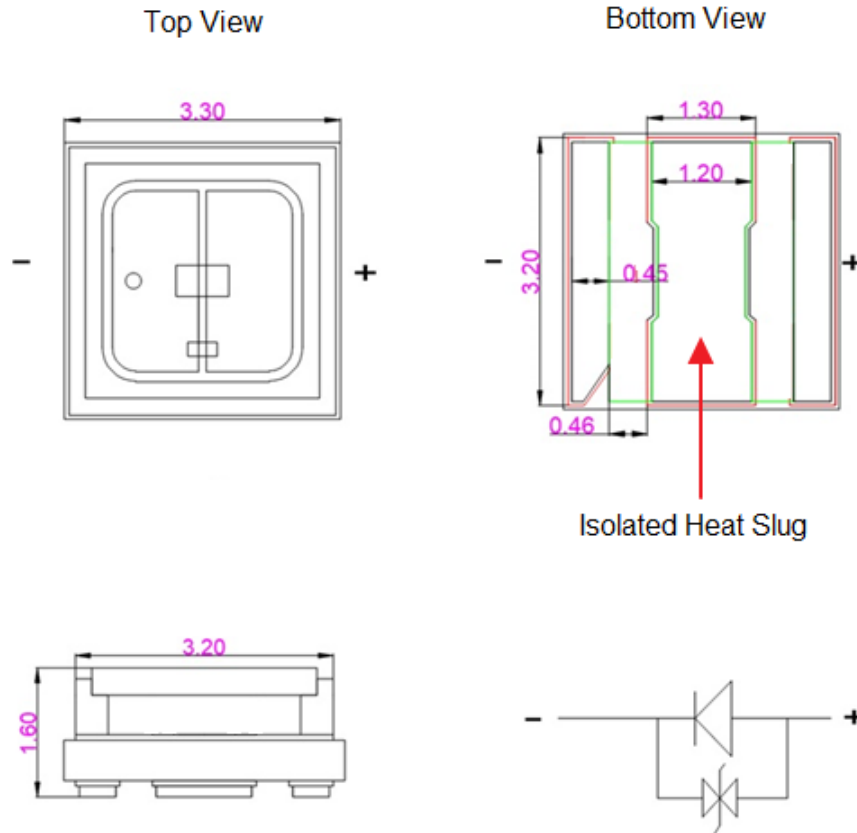

**Electrical / Optical Characteristic (Ta=25 °C)**

Part Number	Color	I <sub>F</sub> (mA)	V <sub>F</sub> (V)			λ <sub>p</sub> (nm)			P <sub>o</sub> (mW)		
			Min.	Typ.	Max.	Min.	Typ.	Max.	Min.	Typ.	Max.
QBHP684E-UV265	UVC	20	5.0	6.0	6.5	260	265	270	1.6	2.5	-
QBHP684E-UV265N	UVC	100	5.0	6.0	6.5	260	265	270	7	10	-

**Absolute Maximum Rating**

Part Number	P <sub>d</sub> (mW)	I <sub>F</sub> (mA)	T <sub>OP</sub> (°C)	T <sub>ST</sub> (°C)	T <sub>SOL</sub> (°C)
QBHP684E-UV265	260	40	-10 to +50	-40 to +100	260
QBHP684E-UV265N	1000	150	-10 to +50	-40 to +100	260

**Characteristic Curves**

QBHP684E-UV265

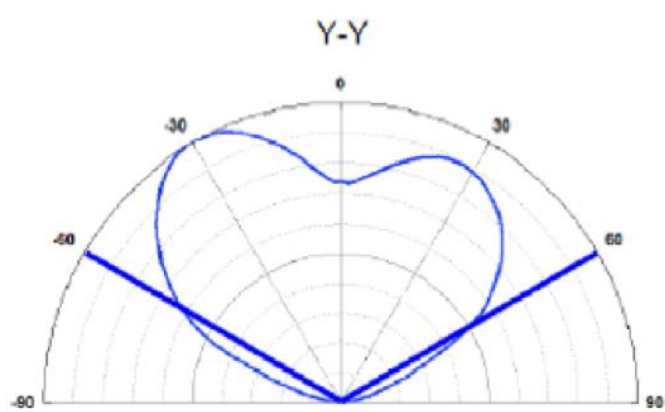
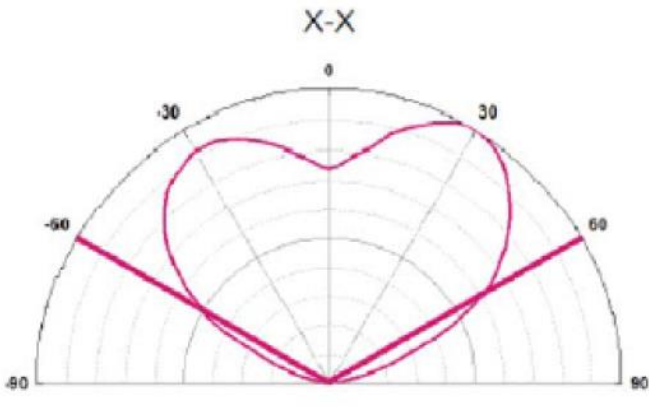
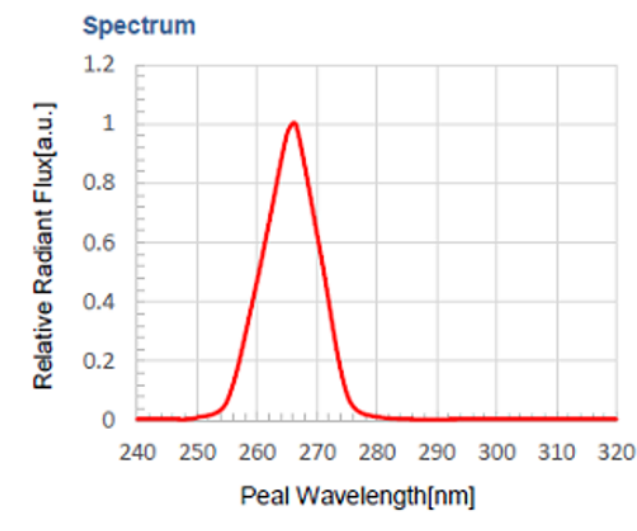
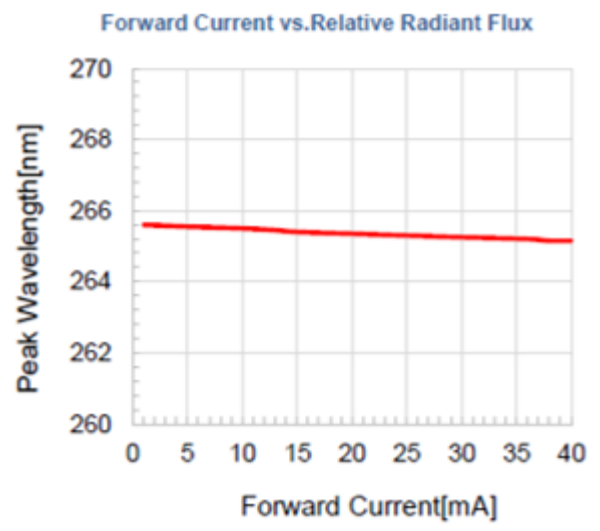
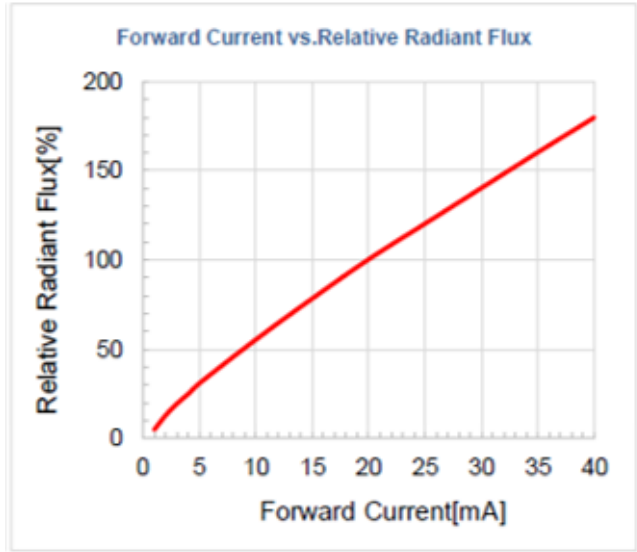
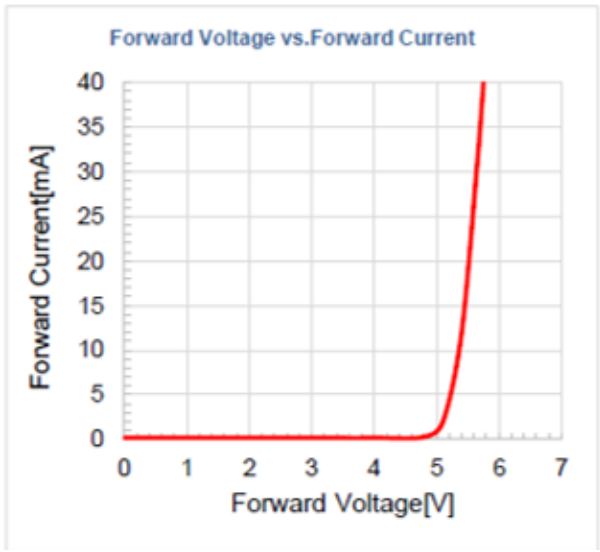

QBHP684E-UV265N

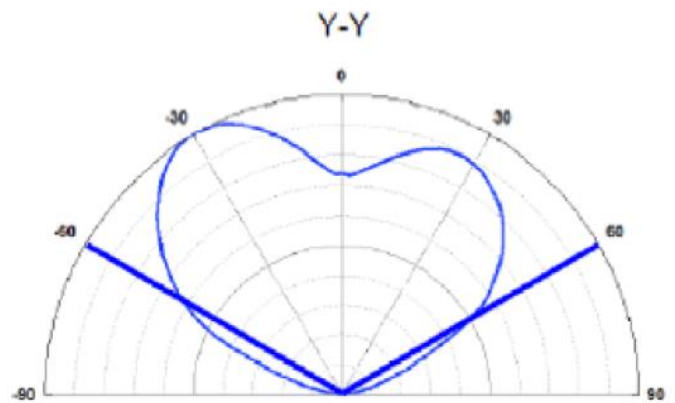
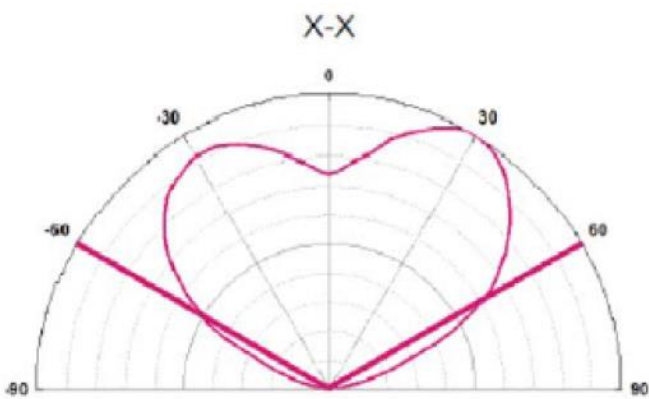
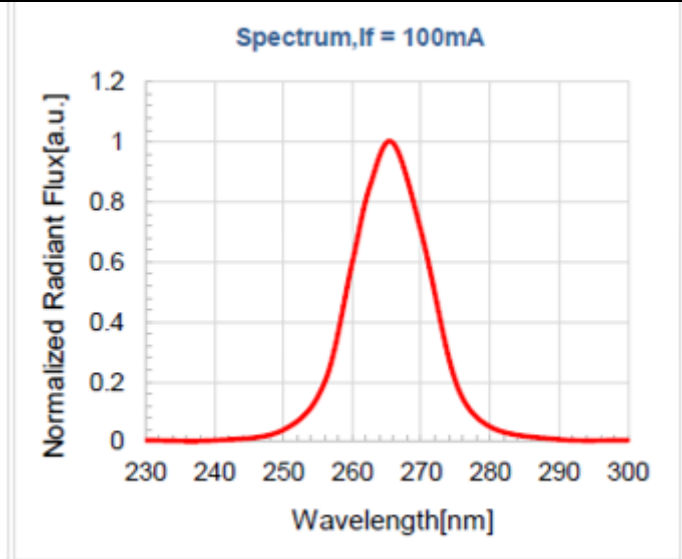
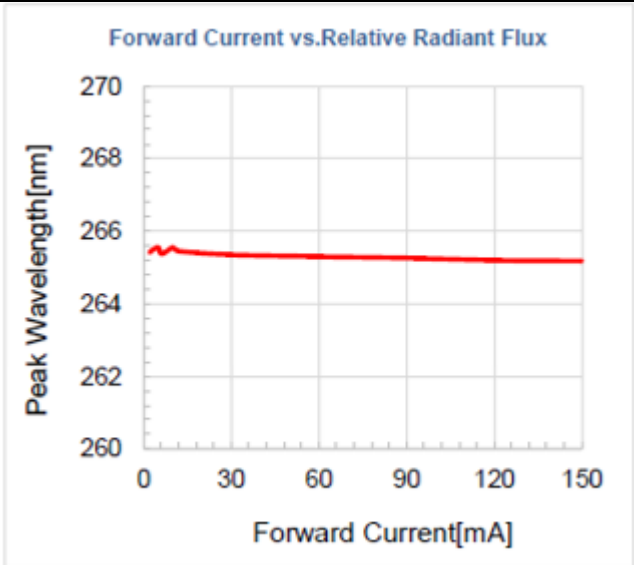
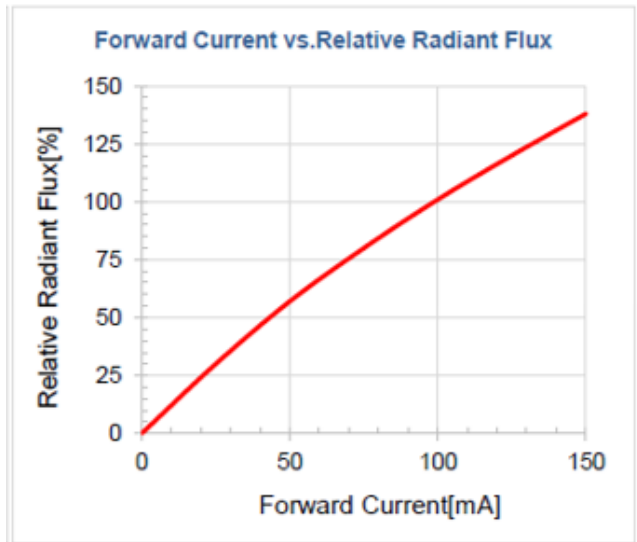
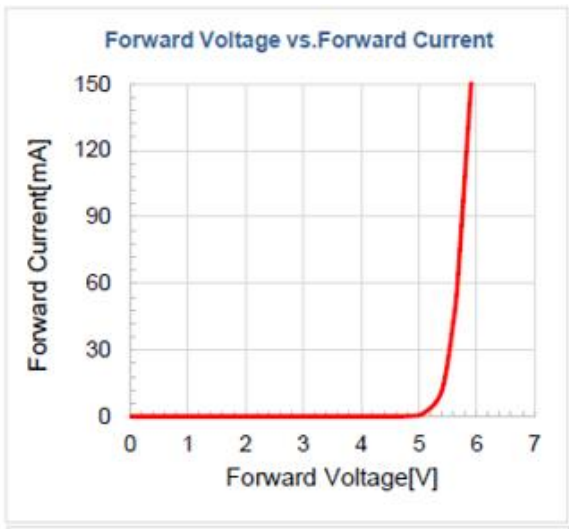

# IR Reflow Soldering Profile

## Lead Free solder

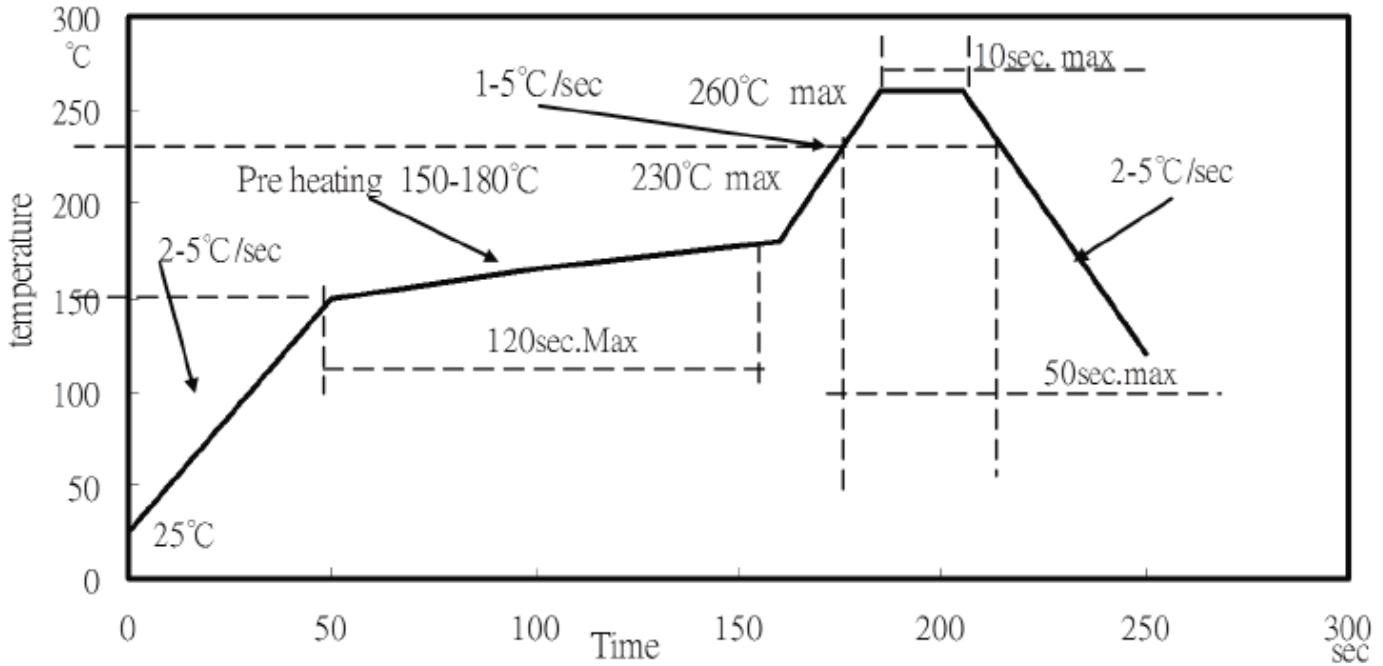

### Recommended Soldering Pad:

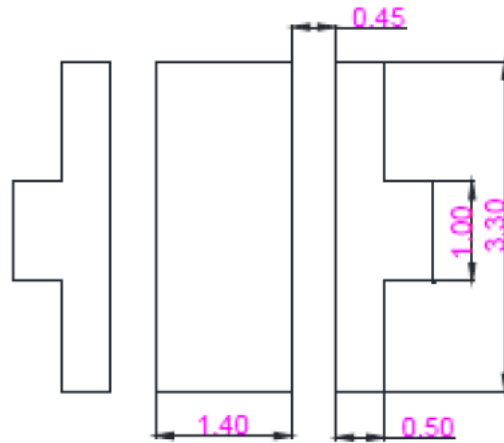

Unit: mm

## Packing

### Tape and Reel:

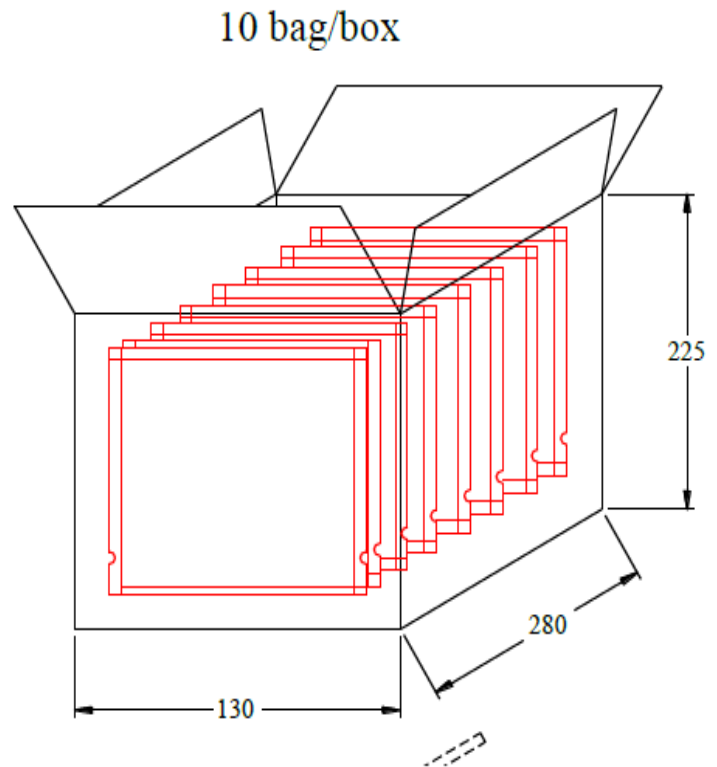
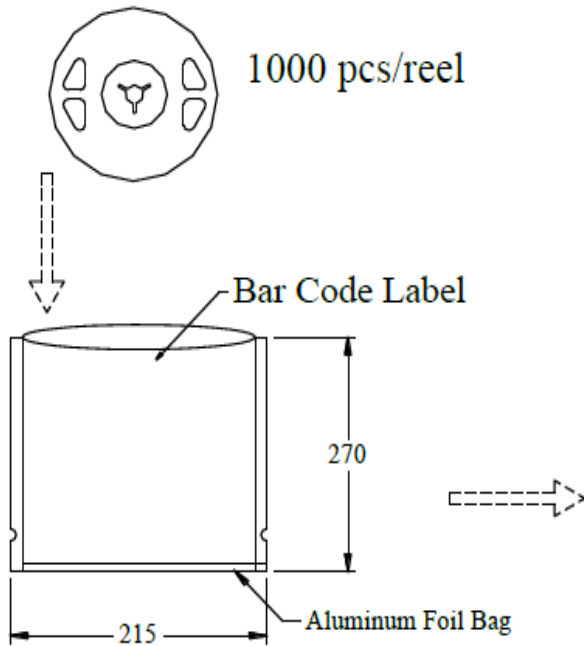
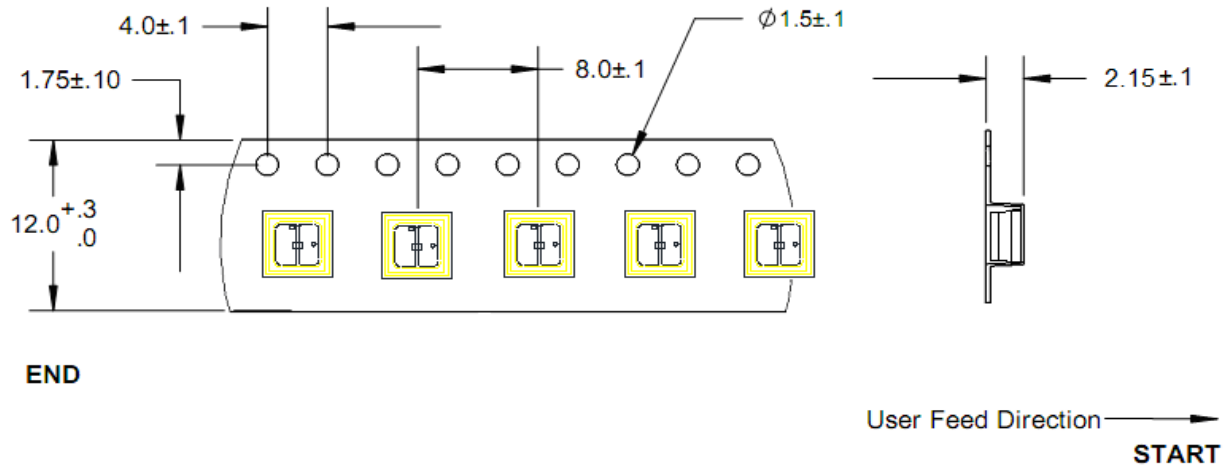



**Labeling**

Part No: \_\_\_\_\_

Customer P/N: \_\_\_\_\_

Item: \_\_\_\_\_

Q'ty: \_\_\_\_\_

Vf: \_\_\_\_\_

Iv: \_\_\_\_\_

WI: \_\_\_\_\_

Date: \_\_\_\_\_

**Made in China****Caution**

	<b>CAUTION</b>
	<ul style="list-style-type: none"> <li>• This UV LED during operation radiates intense UV light.</li> <li>• Do not look directly into the UV light during operation of the device. This can be harmful to the eyes even for brief period due to the intense UV light.</li> <li>• If viewing the UV light is necessary, please use UV filtered glasses to avoid damage by the UV light.</li> <li>• If the UV LED in your product might be viewed directly, please affix a caution label to your product to that effect.</li> </ul> <p style="text-align: center;"><b>Avoid direct eye exposure to UV light</b> <b>Keep out of reach of children</b></p>

**Ordering Information**

Part #	Orderable Part #	Spec Range	Quantity per reel
QBHP684E-UV265	QBHP684E-UV265	P <sub>o</sub> =2.5mW typ. @ I <sub>F</sub> =20mA, λ <sub>p</sub> =265nm typ.	1000 units
QBHP684E-UV265N	QBHP684E-UV265N	P <sub>o</sub> =10mW typ. @ I <sub>F</sub> =100mA, λ <sub>p</sub> =265nm typ.	1000 units

## Revision History

Description:	Revision #	Revision Date
New Release of QBHP684E-UV265 Series	V1.0	08/12/2020
Update drawing dimension	V1.1	02/07/2022

## Disclaimer

QT-BRIGHTTEK reserves the right to make changes without further notice to any products herein to improve reliability, function or design. QT-BRIGHTTEK does not assume any liability arising out of the application or use of any product or circuit described herein; neither does it convey any license under its patent rights, nor the rights of others.

## Life Support Policy

QT-BRIGHTTEK's products are not authorized for use as critical components in life support devices or systems without the express written approval of QT-BRIGHTTEK. As used herein:

1. Life support devices or systems are devices or systems which, (a) are intended for surgical implant into the body, or (b) support or sustain life, and (c) whose failure to perform when properly used in accordance with instructions for use provided in the labeling, can be reasonably expected to result in a significant injury of the user.
2. A critical component in any component of a life support device or system whose failure to perform can be reasonably expected to cause the failure of the life support device or system, or to affect its safety or effectiveness.