



## Digital Tri-axis Gyroscope/ Tri-axis Accelerometer Specifications

PART NUMBER

KXG03-1034

Rev. 2.0

14-Feb-17

### Product Description

KXG03-1034 is a 6 Degrees-of-Freedom inertial sensor system that features digital outputs accessed through I<sup>2</sup>C or SPI communication. The KXG03 sensor consists of a tri-axial micro machined gyroscope plus a tri-axial accelerometer and an KXG03 packaged in a 3 x 3 x 0.9 mm 16-pin Land Grid Array (LGA) package. The KXG03 is realized in standard CMOS technology and features flexible user programmable gyroscope full scale ranges of  $\pm 256$ ,  $\pm 512$ ,  $\pm 1024$ , and  $\pm 2048^\circ/\text{sec}$  and user-programmable  $\pm 2g/\pm 4g/\pm 8g/\pm 16g$  full scale range for the accelerometer. An auxiliary I<sup>2</sup>C master serial interface exists for communication with up to 2 other sensors to access data that can be accumulated in an internal 1024-byte FIFO buffer and transmitted to the application processor. In addition, the KXG03 has an embedded temperature sensor.

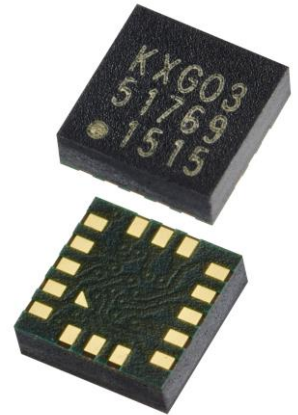

During operation, the gyroscope sensor elements are forced into vibration. When angular velocities are applied about the sensing axes, vibration is transferred to sensing elements, causing capacitance changes at the sensor electrodes. Acceleration sensing is based on the principle of a differential capacitance arising from acceleration-induced motion of the sense element, which utilizes common mode cancellation to decrease errors from process variation, temperature, and environmental stress. Capacitance changes are amplified and converted into digital signals which are processed by a dedicated digital signal processing unit. The digital signal processor applies filtering, bias and sensitivity adjustment, as well as temperature compensation. The DSP also feeds back the driving signal to ensure the proper sensor excitation.

The KXG03 series is designed to strike a balance between current consumption and noise performance with excellent bias stability over temperature. These sensors can accept supply and digital communication voltages between 1.8V and 3.6V.

|   |  |  |
|---|--|--|
|  | <b>Digital Tri-axis Gyroscope/ Tri-axis Accelerometer Specifications</b> | <b>PART NUMBER</b><br><b>KXG03-1034</b><br><b>Rev. 2.0</b><br><b>14-Feb-17</b> |
|---|--|--|

## Features

- 3 x 3 x 0.9 mm LGA
- User-selectable low power or high resolution mode
- User selectable gyroscope full scale ranges of:
  - ±256 deg/s
  - ±512 deg/s
  - ±1024 deg/s
  - ±2048 deg/s
- User selectable accelerometer full scale ranges of:
  - ±2g
  - ±4g
  - ±8g
  - ±16g
- Temperature sensor with min measurement range of -40 C to +85 C with 16-bit output
- User-selectable Output Data Rate (ODR) up to 51200Hz
- 1024 byte FIFO buffer
- Wake-up and Back-to-sleep functions
- Auxiliary I2C master interface to control up to 2 auxiliary sensors
- Independent Output Data Rate (ODR) : Over Sampling Rate (OSR) control for accelerometer
- User-configurable wake-up function
- Digital I<sup>2</sup>C up to 3.4MHz
- Digital SPI up to 10MHz
- Lead-free Solderability
- Excellent Temperature Performance
- High Shock Survivability
- Factory Programmed Offset and Sensitivity
- Self-test Function

|   |  |  |
|---|--|--|
|  | <b>Digital Tri-axis Gyroscope/ Tri-axis Accelerometer Specifications</b> | <b>PART NUMBER</b><br><b>KXG03-1034</b><br><br><b>Rev. 2.0</b><br><br><b>14-Feb-17</b> |
|---|--|--|

## Table of Contents

|   |           |
|---|-----------|
| <b>PRODUCT DESCRIPTION</b> .....                                      | <b>1</b>  |
| <b>FEATURES</b> .....   | <b>2</b>  |
| <b>TABLE OF CONTENTS</b> .....  | <b>3</b>  |
| <b>FUNCTIONAL DIAGRAM</b> .....                                       | <b>7</b>  |
| <b>PRODUCT SPECIFICATIONS</b> .....                                   | <b>8</b>  |
| GYROSCOPE MECHANICAL .....  | 8         |
| ACCELEROMETER MECHANICAL .....  | 9         |
| TEMPERATURE SENSOR .....  | 9         |
| ELECTRICAL .....  | 10        |
| <i>Accelerometer Start-up time versus ODR profile:</i> .....          | 11        |
| <i>Accelerometer Low Power Mode Current versus ODR profile:</i> ..... | 11        |
| <i>Power-On Procedure</i> .....                                       | 12        |
| ENVIRONMENTAL .....   | 13        |
| SOLDERING .....   | 13        |
| APPLICATION SCHEMATIC .....   | 14        |
| PIN DESCRIPTIONS .....  | 15        |
| PACKAGE DIMENSIONS AND ORIENTATION: .....                             | 16        |
| <i>Dimensions</i> .....   | 16        |
| <i>Orientation</i> .....  | 17        |
| <b>DIGITAL INTERFACE</b> .....  | <b>18</b> |
| I <sup>2</sup> C SERIAL INTERFACE .....                               | 18        |
| <i>I<sup>2</sup>C Operation</i> .....                                 | 19        |
| <i>Writing to 8-bit Register</i> .....                                | 20        |
| <i>Reading from 8-bit Register</i> .....                              | 21        |
| <i>Data Transfer Sequences</i> .....                                  | 22        |
| <i>HS-mode</i> .....  | 23        |
| <i>I<sup>2</sup>C Timing Diagram</i> .....                            | 24        |
| <i>I<sup>2</sup>C Timing Specifications</i> .....                     | 24        |
| <i>Auxiliary I<sup>2</sup>C Operation</i> .....                       | 25        |
| <i>Auxiliary I<sup>2</sup>C Host Mode</i> .....                       | 25        |
| <i>Auxiliary I<sup>2</sup>C Bypass Mode</i> .....                     | 25        |
| <i>Internal Pull-up Resistor</i> .....                                | 25        |
| SPI COMMUNICATIONS .....  | 26        |
| <i>4-Wire SPI Interface</i> .....                                     | 26        |
| <i>4-Wire SPI Timing Diagram</i> .....                                | 27        |
| <i>4-Wire Read and Write Registers</i> .....                          | 28        |
| <b>POWER MODES</b> .....  | <b>29</b> |



# Digital Tri-axis Gyroscope/ Tri-axis Accelerometer Specifications

PART NUMBER

KXG03-1034

Rev. 2.0

14-Feb-17

|  |           |
|--|-----------|
| OFF MODE .....   | 29        |
| INITIAL STARTUP.....                                     | 29        |
| STAND-BY MODE .....                                      | 30        |
| ACTIVE WUF MODE.....                                     | 30        |
| ACTIVE WAKE AND SLEEP MODE.....                          | 30        |
| <b>EMBEDDED WAKE-UP AND BACK-TO-SLEEP FUNCTION .....</b> | <b>31</b> |
| <b>EMBEDDED REGISTERS.....</b>                           | <b>32</b> |
| GYROSCOPE OUTPUTS .....                                  | 33        |
| ACCELEROMETER OUTPUTS .....                              | 33        |
| TEMPERATURE SENSOR OUTPUTS .....                         | 34        |
| <b>REGISTER DESCRIPTIONS.....</b>                        | <b>35</b> |
| TEMP_OUT.....  | 35        |
| GYRO_XOUT.....   | 35        |
| GYRO_YOUT.....   | 35        |
| GYRO_ZOUT.....   | 35        |
| ACCEL_XOUT.....  | 36        |
| ACCEL_YOUT.....  | 36        |
| ACCEL_ZOUT.....  | 36        |
| AUX1_OUT .....   | 36        |
| AUX2_OUT .....   | 37        |
| WAKE_CNT.....  | 37        |
| SLEEP_CNT .....  | 37        |
| BUF_SMPLEV .....   | 38        |
| BUF_PAST .....   | 38        |
| AUX_STATUS.....  | 38        |
| WHO_AM_I.....  | 40        |
| SN.....  | 40        |
| STATUS1.....   | 40        |
| INT1_SRC1 .....  | 42        |
| INT1_SRC2 .....  | 43        |
| INT1_L.....  | 44        |
| STATUS2.....   | 44        |
| INT2_SRC1 .....  | 45        |
| INT2_SRC2 .....  | 47        |
| INT2_L.....  | 48        |
| ACCEL_ODR_WAKE.....                                      | 48        |
| ACCEL_ODR_SLEEP .....                                    | 49        |
| ACCEL_CTL .....  | 51        |
| GYRO_ODR_WAKE.....                                       | 51        |
| GYRO_ODR_SLEEP .....                                     | 53        |
| STDBY.....   | 55        |



# Digital Tri-axis Gyroscope/ Tri-axis Accelerometer Specifications

**PART NUMBER**

**KXG03-1034**

**Rev. 2.0**

**14-Feb-17**

|  |           |
|--|-----------|
| CTL_REG_1.....                                 | 56        |
| INT_PIN_CTL.....                               | 57        |
| INT_PIN1_SEL.....                              | 58        |
| INT_PIN2_SEL.....                              | 59        |
| INT_MASK1.....                                 | 60        |
| INT_MASK2.....                                 | 61        |
| FSYNC_CTL.....                                 | 61        |
| WAKE_SLEEP_CTL1.....                           | 62        |
| WAKE_SLEEP_CTL2.....                           | 63        |
| WUF_TH.....                                    | 63        |
| WUF_COUNTER.....                               | 64        |
| BTS_TH.....                                    | 64        |
| BTS_COUNTER.....                               | 64        |
| AUX_I2C_CTL_REG.....                           | 65        |
| AUX_I2C_SAD1.....                              | 66        |
| AUX_I2C_REG1.....                              | 66        |
| AUX_I2C_CTL1.....                              | 66        |
| AUX_I2C_BIT1.....                              | 66        |
| AUX_I2C_ODR1_W.....                            | 67        |
| AUX_I2C_ODR1_S.....                            | 68        |
| AUX_I2C_SAD2.....                              | 68        |
| AUX_I2C_REG2.....                              | 69        |
| AUX_I2C_CTL2.....                              | 69        |
| AUX_I2C_BIT2.....                              | 69        |
| AUX_I2C_ODR2_W.....                            | 69        |
| AUX_I2C_ODR2_S.....                            | 71        |
| BUF_WMITH_L.....                               | 71        |
| BUF_WMITH_H.....                               | 72        |
| BUF_TRIGTH_L.....                              | 72        |
| BUF_TRIGTH_H.....                              | 72        |
| BUF_CTL2.....                                  | 73        |
| BUF_CTL3.....                                  | 73        |
| BUF_CTL4.....                                  | 74        |
| BUF_EN.....                                    | 74        |
| BUF_STATUS.....                                | 76        |
| BUF_CLEAR.....                                 | 76        |
| BUF_READ.....                                  | 76        |
| <b>SAMPLE BUFFER FEATURE DESCRIPTION .....</b> | <b>77</b> |
| FIFO MODE.....                                 | 77        |
| STREAM MODE.....                               | 77        |
| TRIGGER MODE.....                              | 78        |
| FILO MODE.....                                 | 78        |

|   |  |  |
|---|--|--|
|  | <p align="center"><b>Digital Tri-axis Gyroscope/ Tri-axis Accelerometer Specifications</b></p> | <p align="center"><b>PART NUMBER</b><br/>KXG03-1034<br/>Rev. 2.0<br/>14-Feb-17</p> |
|---|--|--|

BUFFER OPERATION ..... 78  
 SYNCHRONIZING BUFFER UPDATES TO EXTERNAL CLOCK ..... 84  
 EXTERNAL INTERRUPT SAMPLING ..... 84  
 INPUT DATA SELECT ..... 84  
 DATA ORDER ..... 84  
 BUFFER UPDATE RATE ..... 85  
 BUFFER SIZE DESCRIPTION ..... 85  
 BUFFER FULL INTERRUPT (BFI) ..... 86  
 SMP\_PAST COUNTER (PACKETS LOST SINCE BFI) ..... 87  
 WATERMARK (WMI) ..... 87  
 BUFFER LEVEL ..... 87  
 CHANGING BUFFER CONFIGURATIONS ..... 88  
 CHANGING SENSOR CONFIGURATIONS ..... 88  
 CLEARING THE BUFFER ..... 88  
 BUFFER READS ..... 88  
**REVISION HISTORY ..... 89**  
**APPENDIX ..... 89**



# Digital Tri-axis Gyroscope/ Tri-axis Accelerometer Specifications

**PART NUMBER**  
**KXG03-1034**  
 Rev. 2.0  
 14-Feb-17

## Functional Diagram

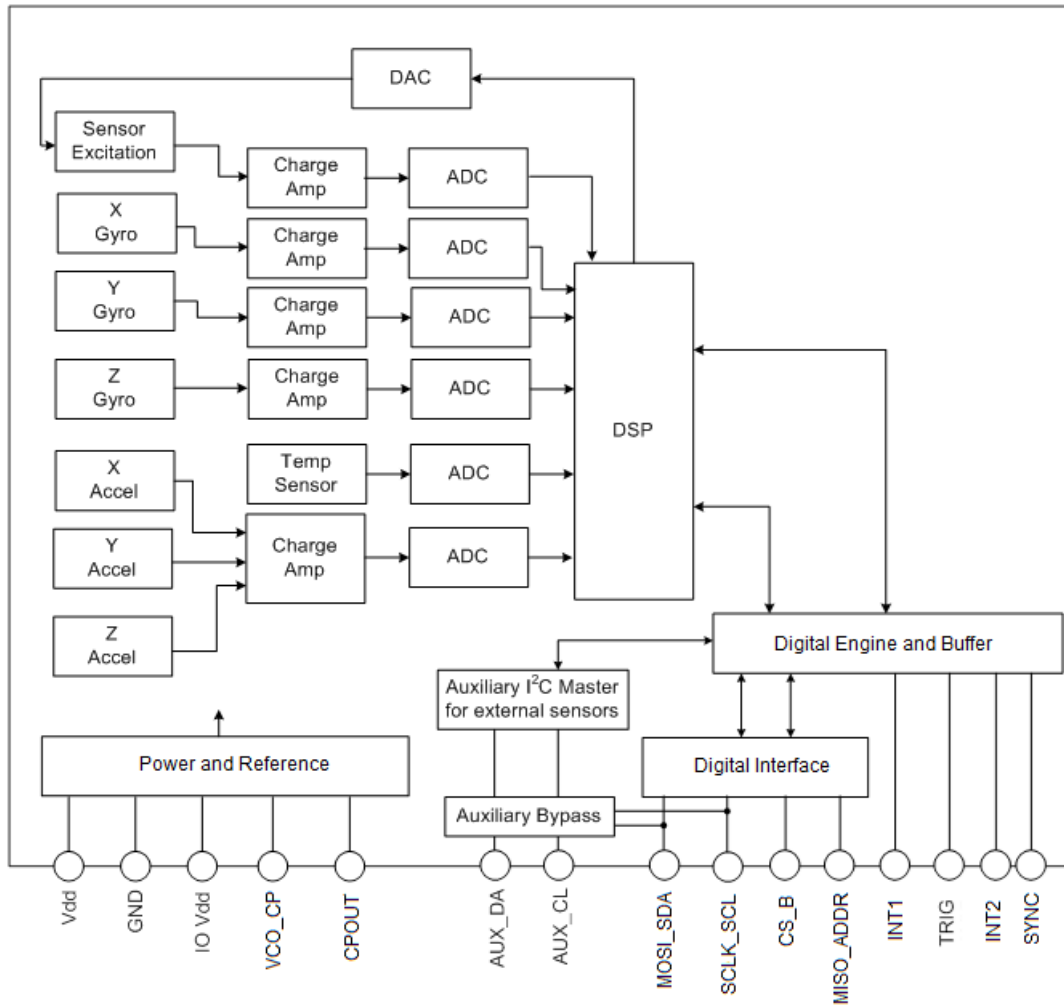



# Digital Tri-axis Gyroscope/ Tri-axis Accelerometer Specifications

**PART NUMBER**

**KXG03-1034**

**Rev. 2.0**

**14-Feb-17**

## Product Specifications

### Gyroscope Mechanical

(Specifications are for operation at VDD = 2.5V and T = 25°C unless stated otherwise)

| Parameters                                  |                                     | Units          | Min | Typical | Max |
|---|-------------------------------------|----------------|-----|---------|-----|
| Operating Temperature Range                 |                                     | °C             | -40 | -       | 85  |
| Zero Rate Output, Digital                   |                                     | counts         |     | 0       |     |
| Zero Rate Output Stability                  |                                     | ± % of FS      |     | 1       |     |
| Zero Rate Output Variation over Temperature |                                     | ± dps / °C     |     | 0.4     |     |
| Sensitivity (16-bit) <sup>1</sup>           | RSEL1 = 0, RSEL0 = 0, ±256 deg/sec  | counts/deg/sec |     | 128     |     |
|   | RSEL1 = 0, RSEL0 = 1, ±512 deg/sec  |                |     | 64      |     |
|   | RSEL1 = 1, RSEL0 = 0, ±1024 deg/sec |                |     | 32      |     |
|   | RSEL1 = 1, RSEL0 = 1, ±2048 deg/sec |                |     | 16      |     |
| Sensitivity Variation over Temperature      |                                     | ± % / °C       |     | 0.04    |     |
| Noise Density                               |                                     | deg/sec/√Hz    |     | 0.03    |     |
| Output Noise (10 Hz BW)                     |                                     | dps-rms        |     | 0.096   |     |
| Non-Linearity                               |                                     | % of FS        |     | 0.5     |     |
| Cross Axis Sensitivity                      |                                     | ± %            |     | 1       |     |
| Bandwidth <sup>2</sup>                      |                                     | Hz             | 10  |         | 160 |

**Table 1:** Gyroscope Mechanical Specifications

Notes:

1. Resolution and rotation rate ranges are user selectable.
2. User selectable via control register.





# Digital Tri-axis Gyroscope/ Tri-axis Accelerometer Specifications

**PART NUMBER**

**KXG03-1034**

**Rev. 2.0**

**14-Feb-17**

## Accelerometer Mechanical

(Specifications are for operation at VDD = 2.5V and T = 25°C unless stated otherwise)

| Parameters                                 | Units                            | Min   | Typical               | Max   |
|--|----------------------------------|-------|-----------------------|-------|
| Operating Temperature Range                | °C                               | -40   | -                     | 85    |
| Zero-g Offset                              | mg                               | -     | ±25                   | ±125  |
| Zero-g Offset Variation from RT over Temp. | ± mg/ °C                         |       | 0.25                  |       |
| Sensitivity (16-bit) <sup>1</sup>          | GSEL1=1, GSEL0=1 (± 2g)          | 15565 | 16384                 | 17203 |
|  | GSEL1=0, GSEL0=0 (± 4g)          | 7782  | 8192                  | 8602  |
|  | GSEL1=0, GSEL0=1 (± 8g)          | 3891  | 4096                  | 4301  |
|  | GSEL1=1, GSEL0=0 (± 16g)         | 1946  | 2048                  | 2150  |
| Sensitivity Variation from RT over Temp.   | ± % / °C                         |       | 0.01 (xy)<br>0.03 (z) |       |
| Self-Test Output                           | g                                |       | 0.5                   |       |
| Mechanical Resonance (-3dB) <sup>2</sup>   | Hz                               |       | 3500 (xy)<br>1800 (z) |       |
| Non-Linearity                              | % of FS                          |       | 0.5                   |       |
| Cross Axis Sensitivity                     | %                                |       | 2                     |       |
| Noise Density                              | $\mu\text{g} / \sqrt{\text{Hz}}$ |       | 175                   |       |
| Bandwidth (-3dB)                           | Hz                               |       | ODR/2                 |       |

**Table 2:** Accelerometer Mechanical Specifications

Notes:

1. Resolution and acceleration ranges are user selectable.
2. Resonance as defined by the damped mechanical sensor.

## Temperature Sensor

(Specifications are for operation at VDD = 2.5V and T = 25 °C unless stated otherwise)

| Parameters                   | Units      | Min | Typical | Max |
|------------------------------|------------|-----|---------|-----|
| Operating Temperature Range  | °C         | -40 | -       | 85  |
| Output Accuracy              | ± °C       |     | 3       |     |
| Sensitivity (16-bit digital) | counts/ °C |     | 128     |     |

**Table 3:** Temperature Sensor Specifications



# Digital Tri-axis Gyroscope/ Tri-axis Accelerometer Specifications

**PART NUMBER**

**KXG03-1034**

**Rev. 2.0**

**14-Feb-17**

## Electrical

(Specifications are for operation at VDD = 2.5V and T = 25 °C unless stated otherwise)

| Parameters   |  | Units | Min          | Typical | Max          |
|--|--|-------|--------------|---------|--------------|
| Supply Voltage (VDD)                               | Operating                                      | V     | 1.8          | 2.5     | 3.6          |
| I/O Pads Supply Voltage (IO_VDD)                   |  | V     | 1.7          |         | VDD          |
| Current Consumption                                | Operating (gyroscope + accelerometer)          | mA    |              | 2.1     |              |
|  | Gyroscope only                                 | mA    |              | 1.85    |              |
|  | Accelerometer only High Res Mode               | µA    |              | 325     |              |
|  | Accelerometer only Low Power Mode <sup>6</sup> | µA    |              | 5       |              |
|  | Standby  | µA    |              | 1.5     |              |
| Output Low Voltage <sup>1</sup> (VOL)              |  | V     | -            | -       | 0.3 * IO_VDD |
| Output High Voltage (VOH)                          |  | V     | 0.9 * IO_VDD | -       | -            |
| Input Low Voltage (VIL)                            |  | V     | -            | -       | 0.2 * IO_VDD |
| Input High Voltage (VIH)                           |  | V     | 0.8 * IO_VDD | -       | -            |
| Power Up Time (Power on Reset Time) <sup>2</sup>   |  | ms    |              |         | 50           |
| Software Reset <sup>7</sup>                        |  | ms    |              |         | 2            |
| Sensor Start-Up Time <sup>3</sup>                  | Gyroscope                                      | ms    |              | 80      |              |
|  | Accelerometer (100Hz)                          | ms    |              | 20      |              |
| I <sup>2</sup> C Communication Rate <sup>4,5</sup> |  | MHz   |              |         | 3.4          |
| I <sup>2</sup> C Address                           |  |       |              | 4E / 4F |              |
| SPI communication Rate                             |  | MHz   |              |         | 10           |

**Table 4: Electrical Specifications**

### Notes:

1. Assuming I<sup>2</sup>C communication and minimum 1.5kΩ pull-up resistor on SCL and SDA.
2. From OFF to Standby mode after VDD and IO\_VDD are valid
3. Time from sensor standby mode to operating mode (GYRO\_RUN = 1). Accelerometer time varies with accelerometer Output Data Rate (ODR) per table below.
4. Assuming max bus capacitance load of 20pF.
5. The I<sup>2</sup>C bus supports Standard-Mode, Fast-Mode and High Speed Mode.
6. Accelerometer only in Low Power Mode current varies with accelerometer Output Data Rate (ODR) and Output Wake-up Function (OWUF) per figure on the next page.
7. Software Reset Time is defined as the time it takes to perform a RAM reboot routine following the setting of the SRST bit to 1 in the CTL\_REG\_1 register. The SRST bit will remain 1 until the RAM reboot routine is completed.



# Digital Tri-axis Gyroscope/ Tri-axis Accelerometer Specifications

**PART NUMBER**  
KXG03-1034  
Rev. 2.0  
14-Feb-17

## Accelerometer Start-up time versus ODR profile:

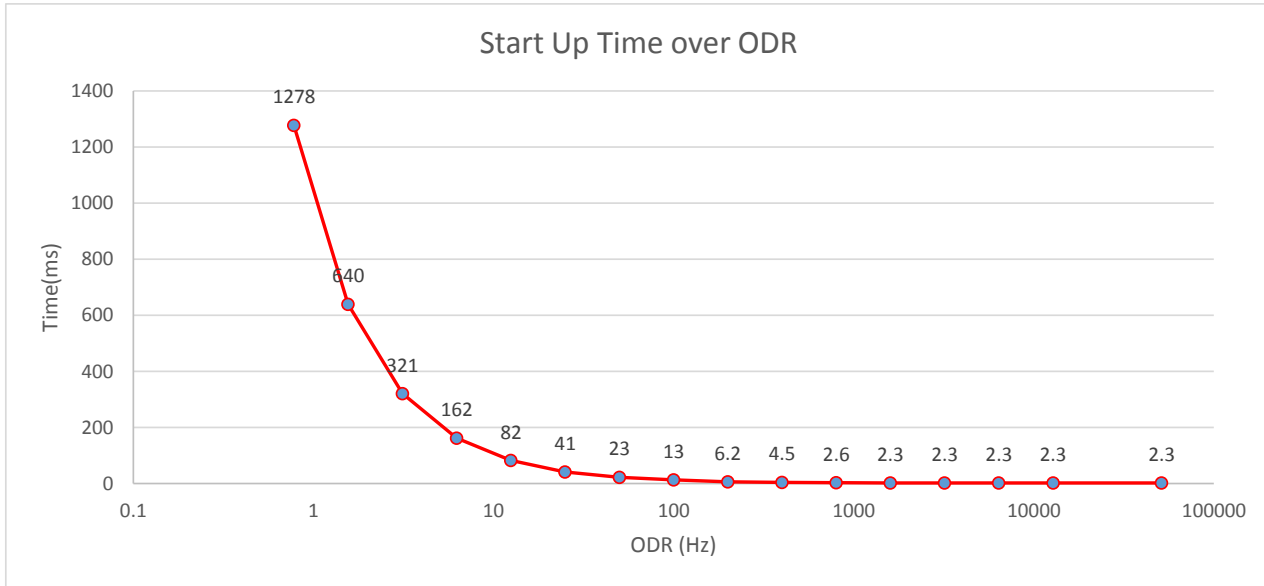

## Accelerometer Low Power Mode Current versus ODR profile:

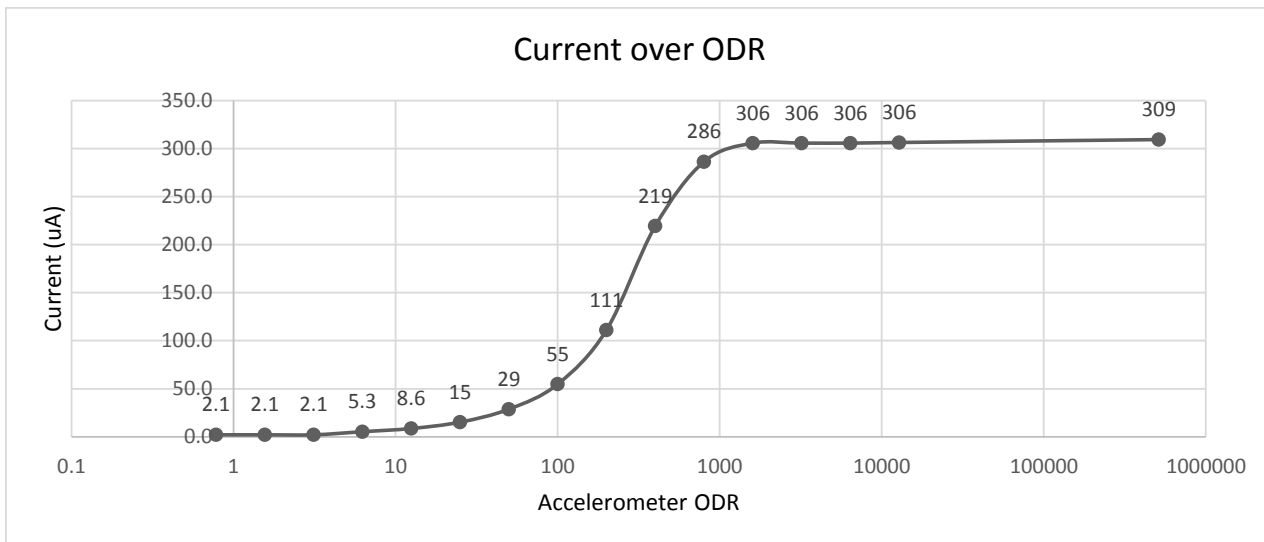

|   |  |   |
|---|--|---|
|  | <b>Digital Tri-axis Gyroscope/ Tri-axis Accelerometer Specifications</b> | <b>PART NUMBER</b><br>KXG03-1034<br>Rev. 2.0<br>14-Feb-17 |
|---|--|---|

### Power-On Procedure

Proper functioning of power-on reset (POR) is dependent on the specific **VDD**, **VDD<sub>Low</sub>**, **T<sub>VDD</sub>** (rise time), and **T<sub>VDD\_OFF</sub>** profile of individual applications. It is recommended to minimize **VDD<sub>Low</sub>**, and **T<sub>VDD</sub>**, and maximize **T<sub>VDD\_OFF</sub>**. It is also advised that the **VDD** ramp up time **T<sub>VDD</sub>** be monotonic. Note that the outputs will not be stable until **VDD** has reached its final value.

- ! *To assure proper POR, the application should be evaluated over the customer specified range of VDD, VDD<sub>Low</sub>, T<sub>VDD</sub>, T<sub>VDD\_OFF</sub> and temperature as POR performance can vary depending on these parameters.*

Please refer to Technical Note [TN022 Power-On Procedure](#) for more information.

|   |  |                    |
|---|--|--------------------|
|  | <b>Digital Tri-axis Gyroscope/ Tri-axis Accelerometer Specifications</b> | <b>PART NUMBER</b> |
|   |  | <b>KXG03-1034</b>  |
|   |  | <b>Rev. 2.0</b>    |
|   |  | <b>14-Feb-17</b>   |

**Environmental**

| Parameters                          |                 | Units | Min  | Typical | Max                                 |
|-------------------------------------|-----------------|-------|------|---------|-------------------------------------|
| Supply Voltage (VDD)                | Absolute Limits | V     | -0.3 | -       | 3.6                                 |
| Operating Temperature Range         |                 | °C    | -40  | -       | 85                                  |
| Storage Temperature Range           |                 | °C    | -55  | -       | 150                                 |
| Mech. Shock (powered and unpowered) |                 | g     | -    | -       | 5000 for 0.5 ms<br>10000 for 0.2 ms |
| ESD                                 | HBM             | V     | -    | -       | 2000                                |

**Table 5:** Environmental Specifications



Caution: ESD Sensitive and Mechanical Shock Sensitive Component, improper handling can cause permanent damage to the device.



These products conform to RoHS Directive 2011/65/EU of the European Parliament and of the Council of the European Union that was issued June 8, 2011. Specifically, these products do not contain any non-exempted amounts of lead, mercury, cadmium, hexavalent chromium, polybrominated biphenyls (PBB) or polybrominated diphenyl ethers (PBDE) above the maximum concentration values (MCV) by weight in any of its homogenous materials. Homogenous materials are “of uniform composition throughout”. The MCV for lead, mercury, hexavalent chromium, PBB, and PBDE is 0.10%. The MCV for cadmium is 0.010%.

Applicable Exemption: *7C-1 - Electrical and electronic components containing lead in a glass or ceramic other than dielectric ceramic in capacitors (piezoelectronic devices) or in a glass or ceramic matrix compound.*



These products are also in conformance with REACH Regulation No 1907/2006 of the European Parliament and of the Council that was issued Dec. 30, 2011. They do not contain any Substances of Very High Concern (SVHC-161) as identified by the European Chemicals Agency as of 17 December 2014.



This product is halogen-free per IEC 61249-2-21. Specifically, the materials used in this product contain a maximum total halogen content of 1500 ppm with less than 900-ppm bromine and less than 900-ppm chlorine.

**Soldering**

Soldering recommendations are available upon request or from [www.kionix.com](http://www.kionix.com).



# Digital Tri-axis Gyroscope/ Tri-axis Accelerometer Specifications

**PART NUMBER**  
**KXG03-1034**  
 Rev. 2.0  
 14-Feb-17

## Application Schematic

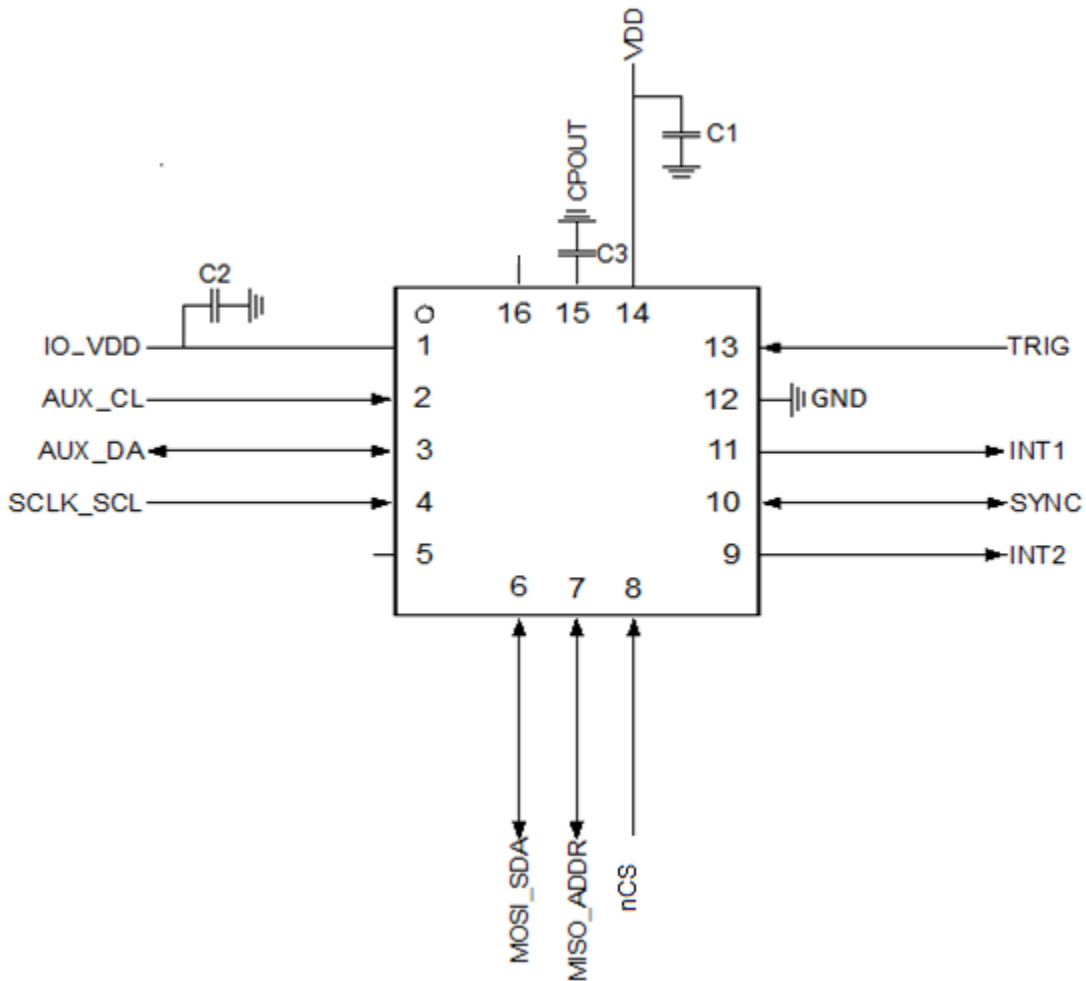

| ID | Stress | Value       | Rating | Type |
|----|--------|-------------|--------|------|
| C1 | 3 V    | 0.1 $\mu$ F | 16 V   | Y5V  |
| C2 | 3 V    | 0.1 $\mu$ F | 16 V   | Y5V  |
| C3 | 20 V   | 2.2 nF      | 50 V   | Y5V  |



# Digital Tri-axis Gyroscope/ Tri-axis Accelerometer Specifications

PART NUMBER

KXG03-1034

Rev. 2.0

14-Feb-17

## Pin Descriptions

| Pin | Name                  | Description  |
|-----|-----------------------|--|
| 1   | IO_VDD                | External supply for IO ring. Connect bypass capacitor C2   |
| 2   | AUX_CL <sup>4</sup>   | Auxiliary I <sup>2</sup> C master serial clock   |
| 3   | AUX_DA <sup>4</sup>   | Auxiliary I <sup>2</sup> C master serial data  |
| 4   | SCLK_SCL <sup>1</sup> | SPI/I <sup>2</sup> C serial clock  |
| 5   | RESERVED              | Connect to GND or leave floating. Do not connect to IO_VDD.  |
| 6   | MOSI_SDA <sup>2</sup> | SPI MOSI / I <sup>2</sup> C serial data  |
| 7   | MISO_ADDR             | Serial data input during 4-wire SPI communication and part of the device address during I <sup>2</sup> C communication.      |
| 8   | nCS                   | Chip Select (active LOW) for SPI communication. Connect to IO_VDD for I <sup>2</sup> C communication. Do not leave floating. |
| 9   | INT2                  | Programmable interrupt output. Leave floating if not used.   |
| 10  | SYNC <sup>3</sup>     | Sync input or output. If configured as input, connect to IO_VDD or GND. If configured as output, leave floating.             |
| 11  | INT1                  | Programmable interrupt output. Leave floating if not used.   |
| 12  | GND                   | Ground   |
| 13  | TRIG                  | External trigger input for buffer actions. Connect to IO_VDD or GND if unused.   |
| 14  | VDD                   | External supply with bypass capacitor C1   |
| 15  | CPOUT                 | External charge pump reservoir cap C3  |
| 16  | RESERVED              | Connect to GND or leave floating   |

Table 6: Pin Descriptions

### Notes:

- 1, 2 For I<sup>2</sup>C communication, connect an external IO\_VDD pull-up resistors on SCL (pin 4) and SDA (pin 6). The value of the pull up resistors should be 1.5 k $\Omega$  or above to ensure a V<sub>OL</sub> that is less than the maximum specified value.
- 3 Care must be taken with external connection of the SYNC pin. The reset state of the SYNC pin is tri-stated. If pin is not used in application, connect to IO\_VDD or GND and ensure the state of the pin is never changed to output through register write to FSYNC\_CTL register. If pin is configured as Output in the application, the pin must be left floating to avoid internal short circuit to IO\_VDD or GND.
- 4 The AUX\_DA and AUX\_CL pins should be left floating for applications that do not use the auxiliary I<sup>2</sup>C interface. Applications interfacing to the sensor in I<sup>2</sup>C mode and not using aux I<sup>2</sup>C can keep the default aux\_bypass=1 and aux\_pull\_up=0 settings (see AUX\_I2C\_CTL\_REG). Applications trying to limit the main I<sup>2</sup>C bus capacitance should set aux\_bypass=0 and aux\_pull\_up=1. Applications interfacing to the sensor in SPI mode and not using aux I<sup>2</sup>C should set bypass=0 and pull\_up=1. Please note SPI applications may see increased standby current until aux\_bypass and aux\_pull\_up have been changed from the default settings.



# Digital Tri-axis Gyroscope/ Tri-axis Accelerometer Specifications

**PART NUMBER**  
**KXG03-1034**  
 Rev. 2.0  
 14-Feb-17

## Package Dimensions and Orientation:

### Dimensions

3 x 3 x 0.9 mm LGA Dimensions

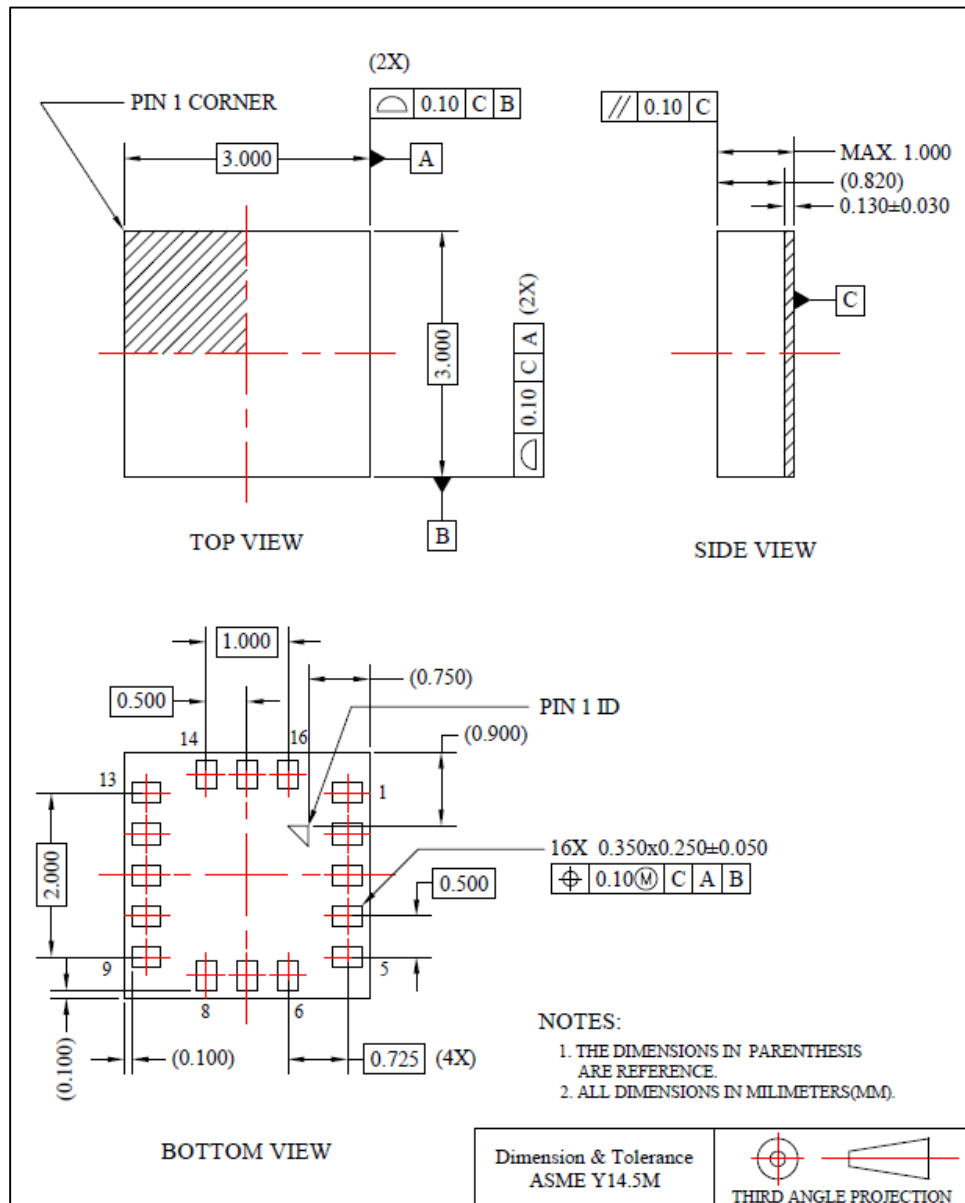

**Figure 1: Package Dimensions**





# Digital Tri-axis Gyroscope/ Tri-axis Accelerometer Specifications

PART NUMBER  
KXG03-1034  
Rev. 2.0  
14-Feb-17

## Orientation

When the device is accelerated or rotated in +X, +Y, or +Z direction, the corresponding output will increase.

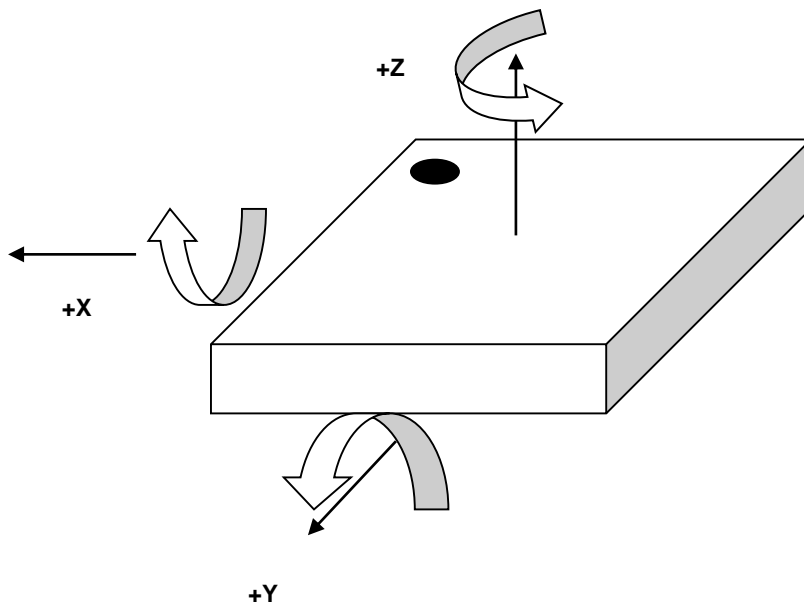



Figure 2: Device Orientation

|   |  |  |
|---|--|--|
|  | <b>Digital Tri-axis Gyroscope/ Tri-axis Accelerometer Specifications</b> | <b>PART NUMBER</b><br><b>KXG03-1034</b><br><b>Rev. 2.0</b><br><b>14-Feb-17</b> |
|---|--|--|

## Digital Interface

The Kionix KXG03 digital sensor has the ability to communicate via the I<sup>2</sup>C and SPI digital serial interface protocols. This allows for easy system integration by eliminating analog-to-digital converter requirements and by providing direct communication with system micro-controllers.

The serial interface terms and descriptions as indicated in the table below will be observed throughout this document.

| Term        | Description   |
|-------------|---|
| Transmitter | The device that transmits data to the bus.  |
| Receiver    | The device that receives data from the bus.   |
| Master      | The device that initiates a transfer, generates clock signals, and terminates a transfer. |
| Slave       | The device addressed by the Master.   |

**Table 7:** Serial Interface Terminologies

## I<sup>2</sup>C Serial Interface

As previously mentioned, the KXG03 has the ability to communicate on an I<sup>2</sup>C bus. I<sup>2</sup>C is primarily used for synchronous serial communication between a Master device and one or more Slave devices. The Master, typically a micro controller, provides the serial clock signal and addresses Slave devices on the bus. The KXG03 always operates as a Slave device during standard Master-Slave I<sup>2</sup>C operation.

I<sup>2</sup>C is a two-wire serial interface that contains a Serial Clock (SCL) line and a Serial Data (SDA) line. SCL is a serial clock that is provided by the Master, but can be held low by any Slave device, putting the Master into a wait condition. SDA is a bi-directional line used to transmit and receive data to and from the interface. Data is transmitted MSB (Most Significant Bit) first in 8-bit per byte format, and the number of bytes transmitted per transfer is unlimited. The I<sup>2</sup>C bus is considered free when both lines are high.

The I<sup>2</sup>C interface is compliant with high-speed mode, fast mode and standard mode I<sup>2</sup>C protocols.



# Digital Tri-axis Gyroscope/ Tri-axis Accelerometer Specifications

**PART NUMBER**

**KXG03-1034**

**Rev. 2.0**

**14-Feb-17**

## I<sup>2</sup>C Operation

Transactions on the I<sup>2</sup>C bus begin after the Master transmits a start condition (S), which is defined as a high-to-low transition on the data line while the SCL line is held high. The bus is considered busy after this condition. The next byte of data transmitted after the start condition contains the Slave Address (SAD) in the seven MSBs (Most Significant Bits), and the LSB (Least Significant Bit) tells whether the Master will be receiving data '1' from the Slave or transmitting data '0' to the Slave. When a Slave Address is sent, each device on the bus compares the seven MSBs with its internally stored address. If they match, the device considers itself addressed by the Master. The KXG03 Slave Address is comprised of a user programmable part, a factory programmable part, and a fixed part, which allows for connection of multiple sensors to the same I<sup>2</sup>C bus. The Slave Address associated with the KXG03 is 10011YX, where the user programmable bit X, is determined by the assignment of MISO\_ADDR (pin 7) to GND or IO\_VDD. Also, the factory programmable bit Y is set at the factory. For KXG03-1034, the factory programmable bit Y is fixed to 1 (contact your Kionix sales representative for list of available devices). Table 8 lists possible I<sup>2</sup>C addresses for KXG03-1034.

| Description         | Address Pad | 7-bit Address | Address | <7> | <6> | <5> | <4> | <3> | Y   |     | X   |     |
|---------------------|-------------|---------------|---------|-----|-----|-----|-----|-----|-----|-----|-----|-----|
|                     |             |               |         |     |     |     |     |     | <2> | <1> | <0> | <0> |
| I <sup>2</sup> C Wr | GND         | 0x4E          | 0x9C    | 1   | 0   | 0   | 1   | 1   | 1   | 0   | 0   | 0   |
| I <sup>2</sup> C Rd | GND         | 0x4E          | 0x9D    | 1   | 0   | 0   | 1   | 1   | 1   | 0   | 1   | 1   |
| I <sup>2</sup> C Wr | IO_VDD      | 0x4F          | 0x9E    | 1   | 0   | 0   | 1   | 1   | 1   | 1   | 0   | 0   |
| I <sup>2</sup> C Rd | IO_VDD      | 0x4F          | 0x9F    | 1   | 0   | 0   | 1   | 1   | 1   | 1   | 1   | 1   |

**Table 8:** I<sup>2</sup>C Slave Addresses for KXG03-1034

It is mandatory that receiving devices acknowledge (ACK) each transaction. Therefore, the transmitter must release the SDA line during this ACK pulse. The receiver then pulls the data line low so that it remains stable low during the high period of the ACK clock pulse. A receiver that has been addressed, whether it is Master or Slave, is obliged to generate an ACK after each byte of data has been received. To conclude a transaction, the Master must transmit a stop condition (P) by transitioning the SDA line from low to high while SCL is high. The I<sup>2</sup>C bus is now free. Note that if the KXG03 is accessed through I<sup>2</sup>C protocol before the startup is finished a NACK signal is sent.



# Digital Tri-axis Gyroscope/ Tri-axis Accelerometer Specifications

**PART NUMBER**  
**KXG03-1034**  
**Rev. 2.0**  
**14-Feb-17**

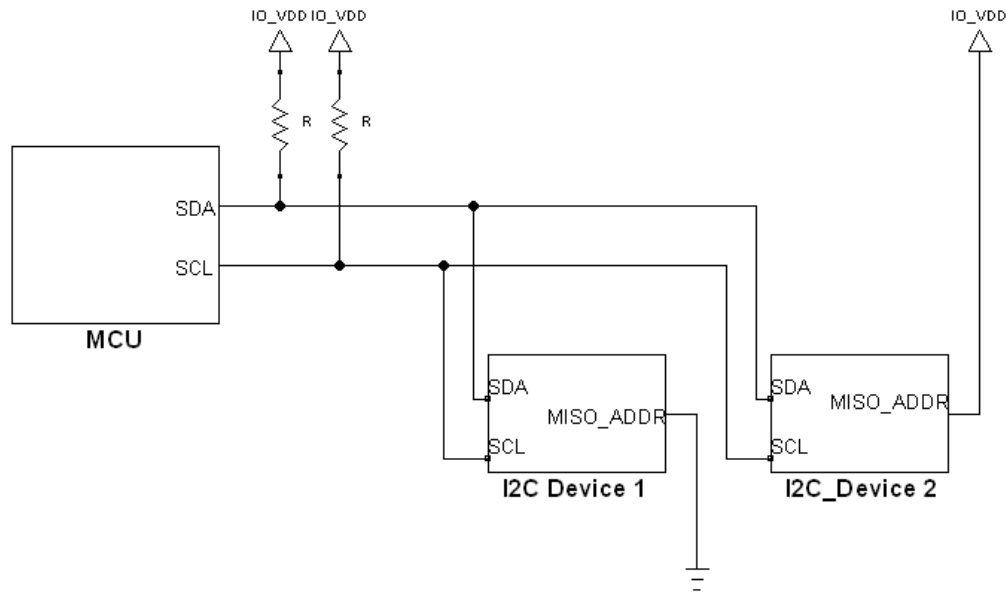

| I2C Device | Part Number | ADDR Pin | Slave Address | Bit Y (Bit 1 in 7-bit address) |
|------------|-------------|----------|---------------|--------------------------------|
| 1          | KXG03-1034  | GND      | 0x4E          | Factory Set to 1               |
| 2          | KXG03-1034  | IO_VDD   | 0x4F          | Factory Set to 1               |

**Figure 3: Multiple KXG03 Sensors on a Shared I<sup>2</sup>C Bus**

## Writing to 8-bit Register

Upon power up, the Master must write to the KXG03's control registers to set its operational mode. Therefore, when writing to a control register on the I<sup>2</sup>C bus, as shown Sequence 1 on the following page, the following protocol must be observed: After a start condition, SAD+W transmission, and the KXG03 ACK has been returned, an 8-bit Register Address (RA) command is transmitted by the Master. This command is telling the KXG03 to which 8-bit register the Master will be writing the data. Since this is I<sup>2</sup>C mode, the MSB of the RA command should always be zero (0). The KXG03 acknowledges the RA and the Master transmits the data to be stored in the 8-bit register. The KXG03 acknowledges that it has received the data and the Master transmits a stop condition (P) to end the data transfer. The data sent to the KXG03 is now stored in the appropriate register. The KXG03 automatically increments the received RA commands and, therefore, multiple bytes of data can be written to sequential registers after each Slave ACK as shown in Sequence 2 on the following page.

Note\*\* If a STOP condition is sent on the least significant bit of write data or the following master acknowledge cycle, the last write operation is not guaranteed and it may alter the content of the affected registers.

|   |  |  |
|---|--|--|
|  | <b>Digital Tri-axis Gyroscope/ Tri-axis Accelerometer Specifications</b> | <b>PART NUMBER</b><br><b>KXG03-1034</b><br><b>Rev. 2.0</b><br><b>14-Feb-17</b> |
|---|--|--|

### Reading from 8-bit Register

When reading data from a KXG03 8-bit register on the I<sup>2</sup>C bus, as shown in Sequence 3 on the next page, the following protocol must be observed: The Master first transmits a start condition (S) and the appropriate Slave Address (SAD) with the LSB set at '0' to write. The KXG03 acknowledges and the Master transmits the 8-bit RA of the register it wants to read. The KXG03 again acknowledges, and the Master transmits a repeated start condition (Sr). After the repeated start condition, the Master addresses the KXG03 with a '1' in the LSB (SAD+R) to read from the previously selected register. The Slave then acknowledges and transmits the data from the requested register. The Master does not acknowledge (NACK) it received the transmitted data, but transmits a stop condition to end the data transfer. Note that the KXG03 automatically increments through its sequential registers, allowing data to be read from multiple registers following a single SAD+R command as shown below in Sequence 4 below. Reading data from a buffer read register is a special case because if register address (RA) is set to buffer read register (BUF\_READ) in Sequence 4, the register auto-increment feature is automatically disabled. Instead, the Read Pointer will increment to the next data in the buffer, thus allowing reading multiple bytes of data from the buffer using a single SAD+R command. Note, accelerometer's and/or gyroscope's output data should be read in a single transaction using the auto-increment feature to prevent output data from being updated prior to intended completion of the read transaction.

**\*\*Note\*\*** KXG03's output data should be read in a single transaction using the auto-increment feature to prevent output data from being updated prior to intended completion of the read transaction.



# Digital Tri-axis Gyroscope/ Tri-axis Accelerometer Specifications

PART NUMBER

KXG03-1034

Rev. 2.0

14-Feb-17

## Data Transfer Sequences

The following information clearly illustrates the variety of data transfers that can occur on the I<sup>2</sup>C bus and how the Master and Slave interact during these transfers. The table below defines the I<sup>2</sup>C terms used during the data transfers.

| Term | Definition                |
|------|---------------------------|
| S    | Start Condition           |
| Sr   | Repeated Start Condition  |
| SAD  | Slave Address             |
| W    | Write Bit                 |
| R    | Read Bit                  |
| ACK  | Acknowledge               |
| NACK | Not Acknowledge           |
| RA   | Register Address          |
| Data | Transmitted/Received Data |
| P    | Stop Condition            |

Table 9: I<sup>2</sup>C Terms

**Sequence 1.** The Master is writing one byte to the Slave.

|        |   |         |     |    |     |      |     |   |
|--------|---|---------|-----|----|-----|------|-----|---|
| Master | S | SAD + W |     | RA |     | DATA |     | P |
| Slave  |   |         | ACK |    | ACK |      | ACK |   |

**Sequence 2.** The Master is writing multiple bytes to the Slave.

|        |   |         |     |    |     |      |     |      |     |   |
|--------|---|---------|-----|----|-----|------|-----|------|-----|---|
| Master | S | SAD + W |     | RA |     | DATA |     | DATA |     | P |
| Slave  |   |         | ACK |    | ACK |      | ACK |      | ACK |   |

**Sequence 3.** The Master is receiving one byte of data from the Slave.

|        |   |         |     |    |     |    |         |     |      |      |   |
|--------|---|---------|-----|----|-----|----|---------|-----|------|------|---|
| Master | S | SAD + W |     | RA |     | Sr | SAD + R |     |      | NACK | P |
| Slave  |   |         | ACK |    | ACK |    |         | ACK | DATA |      |   |

**Sequence 4.** The Master is receiving multiple bytes of data from the Slave.

|        |   |         |     |    |     |    |         |     |      |     |      |      |   |
|--------|---|---------|-----|----|-----|----|---------|-----|------|-----|------|------|---|
| Master | S | SAD + W |     | RA |     | Sr | SAD + R |     |      | ACK |      | NACK | P |
| Slave  |   |         | ACK |    | ACK |    |         | ACK | DATA |     | DATA |      |   |

|   |  |  |                    |  |
|---|--|--|--------------------|--|
|  | <b>Digital Tri-axis Gyroscope/ Tri-axis Accelerometer Specifications</b> |  | <b>PART NUMBER</b> |  |
|   |  |  | <b>KXG03-1034</b>  |  |
|   |  |  | <b>Rev. 2.0</b>    |  |
|   |  |  | <b>14-Feb-17</b>   |  |

**HS-mode**

To enter the 3.4MHz high speed mode of communication, the device must receive the following sequence of conditions from the master: a Start condition followed by a Master code (00001XXX) and a Master Non-acknowledge. Once recognized, the device switches to HS-mode communication. Read/write data transfers then proceed as described in the sequences above. Devices return to the FS-mode after a STOP occurrence on the bus.

**Sequence 5:** HS-mode data transfer of the Master writing multiple bytes to the Slave.

| Speed  | FS-mode |        |      | HS-mode |         |     |    |     |      |     |   | FS-mode |
|--------|---------|--------|------|---------|---------|-----|----|-----|------|-----|---|---------|
| Master | S       | M-code | NACK | Sr      | SAD + W |     | RA |     | DATA |     | P |         |
| Slave  |         |        |      |         |         | ACK |    | ACK |      | ACK |   |         |

n bytes + ack.

**Sequence 6:** HS-mode data transfer of the Master receiving multiple bytes of data from the Slave.

| Speed  | FS-mode |        |      | HS-mode |         |     |    |     |
|--------|---------|--------|------|---------|---------|-----|----|-----|
| Master | S       | M-code | NACK | Sr      | SAD + W |     | RA |     |
| Slave  |         |        |      |         |         | ACK |    | ACK |

| Speed  | HS-mode |         |     |      |     |      |      |   | FS-mode |
|--------|---------|---------|-----|------|-----|------|------|---|---------|
| Master | Sr      | SAD + R |     |      |     |      | NACK | P |         |
| Slave  |         |         | ACK | DATA | ACK | DATA |      |   |         |

(n-1) bytes + ack.



# Digital Tri-axis Gyroscope/ Tri-axis Accelerometer Specifications

PART NUMBER

KXG03-1034

Rev. 2.0

14-Feb-17

## I<sup>2</sup>C Timing Diagram

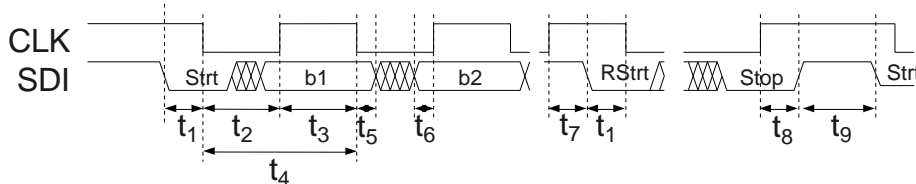

## I<sup>2</sup>C Timing Specifications

| Number         | Description  | Standard and Fast Mode |     | High Speed Mode |     | Units |
|----------------|--|------------------------|-----|-----------------|-----|-------|
|                |  | MIN                    | MAX | MIN             | MAX |       |
| t <sub>1</sub> | Hold time START condition                          | 600                    |     | 160             |     | ns    |
| t <sub>2</sub> | SCL low  | 1300                   |     | 320             |     | ns    |
| t <sub>3</sub> | SCL high   | 600                    |     | 120             |     | ns    |
| t <sub>4</sub> | SCL Period   | 25000                  |     | 588             |     | ns    |
| t <sub>5</sub> | SDI to SCL rise setup time                         | 100                    |     | 10              |     | ns    |
| t <sub>6</sub> | SCL fall to SDI hold time                          | 0                      | 900 | 0               | 150 | ns    |
| t <sub>7</sub> | Setup time for repeated START condition            | 600                    |     | 160             |     | ns    |
| t <sub>8</sub> | Setup time SCL rise to SDI rise for STOP condition | 600                    |     | 600             |     | ns    |
| t <sub>9</sub> | Bus free time between STOP and START conditions    | 1300                   |     | 1300            |     | ns    |
|                | SCL rise transition time (30-70%)                  |                        | 300 |                 | 160 | ns    |
|                | SCL fall transition time (30-70%)                  |                        | 300 |                 | 80  | ns    |
|                | SDI rise transition time (30-70%)                  |                        | 300 |                 | 80  | ns    |
|                | SDI fall transition time (30-70%)                  |                        | 300 |                 | 160 | ns    |

**Table 10:** I<sup>2</sup>C Timing Specifications (Standard, Fast and High Speed Mode)



|   |  |  |
|---|--|--|
|  | <b>Digital Tri-axis Gyroscope/ Tri-axis Accelerometer Specifications</b> | <b>PART NUMBER</b><br><b>KXG03-1034</b><br><b>Rev. 2.0</b><br><b>14-Feb-17</b> |
|---|--|--|

### Auxiliary I<sup>2</sup>C Operation

The KXG03 has an auxiliary I<sup>2</sup>C bus for communicating to external I<sup>2</sup>C-supported sensors. This bus has an I<sup>2</sup>C Host Mode where the KXG03 acts as a host to external sensors, and a Bypass Mode where the KXG03 directly connects the primary and auxiliary I<sup>2</sup>C buses together. This allows the system processor to directly communicate with the external sensors. Maximum data rate for this bus is 400KHz Fast Mode. With the auxiliary I<sup>2</sup>C enabled the AUX\_CL pin operates as an output-only pin. The auxiliary I<sup>2</sup>C hence does not support clock stretching and KXG03 should not be mated with external devices using clock stretching

### Auxiliary I<sup>2</sup>C Host Mode

This mode allows the KXG03 to directly access the data registers of any external sensors connected to the auxiliary I<sup>2</sup>C bus. In this mode, the KXG03 directly obtains data from the auxiliary sensors and packages them with its own sensor data inside the internal FIFO buffer.

In Host Mode the KXG03 is easily configured to read up to six successive registers from up to two different auxiliary devices. The user simply configures KXG03 control registers with up to two different I<sup>2</sup>C SAD's, starting register addresses and the number of bytes to be read back via auto-increment.

### Auxiliary I<sup>2</sup>C Bypass Mode

This mode allows an external processor to act as host and directly communicate to the auxiliary devices. This allows the host to initialize the auxiliary sensors for operation, or to access them directly while the KXG03 is disabled. The AUX\_CL and AUX\_DA pins can be operated in bypass mode shorted to SCLK\_SCL and the MOSI\_SDA pins, respectively. When operated in bypass mode the connection to the main I<sup>2</sup>C pins is broken while nCS is low (i.e. while the main interface is operating in SPI mode).

### Internal Pull-up Resistor

The auxiliary I<sup>2</sup>C interface can be operated with external or internal pull up devices. Internal pull up devices are automatically disabled in bypass mode to prevent pulling up the main I<sup>2</sup>C /SPI interface. The KXG03 AUX\_CL pin is driven by as a rail-to-rail (push-pull) CMOS output. The AUX\_CL pin hence does not require external (or internal) pull ups.

|   |  |                    |
|---|--|--------------------|
|  | <b>Digital Tri-axis Gyroscope/ Tri-axis Accelerometer Specifications</b> | <b>PART NUMBER</b> |
|   |  | <b>KXG03-1034</b>  |
|   |  | <b>Rev. 2.0</b>    |
|   |  | <b>14-Feb-17</b>   |

## SPI Communications

Special Note: The KXG03 has an I2C-disable bit I2C\_DIS in CTL\_REG\_1 that defaults to 0 (I2C enabled) on power up or when exiting reset. The state of this bit can only be changed via SPI communications. For applications using SPI on a shared bus (multiple slave devices on a single nCS line) I2C\_DIS should be set 1. Applications using a SPI interface on a dedicated bus (nCS connects only to KXG03 and not to any other slave devices) can function with I2C\_DIS set to 0 or 1. For applications using I2C interface I2C\_DIS should be set 0.

### 4-Wire SPI Interface

The KXG03 also utilizes an integrated 4-Wire Serial Peripheral Interface (SPI) for digital communication. The SPI interface is primarily used for synchronous serial communication between one Master device and one or more Slave devices. The Master, typically a micro controller, provides the SPI clock signal (SCLK) and determines the state of Chip Select (nCS). The KXG03 always operates as a Slave device during standard Master-Slave SPI operation.

4-wire SPI is a synchronous serial interface that uses two control and two data lines. With respect to the Master, the Serial Clock output (SCLK), the Data Output (SDI or MOSI) and the Data Input (SDO or MISO) are shared among the Slave devices. The Master generates an independent Chip Select (nCS) for each Slave device that goes low at the start of transmission and goes back high at the end. The Slave Data Output (SDO) line, remains in a high-impedance (hi-z) state when the device is not selected, so it does not interfere with any active devices. This allows multiple Slave devices to share a master SPI port as shown in the figure below.

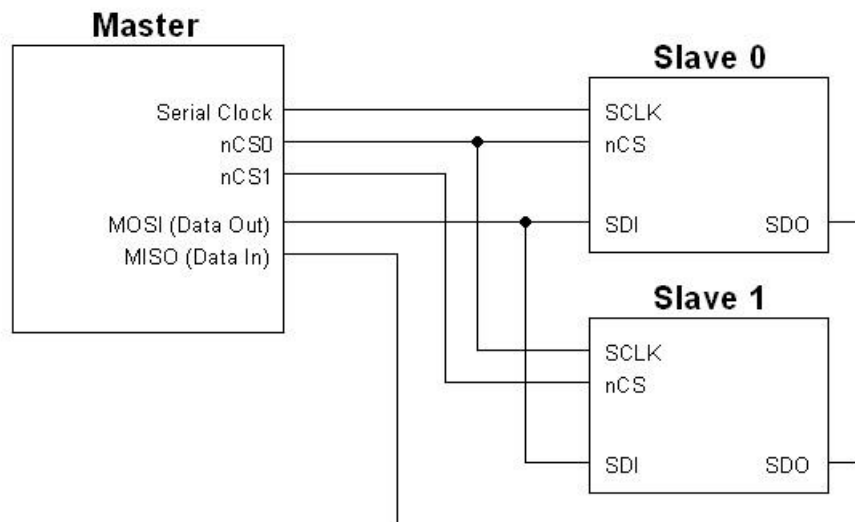

**Figure 4: 4-wire SPI Connections**



# Digital Tri-axis Gyroscope/ Tri-axis Accelerometer Specifications

**PART NUMBER**  
**KXG03-1034**  
 Rev. 2.0  
 14-Feb-17

## 4-Wire SPI Timing Diagram

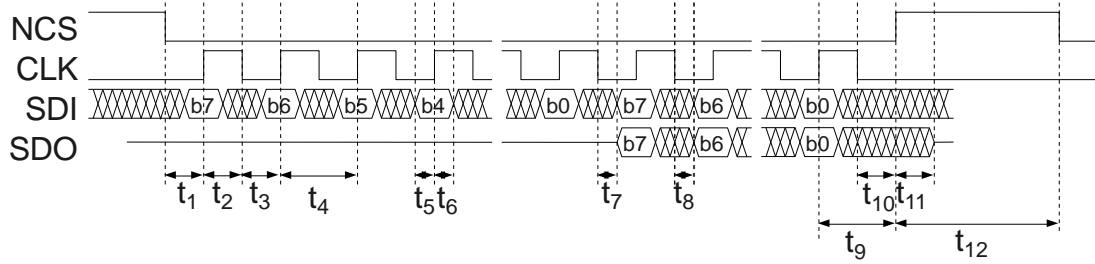

| Number | Description   | MIN | MAX | Units |
|--------|---|-----|-----|-------|
| t1     | NCS fall to SCL rise  | 40  |     | ns    |
| t2     | SCL pulse width high  | 40  |     | ns    |
| t3     | SCL pulse width low   | 40  |     | ns    |
| t4     | SCL period  | 98  |     | ns    |
| t5     | SDI to SCL rise setup time  | 10  |     | ns    |
| t6     | SCL rise to SDI hold time   | 10  |     | ns    |
| t7     | SCL rise to SDO enabled from tri-state  | 0   |     | ns    |
| t8     | SCL rise to SDO (min. = data invalid, max. = data valid)                      | 0   | 35  | ns    |
| t9     | SCL fall to NCS rise (Must be met only if SDI is not stable during this time) | 40  |     | ns    |
| t10    | NCS rise to SDO tri-state   |     | 40  | ns    |
| t11    | NCS high  | 100 |     | ns    |
| t12    | NCS rise to SCL rise  | 40  |     | ns    |

**Table 11: 4-Wire SPI Timing**



# Digital Tri-axis Gyroscope/ Tri-axis Accelerometer Specifications

**PART NUMBER**  
KXG03-1034  
Rev. 2.0  
14-Feb-17

## 4-Wire Read and Write Registers

The registers embedded in the KXG03 have 8-bit addresses. Upon power up, the Master must write to the sensor's control registers to set its operational mode. On the falling edge of nCS, a 2-byte command is written to the appropriate control register. The first byte initiates the write to the appropriate register, and is followed by the user-defined, data byte. The MSB (Most Significant Bit) of the register address byte will indicate "0" when writing to the register and "1" when reading from the register. This operation occurs over 16 clock cycles. All commands are sent MSB first. The host must return nCS high for at least one clock cycle before the next data request. However, when data is being read from a buffer read register (BUF\_READ), the nCS signal can remain low until the buffer is read. The Figure 5 shows the timing diagram for carrying out an 8-bit register write operation.

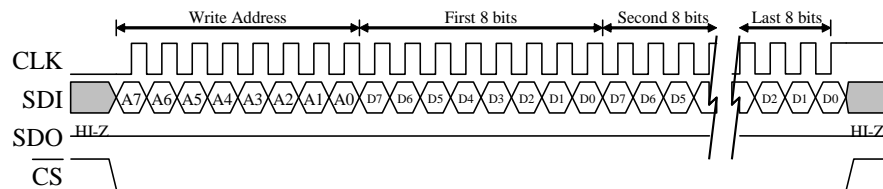

**Figure 5:** Timing Diagram for 8-Bit Register Write Operation

In order to read an 8-bit register, an 8-bit register address must be written to the sensor to initiate the read. The MSB of this register address byte will indicate "0" when writing to the register and "1" when reading from the register. Upon receiving the address, the sensor returns the 8-bit data stored in the addressed register. This operation also occurs over 16 clock cycles. All returned data is sent MSB first, and the host must return nCS high for at least one clock cycle before the next data request. The Figure 6 shows the timing diagram for an 8-bit register read operation.

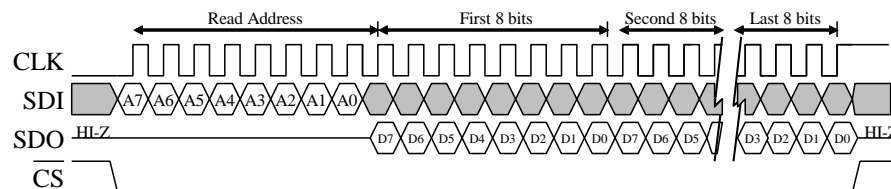

**Figure 6:** Timing Diagram for 8-Bit Register Read Operation

|   |  |                    |
|---|--|--------------------|
|  | <b>Digital Tri-axis Gyroscope/ Tri-axis Accelerometer Specifications</b> | <b>PART NUMBER</b> |
|   |  | KXG03-1034         |
|   |  | Rev. 2.0           |
|   |  | 14-Feb-17          |

## Power Modes

The KXG03 has three power modes: Off, Stand-by, and Active. The part exists in one of these three modes at any given time. Off and Stand-by modes have very low current consumptions.

| Power Mode   | Bus State | IO_VDD | VDD | Function  | Outputs                                   |
|--------------|-----------|--------|-----|---|---|
| Off          | -         | OFF    | OFF | No sensor activity                              | Not available                             |
| Off          | -         | ON     | OFF | No sensor activity                              | Not available                             |
| Off          | -         | OFF    | ON  | No sensor activity                              | Not available                             |
| Stand-by     | Active    | ON     | ON  | Waiting activation command                      | Not available                             |
| Active - WUF | Active    | ON     | ON  | Accelerometer active looking for motion Wake-up | Accelerometer registers, buffer, and DRDY |
| Active       | Active    | ON     | ON  | All functionalities available                   | All sensors available                     |

### Off mode

One or both of the power supplies (VDD or IO\_VDD) are not powered. The sensor is completely inactive and not reporting or communicating. Bus communication actions of other devices are not disturbed if they are using the same bus interface as this component.

### Initial Startup

The preferred startup sequence is to turn on IO\_VDD before VDD, but if VDD is turned on first, the component will not affect the bus communications (no latch-up or other problems during engine system level wake-up).

Power-On Reset (POR) is performed every time when:

1. IO\_VDD supply is valid
2. VDD power supply is going to valid level

### OR

1. IO\_VDD power supply is going to valid level
2. VDD supply is valid

When POR occurs, the registers are loaded from OTP and the part is put into Stand-by mode.

|   |  |  |
|---|--|--|
|  | <b>Digital Tri-axis Gyroscope/ Tri-axis Accelerometer Specifications</b> | <b>PART NUMBER</b><br><b>KXG03-1034</b><br><b>Rev. 2.0</b><br><b>14-Feb-17</b> |
|---|--|--|

**Stand-by mode**

The primary function of the stand-by mode is to ensure fast wake-up to active mode and to minimize current consumption. This mode is set as default when both power supplies are applied and the POR function occurs. A Soft Reset command also performs the POR function and puts the part into Stand-by mode.

Stand-by mode is a low power waiting state for fast turn on time. Bus communication actions of other components are not disturbed if they are using the same bus. There is only one possible way to change to active mode – a register command from the external application processor via the I<sup>2</sup>C bus.

**Active WUF mode**

While in Active WUF mode, the accelerometer is periodically taking a measurement to detect if there is any motion. Data in the accelerometer registers is being updated and can be sent to the buffer, and data ready interrupt can be reported.

**Active Wake and Sleep mode**

Stand-by-mode can be changed to Active mode by writing to register STBY\_REG or by use of the WUF.

Active mode engages the full functionality of accelerometer and/or gyroscope measurements in two possible configurations, one is named Wake the other Sleep. The user can select separate configurations for each mode such as ODR, BW, FS-range and even Standby bits for each mode. For example, the user could enable all sensors in Wake state and only the Aux sensor in Sleep state. Or the user could enable the accelerometer in low power mode during Wake state and both the gyroscope and accelerometer in sleep state

The WUF and BTS functions can be used to automatically switch between the two modes based on measured accelerometer activity. The user can select which functions and sensors are enabled for each mode.

|   |  |   |
|---|--|---|
|  | <b>Digital Tri-axis Gyroscope/ Tri-axis Accelerometer Specifications</b> | <b>PART NUMBER</b><br>KXG03-1034<br>Rev. 2.0<br>14-Feb-17 |
|---|--|---|

## Embedded Wake-up and Back-to-Sleep Function

The KXG03 contains an interrupt engine that can be configured by the user to report when qualified changes detected by the acceleration occur, using the accelerometer. The user has the option to enable or disable specific accelerometer axes and specific directions, as well as to specify the delay time. An example use case for the engine would be to detect motion on any axis to signal an event and wake up or put back to sleep the KXG03 or other devices. For Wake-up (WUF), this can be achieved by configuring the engine to detect when the acceleration on any axis is *greater* than the user-defined threshold for a user-defined amount of time. For Back-To-Sleep (BTS), this can be achieved by configuring the engine to detect when the acceleration on any axis is *less* than the user-defined threshold for a user-defined amount of time. The KXG03 will change modes when the WUF or BTS functions trigger. The user can manually force the KXG03 into Wake or Sleep modes using the MAN\_WAKE and MAN\_SLEEP bits. The equations below show how to calculate the engine threshold and delay time register values for the desired result.

$$\text{Wake-up Threshold (counts)} = \text{Desired Threshold (g)} \times 16 \text{ (counts/g)}$$

**Equation 1:** Wake-up Threshold

$$\text{Back-To-Sleep Threshold (counts)} = \text{Desired Threshold (g)} \times 16 \text{ (counts/g)}$$

**Equation 2:** Back-To-Sleep Threshold

$$\text{Back-To-Sleep Threshold (counts)} = \text{Desired Delay Time (sec)} \times \text{OWUF (Hz)}$$

**Equation 3:** Wake-up Delay Time

$$\text{Back-To-Sleep Delay Time (counts)} = \text{Desired Delay Time (sec)} \times \text{OSA (Hz)}$$

**Equation 4:** Back-To-Sleep Delay Time



# Digital Tri-axis Gyroscope/ Tri-axis Accelerometer Specifications

**PART NUMBER**

**KXG03-1034**

**Rev. 2.0**

**14-Feb-17**

## Embedded Registers

The KXG03 has embedded 8-bit registers that are accessible by the user. This section contains the addresses for all embedded registers and also describes bit functions of each register. The table below provides a listing of the accessible 8-bit registers and their addresses.

| Register Name | R/W | Address | Register Name   | R/W | Address   | Register Name   | R/W | Address   |
|---------------|-----|---------|-----------------|-----|-----------|-----------------|-----|-----------|
| TEMP_OUT_L    | R   | 0x00    | BUF_PAST_L      | R   | 0x20      | WAKE_SLEEP_CTL2 | R/W | 0x4C      |
| TEMP_OUT_H    | R   | 0x01    | BUF_PAST_H      | R   | 0x21      | WUF_TH          | R/W | 0x4D      |
| GYRO_XOUT_L   | R   | 0x02    | AUX_STATUS      | R   | 0x22      | WUF_COUNTER     | R/W | 0x4E      |
| GYRO_XOUT_H   | R   | 0x03    | RESERVED        | R   | 0x23-0x2F | BTS_TH          | R/W | 0x4F      |
| GYRO_YOUT_L   | R   | 0x04    | WHO_AM_I        | R   | 0x30      | BTS_COUNTER     | R/W | 0x50      |
| GYRO_YOUT_H   | R   | 0x05    | SN1_MIR         | R   | 0x31      | AUX_I2C_CTL_REG | R/W | 0x51      |
| GYRO_ZOUT_L   | R   | 0x06    | SN2_MIR         | R   | 0x32      | AUX_I2C_SAD1    | R/W | 0x52      |
| GYRO_ZOUT_H   | R   | 0x07    | SN3_MIR         | R   | 0x33      | AUX_I2C_REG1    | R/W | 0x53      |
| ACC_XOUT_L    | R   | 0x08    | SN4_MIR         | R   | 0x34      | AUX_I2C_CTL1    | R/W | 0x54      |
| ACC_XOUT_H    | R   | 0x09    | RESERVED        | R   | 0x35      | AUX_I2C_BIT1    | R/W | 0x55      |
| ACC_YOUT_L    | R   | 0x0A    | STATUS1         | R/W | 0x36      | AUX_I2C_ODR1_W  | R/W | 0x56      |
| ACC_YOUT_H    | R   | 0x0B    | INT1_SRC1       | R   | 0x37      | AUX_I2C_ODR1_S  | R/W | 0x57      |
| ACC_ZOUT_L    | R   | 0x0C    | INT1_SRC2       | R   | 0x38      | AUX_I2C_SAD2    | R/W | 0x58      |
| ACC_ZOUT_H    | R   | 0x0D    | INT1_L          | R   | 0x39      | AUX_I2C_REG2    | R/W | 0x59      |
| AUX1_OUT1     | R   | 0x0E    | STATUS2         | R/W | 0x3A      | AUX_I2C_CTL2    | R/W | 0x5A      |
| AUX1_OUT2     | R   | 0x0F    | INT2_SRC1       | R   | 0x3B      | AUX_I2C_BIT2    | R/W | 0x5B      |
| AUX1_OUT3     | R   | 0x10    | INT2_SRC2       | R   | 0x3C      | AUX_I2C_ODR2_W  | R/W | 0x5C      |
| AUX1_OUT4     | R   | 0x11    | INT2_L          | R   | 0x3D      | AUX_I2C_ODR2_S  | R/W | 0x5D      |
| AUX1_OUT5     | R   | 0x12    | ACCEL_ODR_WAKE  | R/W | 0x3E      | RESERVED        | R/W | 0x5E-0x74 |
| AUX1_OUT6     | R   | 0x13    | ACCEL_ODR_SLEEP | R/W | 0x3F      | BUF_WMITH_L     | R/W | 0x75      |
| AUX2_OUT1     | R   | 0x14    | ACCEL_CTL       | R/W | 0x40      | BUF_WMITH_H     | R/W | 0x76      |
| AUX2_OUT2     | R   | 0x15    | GYRO_ODR_WAKE   | R/W | 0x41      | BUF_TRIGTH_L    | R/W | 0x77      |
| AUX2_OUT3     | R   | 0x16    | GYRO_ODR_SLEEP  | R/W | 0x42      | BUF_TRIGTH_H    | R/W | 0x78      |
| AUX2_OUT4     | R   | 0x17    | STDBY           | R/W | 0x43      | BUF_CTL2        | R/W | 0x79      |
| AUX2_OUT5     | R   | 0x18    | CTL_REG_1       | R/W | 0x44      | BUF_CTL3        | R/W | 0x7A      |
| AUX2_OUT6     | R   | 0x19    | INT_PIN_CTL     | R/W | 0x45      | BUF_CTL4        | R/W | 0x7B      |
| WAKE_CNT_L    | R   | 0x1A    | INT_PIN1_SEL    | R/W | 0x46      | BUF_EN          | R/W | 0x7C      |
| WAKE_CNT_H    | R   | 0x1B    | INT_PIN2_SEL    | R/W | 0x47      | BUF_STATUS      | R   | 0x7D      |
| SLEEP_CNT_L   | R   | 0x1C    | INT_MASK1       | R/W | 0x48      | BUF_CLEAR       | R/W | 0x7E      |
| SLEEP_CNT_H   | R   | 0x1D    | INT_MASK2       | R/W | 0x49      | BUF_READ        | R   | 0x7F      |
| BUF_SMPLEV_L  | R   | 0x1E    | FSYNC_CTL       | R/W | 0x4A      |                 |     |           |
| BUF_SMPLEV_H  | R   | 0x1F    | WAKE_SLEEP_CTL1 | R/W | 0x4B      |                 |     |           |

**Table 12: I2C Register Map**





## Digital Tri-axis Gyroscope/ Tri-axis Accelerometer Specifications

**PART NUMBER**

**KXG03-1034**

**Rev. 2.0**

**14-Feb-17**

### Gyroscope Outputs

These registers contain 16-bits of valid angular rate data for each axis. The data is protected from overwrite during each read, and can be converted from digital counts to angular rate (deg/sec) per the table below.

| 16-bit Data (2's complement) | Equivalent Counts in decimal | Range = $\pm 2048$ deg/sec | Range = $\pm 1024$ deg/sec | Range = $\pm 512$ deg/sec | Range = $\pm 256$ deg/sec |
|------------------------------|------------------------------|----------------------------|----------------------------|---------------------------|---------------------------|
| 0111 1111 1111 1111          | 32767                        | +2047.9375                 | +1023.9688                 | +511.9844                 | +255.9922                 |
| 0111 1111 1111 1110          | 32766                        | +2047.8750                 | +1023.9376                 | +511.9688                 | +255.9844                 |
| ...                          | ...                          | ...                        | ...                        | ...                       | ...                       |
| 0000 0000 0000 0001          | 1                            | +0.0625                    | +0.0312                    | +0.0156                   | +0.0078                   |
| 0000 0000 0000 0000          | 0                            | 0 deg/sec                  | 0 deg/sec                  | 0 deg/sec                 | 0 deg/sec                 |
| 1111 1111 1111 1111          | -1                           | -0.0625                    | -0.0312                    | -0.0156                   | -0.0078                   |
| ...                          | ...                          | ...                        | ...                        | ...                       | ...                       |
| 1000 0000 0000 0001          | -32767                       | -2047.9375                 | -1023.9688                 | -511.9844                 | -255.9922                 |
| 1000 0000 0000 0000          | -32768                       | -2048.0000                 | -1024.0000                 | -512.0000                 | -256.0000                 |

**Table 13:** Angular Rate (deg/sec) Calculation

### Accelerometer Outputs

These registers contain 16-bits of valid angular rate data for each axis. The data is protected from overwrite during each read, and can be converted from digital counts to acceleration (g) per the table below.

| 16-bit Data (2's complement) | Equivalent Counts in decimal | Range = $\pm 2g$ | Range = $\pm 4g$ | Range = $\pm 8g$ | Range = $\pm 16g$ |
|------------------------------|------------------------------|------------------|------------------|------------------|-------------------|
| 0111 1111 1111 1111          | 32767                        | +2.0000g         | +3.9999g         | +7.9998g         | +15.9996g         |
| 0111 1111 1111 1110          | 32766                        | +1.9999g         | +3.9998g         | +7.9995g         | +15.9992g         |
| ...                          | ...                          | ...              | ...              | ...              | ...               |
| 0000 0000 0000 0001          | 1                            | +0.00006g        | +0.0001g         | +0.0002g         | +0.0004g          |
| 0000 0000 0000 0000          | 0                            | 0.000g           | 0.0000g          | 0.0000g          | 0.0000g           |
| 1111 1111 1111 1111          | -1                           | -0.00006g        | -0.0001g         | -0.0002g         | -0.0004g          |
| ...                          | ...                          | ...              | ...              | ...              | ...               |
| 1000 0000 0000 0001          | -32767                       | -1.9999g         | -3.9999g         | -7.9998g         | -15.9996g         |
| 1000 0000 0000 0000          | -32768                       | -2.0000g         | -4.0000g         | -8.000g          | -15.000g          |

**Table 14:** Acceleration (g) Calculation



# Digital Tri-axis Gyroscope/ Tri-axis Accelerometer Specifications

**PART NUMBER**

**KXG03-1034**

**Rev. 2.0**

**14-Feb-17**

## Temperature Sensor Outputs

The temperature registers contain up to 16-bits of temperature data. Sensitivity can be considered as 128 counts/°C, or 7.8mC/LSB.

| 16-bit Register Data (2's complement) | Equivalent Counts in decimal | Temperature (°C) |
|---------------------------------------|------------------------------|------------------|
| 0010 1010 1000 0000                   | 10880                        | +85.000 °C       |
| ...                                   | ...                          | ...              |
| 0000 0000 1000 0000                   | 128                          | +1.0000 °C       |
| ...                                   | ...                          | ...              |
| 0000 0000 0000 0001                   | 1                            | +0.0078 °C       |
| 0000 0000 0000 0000                   | 0                            | 0.0000 °C        |
| 1111 1111 1111 1111                   | -1                           | -0.0078 °C       |
| ...                                   | ...                          | ...              |
| 1111 1111 1000 0000                   | -128                         | -1.0000 °C       |
| ...                                   | ...                          | ...              |
| 1110 1100 0000 0000                   | -5120                        | -40.000 °C       |

**Table 15:** Temperature (C) Calculation



# Digital Tri-axis Gyroscope/ Tri-axis Accelerometer Specifications

**PART NUMBER**

**KXG03-1034**

**Rev. 2.0**

**14-Feb-17**

## Register Descriptions

### TEMP\_OUT

Temperature Output least and most significant bytes TEMP\_OUT\_L and TEMP\_OUT\_H

|                    |        |        |        |        |        |       |       |
|--------------------|--------|--------|--------|--------|--------|-------|-------|
| R                  | R      | R      | R      | R      | R      | R     | R     |
| TEMP7              | TEMP6  | TEMP5  | TEMP4  | TEMP3  | TEMP2  | TEMP1 | TEMP0 |
| TEMP15             | TEMP14 | TEMP13 | TEMP12 | TEMP11 | TEMP10 | TEMP9 | TEMP8 |
| Bit7               | Bit6   | Bit5   | Bit4   | Bit3   | Bit2   | Bit1  | Bit0  |
| Address: 0x00,0x01 |        |        |        |        |        |       |       |

### GYRO\_XOUT

X-axis gyroscope output least and most significant bytes GYRO\_XOUT\_L and GYRO\_XOUT\_H

|                    |          |          |          |          |          |         |         |
|--------------------|----------|----------|----------|----------|----------|---------|---------|
| R                  | R        | R        | R        | R        | R        | R       | R       |
| GYRO_X7            | GYRO_X6  | GYRO_X5  | GYRO_X4  | GYRO_X3  | GYRO_X2  | GYRO_X1 | GYRO_X0 |
| GYRO_X15           | GYRO_X14 | GYRO_X13 | GYRO_X12 | GYRO_X11 | GYRO_X10 | GYRO_X9 | GYRO_X8 |
| Bit7               | Bit6     | Bit5     | Bit4     | Bit3     | Bit2     | Bit1    | Bit0    |
| Address: 0x02,0x03 |          |          |          |          |          |         |         |

### GYRO\_YOUT

Y-axis gyroscope output least and most significant bytes GYRO\_YOUT\_L and GYRO\_YOUT\_H

|                    |          |          |          |          |          |         |         |
|--------------------|----------|----------|----------|----------|----------|---------|---------|
| R                  | R        | R        | R        | R        | R        | R       | R       |
| GYRO_Y7            | GYRO_Y6  | GYRO_Y5  | GYRO_Y4  | GYRO_Y3  | GYRO_Y2  | GYRO_Y1 | GYRO_Y0 |
| GYRO_Y15           | GYRO_Y14 | GYRO_Y13 | GYRO_Y12 | GYRO_Y11 | GYRO_Y10 | GYRO_Y9 | GYRO_Y8 |
| Bit7               | Bit6     | Bit5     | Bit4     | Bit3     | Bit2     | Bit1    | Bit0    |
| Address: 0x04,0x05 |          |          |          |          |          |         |         |

### GYRO\_ZOUT

Z-axis gyroscope output least and most significant bytes GYRO\_ZOUT\_L and GYRO\_ZOUT\_H

|                    |          |          |          |          |          |         |         |
|--------------------|----------|----------|----------|----------|----------|---------|---------|
| R                  | R        | R        | R        | R        | R        | R       | R       |
| GYRO_Z7            | GYRO_Z6  | GYRO_Z5  | GYRO_Z4  | GYRO_Z3  | GYRO_Z2  | GYRO_Z1 | GYRO_Z0 |
| GYRO_Z15           | GYRO_Z14 | GYRO_Z13 | GYRO_Z12 | GYRO_Z11 | GYRO_Z10 | GYRO_Z9 | GYRO_Z8 |
| Bit7               | Bit6     | Bit5     | Bit4     | Bit3     | Bit2     | Bit1    | Bit0    |
| Address: 0x06,0x07 |          |          |          |          |          |         |         |



# Digital Tri-axis Gyroscope/ Tri-axis Accelerometer Specifications

**PART NUMBER**

**KXG03-1034**

**Rev. 2.0**

**14-Feb-17**

## ACCEL\_XOUT

X-axis accelerometer output least and most significant byte ACCEL\_XOUT\_L and ACCEL\_XOUT\_H

|                    |           |           |           |           |           |          |          |
|--------------------|-----------|-----------|-----------|-----------|-----------|----------|----------|
| R                  | R         | R         | R         | R         | R         | R        | R        |
| ACCEL_X7           | ACCEL_X6  | ACCEL_X5  | ACCEL_X4  | ACCEL_X3  | ACCEL_X2  | ACCEL_X1 | ACCEL_X0 |
| ACCEL_X15          | ACCEL_X14 | ACCEL_X13 | ACCEL_X12 | ACCEL_X11 | ACCEL_X10 | ACCEL_X9 | ACCEL_X8 |
| Bit7               | Bit6      | Bit5      | Bit4      | Bit3      | Bit2      | Bit1     | Bit0     |
| Address: 0x08,0x09 |           |           |           |           |           |          |          |

## ACCEL\_YOUT

Y-axis accelerometer output least and most significant byte ACCEL\_YOUT\_L and ACCEL\_YOUT\_H

|                    |           |           |           |           |           |          |          |
|--------------------|-----------|-----------|-----------|-----------|-----------|----------|----------|
| R                  | R         | R         | R         | R         | R         | R        | R        |
| ACCEL_Y7           | ACCEL_Y6  | ACCEL_Y5  | ACCEL_Y4  | ACCEL_Y3  | ACCEL_Y2  | ACCEL_Y1 | ACCEL_Y0 |
| ACCEL_Y15          | ACCEL_Y14 | ACCEL_Y13 | ACCEL_Y12 | ACCEL_Y11 | ACCEL_Y10 | ACCEL_Y9 | ACCEL_Y8 |
| Bit7               | Bit6      | Bit5      | Bit4      | Bit3      | Bit2      | Bit1     | Bit0     |
| Address: 0x0A,0x0B |           |           |           |           |           |          |          |

## ACCEL\_ZOUT

Z-axis accelerometer output least and most significant byte ACCEL\_ZOUT\_L and ACCEL\_ZOUT\_H

|                    |           |           |           |           |           |          |          |
|--------------------|-----------|-----------|-----------|-----------|-----------|----------|----------|
| R                  | R         | R         | R         | R         | R         | R        | R        |
| ACCEL_Z7           | ACCEL_Z6  | ACCEL_Z5  | ACCEL_Z4  | ACCEL_Z3  | ACCEL_Z2  | ACCEL_Z1 | ACCEL_Z0 |
| ACCEL_Z15          | ACCEL_Z14 | ACCEL_Z13 | ACCEL_Z12 | ACCEL_Z11 | ACCEL_Z10 | ACCEL_Z9 | ACCEL_Z8 |
| Bit7               | Bit6      | Bit5      | Bit4      | Bit3      | Bit2      | Bit1     | Bit0     |
| Address: 0x0C,0x0D |           |           |           |           |           |          |          |

## AUX1\_OUT

Auxiliary Sensor #1 output data bytes AUX1\_OUT1 through AUX1\_OUT6

|                       |          |          |          |          |          |          |          |             |
|-----------------------|----------|----------|----------|----------|----------|----------|----------|-------------|
| R                     | R        | R        | R        | R        | R        | R        | R        | Reset Value |
| AUX1_1_7              | AUX1_1_6 | AUX1_1_5 | AUX1_1_4 | AUX1_1_3 | AUX1_1_2 | AUX1_1_1 | AUX1_1_0 | 0000        |
| AUX1_2_7              | AUX1_2_6 | AUX1_2_5 | AUX1_2_4 | AUX1_2_3 | AUX1_2_2 | AUX1_2_1 | AUX1_2_0 | 0000        |
| AUX1_3_7              | AUX1_3_6 | AUX1_3_5 | AUX1_3_4 | AUX1_3_3 | AUX1_3_2 | AUX1_3_1 | AUX1_3_0 | 0000        |
| AUX1_4_7              | AUX1_4_6 | AUX1_4_5 | AUX1_4_4 | AUX1_4_3 | AUX1_4_2 | AUX1_4_1 | AUX1_4_0 | 0000        |
| AUX1_5_7              | AUX1_5_6 | AUX1_5_5 | AUX1_5_4 | AUX1_5_3 | AUX1_5_2 | AUX1_5_1 | AUX1_5_0 | 0000        |
| AUX1_6_7              | AUX1_6_6 | AUX1_6_5 | AUX1_6_4 | AUX1_6_3 | AUX1_6_2 | AUX1_6_1 | AUX1_6_0 | 0000        |
| Bit7                  | Bit6     | Bit5     | Bit4     | Bit3     | Bit2     | Bit1     | Bit0     |             |
| Address: 0x0E to 0x13 |          |          |          |          |          |          |          |             |



# Digital Tri-axis Gyroscope/ Tri-axis Accelerometer Specifications

**PART NUMBER**

**KXG03-1034**

**Rev. 2.0**

**14-Feb-17**

## AUX2\_OUT

Auxiliary Sensor #2 output data bytes AUX2\_OUT1 through AUX2\_OUT6

| R                     | R        | R        | R        | R        | R        | R        | R        | Reset Value |
|-----------------------|----------|----------|----------|----------|----------|----------|----------|-------------|
| AUX2_1_7              | AUX2_1_6 | AUX2_1_5 | AUX2_1_4 | AUX2_1_3 | AUX2_1_2 | AUX2_1_1 | AUX2_1_0 | 0000        |
| AUX2_2_7              | AUX2_2_6 | AUX2_2_5 | AUX2_2_4 | AUX2_2_3 | AUX2_2_2 | AUX2_2_1 | AUX2_2_0 | 0000        |
| AUX2_3_7              | AUX2_3_6 | AUX2_3_5 | AUX2_3_4 | AUX2_3_3 | AUX2_3_2 | AUX2_3_1 | AUX2_3_0 | 0000        |
| AUX2_4_7              | AUX2_4_6 | AUX2_4_5 | AUX2_4_4 | AUX2_4_3 | AUX2_4_2 | AUX2_4_1 | AUX2_4_0 | 0000        |
| AUX2_5_7              | AUX2_5_6 | AUX2_5_5 | AUX2_5_4 | AUX2_5_3 | AUX2_5_2 | AUX2_5_1 | AUX2_5_0 | 0000        |
| AUX2_6_7              | AUX2_6_6 | AUX2_6_5 | AUX2_6_4 | AUX2_6_3 | AUX2_6_2 | AUX2_6_1 | AUX2_6_0 | 0000        |
| Bit7                  | Bit6     | Bit5     | Bit4     | Bit3     | Bit2     | Bit1     | Bit0     |             |
| Address: 0x14 to 0x19 |          |          |          |          |          |          |          |             |

## WAKE\_CNT

Number of ODR cycles spent in wake state as measured in accelerometer ODRa\_wake/ODRa\_sleep periods. Data byte WAKE\_CNT\_L and WAKE\_CNT\_H.

| R                  | R        | R        | R        | R        | R        | R       | R       | Reset Value |
|--------------------|----------|----------|----------|----------|----------|---------|---------|-------------|
| WAKE_C7            | WAKE_C6  | WAKE_C5  | WAKE_C4  | WAKE_C3  | WAKE_C2  | WAKE_C1 | WAKE_C0 | 0000        |
| WAKE_C15           | WAKE_C14 | WAKE_C13 | WAKE_C12 | WAKE_C11 | WAKE_C10 | WAKE_C9 | WAKE_C8 | 0000        |
| Bit7               | Bit6     | Bit5     | Bit4     | Bit3     | Bit2     | Bit1    | Bit0    |             |
| Address: 0x1A,0x1B |          |          |          |          |          |         |         |             |

## SLEEP\_CNT

Number of ODR cycles spent in sleep state as measured in accelerometer ODRa\_wake/ODRa\_sleep periods. Data byte SLEEP\_CNT\_L and SLEEP\_CNT\_H.

| R                  | R         | R         | R         | R         | R         | R        | R        | Reset Value |
|--------------------|-----------|-----------|-----------|-----------|-----------|----------|----------|-------------|
| SLEEP_C7           | SLEEP_C6  | SLEEP_C5  | SLEEP_C4  | SLEEP_C3  | SLEEP_C2  | SLEEP_C1 | SLEEP_C0 | 0000        |
| SLEEP_C15          | SLEEP_C14 | SLEEP_C13 | SLEEP_C12 | SLEEP_C11 | SLEEP_C10 | SLEEP_C9 | SLEEP_C8 | 0000        |
| Bit7               | Bit6      | Bit5      | Bit4      | Bit3      | Bit2      | Bit1     | Bit0     |             |
| Address: 0x1C,0x1D |           |           |           |           |           |          |          |             |

|   |  |                    |
|---|--|--------------------|
|  | <b>Digital Tri-axis Gyroscope/ Tri-axis Accelerometer Specifications</b> | <b>PART NUMBER</b> |
|   |  | KXG03-1034         |
|   |  | Rev. 2.0           |
|   |  | 14-Feb-17          |

**BUF\_SMPLEV**

Reports the number of data packets (ODR cycles) currently stored in the buffer. Reading the buffer contents, BUF\_SMPLEV or BUF\_PAST within 10 us from enabling or clearing the buffer is not permitted to avoid corrupted data. Data bytes BUF\_SMPLEV\_L and BUF\_SMPLEV\_H

|                    |          |          |          |          |          |          |          |             |
|--------------------|----------|----------|----------|----------|----------|----------|----------|-------------|
| R                  | R        | R        | R        | R        | R        | R        | R        | Reset Value |
| SMP_LEV1           | SMP_LEV0 | Reserved | Reserved | Reserved | Reserved | Reserved | Reserved | 0000        |
| SMP_LEV9           | SMP_LEV8 | SMP_LEV7 | SMP_LEV6 | SMP_LEV5 | SMP_LEV4 | SMP_LEV3 | SMP_LEV2 | 0000        |
| Bit7               | Bit6     | Bit5     | Bit4     | Bit3     | Bit2     | Bit1     | Bit0     |             |
| Address: 0x1E,0x1F |          |          |          |          |          |          |          |             |

**BUF\_PAST**

Reports the number of data packets lost since buffer has been filled. Reading the buffer contents, BUF\_SMPLEV or BUF\_PAST within 10 us from enabling or clearing the buffer is not permitted to avoid corrupted data. Data bytes BUF\_PAST\_L and BUF\_PAST\_H

|                    |           |           |           |           |           |           |           |             |
|--------------------|-----------|-----------|-----------|-----------|-----------|-----------|-----------|-------------|
| R                  | R         | R         | R         | R         | R         | R         | R         | Reset Value |
| SMP_PAST1          | SMP_PAST0 | Reserved  | Reserved  | Reserved  | Reserved  | Reserved  | Reserved  | 0000        |
| SMP_PAST9          | SMP_PAST8 | SMP_PAST7 | SMP_PAST6 | SMP_PAST5 | SMP_PAST4 | SMP_PAST3 | SMP_PAST2 | 0000        |
| Bit7               | Bit6      | Bit5      | Bit4      | Bit3      | Bit2      | Bit1      | Bit0      |             |
| Address: 0x20,0x21 |           |           |           |           |           |           |           |             |

**AUX\_STATUS**

Reports the status of Auxiliary Sensors AUX1 and AUX2.

|               |         |         |         |          |         |         |         |             |
|---------------|---------|---------|---------|----------|---------|---------|---------|-------------|
| R             | R       | R       | R       | R        | R       | R       | R       | Reset Value |
| AUX2FAIL      | AUX2ERR | AUX2ST1 | AUX2ST0 | AUX1FAIL | AUX1ERR | AUX1ST1 | AUX1ST0 | 00000000    |
| Bit7          | Bit6    | Bit5    | Bit4    | Bit3     | Bit2    | Bit1    | Bit0    |             |
| Address: 0x22 |         |         |         |          |         |         |         |             |

**AUX1ST[1:0]** - Detailed aux1 communication status.

2'b00: Aux1 sensor is disabled.

Aux1 has not been enabled or KXG03 has successfully sent disable cmd.

2'b01: Aux1 sensor is waiting to be enabled.

KXG03 is attempting to enable aux sensor via enable sequence.

2'b10: Aux1 sensor is waiting to be disabled.

KXG03 is attempting to disable aux sensor via disable sequence.

2'b11: Aux1 sensor is running.

KXG03 has successfully sent aux enable cmd.

**AUX1ERR** - Aux1 data read error flag.

|   |  |   |
|---|--|---|
|  | <b>Digital Tri-axis Gyroscope/ Tri-axis Accelerometer Specifications</b> | <b>PART NUMBER</b><br>KXG03-1034<br>Rev. 2.0<br>14-Feb-17 |
|---|--|---|

0: No error detected.

1: Missing ACK detected during aux1 polling. KXG03 will retry polling aux device at next scheduled ODR period.

Flag is cleared by writing (any value) into AUX\_STATUS register.

**AUX1FAIL** - Aux1 command sequence failure flag.

0: No failure detected.

1: Missing ACK detected after writing control register address to aux1 device during enable/disable command sequence. KXG03 will suspend aux1 communications until AUX1FAIL bit is cleared by user.

Flag is cleared by writing (any value) into AUX\_STATUS register.

**AUX2ST[1:0]** - Detailed aux2 communication status.

2'b00: Aux2 sensor is disabled.

Aux2 has not been enabled or KXG03 has successfully sent disable cmd.

2'b01: Aux2 sensor is waiting to be enabled.

KXG03 is attempting to enable aux sensor via enable sequence.

2'b10: Aux2 sensor is waiting to be disabled.

KXG03 is attempting to disable aux sensor via disable sequence.

2'b11: Aux2 sensor is running.

KXG03 has successfully sent aux enable cmd.

**AUX2ERR** – Aux2 data read error flag.

0: No error detected.

1: Missing ACK detected during aux2 polling. KXG03 will retry polling aux device at next scheduled ODR period.

Flag is cleared by writing (any value) into AUX\_STATUS register.

**AUX2FAIL** – Aux2 command sequence failure flag.

0: No failure detected.

1: Missing ACK detected after writing control register address to aux2 device during enable/disable command sequence. KXG03 will suspend aux1 communications until AUX2FAIL bit is cleared by user.

Flag is cleared by writing (any value) into AUX\_STATUS register.

|   |  |                    |
|---|--|--------------------|
|  | <b>Digital Tri-axis Gyroscope/ Tri-axis Accelerometer Specifications</b> | <b>PART NUMBER</b> |
|   |  | KXG03-1034         |
|   |  | Rev. 2.0           |
|   |  | 14-Feb-17          |

**WHO\_AM\_I**

This register can be used for supplier recognition, as it can be factory written to a known byte value. The default value is 0x24.

|          |      |      |      |      |      |      |      |             |
|----------|------|------|------|------|------|------|------|-------------|
| R        | R    | R    | R    | R    | R    | R    | R    |             |
| WIA7     | WIA6 | WIA5 | WIA4 | WIA3 | WIA2 | WIA1 | WIA0 | Reset Value |
| Bit7     | Bit6 | Bit5 | Bit4 | Bit3 | Bit2 | Bit1 | Bit0 | 00100100    |
| Address: |      |      |      |      |      |      | 0x30 |             |

**SN**

Individual Identification (serial number). Data bytes SN\_1, SN\_2, SN\_3, SN\_4.

|          |      |      |      |      |      |      |             |  |
|----------|------|------|------|------|------|------|-------------|--|
| R/W      | R/W  | R/W  | R/W  | R/W  | R/W  | R/W  | R/W         |  |
| SN7      | SN6  | SN5  | SN4  | SN3  | SN2  | SN1  | SN0         |  |
| SN15     | SN14 | SN13 | SN12 | SN11 | SN10 | SN9  | SN8         |  |
| SN23     | SN22 | SN21 | SN20 | SN19 | SN18 | SN17 | SN16        |  |
| SN31     | SN30 | SN29 | SN28 | SN27 | SN26 | SN25 | SN24        |  |
| Bit7     | Bit6 | Bit5 | Bit4 | Bit3 | Bit2 | Bit1 | Bit0        |  |
| Address: |      |      |      |      |      |      | 0x31 – 0x34 |  |

**STATUS1**

Status register 1. GYRO\_START = 1 and GYRO\_RUN = 0 at system startup and go to GYRO\_START = 0 and GYRO\_RUN = 1 as the output rate signals become valid; permanent GYRO\_START = 1 and GYRO\_RUN = 0 indicate a damage in the device.

|          |      |          |          |         |            |          |            |             |
|----------|------|----------|----------|---------|------------|----------|------------|-------------|
| R        | R    | R        | R        | R       | R          | R        | R          |             |
| INT1     | POR  | AUX2_ACT | AUX1_ACT | AUX_ERR | WAKE/SLEEP | GYRO_RUN | GYRO_START | Reset Value |
| Bit7     | Bit6 | Bit5     | Bit4     | Bit3    | Bit2       | Bit1     | Bit0       | 01000100    |
| Address: |      |          |          |         |            |          | 0x36       |             |

**INT1** - reports Logical OR of non-masked interrupt sources sent to INT1 pin.

0: No interrupt event.

1: Interrupt event.

**POR** - Reset indicator.

0: No reset has occurred since register was last read.

1: KXG03 has exited reset phase.

This bit is automatically cleared when the status register is read.



|   |  |  |
|---|--|--|
|  | <b>Digital Tri-axis Gyroscope/ Tri-axis Accelerometer Specifications</b> | <b>PART NUMBER</b><br>KXG03-1034<br>Rev. 2.0<br><b>14-Feb-17</b> |
|---|--|--|

**AUX2\_ACT** - Auxiliary sensor #2 active flag.

0: Aux2 is not active. Aux2 has completed its disable sequence and is in standby mode.

1: Aux2 active. Aux2 has completed its enable sequence and is in active mode.

**AUX1\_ACT** - Auxiliary sensor #1 active flag.

0: Aux1 is not active. Aux1 has completed its disable sequence and is in standby mode.

1: Aux1 active. Aux1 has completed its enable sequence and is in active mode.

**AUX\_ERR** - Auxiliary communications error.

0: No aux communication error detected.

1: Aux communication error (missing ACK) detected.

Note:

- The user should read aux\_stat register to determine state of aux sensors upon aux error detection.
- The flag can be cleared through writing any value to AUX\_STATUS register

**WAKE/SLEEP** - Wake/sleep status flag.

0: Sleep mode.

1: Wake mode.

**GYRO\_RUN** - Gyroscope run flag.

0: control loop has not locked.

1: control loop has locked and gyroscope is active.

**GYRO\_START** - Gyroscope start-up flag.

0: Gyro not in start-up mode.

1: Start-up mode.

|   |  |                    |
|---|--|--------------------|
|  | <b>Digital Tri-axis Gyroscope/ Tri-axis Accelerometer Specifications</b> | <b>PART NUMBER</b> |
|   |  | <b>KXG03-1034</b>  |
|   |  | <b>Rev. 2.0</b>    |
|   |  | <b>14-Feb-17</b>   |

**INT1\_SRC1**

Interrupt 1 source register 1

|               |          |           |          |                |                |                   |                |             |  |
|---------------|----------|-----------|----------|----------------|----------------|-------------------|----------------|-------------|--|
| R             | R        | R         | R        | R              | R              | R                 | R              | R           |  |
| INT1_BFI      | INT1_WMI | INT1_WUFS | INT1_BTS | INT1_DRDY_AUX2 | INT1_DRDY_AUX1 | INT1_DRDY_ACCTEMP | INT1_DRDY_GYRO | Reset Value |  |
| Bit7          | Bit6     | Bit5      | Bit4     | Bit3           | Bit2           | Bit1              | Bit0           | 00000000    |  |
| Address: 0x37 |          |           |          |                |                |                   |                |             |  |

**INT1\_BFI** - Buffer full interrupt.

0: Buffer is not full.

1: Buffer is full.

This bit is cleared when the int1\_I register is read or when the buffer full condition ceases to exist.

Please note: Re-enabling the buffer after the buffer had been disabled during a BFI event can cause the KXG03 to briefly output a false BFI flag.

**INT1\_WMI** - Buffer water mark interrupt.

0: Watermark has not been reached.

1: Watermark has been reached.

This bit is cleared when the int1\_I register is read or when the water mark condition ceases to exist.

Please note: Re-enabling the buffer after the buffer had been disabled during a WMI event can cause the KXG03 to briefly output a false WMI flag.

**INT1\_WUFS** - Wake-up function interrupt.

0: No Wake-up event detected.

1: Wake-up event detected.

This bit is cleared when the int1\_I register is read.

**INT1\_BTS** – Back-to-sleep interrupt.

0: No back-to-sleep event detected.

1: Back-to-sleep event detected.

This bit is cleared when the int1\_I register is read.

**INT1\_DRDY\_AUX2** - Aux2 data ready interrupt.

0: New sensor data is not ready.

1: New sensor data is ready.

This bit is cleared when the int1\_I register or when the aux2\_out1 register is read.

**INT1\_DRDY\_AUX1** – Aux1 data ready interrupt.

0: New sensor data is not ready.

|   |  |   |
|---|--|---|
|  | <b>Digital Tri-axis Gyroscope/ Tri-axis Accelerometer Specifications</b> | <b>PART NUMBER</b><br>KXG03-1034<br>Rev. 2.0<br>14-Feb-17 |
|---|--|---|

1: New sensor data is ready.  
 This bit is cleared when the *int1\_l* register or when the *aux1\_out1* register is read.

**INT1\_DRDY\_ACCTEMP** – Accelerometer / Temperature data ready interrupt.

0: New sensor data is not ready.  
 1: New sensor data is ready.

Note: With both accel and die temp enabled simultaneously, the die temp data updates at the same time as the accel data. With the accel disabled the availability of new die temp data uses the *drdy\_acctemp* interrupt.

This bit is cleared when the *int1\_l* register or when the *acc\_xout\_l* register (x06) is read or when *temp\_out\_l* is read (if accel disabled).

**INT1\_DRDY\_GYRO** – Gyro data ready interrupt.

0: New sensor data is not ready.  
 1: New sensor data is ready.

This bit is cleared when the *int1\_l* register or when the *gyro\_xout\_l* register (x00) is read.

**INT1\_SRC2**

Interrupt 1 source register 2

|               |          |           |           |           |           |           |           |             |
|---------------|----------|-----------|-----------|-----------|-----------|-----------|-----------|-------------|
| R             | R        | R         | R         | R         | R         | R         | R         |             |
| Reserved      | Reserved | INT1_XNWU | INT1_XPWU | INT1_YNWU | INT1_YPWU | INT1_ZNWU | INT1_ZPWU | Reset Value |
| Bit7          | Bit6     | Bit5      | Bit4      | Bit3      | Bit2      | Bit1      | Bit0      | 00000000    |
| Address: 0x38 |          |           |           |           |           |           |           |             |

**INT1\_XNWU** - WUF directional indicator bit.

0: no interrupt event.  
 1: Wake-up event detected on x-axis, negative direction.

**INT1\_XPWU** - WUF directional indicator bit.

0: no interrupt event.  
 1: Wake-up event detected on x-axis, positive direction.

**INT1\_YNWU** - WUF directional indicator bit.

0: no interrupt event.  
 1: Wake-up event detected on y-axis, negative direction.

**INT1\_YPWU** – WUF directional indicator bit.

0: no interrupt event.



# Digital Tri-axis Gyroscope/ Tri-axis Accelerometer Specifications

PART NUMBER

KXG03-1034

Rev. 2.0

14-Feb-17

1: Wake-up event detected on y-axis, positive direction.

**INT1\_ZNWU** - WUF directional indicator bit.

0: no interrupt event.

1: Wake-up event detected on z-axis, negative direction.

**INT1\_ZPWU** – WUF directional indicator bit.

0: no interrupt event.

1: Wake-up event detected on z-axis, positive direction.

## INT1\_L

Interrupt 1 Latch Release – Reading the interrupt1 latch release register clears the interrupt1 source (int1\_src1 and int1\_src2) registers. Reading int1\_l returns x00 in user mode.

|      |      |      |      |      |      |      |               |
|------|------|------|------|------|------|------|---------------|
| R    | R    | R    | R    | R    | R    | R    | R             |
| 0    | 0    | 0    | 0    | 0    | 0    | 0    | 0             |
| Bit7 | Bit6 | Bit5 | Bit4 | Bit3 | Bit2 | Bit1 | Bit0          |
|      |      |      |      |      |      |      | Address: 0x39 |

## STATUS2

Status register 2. GYRO\_START = 1 and GYRO\_RUN = 0 at system startup and go to GYRO\_START = 0 and GYRO\_RUN = 1 as the output rate signals become valid; permanent GYRO\_START = 1 and GYRO\_RUN = 0 indicate a damage in the device.

|      |      |          |          |         |            |          |            |             |
|------|------|----------|----------|---------|------------|----------|------------|-------------|
| R    | R    | R        | R        | R       | R          | R        | R          |             |
| INT2 | POR  | AUX2_ACT | AUX1_ACT | AUX_ERR | WAKE/SLEEP | GYRO_RUN | GYRO_START | Reset Value |
| Bit7 | Bit6 | Bit5     | Bit4     | Bit3    | Bit2       | Bit1     | Bit0       | 01000100    |
|      |      |          |          |         |            |          | Address:   | 0x3A        |

**INT2** - reports Logical OR of non-masked interrupt sources sent to INT2 pin.

0: No interrupt event.

1: Interrupt event.

**POR** - Reset indicator.

0: No reset has occurred since register was last read.

1: KXG03 has exited reset phase.

This bit is automatically cleared when the status register is read.

**AUX2\_ACT** - Auxiliary sensor #2 active flag.

0: Aux2 is not active. Aux2 has completed its disable sequence and is in standby mode.

1: Aux2 active. Aux2 has completed its enable sequence and is in active mode.



# Digital Tri-axis Gyroscope/ Tri-axis Accelerometer Specifications

**PART NUMBER**

**KXG03-1034**

**Rev. 2.0**

**14-Feb-17**

**AUX1\_ACT** - Auxiliary sensor #1 active flag.

0: Aux1 is not active. Aux1 has completed its disable sequence and is in standby mode.

1: Aux1 active. Aux1 has completed its enable sequence and is in active mode.

**AUX\_ERR** - Auxiliary communications error.

0: No aux communication error detected.

1: Aux co communication mm error (missing ACK) detected.

Note: The user should read aux\_stat register to determine state of aux sensors upon aux error detection.

**WAKE/SLEEP** - Wake/sleep status flag.

0: Sleep mode.

1: Wake mode.

**GYRO\_START** - Gyroscope start-up flag.

0: Gyro not in startup mode.

1: Start up mode.

**GYRO\_RUN** - Gyroscope run flag.

0: control loop has not locked.

1: control loop has locked and gyroscope is active.

## INT2\_SRC1

Interrupt 2 source register 1

| R             | R        | R         | R        | R              | R              | R                 | R              | Reset Value |
|---------------|----------|-----------|----------|----------------|----------------|-------------------|----------------|-------------|
| INT2_BFI      | INT2_WMI | INT2_WUFS | INT2_BTS | INT2_DRDY_AUX2 | INT2_DRDY_AUX1 | INT2_DRDY_ACCTEMP | INT2_DRDY_GYRO | 00000000    |
| Bit7          | Bit6     | Bit5      | Bit4     | Bit3           | Bit2           | Bit1              | Bit0           |             |
| Address: 0x3B |          |           |          |                |                |                   |                |             |

**INT2\_BFI** - Buffer full interrupt.

0: Buffer is not full.

1: Buffer is full.

This bit is cleared when the int2\_l register is read or when the buffer full condition ceases to exist.

Please note: Re-enabling the buffer after the buffer had been disabled during a BFI event can cause the KXG03 to briefly output a false BFI flag.

**INT2\_WMI** - Buffer water mark interrupt.

|   |  |   |
|---|--|---|
|  | <b>Digital Tri-axis Gyroscope/ Tri-axis Accelerometer Specifications</b> | <b>PART NUMBER</b><br><b>KXG03-1034</b><br>Rev. 2.0<br><b>14-Feb-17</b> |
|---|--|---|

0: Watermark has not been reached.  
1: Watermark has been reached.  
This bit is cleared when the *int2\_I* register is read or when the water mark condition ceases to exist.  
Please note: Re-enabling the buffer after the buffer had been disabled during a WMI event can cause the KXG03 to briefly output a false WMI flag.

**INT2\_WUFS** - Wake-up function interrupt.  
0: No Wake-up event detected.  
1: Wake-up event detected.  
This bit is cleared when the *int2\_I* register is read.

**INT2\_BTS** – Back-to-sleep interrupt.  
0: No back-to-sleep event detected.  
1: Back-to-sleep event detected.  
This bit is cleared when the *int2\_I* register is read.

**INT2\_DRDY\_AUX2** - Aux2 data ready interrupt.  
0: New sensor data is not ready.  
1: New sensor data is ready.  
This bit is cleared when the *int2\_I* register or when the *aux2\_out1* register is read.

**INT2\_DRDY\_AUX1** – Aux1 data ready interrupt.  
0: New sensor data is not ready.  
1: New sensor data is ready.  
This bit is cleared when the *int2\_I* register or when the *aux1\_out1* register is read.

**INT2\_DRDY\_ACCTEMP** – Accelerometer data ready interrupt.  
0: New sensor data is not ready.  
1: New sensor data is ready.  
Note: With both accel and die temp enabled simultaneously, the die temp data updates at the same time as the accel data. With the accel disabled the availability of new die temp data uses the *drdy\_acctemp* interrupt.  
This bit is cleared when the *int2\_I* register or when the *acc\_xout\_I* register (x06) is read or when *temp\_out\_I* is read (if accel disabled).

**INT2\_DRDY\_GYRO** – Gyro data ready interrupt.  
0: New sensor data is not ready.  
1: New sensor data is ready.  
This bit is cleared when the *int2\_I* register or when the *gyro\_xout\_I* register (x00) is read.

|   |  |                    |
|---|--|--------------------|
|  | <b>Digital Tri-axis Gyroscope/ Tri-axis Accelerometer Specifications</b> | <b>PART NUMBER</b> |
|   |  | KXG03-1034         |
|   |  | Rev. 2.0           |
|   |  | 14-Feb-17          |

**INT2\_SRC2**

Interrupt 2 source register 2

|               |          |           |           |           |           |           |           |             |
|---------------|----------|-----------|-----------|-----------|-----------|-----------|-----------|-------------|
| R             | R        | R         | R         | R         | R         | R         | R         | R           |
| Reserved      | Reserved | INT2_XNWU | INT2_XPWU | INT2_YNWU | INT2_YPWU | INT2_ZNWU | INT2_ZPWU | Reset Value |
| Bit7          | Bit6     | Bit5      | Bit4      | Bit3      | Bit2      | Bit1      | Bit0      | 00000000    |
| Address: 0x3C |          |           |           |           |           |           |           |             |

**INT2\_XNWU** - WUF directional indicator bit.  
 0: no interrupt event.  
 1: Wake-up event detected on x-axis, negative direction.

**INT2\_XPWU** - WUF directional indicator bit.  
 0: no interrupt event.  
 1: Wake-up event detected on x-axis, positive direction.

**INT2\_YNWU** - WUF directional indicator bit.  
 0: no interrupt event.  
 1: Wake-up event detected on y-axis, negative direction.

**INT2\_YPWU** – WUF directional indicator bit.  
 0: no interrupt event.  
 1: Wake-up event detected on y-axis, positive direction.

**INT2\_ZNWU** - WUF directional indicator bit.  
 0: no interrupt event.  
 1: Wake-up event detected on z-axis, negative direction.

**INT2\_ZPWU** – WUF directional indicator bit.  
 0: no interrupt event.  
 1: Wake-up event detected on z-axis, positive direction.



## Digital Tri-axis Gyroscope/ Tri-axis Accelerometer Specifications

PART NUMBER

KXG03-1034

Rev. 2.0

14-Feb-17

### INT2\_L

Interrupt 2 Latch Release – Reading the interrupt2 latch release register clears the interrupt2 source (int1\_src2 and int2\_src2) registers. Reading int2\_l returns x00 in user mode.

|               |      |      |      |      |      |      |      |
|---------------|------|------|------|------|------|------|------|
| R             | R    | R    | R    | R    | R    | R    | R    |
| 0             | 0    | 0    | 0    | 0    | 0    | 0    | 0    |
| Bit7          | Bit6 | Bit5 | Bit4 | Bit3 | Bit2 | Bit1 | Bit0 |
| Address: 0x3D |      |      |      |      |      |      |      |

### ACCEL\_ODR\_WAKE

Accelerometer Wake Mode Control register.

|               |         |         |         |         |         |         |         |             |
|---------------|---------|---------|---------|---------|---------|---------|---------|-------------|
| R/W           | R/W     | R/W     | R/W     | R/W     | R/W     | R/W     | R/W     |             |
| LPMODE_W      | NAVW_W2 | NAVW_W1 | NAVW_W0 | ODRA_W3 | ODRA_W2 | ODRA_W1 | ODRA_W0 | Reset Value |
| Bit7          | Bit6    | Bit5    | Bit4    | Bit3    | Bit2    | Bit1    | Bit0    | 11010110    |
| Address: 0x3E |         |         |         |         |         |         |         |             |

#### **LPMODE\_W** - Accelerometer wake state low power mode enable

0: Accelerometer low power mode is disabled in wake state.

Accelerometer operates at max sampling rate and navg\_wake is ignored

1: Accelerometer low power mode is enabled in wake state

Accelerometer operates in duty cycle mode with number of samples set by navg\_wake

Note: The LPMODE\_W = 1 setting would be ignored and device would not operate in duty cycle mode when ODR for either accelerometer or gyro is set for 400Hz or higher.

**NAVW\_W[2:0]:** Accelerometer wake mode OSR control. The max over sampling rate (or max number of samples averaged) varies with ODR.

| [2] | [1] | [0] | Number of Averages |
|-----|-----|-----|--------------------|
| 0   | 0   | 0   | 1                  |
| 0   | 0   | 1   | 2                  |
| 0   | 1   | 0   | 4                  |
| 0   | 1   | 1   | 8                  |
| 1   | 0   | 0   | 16                 |
| 1   | 0   | 1   | 32                 |
| 1   | 1   | 0   | 64                 |
| 1   | 1   | 1   | 128                |





# Digital Tri-axis Gyroscope/ Tri-axis Accelerometer Specifications

PART NUMBER

KXG03-1034

Rev. 2.0

14-Feb-17

**ODRA\_W[3:0]:** Determines accelerometer ODR in wake mode

| [3] | [2] | [1] | [0] | Output Data Rate |
|-----|-----|-----|-----|------------------|
| 0   | 0   | 0   | 0   | 0.781Hz          |
| 0   | 0   | 0   | 1   | 1.563Hz          |
| 0   | 0   | 1   | 0   | 3.125Hz          |
| 0   | 0   | 1   | 1   | 6.25Hz           |
| 0   | 1   | 0   | 0   | 12.5Hz           |
| 0   | 1   | 0   | 1   | 25Hz             |
| 0   | 1   | 1   | 0   | 50Hz             |
| 0   | 1   | 1   | 1   | 100Hz            |
| 1   | 0   | 0   | 0   | 200Hz            |
| 1   | 0   | 0   | 1   | 400Hz            |
| 1   | 0   | 1   | 0   | 800Hz            |
| 1   | 0   | 1   | 1   | 1600Hz           |
| 1   | 1   | 0   | 0   | 3200Hz           |
| 1   | 1   | 0   | 1   | 6400Hz           |
| 1   | 1   | 1   | 0   | 12800Hz          |
| 1   | 1   | 1   | 1   | 51200Hz          |

## ACCEL\_ODR\_SLEEP

Accelerometer Wake Mode Control register.

| R/W      | R/W      | R/W      | R/W      | R/W     | R/W     | R/W     | R/W      | Reset Value |
|----------|----------|----------|----------|---------|---------|---------|----------|-------------|
| LPMODE_S | NAV_G_S2 | NAV_G_S1 | NAV_G_S0 | ODRA_S3 | ODRA_S2 | ODRA_S1 | ODRA_S0  | 11010110    |
| Bit7     | Bit6     | Bit5     | Bit4     | Bit3    | Bit2    | Bit1    | Bit0     |             |
|          |          |          |          |         |         |         | Address: | 0x3F        |

**LPMODE\_S** - Accelerometer sleep state low power mode enable

0: Accelerometer low power mode is disabled in sleep state

Accelerometer operates at max sampling rate and *navg\_sleep* is ignored

1: Accelerometer low power mode is enabled in sleep state

Accelerometer operates in duty cycle mode with number of samples set by *navg\_sleep*

Note: The LPMODE\_S = 1 setting would be ignored and device would not operate in duty cycle mode when ODR for either accelerometer or gyro is set for 400Hz or higher.



## Digital Tri-axis Gyroscope/ Tri-axis Accelerometer Specifications

PART NUMBER

KXG03-1034

Rev. 2.0

14-Feb-17

**NAVGS[2:0]:** Accelerometer sleep mode OSR control. The max over sampling rate (or max number of samples averaged) varies with ODR.

| [2] | [1] | [0] | Number of Averages |
|-----|-----|-----|--------------------|
| 0   | 0   | 0   | 1                  |
| 0   | 0   | 1   | 2                  |
| 0   | 1   | 0   | 4                  |
| 0   | 1   | 1   | 8                  |
| 1   | 0   | 0   | 16                 |
| 1   | 0   | 1   | 32                 |
| 1   | 1   | 0   | 64                 |
| 1   | 1   | 1   | 128                |

**ODRAS[3:0]:** Determines accelerometer ODR in sleep mode

| [3] | [2] | [1] | [0] | Output Data Rate |
|-----|-----|-----|-----|------------------|
| 0   | 0   | 0   | 0   | 0.781Hz          |
| 0   | 0   | 0   | 1   | 1.563Hz          |
| 0   | 0   | 1   | 0   | 3.125Hz          |
| 0   | 0   | 1   | 1   | 6.25Hz           |
| 0   | 1   | 0   | 0   | 12.5Hz           |
| 0   | 1   | 0   | 1   | 25Hz             |
| 0   | 1   | 1   | 0   | 50Hz             |
| 0   | 1   | 1   | 1   | 100Hz            |
| 1   | 0   | 0   | 0   | 200Hz            |
| 1   | 0   | 0   | 1   | 400Hz            |
| 1   | 0   | 1   | 0   | 800Hz            |
| 1   | 0   | 1   | 1   | 1600Hz           |
| 1   | 1   | 0   | 0   | 3200Hz           |
| 1   | 1   | 0   | 1   | 6400Hz           |
| 1   | 1   | 1   | 0   | 12800Hz          |
| 1   | 1   | 1   | 1   | 51200Hz          |

|   |  |                    |
|---|--|--------------------|
|  | <b>Digital Tri-axis Gyroscope/ Tri-axis Accelerometer Specifications</b> | <b>PART NUMBER</b> |
|   |  | KXG03-1034         |
|   |  | Rev. 2.0           |
|   |  | 14-Feb-17          |

**ACCEL\_CTL**

Accelerometer range control register.

|               |           |          |          |           |           |          |          |             |
|---------------|-----------|----------|----------|-----------|-----------|----------|----------|-------------|
| R/W           | R/W       | R/W      | R/W      | R/W       | R/W       | R/W      | R/W      | Reset Value |
| ACC_FS_S1     | ACC_FS_S0 | Reserved | Reserved | ACC_FS_W1 | ACC_FS_W0 | Reserved | Reserved | 00000000    |
| Bit7          | Bit6      | Bit5     | Bit4     | Bit3      | Bit2      | Bit1     | Bit0     |             |
| Address: 0x40 |           |          |          |           |           |          |          |             |

**ACC\_FS\_S[1:0]** Accelerometer sleep mode full scale range select

- 2'b00: ± 2 g
- 2'b01: ± 4 g,
- 2'b10: ± 8 g,
- 2'b11: ± 16 g

**ACC\_FS\_W[1:0]** Accelerometer wake mode full scale range select

- 2'b00: ± 2 g
- 2'b01: ± 4 g,
- 2'b10: ± 8 g,
- 2'b11: ± 16 g

**GYRO\_ODR\_WAKE**

Gyroscope Wake Mode Control register.

|               |            |            |            |         |         |         |         |             |
|---------------|------------|------------|------------|---------|---------|---------|---------|-------------|
| R/W           | R/W        | R/W        | R/W        | R/W     | R/W     | R/W     | R/W     | Reset Value |
| GYRO_FS_W1    | GYRO_FS_W0 | GYRO_BW_W1 | GYRO_BW_W0 | ODRG_W3 | ODRG_W2 | ODRG_W1 | ODRG_W0 | 00000110    |
| Bit7          | Bit6       | Bit5       | Bit4       | Bit3    | Bit2    | Bit1    | Bit0    |             |
| Address: 0x41 |            |            |            |         |         |         |         |             |

**GYRO\_FS\_W[1:0]:** Gyroscope angular velocity range wake mode

| [1] | [0] | Range |
|-----|-----|-------|
| 0   | 0   | ±256  |
| 0   | 1   | ±512  |
| 1   | 0   | ±1024 |
| 1   | 1   | ±2048 |



# Digital Tri-axis Gyroscope/ Tri-axis Accelerometer Specifications

PART NUMBER

KXG03-1034

Rev. 2.0

14-Feb-17

**GYRO\_BW\_W[1:0]:** Gyroscope bandwidth selection in wake mode

| [1] | [0] | BW     |
|-----|-----|--------|
| 0   | 0   | 10 Hz  |
| 0   | 1   | 20 Hz  |
| 1   | 0   | 40 Hz  |
| 1   | 1   | 160 Hz |

**ODRG\_W[3:0]:** Determines gyroscope ODR in wake mode

| [3] | [2] | [1] | [0] | Output Data Rate |
|-----|-----|-----|-----|------------------|
| 0   | 0   | 0   | 0   | 0.781Hz          |
| 0   | 0   | 0   | 1   | 1.563Hz          |
| 0   | 0   | 1   | 0   | 3.125Hz          |
| 0   | 0   | 1   | 1   | 6.25Hz           |
| 0   | 1   | 0   | 0   | 12.5Hz           |
| 0   | 1   | 0   | 1   | 25Hz             |
| 0   | 1   | 1   | 0   | 50Hz             |
| 0   | 1   | 1   | 1   | 100Hz            |
| 1   | 0   | 0   | 0   | 200Hz            |
| 1   | 0   | 0   | 1   | 400Hz            |
| 1   | 0   | 1   | 0   | 800Hz            |
| 1   | 0   | 1   | 1   | 1600Hz           |
| 1   | 1   | 0   | 0   | 1600Hz           |
| 1   | 1   | 0   | 1   | 1600Hz           |
| 1   | 1   | 1   | 0   | 1600Hz           |
| 1   | 1   | 1   | 1   | 1600Hz           |



# Digital Tri-axis Gyroscope/ Tri-axis Accelerometer Specifications

**PART NUMBER**

**KXG03-1034**

**Rev. 2.0**

**14-Feb-17**

## **GYRO\_ODR\_SLEEP**

Gyroscope Sleep Mode Control register.

| R/W           | R/W        | R/W        | R/W        | R/W     | R/W     | R/W     | R/W     |             |
|---------------|------------|------------|------------|---------|---------|---------|---------|-------------|
| GYRO_FS_S1    | GYRO_FS_S0 | GYRO_BW_S1 | GYRO_BW_S0 | ODRG_S3 | ODRG_S2 | ODRG_S1 | ODRG_S0 | Reset Value |
| Bit7          | Bit6       | Bit5       | Bit4       | Bit3    | Bit2    | Bit1    | Bit0    | 00000110    |
| Address: 0x42 |            |            |            |         |         |         |         |             |

***GYRO\_FS\_S[1:0]: Gyroscope angular velocity range in sleep mode***

| [1] | [0] | Range |
|-----|-----|-------|
| 0   | 0   | ±256  |
| 0   | 1   | ±512  |
| 1   | 0   | ±1024 |
| 1   | 1   | ±2048 |

***GYRO\_BW\_S[1:0]: Gyroscope bandwidth selection in sleep mode***

| [1] | [0] | BW     |
|-----|-----|--------|
| 0   | 0   | 10 Hz  |
| 0   | 1   | 20 Hz  |
| 1   | 0   | 40 Hz  |
| 1   | 1   | 160 Hz |



# Digital Tri-axis Gyroscope/ Tri-axis Accelerometer Specifications

**PART NUMBER**

**KXG03-1034**

**Rev. 2.0**

**14-Feb-17**

*ODRG\_S[3:0]: Determines gyroscope ODR in sleep mode*

| [3] | [2] | [1] | [0] | Output Data Rate |
|-----|-----|-----|-----|------------------|
| 0   | 0   | 0   | 0   | 0.781Hz          |
| 0   | 0   | 0   | 1   | 1.563Hz          |
| 0   | 0   | 1   | 0   | 3.125Hz          |
| 0   | 0   | 1   | 1   | 6.25Hz           |
| 0   | 1   | 0   | 0   | 12.5Hz           |
| 0   | 1   | 0   | 1   | 25Hz             |
| 0   | 1   | 1   | 0   | 50Hz             |
| 0   | 1   | 1   | 1   | 100Hz            |
| 1   | 0   | 0   | 0   | 200Hz            |
| 1   | 0   | 0   | 1   | 400Hz            |
| 1   | 0   | 1   | 0   | 800Hz            |
| 1   | 0   | 1   | 1   | 1600Hz           |
| 1   | 1   | 0   | 0   | 1600Hz           |
| 1   | 1   | 0   | 1   | 1600Hz           |
| 1   | 1   | 1   | 0   | 1600Hz           |
| 1   | 1   | 1   | 1   | 1600Hz           |

|   |  |                    |
|---|--|--------------------|
|  | <b>Digital Tri-axis Gyroscope/ Tri-axis Accelerometer Specifications</b> | <b>PART NUMBER</b> |
|   |  | KXG03-1034         |
|   |  | Rev. 2.0           |
|   |  | 14-Feb-17          |

**STDBY**

Stand-by and operational control register. KXG03 register settings can be applied prior to enabling the Accel or Gyro. Enabling the sensor “locks in” the user register settings. Altering register settings after enable is not recommended.

| R/W              | R/W              | R/W              | R/W      | R/W              | R/W              | R/W              | R/W       |             |
|------------------|------------------|------------------|----------|------------------|------------------|------------------|-----------|-------------|
| AUX2_STD<br>BY_S | AUX1_STD<br>BY_S | GYRO_STD<br>BY_S | Reserved | AUX2_STD<br>BY_W | AUX1_STD<br>BY_W | GYRO_STD<br>BY_W | ACC_STDBY | Reset Value |
| Bit7             | Bit6             | Bit5             | Bit4     | Bit3             | Bit2             | Bit1             | Bit0      | 11101111    |
| Address: 0x43    |                  |                  |          |                  |                  |                  |           |             |

**AUX2\_STDBY\_S** - Active LOW aux2 sensor enable

0: Aux2 sensor is enabled in sleep state

1: Aux2 sensor is disabled in sleep state

**AUX1\_STDBY\_S** - Active LOW aux1 sensor enable

0: Aux1 sensor is enabled in sleep state

1: Aux1 sensor is disabled in sleep state

**GYRO\_STDBY\_S** - Active LOW gyroscope sensor enable

0: Gyro sensor is enabled in sleep state

1: Gyro sensor is disabled in sleep state

**AUX2\_STDBY\_W** - Active LOW aux2 sensor enable

0: Aux2 sensor is enabled in wake state

1: Aux2 sensor is disabled in wake state

**AUX1\_STDBY\_W** - Active LOW aux1 sensor enable

0: Aux1 sensor is enabled in wake state

1: Aux1 sensor is disabled in wake state

**GYRO\_STDBY\_W** - Active LOW gyroscope sensor enable

0: Gyro sensor is enabled in wake state

1: Gyro sensor is disabled in wake state

**ACC\_STDBY** - Active LOW Accelerometer sensor enable.

0: Accelerometer sensor is enabled

1: Accelerometer sensor is disabled

|   |  |                    |
|---|--|--------------------|
|  | <b>Digital Tri-axis Gyroscope/ Tri-axis Accelerometer Specifications</b> | <b>PART NUMBER</b> |
|   |  | <b>KXG03-1034</b>  |
|   |  | <b>Rev. 2.0</b>    |
|   |  | <b>14-Feb-17</b>   |

**CTL\_REG\_1**

Special control register 1.

| R/W           | R/W      | R/W     | R/W          | R/W          | R/W      | R/W       | R/W    | Reset Value |
|---------------|----------|---------|--------------|--------------|----------|-----------|--------|-------------|
| SRST          | Reserved | I2C_DIS | TEMP_STDBY_S | TEMP_STDBY_W | Reserved | ACC_STPOL | ACC_ST | 00011000    |
| Bit7          | Bit6     | Bit5    | Bit4         | Bit3         | Bit2     | Bit1      | Bit0   |             |
| Address: 0x44 |          |         |              |              |          |           |        |             |

**SRST** - initiates software reset, which performs the RAM reboot routine. This bit will remain 1 until the RAM reboot routine is finished.

SRST = 0 – no action

SRST = 1 – start RAM reboot routine. This bit is self-clearing.

**I2C\_DIS** - Active high I2C disable bit.

0: I2C interface is not disabled.

1: I2C interface is disabled.

Please note the I2C\_DIS control bit defaults to 0 on power up or when exiting reset. The state of this bit can only be changed via SPI communications.

For applications using SPI on a shared bus (multiple slave devices on a single nCS line)

I2C\_DIS should be set 1. Applications using a SPI interface on a dedicated bus (nCS

connects only to KXG03 and not to any other slave devices) can function with I2C\_DIS set to 0 or 1. For applications using I2C interface I2C\_DIS should be set 0.

**TEMP\_STDBY\_S** - Sleep mode temperature output standby bit.

0: Temperature output is enabled in sleep mode.

1: Temperature output is disabled in sleep mode.

Note: Temperature output operates with the same ODR as the Accelerometer.

**TEMP\_STDBY\_W** - Wake mode temperature output standby bit.

0: Temperature output is enabled in wake mode.

1: Temperature output is disabled in wake mode.

Note: Temperature output operates with the same ODR as the Accelerometer.

**ACC\_STPOL** - Defines accelerometer self-test polarity.

0: Accelerometer self-test polarity is not inverted.

1: Accelerometer self-test polarity is inverted.

**ACC\_ST** - Active high accelerometer self-test enable

0: Accelerometer self-test is disabled.

1: Accelerometer self-test is enabled.



|   |  |                    |
|---|--|--------------------|
|  | <b>Digital Tri-axis Gyroscope/ Tri-axis Accelerometer Specifications</b> | <b>PART NUMBER</b> |
|   |  | <b>KXG03-1034</b>  |
|   |  | <b>Rev. 2.0</b>    |
|   |  | <b>14-Feb-17</b>   |

### INT\_PIN\_CTL

This register controls the settings for the physical interrupt pins INT1 and INT2.

| R/W           | R/W  | R/W    | R/W    | R/W  | R/W  | R/W    | R/W    |             |
|---------------|------|--------|--------|------|------|--------|--------|-------------|
| IEN2          | IEA2 | IEL2_1 | IEL2_0 | IEN1 | IEA1 | IEL1_1 | IEL1_0 | Reset Value |
| Bit7          | Bit6 | Bit5   | Bit4   | Bit3 | Bit2 | Bit1   | Bit0   | 01000100    |
| Address: 0x45 |      |        |        |      |      |        |        |             |

**IEN2** - Active high enable for INT2 pin.

0: INT2 pin is disabled and output is forced to non-asserted state.

1: INT2 pin is enabled. Output state is either high or low depending on status of selected interrupt sources.

**IEA2** - Interrupt polarity select for INT2 pin.

0: INT2 is active low. Pin pulls low during interrupt event.

1: INT2 is active high. Pin pulls high during interrupt event.

**IEL2[1:0]**: Interrupt latch mode select for INT2 pin.

2'b00: Latched. Once an interrupt has triggered INT2 remains in its interrupt state defined by IEA2 until the interrupt source has been cleared.

2'b01: Pulsed. Once an interrupt has triggered INT2 remains in its interrupt state defined by IEA2 for an approximate period of 40 us before returning to the non-interrupt state.

2'b10: Pulsed. Once an interrupt has triggered INT2 remains in its interrupt state defined by IEA2 for an approximate period of 160 us before returning to the non-interrupt state.

2'b11: Real time mode. INT2 only remains asserted as long as underlying interrupt conditions exist.

**IEN1** - Active high enable for INT1 pin.

0: INT1 pin is disabled and output is forced to non-asserted state.

1: INT1 pin is enabled. Output state is either high or low depending on status of selected interrupt sources.

**IEA1** - Interrupt polarity select for INT1 pin.

0: INT1 is active low. Pin pulls low during interrupt event.

1: INT1 is active high. Pin pulls high during interrupt event.

**IEL1[1:0]**: Interrupt latch mode select for INT1 pin.

2'b00: Latched. Once an interrupt has triggered INT1 remains in its interrupt state defined by IEA2 until the interrupt source has been cleared.

2'b01: Pulsed. Once an interrupt has triggered INT1 remains in its interrupt state defined by IEA2 for an approximate period of 40 us before returning to the non-interrupt state.



## Digital Tri-axis Gyroscope/ Tri-axis Accelerometer Specifications

PART NUMBER

KXG03-1034

Rev. 2.0

14-Feb-17

2'b10: Pulsed. Once an interrupt has triggered INT1 remains in its interrupt state defined by IEA2 for an approximate period of 160 us before returning to the non-interrupt state.

2'b11: Real time mode. INT1 only remains asserted as long as underlying interrupt conditions exist.

### INT\_PIN1\_SEL

Physical interrupt pin INT1 select register.

| R/W           | R/W    | R/W    | R/W    | R/W          | R/W          | R/W              | R/W          | Reset Value |
|---------------|--------|--------|--------|--------------|--------------|------------------|--------------|-------------|
| BFI_P1        | WMI_P1 | WUF_P1 | BTS_P1 | DRDY_AUX2_P1 | DRDY_AUX1_P1 | DRDY_ACCT_EMP_P1 | DRDY_GYRO_P1 | 11111111    |
| Bit7          | Bit6   | Bit5   | Bit4   | Bit3         | Bit2         | Bit1             | Bit0         |             |
| Address: 0x46 |        |        |        |              |              |                  |              |             |

**BFI\_P1** – Buffer Full Interrupt for INT1 pin.

0: Corresponding interrupt is not routed to INT1 pin.

1: Corresponding interrupt is routed to INT1 pin.

**WMI\_P1** – Water Mark Interrupt for INT1 pin.

0: Corresponding interrupt is not routed to INT1 pin.

1: Corresponding interrupt is routed to INT1 pin.

**WUF\_P1** – Wake-up Function Interrupt for INT1 pin.

0: Corresponding interrupt is not routed to INT1 pin.

1: Corresponding interrupt is routed to INT1 pin.

**BTS\_P1** – Back-to-sleep Function Interrupt for INT1 pin.

0: Corresponding interrupt is not routed to INT1 pin.

1: Corresponding interrupt is routed to INT1 pin.

**DRDY\_AUX2\_P1** – Data Ready Aux2 Interrupt for INT1 pin.

0: Corresponding interrupt is not routed to INT1 pin.

1: Corresponding interrupt is routed to INT1 pin.

**DRDY\_AUX1\_P1** – Data Ready AUX1 Interrupt for INT1 pin.

0: Corresponding interrupt is not routed to INT1 pin.

1: Corresponding interrupt is routed to INT1 pin.

**DRDY\_ACCTEMP\_P1** – Data Ready Accelerometer / Temperature Interrupt for INT1 pin.

0: Corresponding interrupt is not routed to INT1 pin.

1: Corresponding interrupt is routed to INT1 pin.

|   |  |                    |
|---|--|--------------------|
|  | <b>Digital Tri-axis Gyroscope/ Tri-axis Accelerometer Specifications</b> | <b>PART NUMBER</b> |
|   |  | KXG03-1034         |
|   |  | Rev. 2.0           |
|   |  | 14-Feb-17          |

**DRDY\_GYRO\_P1** – Data Ready Gyroscope Interrupt for INT1 pin.  
0: Corresponding interrupt is not routed to INT1 pin.  
1: Corresponding interrupt is routed to INT1 pin.

**INT\_PIN2\_SEL**

Physical interrupt pin INT2 select register.

|               |        |        |        |              |              |                 |              |             |
|---------------|--------|--------|--------|--------------|--------------|-----------------|--------------|-------------|
| R/W           | R/W    | R/W    | R/W    | R/W          | R/W          | R/W             | R/W          | Reset Value |
| BFI_P2        | WMI_P2 | WUF_P2 | BTS_P2 | DRDY_AUX2_P2 | DRDY_AUX1_P2 | DRDY_ACCTEMP_P2 | DRDY_GYRO_P2 | 00000000    |
| Bit7          | Bit6   | Bit5   | Bit4   | Bit3         | Bit2         | Bit1            | Bit0         |             |
| Address: 0x47 |        |        |        |              |              |                 |              |             |

**BFI\_P2** – Buffer Full Interrupt for INT2 pin.  
0: Corresponding interrupt is not routed to INT2 pin.  
1: Corresponding interrupt is routed to INT2 pin.

**WMI\_P2** – Water Mark Interrupt for INT2 pin.  
0: Corresponding interrupt is not routed to INT2 pin.  
1: Corresponding interrupt is routed to INT2 pin.

**WUF\_P2** – Wake-up Function Interrupt for INT2 pin.  
0: Corresponding interrupt is not routed to INT2 pin.  
1: Corresponding interrupt is routed to INT2 pin.

**BTS\_P2** – Back-to-sleep Function Interrupt for INT2 pin.  
0: Corresponding interrupt is not routed to INT2 pin.  
1: Corresponding interrupt is routed to INT2 pin.

**DRDY\_AUX2\_P2** – Data Ready Aux2 Interrupt for INT2 pin.  
0: Corresponding interrupt is not routed to INT2 pin.  
1: Corresponding interrupt is routed to INT2 pin.

**DRDY\_AUX1\_P2** – Data Ready AUX1 Interrupt for INT2 pin.  
0: Corresponding interrupt is not routed to INT2 pin.  
1: Corresponding interrupt is routed to INT2 pin.

**DRDY\_ACCTEMP\_P2** – Data Ready Accelerometer / Temperature Interrupt for INT2 pin.  
0: Corresponding interrupt is not routed to INT2 pin.  
1: Corresponding interrupt is routed to INT2 pin.

|   |  |                    |
|---|--|--------------------|
|  | <b>Digital Tri-axis Gyroscope/ Tri-axis Accelerometer Specifications</b> | <b>PART NUMBER</b> |
|   |  | KXG03-1034         |
|   |  | Rev. 2.0           |
|   |  | 14-Feb-17          |

**DRDY\_GYRO\_P2** – Data Ready Gyroscope Interrupt for INT2 pin.  
0: Corresponding interrupt is not routed to INT2 pin.  
1: Corresponding interrupt is routed to INT2 pin.

**INT\_MASK1**

Interrupt mask register 1.

|               |      |      |      |           |           |                  |           |             |
|---------------|------|------|------|-----------|-----------|------------------|-----------|-------------|
| R/W           | R/W  | R/W  | R/W  | R/W       | R/W       | R/W              | R/W       | Reset Value |
| BFIE          | WMIE | WUFE | BTSE | DRDY_AUX2 | DRDY_AUX1 | DRDY_ACCT<br>EMP | DRDY_GYRO | 11000000    |
| Bit7          | Bit6 | Bit5 | Bit4 | Bit3      | Bit2      | Bit1             | Bit0      |             |
| Address: 0x48 |      |      |      |           |           |                  |           |             |

**BFIE** – Buffer Full Interrupt enable/mask bit.  
0: Corresponding interrupt is disabled (masked).  
1: Corresponding interrupt is enabled.

**WMIE** – Water Mark Interrupt enable/mask bit.  
0: Corresponding interrupt is disabled (masked).  
1: Corresponding interrupt is enabled.

**WUFE** – Wake-up Function Interrupt enable/mask bit.  
0: Corresponding interrupt is disabled (masked).  
1: Corresponding interrupt is enabled.

**BTSE** – Back-to-sleep Function Interrupt enable/mask bit.  
0: Corresponding interrupt is disabled (masked). 1: Corresponding interrupt is routed to INT1 pin.

**DRDY\_AUX2** – Data Ready Aux2 Interrupt enable/mask bit.  
0: Corresponding interrupt is disabled (masked).  
1: Corresponding interrupt is enabled.

**DRDY\_AUX1** – Data Ready AUX1 Interrupt enable/mask bit.  
0: Corresponding interrupt is disabled (masked).  
1: Corresponding interrupt is enabled.

**DRDY\_ACCTEMP** – Data Ready Accelerometer / Temperature Interrupt enable/mask bit.  
0: Corresponding interrupt is disabled (masked).  
1: Corresponding interrupt is enabled.

|   |  |                    |
|---|--|--------------------|
|  | <b>Digital Tri-axis Gyroscope/ Tri-axis Accelerometer Specifications</b> | <b>PART NUMBER</b> |
|   |  | KXG03-1034         |
|   |  | Rev. 2.0           |
|   |  | 14-Feb-17          |

**DRDY\_GYRO** – Data Ready Gyroscope Interrupt enable/mask bit.  
0: Corresponding interrupt is disabled (masked).  
1: Corresponding interrupt is enabled.

**INT\_MASK2**

Interrupt mask register 2. This register controls which axis and direction of detected motion can cause an interrupt.

|               |          |       |       |       |       |       |       |             |
|---------------|----------|-------|-------|-------|-------|-------|-------|-------------|
| R/W           | R/W      | R/W   | R/W   | R/W   | R/W   | R/W   | R/W   |             |
| Reserved      | Reserved | XNWUE | XPWUE | YNWUE | YPWUE | ZNWUE | ZPWUE | Reset Value |
| Bit7          | Bit6     | Bit5  | Bit4  | Bit3  | Bit2  | Bit1  | Bit0  | 00111111    |
| Address: 0x49 |          |       |       |       |       |       |       |             |

**NXWUE** - x negative (x-) mask for WUF/BTS, 0=disable, 1=enable.  
**PXWUE** - x positive (x+) mask for WUF/BTS, 0=disable, 1=enable.  
**NYWUE** - y negative (y-) mask for WUF/BTS, 0=disable, 1=enable.  
**PYWUE** - y positive (y+) mask for WUF/BTS, 0=disable, 1=enable.  
**NZWUE** - z negative (z-) mask for WUF/BTS, 0=disable, 1=enable.  
**PZWUE** - z positive (z+) mask for WUF/BTS, 0=disable, 1=enable.

**FSYNC\_CTL**

External Synchronous control register.

|               |          |             |             |          |            |            |            |             |
|---------------|----------|-------------|-------------|----------|------------|------------|------------|-------------|
| R/W           | R/W      | R/W         | R/W         | R/W      | R/W        | R/W        | R/W        |             |
| Reserved      | Reserved | FSYNC_MODE1 | FSYNC_MODE2 | Reserved | FSYNC_SEL2 | FSYNC_SEL1 | FSYNC_SEL0 | Reset Value |
| Bit7          | Bit6     | Bit5        | Bit4        | Bit3     | Bit2       | Bit1       | Bit0       | 00000000    |
| Address: 0x4A |          |             |             |          |            |            |            |             |

**FSYNC\_MODE[1:0]:** FSYNC enable and mode select.  
2'b00: FSYNC is disabled. SYNC pin is tri-stated.  
2'b01: FSYNC is enabled. Sync pin is configured as input pin.  
Buffer is updated in sync with external clock applied at SYNC pin.  
2'b10: FSYNC is enabled. Sync pin is configured as input pin.  
State of SYNC pin is stored in selected sensor's LSB bit.  
2'b11: FSYNC is disabled. SYNC pin is configured as output pin.

**FSYNC\_SEL[2:0]:** FSYNC sensor select bits.  
if(fsyc\_mode=2'b10)  
3'b000: SYNC function disabled.



## Digital Tri-axis Gyroscope/ Tri-axis Accelerometer Specifications

PART NUMBER

KXG03-1034

Rev. 2.0

14-Feb-17

3'b001: State of SYNC pin is stored in gyroscope's x LSB bit.  
 3'b010: State of SYNC pin is stored in gyroscope's y LSB bit.  
 3'b011: State of SYNC pin is stored in gyroscope's z LSB bit  
 3'b100: State of SYNC pin is stored in accelerometer's x LSB bit.  
 3'b101: State of SYNC pin is stored in accelerometer's y LSB bit.  
 3'b110: State of SYNC pin is stored in accelerometer's z LSB bit.  
 3'b111: State of SYNC pin is stored in temperature LSB bit  
 if(fsync\_mode=2'b11)  
 3'b000: SYNC pin outputs gyroscope ODR clock.  
 3'b001: SYNC pin outputs accelerometer's ODR clock.  
 3'b010: SYNC pin outputs aux1 ODR clock.  
 3'b011: SYNC pin outputs aux2 ODR clock.  
 3'b1xx: SYNC pin disabled.

### WAKE\_SLEEP\_CTL1

Wake and Sleep control register 1.

| R/W           | R/W    | R/W       | R/W      | R/W      | R/W   | R/W   | R/W   | Reset Value |
|---------------|--------|-----------|----------|----------|-------|-------|-------|-------------|
| BTS_EN        | WUF_EN | MAN_SLEEP | MAN_WAKE | Reserved | OWUF2 | OWUF1 | OWUF0 | 00000000    |
| Bit7          | Bit6   | Bit5      | Bit4     | Bit3     | Bit2  | Bit1  | Bit0  |             |
| Address: 0x4B |        |           |          |          |       |       |       |             |

**BTS\_EN** - Active high back-to-sleep function enable.

0: Back-to-sleep transition for all sensors is not controlled by BTS function.

1: Back-to-sleep transition for all sensors is controlled by BTS function.

**WUF\_EN** - Active high wake-up function enable.

0: Sleep-to-wake transition for all sensors is not controlled by BTS function.

1: Sleep-to-wake transition for all sensors is controlled by BTS function.

**MAN\_SLEEP** - Active high manual sleep trigger.

0: No impact.

1: Forces transition to sleep state.

Please note:

Man\_sleep is a self-clearing bit. The bit is cleared automatically after transition to sleep state.

Forcing a manual sleep state does not trigger WUFS or BTS interrupts.

Setting both man\_sleep=1 and man\_wake=1 is ignored.

**MAN\_WAKE** - Active high manual wake trigger.

0: No impact.

1: Forces transition to wake state.

|   |  |                    |
|---|--|--------------------|
|  | <b>Digital Tri-axis Gyroscope/ Tri-axis Accelerometer Specifications</b> | <b>PART NUMBER</b> |
|   |  | KXG03-1034         |
|   |  | Rev. 2.0           |
|   |  | 14-Feb-17          |

*Please note:*

*Man\_sleep is a self-clearing bit. The bit is cleared automatically after transition to sleep state.*

*Forcing a manual sleep state does not trigger WUFS or BTS interrupts.*

*Setting both man\_sleep=1 and man\_wake=1 is ignored.*

**OWUF[2:0]:** sets the Output Data Rate for the Wake-up (motion detection).

| [2] | [1] | [0] | Output Data Rate (Hz) |
|-----|-----|-----|-----------------------|
| 0   | 0   | 0   | 0.781                 |
| 0   | 0   | 1   | 1.563                 |
| 0   | 1   | 0   | 3.125                 |
| 0   | 1   | 1   | 6.25                  |
| 1   | 0   | 0   | 12.5                  |
| 1   | 0   | 1   | 25                    |
| 1   | 1   | 0   | 50                    |
| 1   | 1   | 1   | 100                   |

### WAKE\_SLEEP\_CTL2

Wake and Sleep control register 1.

| R/W           | R/W      | R/W      | R/W      | R/W      | R/W      | R/W     | R/W    | Reset Value |
|---------------|----------|----------|----------|----------|----------|---------|--------|-------------|
| Reserved      | Reserved | Reserved | Reserved | Reserved | Reserved | TH_MODE | C_MODE | 00000010    |
| Bit7          | Bit6     | Bit5     | Bit4     | Bit3     | Bit2     | Bit1    | Bit0   |             |
| Address: 0x4C |          |          |          |          |          |         |        |             |

**TH\_MODE** - Defines WUF and BTS threshold mode.

*0: Absolute threshold. KXG03 compares current output to threshold.*

*1: Relative threshold. KXG03 compares difference between current output and previous output to threshold.*

**C\_MODE** - Defines de-bounce counter clear mode.

*0: Counter is cleared once activity level is outside the threshold.*

*1: Counter is decremented by one when activity level is outside the threshold.*

### WUF\_TH

This register sets the Active Threshold for wake-up (motion detect) interrupt. The KXG03 will ship from the factory with this value set to correspond to a change in acceleration of 0.5g.

Resolution = 62.5 mg/LSB for FS < ± 16 g.

Resolution = 125 mg/LSB for FS = ± 16 g.



# Digital Tri-axis Gyroscope/ Tri-axis Accelerometer Specifications

**PART NUMBER**

**KXG03-1034**

**Rev. 2.0**

**14-Feb-17**

| R/W           | R/W   | R/W   | R/W   | R/W   | R/W   | R/W   | R/W   | Reset Value |
|---------------|-------|-------|-------|-------|-------|-------|-------|-------------|
| ATH_7         | ATH_6 | ATH_5 | ATH_4 | ATH_3 | ATH_2 | ATH_1 | ATH_0 | 00001000    |
| Bit7          | Bit6  | Bit5  | Bit4  | Bit3  | Bit2  | Bit1  | Bit0  |             |
| Address: 0x4D |       |       |       |       |       |       |       |             |

## WUF\_COUNTER

This register sets the time motion must be present before a wake-up interrupt is set. Every count is calculated as 1/OWUF delay period. OWUF is set in WAKE\_SLEEP\_CTL1.

Note: Setting the register to 0xFF disables the WUF\_COUNTER.

| R/W           | R/W   | R/W   | R/W   | R/W   | R/W   | R/W   | R/W   | Reset Value |
|---------------|-------|-------|-------|-------|-------|-------|-------|-------------|
| WUFC7         | WUFC6 | WUFC5 | WUFC4 | WUFC3 | WUFC2 | WUFC1 | WUFC0 | 00000000    |
| Bit7          | Bit6  | Bit5  | Bit4  | Bit3  | Bit2  | Bit1  | Bit0  |             |
| Address: 0x4E |       |       |       |       |       |       |       |             |

## BTS\_TH

This register sets the threshold for Back-to-sleep (motion detect) interrupt. The KXG03 will ship from the factory with this value set to correspond to a change in acceleration of 0.5g.

Resolution = 62.5 mg/LSB for FS < ± 16 g.

Resolution = 125 mg/LSB for FS = ± 16 g.

| R/W           | R/W   | R/W   | R/W   | R/W   | R/W   | R/W   | R/W   | Reset Value |
|---------------|-------|-------|-------|-------|-------|-------|-------|-------------|
| BTH_7         | BTH_6 | BTH_5 | BTH_4 | BTH_3 | BTH_2 | BTH_1 | BTH_0 | 00001000    |
| Bit7          | Bit6  | Bit5  | Bit4  | Bit3  | Bit2  | Bit1  | Bit0  |             |
| Address: 0x4F |       |       |       |       |       |       |       |             |

## BTS\_COUNTER

This register sets the time motion must be present before a Back-to-sleep interrupt is set. Every count is calculated as 16/OWUF delay period. OWUF is set in WAKE\_SLEEP\_CTL1.

Note: Setting the register to 0xFF disables the BTS\_COUNTER.

| R/W           | R/W   | R/W   | R/W   | R/W   | R/W   | R/W   | R/W   | Reset Value |
|---------------|-------|-------|-------|-------|-------|-------|-------|-------------|
| BTSC7         | BTSC6 | BTSC5 | BTSC4 | BTSC3 | BTSC2 | BTSC1 | BTSC0 | 00000000    |
| Bit7          | Bit6  | Bit5  | Bit4  | Bit3  | Bit2  | Bit1  | Bit0  |             |
| Address: 0x50 |       |       |       |       |       |       |       |             |



|   |  |                    |
|---|--|--------------------|
|  | <b>Digital Tri-axis Gyroscope/ Tri-axis Accelerometer Specifications</b> | <b>PART NUMBER</b> |
|   |  | KXG03-1034         |
|   |  | Rev. 2.0           |
|   |  | 14-Feb-17          |

**AUX\_I2C\_CTL\_REG**  
Read/Write control register.

| R/W           | R/W      | R/W          | R/W          | R/W         | R/W         | R/W        | R/W      | Reset Value |
|---------------|----------|--------------|--------------|-------------|-------------|------------|----------|-------------|
| Reserved      | Reserved | AUX_CTL_POL2 | AUX_CTL_POL1 | AUX_BUS_SPD | AUX_PULL_UP | AUX_BYPASS | Reserved | 00000010    |
| Bit7          | Bit6     | Bit5         | Bit4         | Bit3        | Bit2        | Bit1       | Bit0     |             |
| Address: 0x51 |          |              |              |             |             |            |          |             |

**AUX\_CTL\_POL2** - Defines control bit polarity for aux2 enable/disable command sequences.  
0: KXG03 clears selected control bits when enabling auxiliary-2 sensor and KXG03 sets to 1 selected control bits when disabling aux2 sensor.  
1: KXG03 sets to 1 selected control bits when enabling auxiliary-2 sensor and KXG03 clears selected control bits when disabling aux2 sensor.

**AUX\_CTL\_POL1** - Defines control bit polarity for aux1 enable/disable command sequences.  
0: KXG03 clears selected control bits when enabling auxiliary-1 sensor and KXG03 sets to 1 selected control bits when disabling aux1 sensor.  
1: KXG03 sets to 1 selected control bits when enabling auxiliary-1 sensor and KXG03 clears selected control bits when disabling aux1 sensor.

**AUX\_BUS\_SPD**- Sets I2C bus speed.  
0: 100 kHz,  
1: 400 kHz

**AUX\_PULL\_UP** - Active high pull up enable.  
0: Pull up disabled.  
1: 1.5KΩ pull up resistor enabled.  
Please note the pull up resistor is automatically disabled when aux\_bypass=1 even though aux\_pull\_up may be set to 1.

**AUX\_BYPASS** – Active high bypass enable  
0: Aux I2C not bypassed  
1: Aux I2C pins shorted to main (slave) I2C pins. Pull up disabled



# Digital Tri-axis Gyroscope/ Tri-axis Accelerometer Specifications

**PART NUMBER**

**KXG03-1034**

**Rev. 2.0**

**14-Feb-17**

## AUX\_I2C\_SAD1

Read/Write that should be used to store the SAD for auxiliary I<sup>2</sup>C device 1.

| R/W           | R/W    | R/W    | R/W    | R/W    | R/W    | R/W    | R/W  |             |
|---------------|--------|--------|--------|--------|--------|--------|------|-------------|
| SAD1_6        | SAD1_5 | SAD1_4 | SAD1_3 | SAD1_2 | SAD1_1 | SAD1_0 | -    | Reset Value |
| Bit7          | Bit6   | Bit5   | Bit4   | Bit3   | Bit2   | Bit1   | Bit0 | 00000000    |
| Address: 0x52 |        |        |        |        |        |        |      |             |

## AUX\_I2C\_REG1

Read/Write that should be used to store the starting data register address for auxiliary I<sup>2</sup>C device 1.

| R/W           | R/W    | R/W    | R/W    | R/W    | R/W    | R/W    | R/W    |             |
|---------------|--------|--------|--------|--------|--------|--------|--------|-------------|
| REG1_7        | REG1_6 | REG1_5 | REG1_4 | REG1_3 | REG1_2 | REG1_1 | REG1_0 | Reset Value |
| Bit7          | Bit6   | Bit5   | Bit4   | Bit3   | Bit2   | Bit1   | Bit0   | 00000000    |
| Address: 0x53 |        |        |        |        |        |        |        |             |

## AUX\_I2C\_CTL1

Register address for enable/disable control register for auxiliary I<sup>2</sup>C device 1.

| R/W           | R/W     | R/W     | R/W     | R/W     | R/W     | R/W     | R/W     |             |
|---------------|---------|---------|---------|---------|---------|---------|---------|-------------|
| CNTL1_7       | CNTL1_6 | CNTL1_5 | CNTL1_4 | CNTL1_3 | CNTL1_2 | CNTL1_1 | CNTL1_0 | Reset Value |
| Bit7          | Bit6    | Bit5    | Bit4    | Bit3    | Bit2    | Bit1    | Bit0    | 00000000    |
| Address: 0x54 |         |         |         |         |         |         |         |             |

## AUX\_I2C\_BIT1

Defines bits to toggle in the control register for auxiliary I<sup>2</sup>C device 1.

| R/W           | R/W    | R/W    | R/W    | R/W    | R/W    | R/W    | R/W    |             |
|---------------|--------|--------|--------|--------|--------|--------|--------|-------------|
| BIT1_7        | BIT1_6 | BIT1_5 | BIT1_4 | BIT1_3 | BIT1_2 | BIT1_1 | BIT1_0 | Reset Value |
| Bit7          | Bit6   | Bit5   | Bit4   | Bit3   | Bit2   | Bit1   | Bit0   | 00000000    |
| Address: 0x55 |        |        |        |        |        |        |        |             |



# Digital Tri-axis Gyroscope/ Tri-axis Accelerometer Specifications

**PART NUMBER**

**KXG03-1034**

**Rev. 2.0**

**14-Feb-17**

## AUX\_I2C\_ODR1\_W

Defines register read controls for auxiliary I<sup>2</sup>C device 1.

| R/W           | R/W     | R/W     | R/W     | R/W       | R/W       | R/W       | R/W       | Reset Value |
|---------------|---------|---------|---------|-----------|-----------|-----------|-----------|-------------|
| Reserved      | AUX1_D2 | AUX1_D1 | AUX1_D0 | AUX1ODRW3 | AUX1ODRW2 | AUX1ODRW1 | AUX1ODRW0 | 00000110    |
| Bit7          | Bit6    | Bit5    | Bit4    | Bit3      | Bit2      | Bit1      | Bit0      |             |
| Address: 0x56 |         |         |         |           |           |           |           |             |

**AUX1\_D[2:0]:** Number of bytes read back via Auxiliary I<sup>2</sup>C bus from device 1

| [2] | [1] | [0] | No. of |
|-----|-----|-----|--------|
| 0   | 0   | 0   | 0      |
| 0   | 0   | 1   | 1      |
| 0   | 1   | 0   | 2      |
| 0   | 1   | 1   | 3      |
| 1   | 0   | 0   | 4      |
| 1   | 0   | 1   | 5      |
| 1   | 1   | 0   | 6      |
| 1   | 1   | 1   | DNE    |

**AUX1ODRW[3:0]:** Determines rate at which aux1 output is polled by KXG03 in aux1 wake state

| [3] | [2] | [1] | [0] | Output Data Rate |
|-----|-----|-----|-----|------------------|
| 0   | 0   | 0   | 0   | 0.781Hz          |
| 0   | 0   | 0   | 1   | 1.563Hz          |
| 0   | 0   | 1   | 0   | 3.125Hz          |
| 0   | 0   | 1   | 1   | 6.25Hz           |
| 0   | 1   | 0   | 0   | 12.5Hz           |
| 0   | 1   | 0   | 1   | 25Hz             |
| 0   | 1   | 1   | 0   | 50Hz             |
| 0   | 1   | 1   | 1   | 100Hz            |
| 1   | 0   | 0   | 0   | 200Hz            |
| 1   | 0   | 0   | 1   | 400Hz            |
| 1   | 0   | 1   | 0   | 800Hz            |
| 1   | 0   | 1   | 1   | 1600Hz           |
| 1   | 1   | 0   | 0   | 1600Hz           |
| 1   | 1   | 0   | 1   | 1600Hz           |
| 1   | 1   | 1   | 0   | 1600Hz           |
| 1   | 1   | 1   | 1   | 1600Hz           |

|   |  |                    |
|---|--|--------------------|
|  | <b>Digital Tri-axis Gyroscope/ Tri-axis Accelerometer Specifications</b> | <b>PART NUMBER</b> |
|   |  | KXG03-1034         |
|   |  | Rev. 2.0           |
|   |  | 14-Feb-17          |

**AUX\_I2C\_ODR1\_S**

Defines register read controls for auxiliary I<sup>2</sup>C device 1.

|               |          |          |          |           |           |           |           |             |
|---------------|----------|----------|----------|-----------|-----------|-----------|-----------|-------------|
| R/W           | R/W      | R/W      | R/W      | R/W       | R/W       | R/W       | R/W       | Reset Value |
| Reserved      | Reserved | Reserved | Reserved | AUX1ODRS3 | AUX1ODRS2 | AUX1ODRS1 | AUX1ODRS0 | 00000110    |
| Bit7          | Bit6     | Bit5     | Bit4     | Bit3      | Bit2      | Bit1      | Bit0      |             |
| Address: 0x57 |          |          |          |           |           |           |           |             |

**AUX1ODRS[3:0]:** Determines rate at which aux1 output is polled by KXG03 in aux1 sleep state

| [3] | [2] | [1] | [0] | Output Data Rate |
|-----|-----|-----|-----|------------------|
| 0   | 0   | 0   | 0   | 0.781Hz          |
| 0   | 0   | 0   | 1   | 1.563Hz          |
| 0   | 0   | 1   | 0   | 3.125Hz          |
| 0   | 0   | 1   | 1   | 6.25Hz           |
| 0   | 1   | 0   | 0   | 12.5Hz           |
| 0   | 1   | 0   | 1   | 25Hz             |
| 0   | 1   | 1   | 0   | 50Hz             |
| 0   | 1   | 1   | 1   | 100Hz            |
| 1   | 0   | 0   | 0   | 200Hz            |
| 1   | 0   | 0   | 1   | 400Hz            |
| 1   | 0   | 1   | 0   | 800Hz            |
| 1   | 0   | 1   | 1   | 1600Hz           |
| 1   | 1   | 0   | 0   | 1600Hz           |
| 1   | 1   | 0   | 1   | 1600Hz           |
| 1   | 1   | 1   | 0   | 1600Hz           |
| 1   | 1   | 1   | 1   | 1600Hz           |

**AUX\_I2C\_SAD2**

Read/Write that should be used to store the SAD for auxiliary I<sup>2</sup>C device 2.

|               |        |        |        |        |        |        |      |             |
|---------------|--------|--------|--------|--------|--------|--------|------|-------------|
| R/W           | R/W    | R/W    | R/W    | R/W    | R/W    | R/W    | R/W  | Reset Value |
| SAD2_6        | SAD2_5 | SAD2_4 | SAD2_3 | SAD2_2 | SAD2_1 | SAD2_0 | -    | 00000000    |
| Bit7          | Bit6   | Bit5   | Bit4   | Bit3   | Bit2   | Bit1   | Bit0 |             |
| Address: 0x58 |        |        |        |        |        |        |      |             |



# Digital Tri-axis Gyroscope/ Tri-axis Accelerometer Specifications

**PART NUMBER**

**KXG03-1034**

**Rev. 2.0**

**14-Feb-17**

## AUX\_I2C\_REG2

Read/Write that should be used to store the starting data register address for auxiliary I<sup>2</sup>C device 2.

| R/W           | R/W    | R/W    | R/W    | R/W    | R/W    | R/W    | R/W    | Reset Value |
|---------------|--------|--------|--------|--------|--------|--------|--------|-------------|
| REG2_7        | REG2_6 | REG2_5 | REG2_4 | REG2_3 | REG2_2 | REG2_1 | REG2_0 | 00000000    |
| Bit7          | Bit6   | Bit5   | Bit4   | Bit3   | Bit2   | Bit1   | Bit0   |             |
| Address: 0x59 |        |        |        |        |        |        |        |             |

## AUX\_I2C\_CTL2

Register address for enable/disable control register for auxiliary I<sup>2</sup>C device 2.

| R/W           | R/W     | R/W     | R/W     | R/W     | R/W     | R/W     | R/W     | Reset Value |
|---------------|---------|---------|---------|---------|---------|---------|---------|-------------|
| CNTL2_7       | CNTL2_6 | CNTL2_5 | CNTL2_4 | CNTL2_3 | CNTL2_2 | CNTL2_1 | CNTL2_0 | 00000000    |
| Bit7          | Bit6    | Bit5    | Bit4    | Bit3    | Bit2    | Bit1    | Bit0    |             |
| Address: 0x5A |         |         |         |         |         |         |         |             |

## AUX\_I2C\_BIT2

Defines bits to toggle in the control register for auxiliary I<sup>2</sup>C device 2.

| R/W           | R/W    | R/W    | R/W    | R/W    | R/W    | R/W    | R/W    | Reset Value |
|---------------|--------|--------|--------|--------|--------|--------|--------|-------------|
| BIT2_7        | BIT2_6 | BIT2_5 | BIT2_4 | BIT2_3 | BIT2_2 | BIT2_1 | BIT2_0 | 00000000    |
| Bit7          | Bit6   | Bit5   | Bit4   | Bit3   | Bit2   | Bit1   | Bit0   |             |
| Address: 0x5B |        |        |        |        |        |        |        |             |

## AUX\_I2C\_ODR2\_W

Defines register read controls for auxiliary I<sup>2</sup>C device 2.

| R/W           | R/W     | R/W     | R/W     | R/W       | R/W       | R/W       | R/W       | Reset Value |
|---------------|---------|---------|---------|-----------|-----------|-----------|-----------|-------------|
| Reserved      | AUX2_D2 | AUX2_D1 | AUX2_D0 | AUX2ODRW3 | AUX2ODRW2 | AUX2ODRW1 | AUX2ODRW0 | 00000110    |
| Bit7          | Bit6    | Bit5    | Bit4    | Bit3      | Bit2      | Bit1      | Bit0      |             |
| Address: 0x5C |         |         |         |           |           |           |           |             |



## Digital Tri-axis Gyroscope/ Tri-axis Accelerometer Specifications

PART NUMBER

KXG03-1034

Rev. 2.0

14-Feb-17

**AUX2\_D[2:0]:** Number of bytes read back via Auxiliary I<sup>2</sup>C bus from device 2

| [2] | [1] | [0] | No. of Bytes |
|-----|-----|-----|--------------|
| 0   | 0   | 0   | 0            |
| 0   | 0   | 1   | 1            |
| 0   | 1   | 0   | 2            |
| 0   | 1   | 1   | 3            |
| 1   | 0   | 0   | 4            |
| 1   | 0   | 1   | 5            |
| 1   | 1   | 0   | 6            |
| 1   | 1   | 1   | DNE          |

**AUX2ODRW[3:0]:** Determines rate at which aux2 output is polled by KXG03 in aux2 wake state

| [3] | [2] | [1] | [0] | Output Data Rate |
|-----|-----|-----|-----|------------------|
| 0   | 0   | 0   | 0   | 0.781Hz          |
| 0   | 0   | 0   | 1   | 1.563Hz          |
| 0   | 0   | 1   | 0   | 3.125Hz          |
| 0   | 0   | 1   | 1   | 6.25Hz           |
| 0   | 1   | 0   | 0   | 12.5Hz           |
| 0   | 1   | 0   | 1   | 25Hz             |
| 0   | 1   | 1   | 0   | 50Hz             |
| 0   | 1   | 1   | 1   | 100Hz            |
| 1   | 0   | 0   | 0   | 200Hz            |
| 1   | 0   | 0   | 1   | 400Hz            |
| 1   | 0   | 1   | 0   | 800Hz            |
| 1   | 0   | 1   | 1   | 1600Hz           |
| 1   | 1   | 0   | 0   | 1600Hz           |
| 1   | 1   | 0   | 1   | 1600Hz           |
| 1   | 1   | 1   | 0   | 1600Hz           |
| 1   | 1   | 1   | 1   | 1600Hz           |

|   |  |                    |
|---|--|--------------------|
|  | <b>Digital Tri-axis Gyroscope/ Tri-axis Accelerometer Specifications</b> | <b>PART NUMBER</b> |
|   |  | KXG03-1034         |
|   |  | Rev. 2.0           |
|   |  | 14-Feb-17          |

**AUX\_I2C\_ODR2\_S**

Defines register read controls for auxiliary I<sup>2</sup>C device 2.

|               |          |          |          |           |           |           |           |             |
|---------------|----------|----------|----------|-----------|-----------|-----------|-----------|-------------|
| R/W           | R/W      | R/W      | R/W      | R/W       | R/W       | R/W       | R/W       | Reset Value |
| Reserved      | Reserved | Reserved | Reserved | AUX2ODRS3 | AUX2ODRS2 | AUX2ODRS1 | AUX2ODRS0 | 00000110    |
| Bit7          | Bit6     | Bit5     | Bit4     | Bit3      | Bit2      | Bit1      | Bit0      |             |
| Address: 0x5D |          |          |          |           |           |           |           |             |

**AUX2ODRS[3:0]:** Determines rate at which aux2 output is polled by KXG03 in aux2 sleep state

| [3] | [2] | [1] | [0] | Output Data Rate |
|-----|-----|-----|-----|------------------|
| 0   | 0   | 0   | 0   | 0.781Hz          |
| 0   | 0   | 0   | 1   | 1.563Hz          |
| 0   | 0   | 1   | 0   | 3.125Hz          |
| 0   | 0   | 1   | 1   | 6.25Hz           |
| 0   | 1   | 0   | 0   | 12.5Hz           |
| 0   | 1   | 0   | 1   | 25Hz             |
| 0   | 1   | 1   | 0   | 50Hz             |
| 0   | 1   | 1   | 1   | 100Hz            |
| 1   | 0   | 0   | 0   | 200Hz            |
| 1   | 0   | 0   | 1   | 400Hz            |
| 1   | 0   | 1   | 0   | 800Hz            |
| 1   | 0   | 1   | 1   | 1600Hz           |
| 1   | 1   | 0   | 0   | 1600Hz           |
| 1   | 1   | 0   | 1   | 1600Hz           |
| 1   | 1   | 1   | 0   | 1600Hz           |
| 1   | 1   | 1   | 1   | 1600Hz           |

**BUF\_WMITH\_L**

Read/write control register that controls the buffer sample threshold.

|               |         |          |          |          |          |          |          |             |
|---------------|---------|----------|----------|----------|----------|----------|----------|-------------|
| R/W           | R/W     | R/W      | R/W      | R/W      | R/W      | R/W      | R/W      | Reset Value |
| SMP_TH1       | SMP_TH0 | Reserved | Reserved | Reserved | Reserved | Reserved | Reserved | 00000000    |
| Bit7          | Bit6    | Bit5     | Bit4     | Bit3     | Bit2     | Bit1     | Bit0     |             |
| Address: 0x75 |         |          |          |          |          |          |          |             |

|   |  |                    |
|---|--|--------------------|
|  | <b>Digital Tri-axis Gyroscope/ Tri-axis Accelerometer Specifications</b> | <b>PART NUMBER</b> |
|   |  | <b>KXG03-1034</b>  |
|   |  | <b>Rev. 2.0</b>    |
|   |  | <b>14-Feb-17</b>   |

**BUF\_WMITH\_H**

Read/write control register that controls the buffer sample threshold.

|               |         |         |         |         |         |         |         |             |
|---------------|---------|---------|---------|---------|---------|---------|---------|-------------|
| R/W           | R/W     | R/W     | R/W     | R/W     | R/W     | R/W     | R/W     |             |
| SMP_TH9       | SMP_TH8 | SMP_TH7 | SMP_TH6 | SMP_TH5 | SMP_TH4 | SMP_TH3 | SMP_TH2 | Reset Value |
| Bit7          | Bit6    | Bit5    | Bit4    | Bit3    | Bit2    | Bit1    | Bit0    | 00000000    |
| Address: 0x76 |         |         |         |         |         |         |         |             |

**SMP\_TH[9:0] Sample Threshold;** determines the number of data packets (ODR cycles) in a watermark interrupt in FIFO, Stream, FILO, or TRIGGER mode.

**BUF\_TRIGTH\_L**

Read/write control register that controls the buffer sample threshold.

|               |          |          |          |          |          |          |          |             |
|---------------|----------|----------|----------|----------|----------|----------|----------|-------------|
| R/W           | R/W      | R/W      | R/W      | R/W      | R/W      | R/W      | R/W      |             |
| TRIG_TH1      | TRIG_TH0 | Reserved | Reserved | Reserved | Reserved | Reserved | Reserved | Reset Value |
| Bit7          | Bit6     | Bit5     | Bit4     | Bit3     | Bit2     | Bit1     | Bit0     | 00000000    |
| Address: 0x77 |          |          |          |          |          |          |          |             |

**BUF\_TRIGTH\_H**

Read/write control register that controls the buffer sample threshold.

|               |          |          |          |          |          |          |          |             |
|---------------|----------|----------|----------|----------|----------|----------|----------|-------------|
| R/W           | R/W      | R/W      | R/W      | R/W      | R/W      | R/W      | R/W      |             |
| TRIG_TH9      | TRIG_TH8 | TRIG_TH7 | TRIG_TH6 | TRIG_TH5 | TRIG_TH4 | TRIG_TH3 | TRIG_TH2 | Reset Value |
| Bit7          | Bit6     | Bit5     | Bit4     | Bit3     | Bit2     | Bit1     | Bit0     | 00000000    |
| Address: 0x78 |          |          |          |          |          |          |          |             |

**TRIG\_TH[9:0] Trigger Threshold;** determines the number of data packets (ODR cycles) that will trigger an interrupt in Trigger mode.





# Digital Tri-axis Gyroscope/ Tri-axis Accelerometer Specifications

PART NUMBER

KXG03-1034

Rev. 2.0

14-Feb-17

## BUF\_CTL2

Read/write control register that controls sample buffer input in wake mode.

| R/W           | R/W        | R/W         | R/W         | R/W         | R/W         | R/W         | R/W         | Reset Value |
|---------------|------------|-------------|-------------|-------------|-------------|-------------|-------------|-------------|
| Reserved      | BUF_TEMP_W | BUF_ACC_W_X | BUF_ACC_W_Y | BUF_ACC_W_Z | BUF_GYR_W_X | BUF_GYR_W_Y | BUF_GYR_W_Z | 00000000    |
| Bit7          | Bit6       | Bit5        | Bit4        | Bit3        | Bit2        | Bit1        | Bit0        |             |
| Address: 0x79 |            |             |             |             |             |             |             |             |

**BUF\_TEMP\_W** controls the Temperature input into the sample buffer.

*BUF\_TEMP\_W = 0 – Temperature data is not input into the sample buffer*

*BUF\_TEMP\_W = 1 – Temperature data is input into the sample buffer*

**BUF\_ACC\_W[XYZ]** controls the Accelerometer axis input into the sample buffer.

*BUF\_ACC\_W = 0 – Accelerometer data is not input into the sample buffer*

*BUF\_ACC\_W = 1 – Accelerometer data is input into the sample buffer*

**BUF\_GYR\_W[XYZ]** controls the Gyroscope axis input into the sample buffer.

*BUF\_GYR\_W = 0 – Gyroscope data is not input into the sample buffer*

*BUF\_GYR\_W = 1 – Gyroscope data is input into the sample buffer*

## BUF\_CTL3

Read/write control register that controls sample buffer input in sleep mode.

| R/W           | R/W        | R/W         | R/W         | R/W         | R/W         | R/W         | R/W         | Reset Value |
|---------------|------------|-------------|-------------|-------------|-------------|-------------|-------------|-------------|
| Reserved      | BUF_TEMP_S | BUF_ACC_S_X | BUF_ACC_S_Y | BUF_ACC_S_Z | BUF_GYR_S_X | BUF_GYR_S_Y | BUF_GYR_S_Z | 00000000    |
| Bit7          | Bit6       | Bit5        | Bit4        | Bit3        | Bit2        | Bit1        | Bit0        |             |
| Address: 0x7A |            |             |             |             |             |             |             |             |

**BUF\_TEMP\_S** controls the Temperature input into the sample buffer.

*BUF\_TEMP\_S = 0 – Temperature data is not input into the sample buffer*

*BUF\_TEMP\_S = 1 – Temperature data is input into the sample buffer*

**BUF\_ACC\_S[XYZ]** controls the Accelerometer axis input into the sample buffer.

*BUF\_ACC\_S = 0 – Accelerometer data is not input into the sample buffer*

*BUF\_ACC\_S = 1 – Accelerometer data is input into the sample buffer*

**BUF\_GYR\_S[XYZ]** controls the Gyroscope axis input into the sample buffer.

*BUF\_GYR\_S = 0 – Gyroscope data is not input into the sample buffer*

*BUF\_GYR\_S = 1 – Gyroscope data is input into the sample buffer*

|   |  |                    |
|---|--|--------------------|
|  | <b>Digital Tri-axis Gyroscope/ Tri-axis Accelerometer Specifications</b> | <b>PART NUMBER</b> |
|   |  | <b>KXG03-1034</b>  |
|   |  | <b>Rev. 2.0</b>    |
|   |  | <b>14-Feb-17</b>   |

**BUF\_CTL4**

Read/write control register that controls aux1 and aux2 buffer input.

|               |          |          |          |            |            |            |            |             |
|---------------|----------|----------|----------|------------|------------|------------|------------|-------------|
| R/W           | R/W      | R/W      | R/W      | R/W        | R/W        | R/W        | R/W        | Reset Value |
| Reserved      | Reserved | Reserved | Reserved | BUF_AUX2_S | BUF_AUX1_S | BUF_AUX2_W | BUF_AUX1_W | 00000000    |
| Bit7          | Bit6     | Bit5     | Bit4     | Bit3       | Bit2       | Bit1       | Bit0       |             |
| Address: 0x7B |          |          |          |            |            |            |            |             |

**BUF\_AUX2\_S** controls the aux2 input into the sample buffer in sleep mode.

*BUF\_AUX2\_S = 0 – aux2 data is not input into the sample buffer*

*BUF\_AUX2\_S = 1 – aux2 data is input into the sample buffer*

**BUF\_AUX1\_S** controls the aux1 axis input into the sample buffer in sleep mode.

*BUF\_AUX1\_S = 0 – aux1 data is not input into the sample buffer*

*BUF\_AUX1\_S = 1 – aux1 data is input into the sample buffer*

**BUF\_AUX2\_W** controls the aux2 input into the sample buffer in wake mode.

*BUF\_AUX2\_W = 0 – aux2 data is not input into the sample buffer*

*BUF\_AUX2\_W = 1 – aux2 data is input into the sample buffer*

**BUF\_AUX1\_W** controls the aux1 axis input into the sample buffer in wake mode.

*BUF\_AUX1\_W = 0 – aux1 data is not input into the sample buffer*

*BUF\_AUX1\_W = 1 – aux1 data is input into the sample buffer*

**BUF\_EN**

Read/write control register that controls sample buffer operation.

|               |          |          |          |          |          |        |        |             |
|---------------|----------|----------|----------|----------|----------|--------|--------|-------------|
| R/W           | R/W      | R/W      | R/W      | R/W      | R/W      | R/W    | R/W    | Reset Value |
| BUFE          | Reserved | Reserved | Reserved | BUF_SYM1 | BUF_SYM0 | BUF_M1 | BUF_M0 | 00000000    |
| Bit7          | Bit6     | Bit5     | Bit4     | Bit3     | Bit2     | Bit1   | Bit0   |             |
| Address: 0x7C |          |          |          |          |          |        |        |             |

**BUFE** – controls activation of the sample buffer.

*BUFE = 0 – sample buffer inactive*

*BUFE = 1 – sample buffer active*

|   |  |  |
|---|--|--|
|  | <b>Digital Tri-axis Gyroscope/ Tri-axis Accelerometer Specifications</b> | <b>PART NUMBER</b><br><b>KXG03-1034</b><br><b>Rev. 2.0</b><br><b>14-Feb-17</b> |
|---|--|--|

**BUF\_SYM1, BUF\_SYMO** – Symbol mode select.

| BUF_SYM1 | BUF_SYMO | Description  |
|----------|----------|--|
| 0        | 0        | Symbol mode disabled. KXG03 does not insert symbols into buffer output data stream.  |
| 0        | 1        | Single symbol mode enabled. KXG03 inserts 0x8000 between complete data sets whenever wake/sleep mode changes. KXG03 replaces 0x8000 in gyroscope, accelerometer and die temp data with 0x8001 codes.   |
| 1        | 0        | Dual symbol mode enables. KXG03 inserts x8000 between complete data sets to indicate wake-to-sleep transitions, and 0x8001 to indicate sleep-to-wake transitions. Symbols are only inserted when wake/sleep state changes. KXG03 replaces 0x8000 and 0x8001 gyroscope, accelerometer, and die temperature output data codes with 0x8002. |
| 1        | 1        | Dual symbol mode for every frame. KXG03 inserts 0x8000 or 0x8001 symbols between every complete data set (frame) according to the current wake/sleep state.  |

**BUF\_M1, BUF\_M0** selects the operating mode of the sample buffer.

| BUF_M1 | BUF_M0 | Mode     | Description  |
|--------|--------|----------|--|
| 0      | 0      | FIFO*    | The buffer collects up to 1024 bytes of data plus two (2) additional data sets until full, collecting new data only when the buffer is not full.   |
| 0      | 1      | Stream   | The buffer collects up to and holds the last 1024 bytes of data plus two (2) additional data sets. Once the buffer is full, the oldest data is discarded to make room for newer data.  |
| 1      | 0      | Trigger* | When a trigger event occurs (logic high input on TRIG pin), the buffer holds the last data set of SMP[6:0] samples before the trigger event and then continues to collect data until full. New data is collected only when the buffer is not full. |
| 1      | 1      | FILO     | The buffer holds the last 1024 bytes of data plus two (2) additional data sets. Once the buffer is full, the oldest data is discarded to make room for newer data. Reading from the buffer in this mode will return the most recent data first.    |

\*Note: Data is stored as sets of bytes. If there is not enough room in the buffer to hold the new set of data (i.e. exceeds 1024-bytes + two (2) additional data sets), it will not be stored.



# Digital Tri-axis Gyroscope/ Tri-axis Accelerometer Specifications

**PART NUMBER**

**KXG03-1034**

**Rev. 2.0**

**14-Feb-17**

## BUF\_STATUS

This register reports the status of the sample buffer trigger function.

|               |      |      |      |      |      |      |      |
|---------------|------|------|------|------|------|------|------|
| R/W           | R/W  | R/W  | R/W  | R/W  | R/W  | R/W  | R/W  |
| BUF_TRIG      | 0    | 0    | 0    | 0    | 0    | 0    | 0    |
| Bit7          | Bit6 | Bit5 | Bit4 | Bit3 | Bit2 | Bit1 | Bit0 |
| Address: 0x7D |      |      |      |      |      |      |      |

*BUF\_TRIG reports the status of the buffer's trigger function if this mode has been selected. When using trigger mode, a buffer read should only be performed after a trigger event.*

## BUF\_CLEAR

Latched buffer status information and the entire sample buffer are cleared when any data is written to this register.

|               |      |      |      |      |      |      |      |
|---------------|------|------|------|------|------|------|------|
| R/W           | R/W  | R/W  | R/W  | R/W  | R/W  | R/W  | R/W  |
| X             | X    | X    | X    | X    | X    | X    | X    |
| Bit7          | Bit6 | Bit5 | Bit4 | Bit3 | Bit2 | Bit1 | Bit0 |
| Address: 0x7E |      |      |      |      |      |      |      |

## BUF\_READ

Data from the buffer should be read using a single SAD+R command. The auto-increment feature of the buffer will continue to increment the read pointer to the next data in the buffer until the specified number of bytes is read. Output data is in 2's Complement format.

|               |      |      |      |      |      |      |      |
|---------------|------|------|------|------|------|------|------|
| R             | R    | R    | R    | R    | R    | R    | R    |
| X             | X    | X    | X    | X    | X    | X    | X    |
| Bit7          | Bit6 | Bit5 | Bit4 | Bit3 | Bit2 | Bit1 | Bit0 |
| Address: 0x7F |      |      |      |      |      |      |      |

|   |  |   |
|---|--|---|
|  | <b>Digital Tri-axis Gyroscope/ Tri-axis Accelerometer Specifications</b> | <b>PART NUMBER</b><br>KXG03-1034<br>Rev. 2.0<br>14-Feb-17 |
|---|--|---|

## Sample Buffer Feature Description

The 1024-byte sample buffer feature of the KXG03 accumulates and outputs data based on how it is configured. There are 4 buffer modes available. Data is collected at the highest ODR of the specified by the corresponding Wake and Sleep mode registers. Each buffer mode accumulates data, reports data, and interacts with status indicators in a slightly different way.

### FIFO Mode

#### Data Accumulation

Sample collection stops when the buffer is full.

#### Data Reporting

Data is reported with the oldest byte of the oldest sample first (X\_L or X based on resolution).

#### Status Indicators

A watermark interrupt occurs when the number of samples in the buffer reaches the Sample Threshold. The watermark interrupt stays active until the buffer contains less than this number of samples. This can be accomplished through clearing the buffer or reading greater than SMPX.

$$\text{SMPX} = \text{SMP\_LEV}[9:0] - \text{SMP\_TH}[9:0]$$

**Equation 5:** Samples above Sample Threshold

### Stream Mode

#### Data Accumulation

Sample collection continues when the buffer is full; older data is discarded to make room for newer data.

#### Data Reporting

Data is reported with the oldest sample first (uses FIFO read pointer).

#### Status Indicators

A watermark interrupt occurs when the number of samples in the buffer reaches the Sample Threshold. The watermark interrupt stays active until the buffer contains less than this number of samples. This can be accomplished through clearing the buffer or explicitly reading greater than SMPX samples (calculated with Equation 5).

|   |  |   |
|---|--|---|
|  | <b>Digital Tri-axis Gyroscope/ Tri-axis Accelerometer Specifications</b> | <b>PART NUMBER</b><br>KXG03-1034<br>Rev. 2.0<br>14-Feb-17 |
|---|--|---|

## Trigger Mode

### Data Accumulation

When a logic high signal occurs on the TRIG pin, the trigger event is asserted and TRIG[9:0] samples prior to the event are retained. Sample collection continues until the buffer is full.

### Data Reporting

Data is reported with the oldest sample first (uses FIFO read pointer).

### Status Indicators

When a physical interrupt occurs and there are at least TRIG[9:0] samples in the buffer, BUF\_TRIG in BUF\_STATUS is asserted.

## FILO Mode

### Data Accumulation

Sample collection continues when the buffer is full; older data is discarded to make room for newer data.

### Data Reporting

Data is reported with the newest byte of the newest sample first (Z\_H or Z based on resolution).

### Status Indicators

A watermark interrupt occurs when the number of samples in the buffer reaches the Sample Threshold. The watermark interrupt stays active until the buffer contains less than this number of samples. This can be accomplished through clearing the buffer or explicitly reading greater than SMPX samples (calculated with Equation 5).

## Buffer Operation

The following diagrams illustrate the operation of the buffer conceptually. Actual physical implementation has been abstracted to offer a simplified explanation of how the different buffer modes operate. Figure 7 represents a high-resolution 3-axis sample within the buffer. Figure 8 through Figure 16 represent a 10-sample version of the buffer (for simplicity), with Sample Threshold set to 8.

Regardless of the selected mode, the buffer fills sequentially, one byte at a time. Figure 7 shows one 6-byte data sample. Note the location of the FILO read pointer versus that of the FIFO read pointer.



# Digital Tri-axis Gyroscope/ Tri-axis Accelerometer Specifications

**PART NUMBER**

**KXG03-1034**

**Rev. 2.0**

**14-Feb-17**

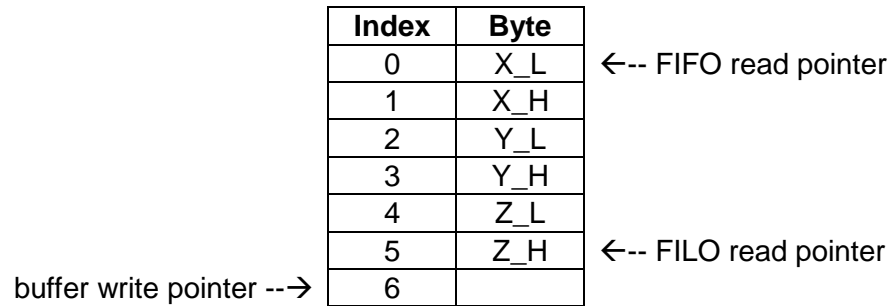

**Figure 7: One Buffer Sample**

Regardless of the selected mode, the buffer fills sequentially, one sample at a time. Note in Figure 8 the location of the FILO read pointer versus that of the FIFO read pointer. The buffer write pointer shows where the next sample will be written to the buffer.

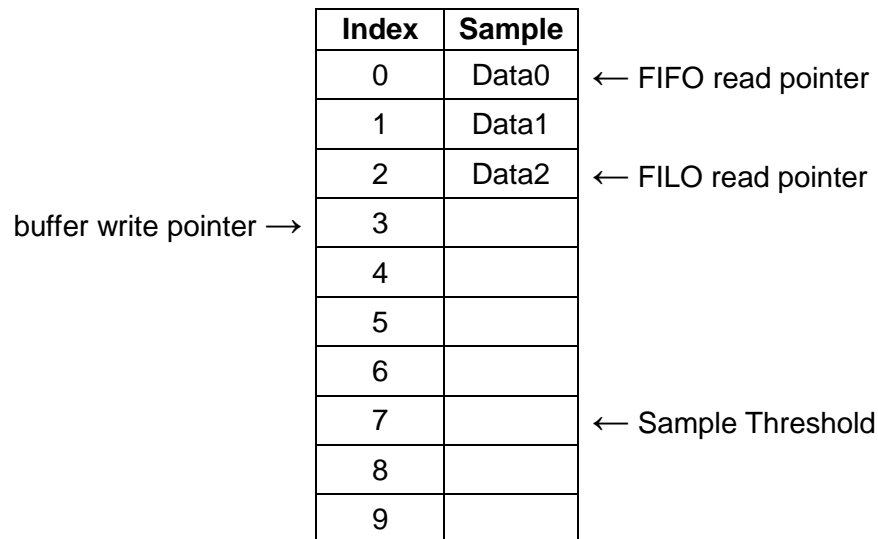

**Figure 8: Buffer Filling**



# Digital Tri-axis Gyroscope/ Tri-axis Accelerometer Specifications

**PART NUMBER**  
KXG03-1034  
Rev. 2.0  
14-Feb-17

The buffer continues to fill sequentially until the Sample Threshold is reached. Note in Figure 9 the location of the FILO read pointer versus that of the FIFO read pointer.

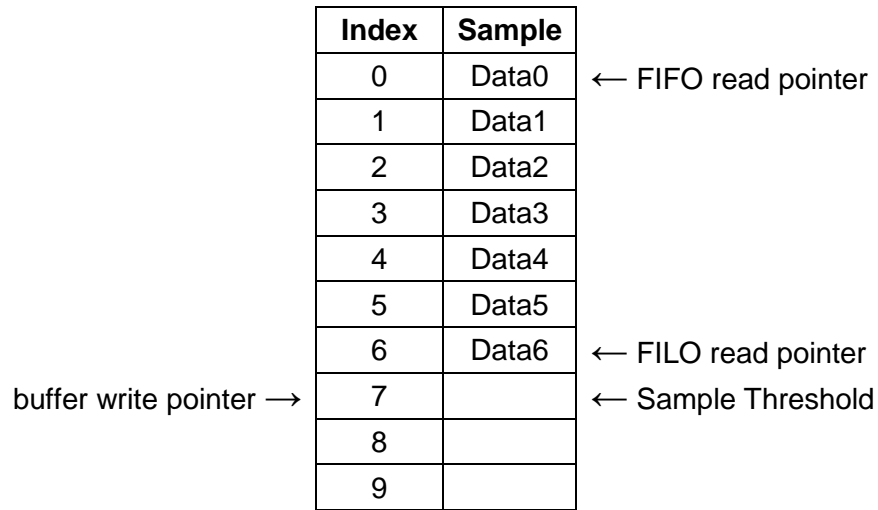

**Figure 9:** Buffer Approaching Sample Threshold

In FIFO, Stream, and FILO modes, a watermark interrupt is issued when the number of samples in the buffer reaches the Sample Threshold. In trigger mode, this is the point where the oldest data in the buffer is discarded to make room for newer data.

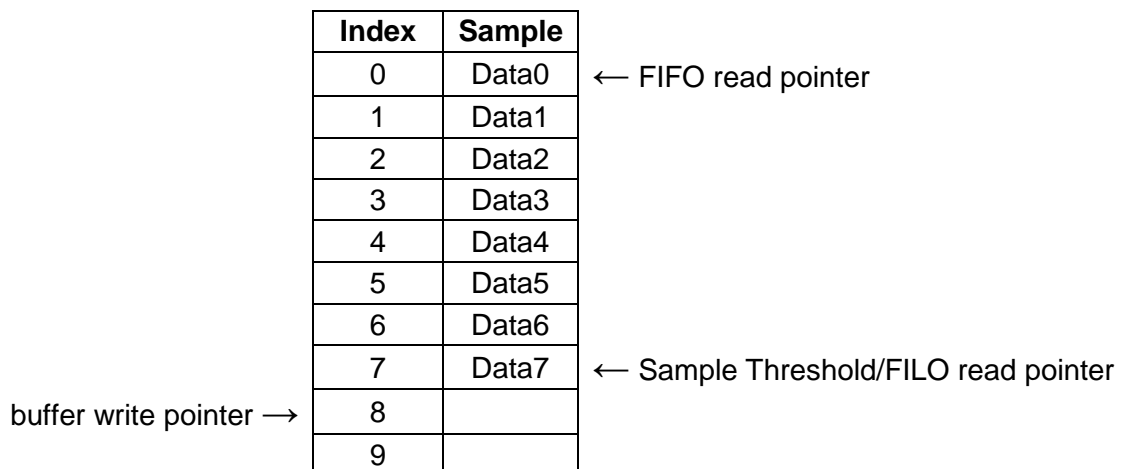

**Figure 10:** Buffer at Sample Threshold



In trigger mode, data is accumulated in the buffer sequentially until the Trigger Threshold is reached. Once the Trigger Threshold is reached, the oldest samples are discarded when new samples are collected. Note in Figure 11 how Data0 was thrown out to make room for Data8.

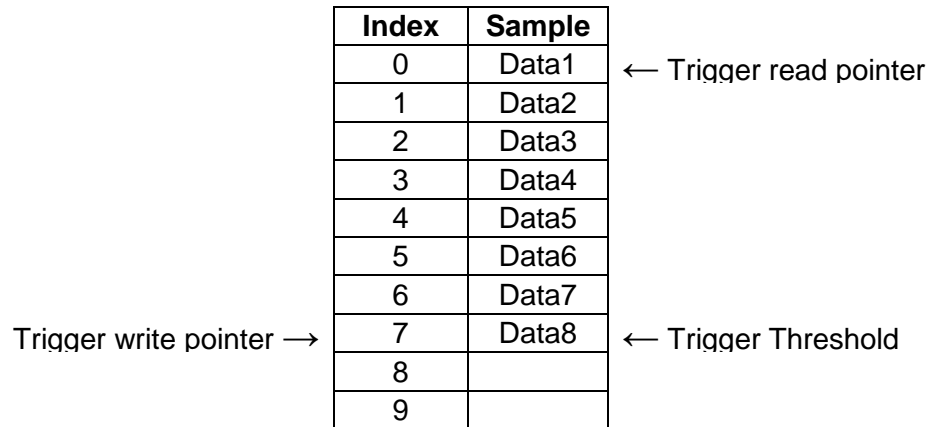

**Figure 11: Additional Data Prior to Trigger Event**

After a trigger event occurs, the buffer no longer discards the oldest samples, and instead begins accumulating samples sequentially until full. The buffer then stops collecting samples, as seen in Figure 12. This results in the buffer holding TRIG\_TH[9:0] samples prior to the trigger event, and TRIGX samples after the trigger event.

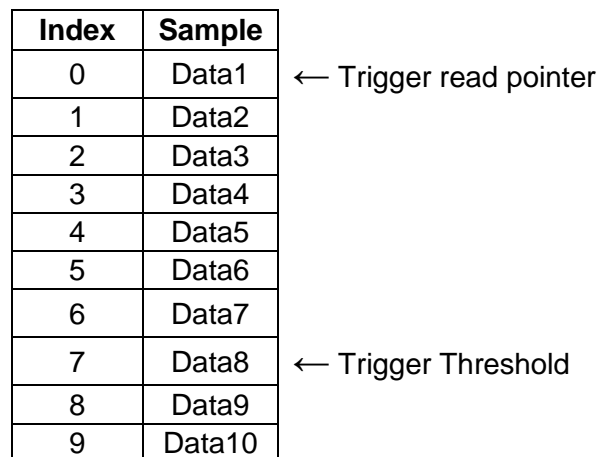

**Figure 12: Additional Data after Trigger Event**

|   |  |   |
|---|--|---|
|  | <b>Digital Tri-axis Gyroscope/ Tri-axis Accelerometer Specifications</b> | <b>PART NUMBER</b><br>KXG03-1034<br>Rev. 2.0<br>14-Feb-17 |
|---|--|---|

In FIFO, Stream, FILO, and Trigger (after a trigger event has occurred) modes, the buffer continues filling sequentially after the Sample Threshold is reached. Sample accumulation after the buffer is full depends on the selected operation mode. FIFO and Trigger modes stop accumulating samples when the buffer is full, and Stream and FILO modes begin discarding the oldest data when new samples are accumulated.

| Index | Sample |                     |
|-------|--------|---------------------|
| 0     | Data0  | ← FIFO read pointer |
| 1     | Data1  |                     |
| 2     | Data2  |                     |
| 3     | Data3  |                     |
| 4     | Data4  |                     |
| 5     | Data5  |                     |
| 6     | Data6  |                     |
| 7     | Data7  | ← Sample Threshold  |
| 8     | Data8  |                     |
| 9     | Data9  | ← FILO read pointer |

**Figure 13: Buffer Full**

After the buffer has been filled in FILO or Stream mode, the oldest samples are discarded when new samples are collected. Note in Figure 14 how Data0 was thrown out to make room for Data10.

| Index | Sample |                     |
|-------|--------|---------------------|
| 0     | Data1  | ← FIFO read pointer |
| 1     | Data2  |                     |
| 2     | Data3  |                     |
| 3     | Data4  |                     |
| 4     | Data5  |                     |
| 5     | Data6  |                     |
| 6     | Data7  |                     |
| 7     | Data8  | ← Sample Threshold  |
| 8     | Data9  |                     |
| 9     | Data10 | ← FILO read pointer |

**Figure 14: Buffer Full – Additional Sample Accumulation in Stream or FILO Mode**



# Digital Tri-axis Gyroscope/ Tri-axis Accelerometer Specifications

**PART NUMBER**  
**KXG03-1034**  
 Rev. 2.0  
 14-Feb-17

In FIFO, Stream, or Trigger mode, reading one sample from the buffer will remove the oldest sample and effectively shift the entire buffer contents up, as seen in Figure 15.

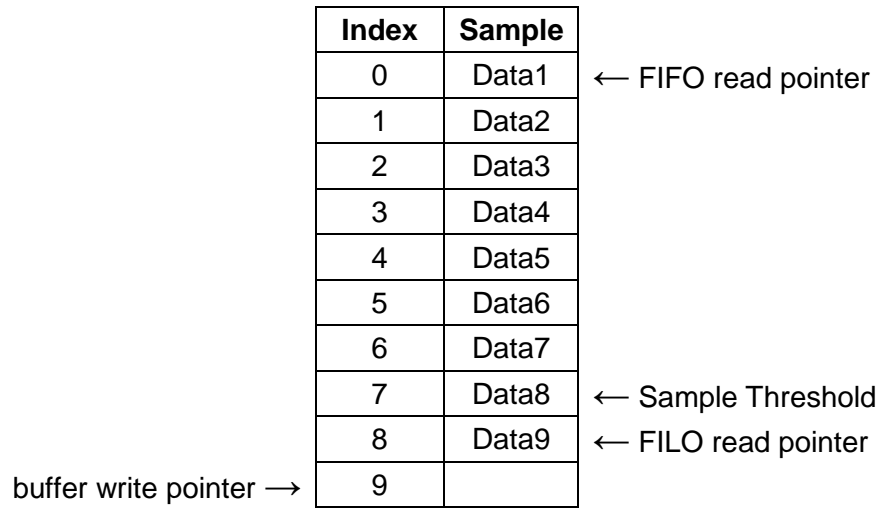

**Figure 15: FIFO Read from Full Buffer**

In FILO mode, reading one sample from the buffer will remove the newest sample and leave the older samples untouched, as seen in Figure 16.

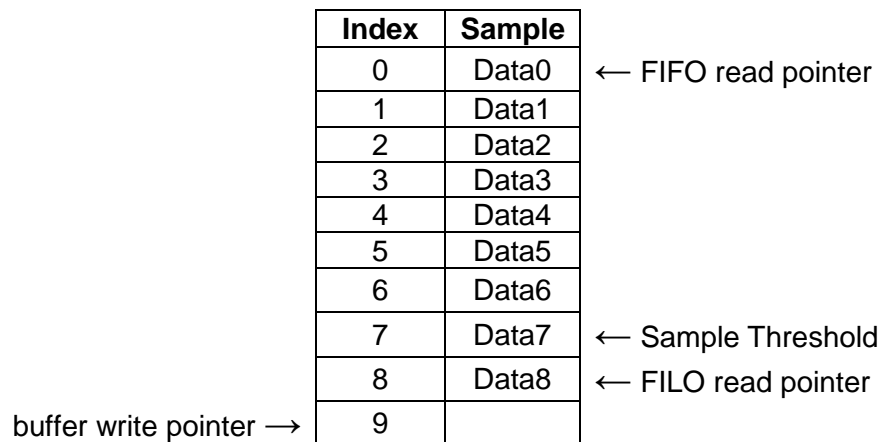

**Figure 16: FILO Read from Full Buffer**

|   |  |  |
|---|--|--|
|  | <b>Digital Tri-axis Gyroscope/ Tri-axis Accelerometer Specifications</b> | <b>PART NUMBER</b><br><b>KXG03-1034</b><br><b>Rev. 2.0</b><br><b>14-Feb-17</b> |
|---|--|--|

### Synchronizing Buffer Updates to External Clock

The buffer can be configured to update in sync with an external clock applied at the SYNC pin. Setting `FSYNC_MODE=2'b01` enables the external buffer sync feature. This forces the data in the buffer to be updated at the positive edge of the SYNC pin only. Please note even with `FSYNC_MODE=2'b01` the respective sensor output registers still update at the sensors' output data rates (ODR).

### External Interrupt Sampling

The buffer can be configured to store the state of the SYNC pin in the buffer. Setting `FSYNC_MODE=2'b10` forces the KXG03 to replace the LSB bit of the selected sensor axis with the state of SYNC pin at the time of the buffer update. This allows the user to sample the state of an external interrupt and store the interrupt value in the buffer. Please note: This function only impacts the data stored in the buffer. The sensor output registers are not impacted by this function.

### Input Data Select

The user can select which sensor's data is added to the buffer. It is possible to operate with a sensor enabled, but none of its data being stored in the buffer. In addition, for the accelerometer and gyroscope, the user can also select which axes' data is added to the buffer. There is no capability to select which auxiliary axis is added to the buffer. If auxiliary data is selected all of the corresponding sensor's data that is being read is added to the buffer.

Care needs to be taken to handle cases where a sensor's output is selected for the buffer, but the sensor is not enabled. In this case, the last available output for the selected sensor's is added to the buffer. If the output is not available, zeros (0's) are place in the buffer to that sensor's output.

### Data Order

Assuming all sensors are selected to send data to the buffer, new The data in the buffer is in the following order: gyro-x, gyro-y, gyro-z, accel-x, accel-y, accel-z, temperature, aux1, aux2. In case a sensor's output data is not selected for the buffer that sensor's slot would be skipped. Example: Assume only gyro-y, aux2 and temperature are selected for the buffer, the buffer data would then be in the following order: gyro-y, temperature, aux2.

|   |  |   |
|---|--|---|
|  | <b>Digital Tri-axis Gyroscope/ Tri-axis Accelerometer Specifications</b> | <b>PART NUMBER</b><br>KXG03-1034<br>Rev. 2.0<br>14-Feb-17 |
|---|--|---|

### Buffer Update Rate

New data is added to the buffer at the highest configured ODR rate of all the enabled sensors (STDBY). Data is added for all selected sensors (BUF\_CTL2, BUF\_CTL3, BUF\_CTL4). In the case where a selected sensor does not have new data available, it is repeated from the previous time point.

Consider the following example: Both accelerometer and gyroscope are selected to add data to the buffer and are enabled to output (STDBY). The accelerometer operates at ODR=400 Hz and the gyroscope operates at ODR=100 Hz. New data accumulates into the buffer at a 400 Hz rate. The accelerometer data is updated at the 400 Hz rate while the gyroscope data remains constant for 3 out of 4 samples.

```
gyro_d0, accel_d0
gyro_d0, accel_d1
gyro_d0, accel_d2
gyro_d0, accel_d3
gyro_d1, accel_d4
gyro_d1, accel_d5
gyro_d1, accel_d6
gyro_d1, accel_d7
gyro_d2, accel_d8
...
```

### Buffer Size Description

The buffer has a maximum size is 1024 bytes plus an additional two (2) buffers, thus expanding the overall buffer size in bytes by two (2) times the dataset in bytes ( $2 * dataset\_in\_bytes$ ).

The dataset in bytes (*dataset\_in\_bytes*) depends on what is actively being stored into the buffer. This includes which sensors are configured to store into the buffer (gyroscope, accelerometer, temperature, auxillary1, and/or auxillary2), as well as, selected axis (gyroscope and accelerometer only). The temperature sensor stores 2 bytes at a time. The data for gyroscope, accelerometer, auxillary1, and auxillary2 sensors is 6 bytes in length each. For gyroscope and accelerometer only, each axis can store 2 bytes each (if selected).

|   |  |  |
|---|--|--|
|  | <b>Digital Tri-axis Gyroscope/ Tri-axis Accelerometer Specifications</b> | <b>PART NUMBER</b><br><b>KXG03-1034</b><br><b>Rev. 2.0</b><br><b>14-Feb-17</b> |
|---|--|--|

$$\text{Maximum \# Bytes} = 1024 + 2 * ( \text{gyro\_dataset\_in\_bytes} + \text{accel\_dataset\_in\_bytes} + \text{aux1\_dataset\_in\_bytes} + \text{aux2\_dataset\_in\_bytes} + \text{temp\_dataset\_in\_bytes} )$$

$$\text{Maximum \# Bytes} = 1024 + 2 (26)$$

**Equation 6:** Maximum Number of Bytes

Example: If accelerometer (x) and gyroscope (x, y, z) are selected to be stored in the buffer, then the *dataset\_in\_bytes* is equal 8 bytes (1\*2 + 3\*6). Maximum number of bytes = 1024 + (2\*8) = 1040.

Note: To ensure the buffer is large enough, ideally declare a buffer size equal the maximum number of bytes when all sensors and axis are selected to be stored. With all sensors enabled and selected each data set contains 26 bytes (3 gyroscope axes at 2 bytes each, 3 accelerometer axes at 2 bytes each, 2 bytes for temperature, plus 6 bytes for each of the two auxiliary sensors).

The maximum number of ODR cycles the buffer can actually hold is determined by dividing the maximum buffer size (1024 bytes) by the dataset in bytes and adding two (2) samples.

$$\text{Maximum \# ODR Cycles} = \text{round-down}(1024/\text{dataset\_in\_bytes}) + 2$$

**Equation 7:** Maximum Number of ODR Cycles

The number of bytes to read from the sample buffer is determined by multiplying the number of samples (BUF\_SMPLEV) by the *dataset\_in\_bytes*. If only accelerometer (x, y and z) data is being stored to the buffer, the number of bytes to read when the buffer is full would be equal to 4104 (684 ODR cycles \* 6 bytes).

**Buffer Full Interrupt (BFI)**

The buffer features a buffer full interrupt. When enabled, the buffer full interrupt triggers when the buffer contains so much un-read data that the buffer has insufficient space for one

|   |  |  |
|---|--|--|
|  | <b>Digital Tri-axis Gyroscope/ Tri-axis Accelerometer Specifications</b> | <b>PART NUMBER</b><br><b>KXG03-1034</b><br><b>Rev. 2.0</b><br><b>14-Feb-17</b> |
|---|--|--|

additional full data set. This implies that the buffer full level is a function of which (or how much) data is selected to go into the buffer.

With all sensors enabled and selected each data set contains 26 bytes (3 accel axes at 2 bytes each, 3 gyro axes at 2 bytes each, 2 bytes for temperature, plus 6 bytes for each of the two aux sensors). In this case buffer full would be triggered when the buffer contains less than 26 bytes of free space, or when the remaining buffer space is smaller than the size of the data set.

The max size of one data set is 26 bytes as mentioned above. The minimum data packet size is 1 byte. In cases (assuming an auxiliary sensor is active in single byte mode and only the auxiliary data is stored in the buffer) in which case the buffer can hold up to 2048 data sets since the data is stored in 17-bit words.

The buffer generates a buffer full output flag, BFI, for the interrupt control logic while BUF\_EN=1. The buffer shall not generate a BFI flag while BUF\_EN=0. Latching and clearing of the BFI is handled in the interrupt control logic module.

### **SMP\_PAST Counter (Packets Lost Since BFI)**

SMP\_PAST[9:0] measures the number of data-sets or packets lost since buffer full status was reached. For FIFO and TRIGGER modes this is equal to the number of ODR cycles since the buffer full level has been reached. For STREAM mode this is equal to the number of data-sets that have been overridden by new data since the buffer filled up. The SMP\_PAST counter stops counting when the buffer output is read. SMP\_PAST[9:0] is cleared when the SMP\_PAST is read or the buffer is cleared. Care needs to be taken not to overflow SMP\_PAST[9:0].

### **Watermark (WMI)**

The buffer includes a programmable watermark. The watermark (SMP\_TH[9:0]) is measured in number of data sets in the buffer. In other words, the watermark is measured at the highest ODR rate of all the sensors selected to write in to the buffer.

The buffer generates a watermark output flag, WMI, for the interrupt control logic while BUF\_EN=1. The buffer shall not generate a WMI flag while BUF\_EN=0. Latching and clearing of the wmi is handled in the interrupt control logic module.

### **Buffer Level**

SMP\_LEV[9:0] indicates to the user how many data sets (ODR cycles) are currently stored in the buffer. Please note when operating the buffer in STREAM mode or during the STREAM

|   |  |  |
|---|--|--|
|  | <b>Digital Tri-axis Gyroscope/ Tri-axis Accelerometer Specifications</b> | <b>PART NUMBER</b><br><b>KXG03-1034</b><br><b>Rev. 2.0</b><br><b>14-Feb-17</b> |
|---|--|--|

phase of TRIGGER mode SMP\_LEV will briefly decrement by one count during a buffer full condition while the buffer discard old data for new incoming data.

### Changing Buffer Configurations

Unless otherwise noted, buffer configurations can only be changed while the buffer is disabled (BUF\_EN=0). This includes data select bits, buffer operating mode, watermark level, etc.

### Changing Sensor Configurations

Changes to the sensor configuration (ODR, Bandwidth, FS range, etc.) while the buffer is enabled are not captured in the buffer. It is strongly recommended to disable and flush the buffer when changing sensor configurations.

### Clearing the Buffer

The buffer is cleared or flushed and all counters are reset when (1) a non-zero value to the BUF\_CLEAR register or (2) the buffer transitions from disabled (BUF\_EN=0) to (BUF\_EN=1) state. Clearing the buffer takes approximately 2-3  $\mu$ sec. To avoid receiving corrupted data, the buffer contents, sample level, or packets lost for the first 10  $\mu$ sec after clearing or enabling the buffer.

### Buffer Reads

The buffer is read from register 0x7F (BUF\_READ). The buffer data shall be read using burst mode read operations (See Digital Interface section for more details). The buffer holds off writing to RAM during buffer reads of registers 0x7C-0x7F to avoid loss of data occurring during read/write collisions. The held off data is written to the RAM at the end of the burst mode read operation. This is done for all buffer modes. This requires to end the burst mode read operations within  $\frac{1}{2}$  of the ODR cycle to avoid loss of new data. For multiple sensor scenarios, “within  $\frac{1}{2}$  ODR cycle” becomes “within half the period of the highest enabled ODR cycle”. The time required to read out N number of datasets is a function of the SPI/I2C clock rate, the selected ODR and the selected dataset size. Exercise care when configuration the KXG08 to avoid loss of data during buffer reads.

**Important Note:** Single byte reads are supported. However, it is required to read out each 16-bit word (2 bytes) in less than 1 ODR cycle. Stretching out the read of a data byte to more than one ODR cycle will lead to data corruption.



|   |  |  |
|---|--|--|
|  | <b>Digital Tri-axis Gyroscope/ Tri-axis Accelerometer Specifications</b> | <b>PART NUMBER</b><br><b>KXG03-1034</b><br><b>Rev. 2.0</b><br><b>14-Feb-17</b> |
|---|--|--|

## Revision History

| REVISION | DESCRIPTION   | DATE        |
|----------|---|-------------|
| 1.0      | Initial release   | 22-Jun-2016 |
| 2.0      | Swapped order of GYRO_RUN and GYRO_START in the bit description section for STATUS1 register (0x36).<br>Changed name for AUX_I2C_CTRL_REG to AUX_I2C_CTL_REG<br>Changed the note regarding AUX_PULL_UP in AUX_I2C_CTL_REG<br>Changed the reset value of AUX_I2C_CTRL_REG to 0x02 (aux_bypass=1)<br>Added additional note to pin descriptions regarding applications not utilizing AUX_CL, AUX_DA, and updated nCS bit description.<br>Updated VDD max, Power Consumption, Noise values, and Software Reset value.<br>Increased temperature sensor tolerance to 3°C in table 3.<br>Cleared up some buffer description in regards to how fast samples are collect if running different ODRs.<br>Added buffer update rate section.<br>Updated name of BUF_SMPLEV bits to SMP_LEV, BUF_SMPPAST to SMP_PAST<br>Removed BUF_RES from Equation 5 description since this option doesn't exist.<br>Fixed High Byte bit numbering in ACCELEROMETER_XOUT, YOUT, and ZOUT<br>Deleted Notice<br>Added Appendix<br>Moved POR to Technical Note<br>Buffer size clarification in buffer registers<br>Buffer Description section updated<br>Changed RST bit in CNTL_REG1 to SRST<br>Updated I2C Serial Interface section | 14-Feb-2017 |

"Kionix" is a registered trademark of Kionix, Inc. Products described herein are protected by patents issued or pending. No license is granted by implication or otherwise under any patent or other rights of Kionix. The information contained herein is believed to be accurate and reliable but is not guaranteed. Kionix does not assume responsibility for its use or distribution. Kionix also reserves the right to change product specifications or discontinue this product at any time without prior notice. This publication supersedes and replaces all information previously supplied.

## Appendix

The following Notice is included to guide the use of Kionix products in its application and manufacturing processes. Kionix, Inc., is a ROHM Group company. For purposes of this Notice, the name "ROHM" would also imply Kionix, Inc.

# Notice

## Precaution on using ROHM Products

- Our Products are designed and manufactured for application in ordinary electronic equipments (such as AV equipment, OA equipment, telecommunication equipment, home electronic appliances, amusement equipment, etc.). If you intend to use our Products in devices requiring extremely high reliability (such as medical equipment <sup>(Note 1)</sup>, transport equipment, traffic equipment, aircraft/spacecraft, nuclear power controllers, fuel controllers, car equipment including car accessories, safety devices, etc.) and whose malfunction or failure may cause loss of human life, bodily injury or serious damage to property ("Specific Applications"), please consult with the ROHM sales representative in advance. Unless otherwise agreed in writing by ROHM in advance, ROHM shall not be in any way responsible or liable for any damages, expenses or losses incurred by you or third parties arising from the use of any ROHM's Products for Specific Applications.

(Note1) Medical Equipment Classification of the Specific Applications

| JAPAN     | USA       | EU         | CHINA     |
|-----------|-----------|------------|-----------|
| CLASS III | CLASS III | CLASS II b | CLASS III |
| CLASS IV  |           | CLASS III  |           |

- ROHM designs and manufactures its Products subject to strict quality control system. However, semiconductor products can fail or malfunction at a certain rate. Please be sure to implement, at your own responsibilities, adequate safety measures including but not limited to fail-safe design against the physical injury, damage to any property, which a failure or malfunction of our Products may cause. The following are examples of safety measures:
  - Installation of protection circuits or other protective devices to improve system safety
  - Installation of redundant circuits to reduce the impact of single or multiple circuit failure
- Our Products are designed and manufactured for use under standard conditions and not under any special or extraordinary environments or conditions, as exemplified below. Accordingly, ROHM shall not be in any way responsible or liable for any damages, expenses or losses arising from the use of any ROHM's Products under any special or extraordinary environments or conditions. If you intend to use our Products under any special or extraordinary environments or conditions (as exemplified below), your independent verification and confirmation of product performance, reliability, etc. prior to use, must be necessary:
  - Use of our Products in any types of liquid, including water, oils, chemicals, and organic solvents
  - Use of our Products outdoors or in places where the Products are exposed to direct sunlight or dust
  - Use of our Products in places where the Products are exposed to sea wind or corrosive gases, including Cl<sub>2</sub>, H<sub>2</sub>S, NH<sub>3</sub>, SO<sub>2</sub>, and NO<sub>2</sub>
  - Use of our Products in places where the Products are exposed to static electricity or electromagnetic waves
  - Use of our Products in proximity to heat-producing components, plastic cords, or other flammable items
  - Sealing or coating our Products with resin or other coating materials
  - Use of our Products without cleaning residue of flux (even if you use no-clean type fluxes, cleaning residue of flux is recommended); or Washing our Products by using water or water-soluble cleaning agents for cleaning residue after soldering
  - Use of the Products in places subject to dew condensation
- The Products are not subject to radiation-proof design.
- Please verify and confirm characteristics of the final or mounted products in using the Products.
- In particular, if a transient load (a large amount of load applied in a short period of time, such as pulse. is applied, confirmation of performance characteristics after on-board mounting is strongly recommended. Avoid applying power exceeding normal rated power; exceeding the power rating under steady-state loading condition may negatively affect product performance and reliability.
- De-rate Power Dissipation depending on ambient temperature. When used in sealed area, confirm that it is the use in the range that does not exceed the maximum junction temperature.
- Confirm that operation temperature is within the specified range described in the product specification.
- ROHM shall not be in any way responsible or liable for failure induced under deviant condition from what is defined in this document.

## Precaution for Mounting / Circuit board design

- When a highly active halogenous (chlorine, bromine, etc.) flux is used, the residue of flux may negatively affect product performance and reliability.
- In principle, the reflow soldering method must be used on a surface-mount products, the flow soldering method must be used on a through hole mount products. If the flow soldering method is preferred on a surface-mount products, please consult with the ROHM representative in advance.

For details, please refer to ROHM Mounting specification

### Precautions Regarding Application Examples and External Circuits

1. If change is made to the constant of an external circuit, please allow a sufficient margin considering variations of the characteristics of the Products and external components, including transient characteristics, as well as static characteristics.
2. You agree that application notes, reference designs, and associated data and information contained in this document are presented only as guidance for Products use. Therefore, in case you use such information, you are solely responsible for it and you must exercise your own independent verification and judgment in the use of such information contained in this document. ROHM shall not be in any way responsible or liable for any damages, expenses or losses incurred by you or third parties arising from the use of such information.

### Precaution for Electrostatic

This Product is electrostatic sensitive product, which may be damaged due to electrostatic discharge. Please take proper caution in your manufacturing process and storage so that voltage exceeding the Products maximum rating will not be applied to Products. Please take special care under dry condition (e.g. Grounding of human body / equipment / solder iron, isolation from charged objects, setting of Ionizer, friction prevention and temperature / humidity control).

### Precaution for Storage / Transportation

1. Product performance and soldered connections may deteriorate if the Products are stored in the places where:
  - [a] the Products are exposed to sea winds or corrosive gases, including Cl<sub>2</sub>, H<sub>2</sub>S, NH<sub>3</sub>, SO<sub>2</sub>, and NO<sub>2</sub>
  - [b] the temperature or humidity exceeds those recommended by ROHM
  - [c] the Products are exposed to direct sunshine or condensation
  - [d] the Products are exposed to high Electrostatic
2. Even under ROHM recommended storage condition, solderability of products out of recommended storage time period may be degraded. It is strongly recommended to confirm solderability before using Products of which storage time is exceeding the recommended storage time period.
3. Store / transport cartons in the correct direction, which is indicated on a carton with a symbol. Otherwise bent leads may occur due to excessive stress applied when dropping of a carton.
4. Use Products within the specified time after opening a humidity barrier bag. Baking is required before using Products of which storage time is exceeding the recommended storage time period.

### Precaution for Product Label

A two-dimensional barcode printed on ROHM Products label is for ROHM's internal use only.

### Precaution for Disposition

When disposing Products please dispose them properly using an authorized industry waste company.

### Precaution for Foreign Exchange and Foreign Trade act

Since concerned goods might be fallen under listed items of export control prescribed by Foreign exchange and Foreign trade act, please consult with ROHM in case of export.

### Precaution Regarding Intellectual Property Rights

1. All information and data including but not limited to application example contained in this document is for reference only. ROHM does not warrant that foregoing information or data will not infringe any intellectual property rights or any other rights of any third party regarding such information or data.
2. ROHM shall not have any obligations where the claims, actions or demands arising from the combination of the Products with other articles such as components, circuits, systems or external equipment (including software).
3. No license, expressly or implied, is granted hereby under any intellectual property rights or other rights of ROHM or any third parties with respect to the Products or the information contained in this document. Provided, however, that ROHM will not assert its intellectual property rights or other rights against you or your customers to the extent necessary to manufacture or sell products containing the Products, subject to the terms and conditions herein.

### Other Precaution

1. This document may not be reprinted or reproduced, in whole or in part, without prior written consent of ROHM.
2. The Products may not be disassembled, converted, modified, reproduced or otherwise changed without prior written consent of ROHM.
3. In no event shall you use in any way whatsoever the Products and the related technical information contained in the Products or this document for any military purposes, including but not limited to, the development of mass-destruction weapons.
4. The proper names of companies or products described in this document are trademarks or registered trademarks of ROHM, its affiliated companies or third parties.