

P-channel 20 V, 0.0195 Ω typ., 8 A STripFET™ VII DeepGATE™ Power MOSFET in a PowerFLAT™ 2x2 package

Datasheet - production data

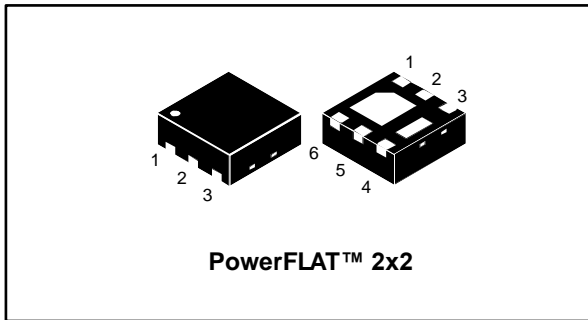
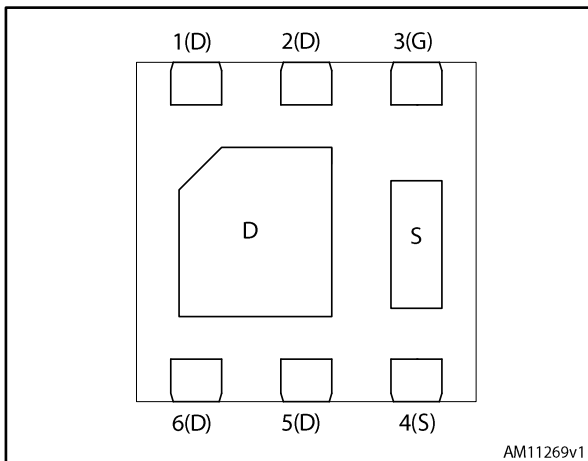

Figure 1: Internal schematic diagram



Features

Order code	V_{DS}	$R_{DS(on)max}$	I_D
STL8P2UH7	20 V	0.0225 Ω @ 4.5 V	8 A

- Extremely low on-resistance $R_{DS(on)}$
- Ultra logic level

Applications

- Switching applications

Description

This device exhibits low on-state resistance and capacitance for improved conduction and switching performance.

Table 1: Device summary

Order code	Marking	Package	Packaging
STL8P2UH7	8L2U	PowerFLAT™ 2x2	Tape and reel

 For the P-channel Power MOSFET the actual polarity of the voltages and the current must be reversed.

Contents

1	Electrical ratings	3
2	Electrical characteristics	4
	2.1 Electrical characteristics (curves)	6
3	Test circuits	8
4	Package mechanical data	9
	4.1 PowerFLAT™ 2x2 package mechanical data	10
5	Revision history	13

1 Electrical ratings

Table 2: Absolute maximum ratings

Symbol	Parameter	Value	Unit
V_{DS}	Drain-source voltage	20	V
V_{GS}	Gate-source voltage	± 8	V
I_D	Drain current (continuous) at $T_{pcb}= 25\text{ }^\circ\text{C}$	8	A
I_D	Drain current (continuous) at $T_{pcb}= 100\text{ }^\circ\text{C}$	5.3	A
$I_{DM}^{(1)}$	Drain current (pulsed)	32	A
P_{TOT}	Total dissipation at $T_{pcb}= 25\text{ }^\circ\text{C}$	2.4	W
T_{stg}	Storage temperature	- 55 to 150	$^\circ\text{C}$
T_j	Max. operating junction temperature	150	$^\circ\text{C}$

Notes:

⁽¹⁾Pulse width limited by safe operating area

Table 3: Thermal data

Symbol	Parameter	Value	Unit
$R_{thj-pcb}^{(1)}$	Thermal resistance junction-pcb max	52	$^\circ\text{C/W}$

Notes:

⁽¹⁾When mounted on 1inch² FR-4 board, 2 oz Cu



For the P-channel Power MOSFET the actual polarity of the voltages and the current must be reversed.

2 Electrical characteristics

($T_C = 25\text{ °C}$ unless otherwise specified)

Table 4: On /off states

Symbol	Parameter	Test conditions	Min.	Typ.	Max.	Unit
$V_{(BR)DSS}$	Drain-source breakdown voltage	$V_{GS} = 0, I_D = 250\text{ }\mu\text{A}$	20			V
I_{DSS}	Zero gate voltage drain current	$V_{GS} = 0, V_{DS} = 20\text{ V}$			1	μA
I_{GSS}	Gate-body leakage current	$V_{DS} = 0, V_{GS} = \pm 5\text{ V}$			± 5	μA
$V_{GS(th)}$	Gate threshold voltage	$V_{DS} = V_{GS}, I_D = 250\text{ }\mu\text{A}$	0.4		1	V
$R_{DS(on)}$	Static drain-source on- resistance	$V_{GS} = 4.5\text{ V}, I_D = 4\text{ A}$		0.0195	0.0225	Ω
		$V_{GS} = 2.5\text{ V}, I_D = 4\text{ A}$		0.02	0.025	Ω
		$V_{GS} = 1.8\text{ V}, I_D = 4\text{ A}$		0.036	0.043	Ω
		$V_{GS} = 1.5\text{ V}, I_D = 4\text{ A}$		0.05	0.085	Ω

Table 5: Dynamic

Symbol	Parameter	Test conditions	Min.	Typ.	Max.	Unit
C_{iss}	Input capacitance	$V_{GS} = 0, V_{DS} = 16\text{ V},$ $f = 1\text{ MHz}$	-	2390	-	pF
C_{oss}	Output capacitance		-	220	-	pF
C_{rss}	Reverse transfer capacitance		-	188	-	pF
Q_g	Total gate charge	$V_{DD} = 16\text{ V}, I_D = 8\text{ A},$ $V_{GS} = 4.5\text{ V}$	-	22	-	nC
Q_{gs}	Gate-source charge		-	4.2	-	nC
Q_{gd}	Gate-drain charge		-	3.6	-	nC



For the P-channel Power MOSFET the actual polarity of the voltages and the current must be reversed.

Table 6: Switching times

Symbol	Parameter	Test conditions	Min.	Typ.	Max	Unit
$t_{d(on)}$	Turn-on delay time	$V_{DD} = 16\text{ V}, I_D = 8\text{ A},$ $R_G = 1\text{ }\Omega, V_{GS} = 4.5\text{ V}$	-	12.5	-	ns
t_r	Rise time		-	30.5	-	ns
$t_{d(off)}$	Turn-off delay time		-	128	-	ns
t_f	Fall time		-	84.5	-	ns

Table 7: Source drain diode

Symbol	Parameter	Test conditions	Min.	Typ.	Max.	Unit
I_{SD}	Source-drain current		-		8	A
$I_{SDM}^{(1)}$	Source-drain current (pulsed)		-		32	A
$V_{SD}^{(2)}$	Forward on voltage	$V_{GS}=0, I_{SD}=1\text{ A}$	-		1	V
t_{rr}	Reverse recovery time	$V_{DD}=16\text{ V}$ $di/dt = 100\text{ A}/\mu\text{s}$, $I_{SD}=1\text{ A}$	-	15.8		ns
Q_{rr}	Reverse recovery charge		-	5.9		nC
I_{RRM}	Reverse recovery current		-	0.7		A

Notes:

⁽¹⁾Pulse width limited by safe operating area.

⁽²⁾Pulsed: pulse duration = 300 μs , duty cycle 1.5%



For the P-channel Power MOSFET the actual polarity of the voltages and the current must be reversed.

2.1 Electrical characteristics (curves)

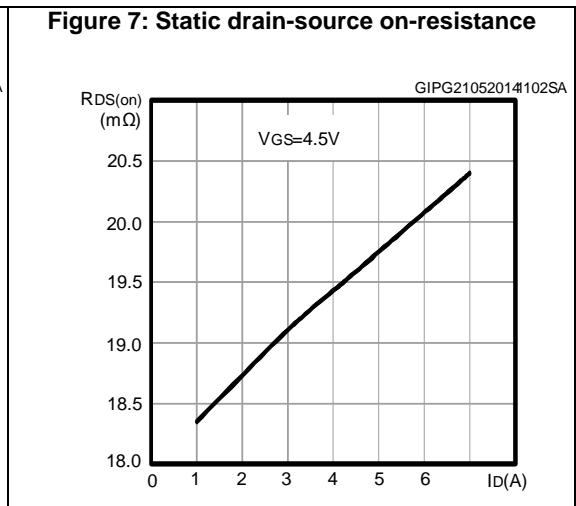
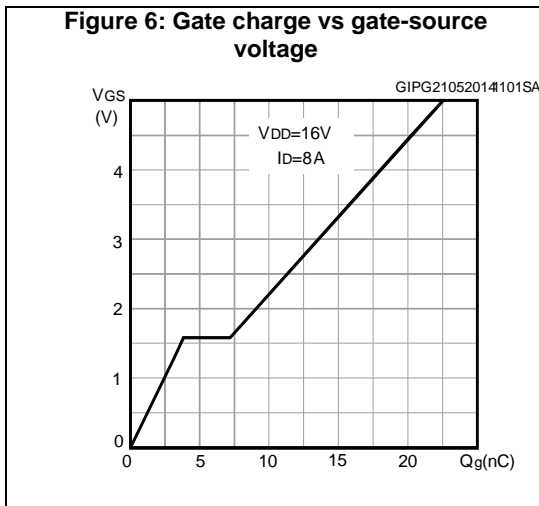
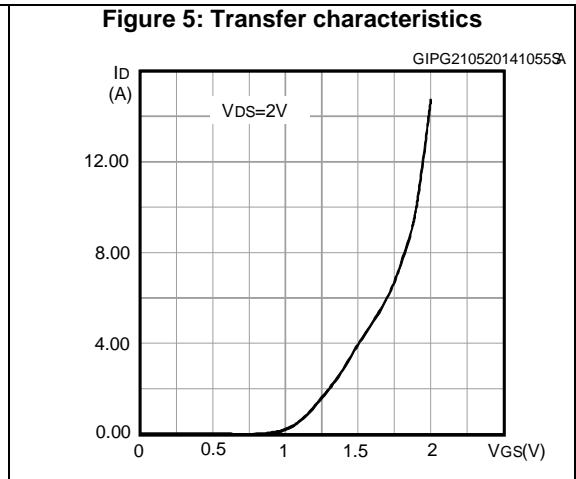
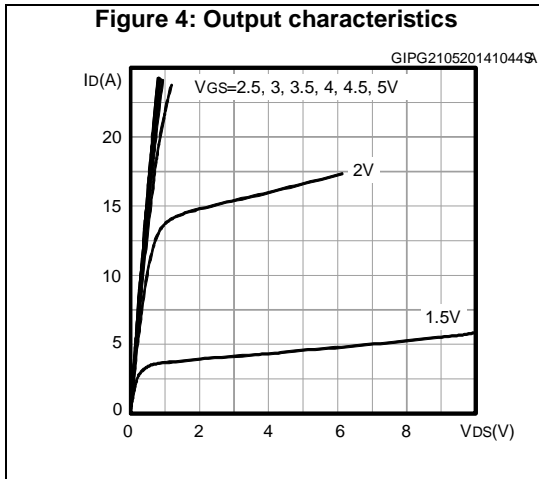
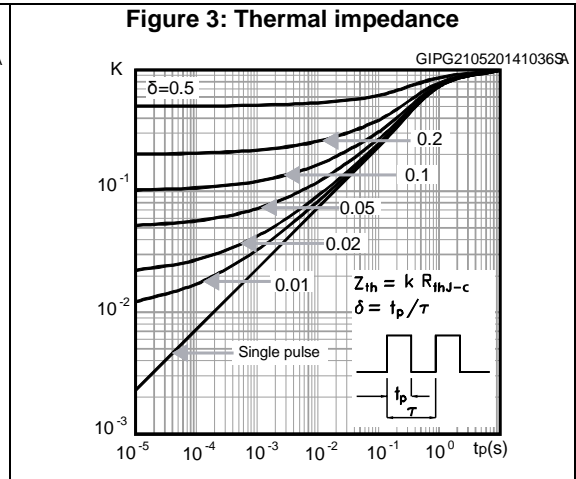
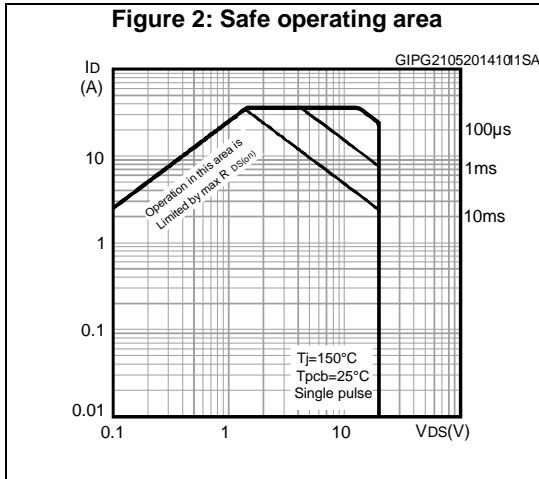

Figure 8: Capacitance variations

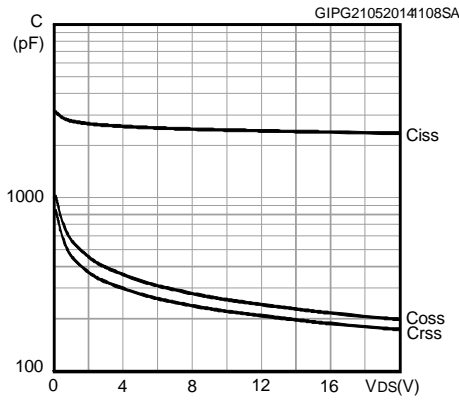

Figure 9: Normalized gate threshold voltage vs temperature

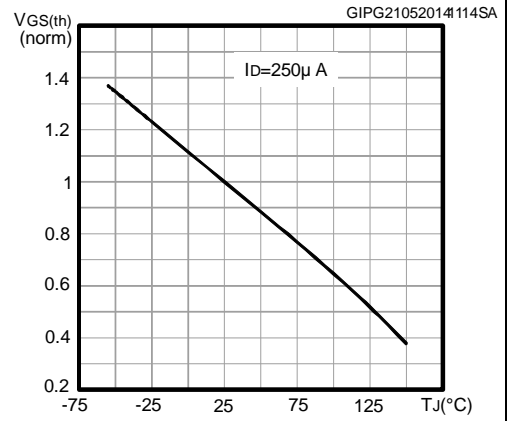

Figure 10: Normalized on-resistance vs temperature

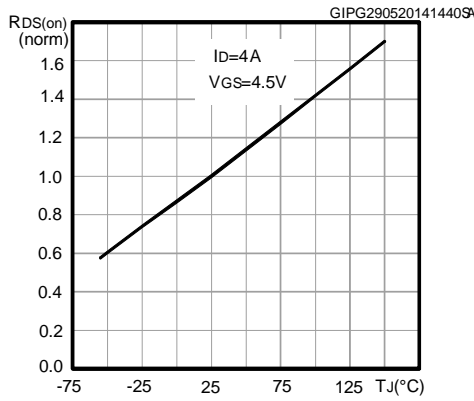

Figure 11: Normalized V(BR)DSS vs temperature

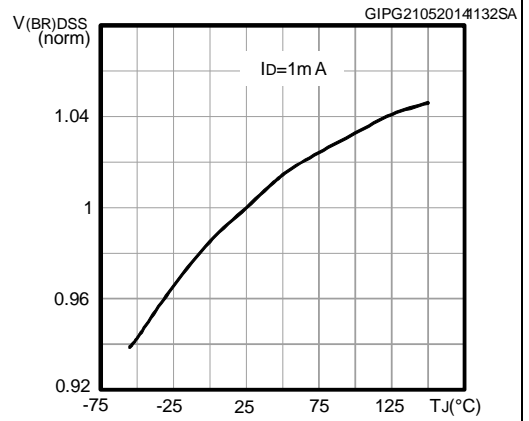
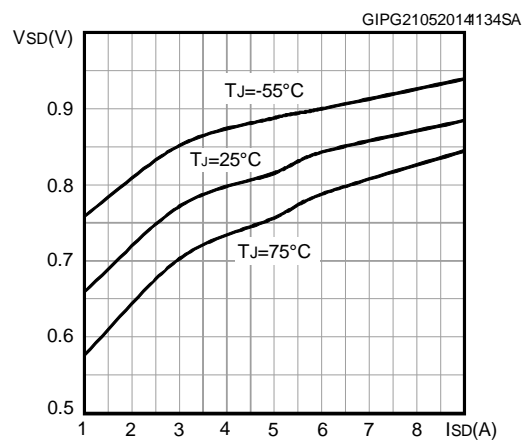

Figure 12: Source-drain diode forward characteristics



3 Test circuits

Figure 13: Switching times test circuit for resistive load

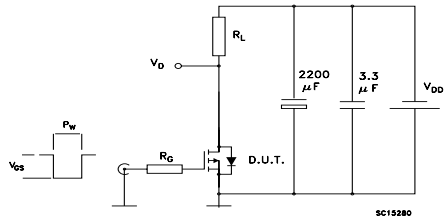

Figure 14: Gate charge test circuit

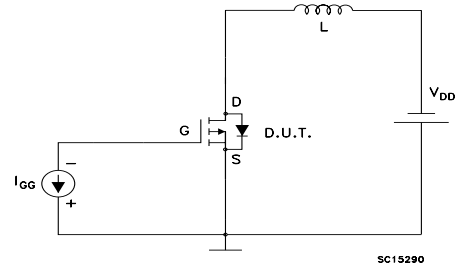
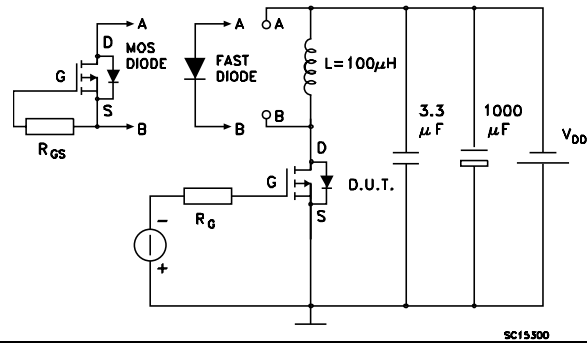

Figure 15: Test circuit for inductive load switching and diode recovery times



4 Package mechanical data

In order to meet environmental requirements, ST offers these devices in different grades of ECOPACK[®] packages, depending on their level of environmental compliance. ECOPACK[®] specifications, grade definitions and product status are available at: www.st.com. ECOPACK[®] is an ST trademark.

4.1 PowerFLAT™ 2x2 package mechanical data

Figure 16: Drawing dimension PowerFLAT™ 2 x 2

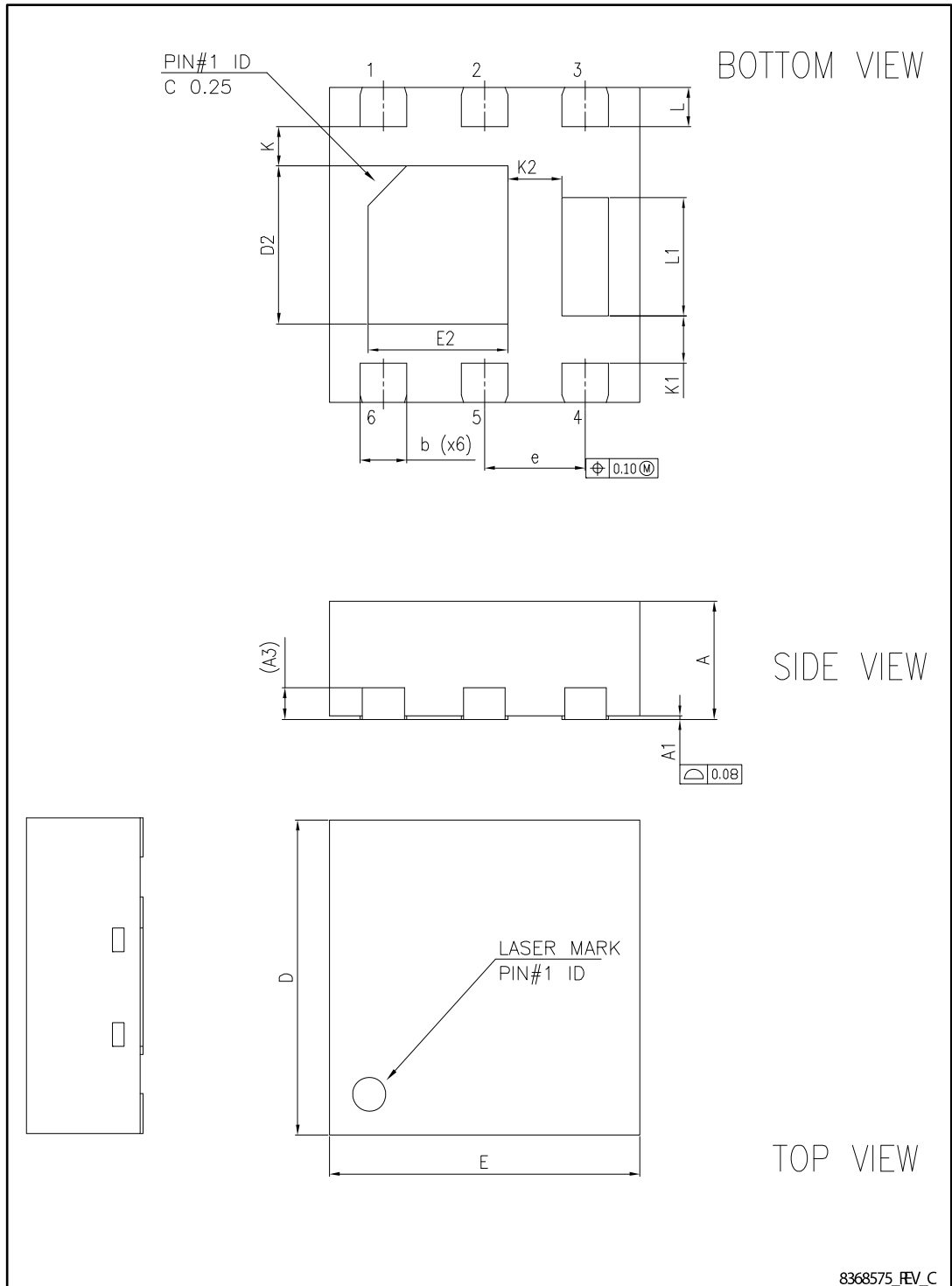
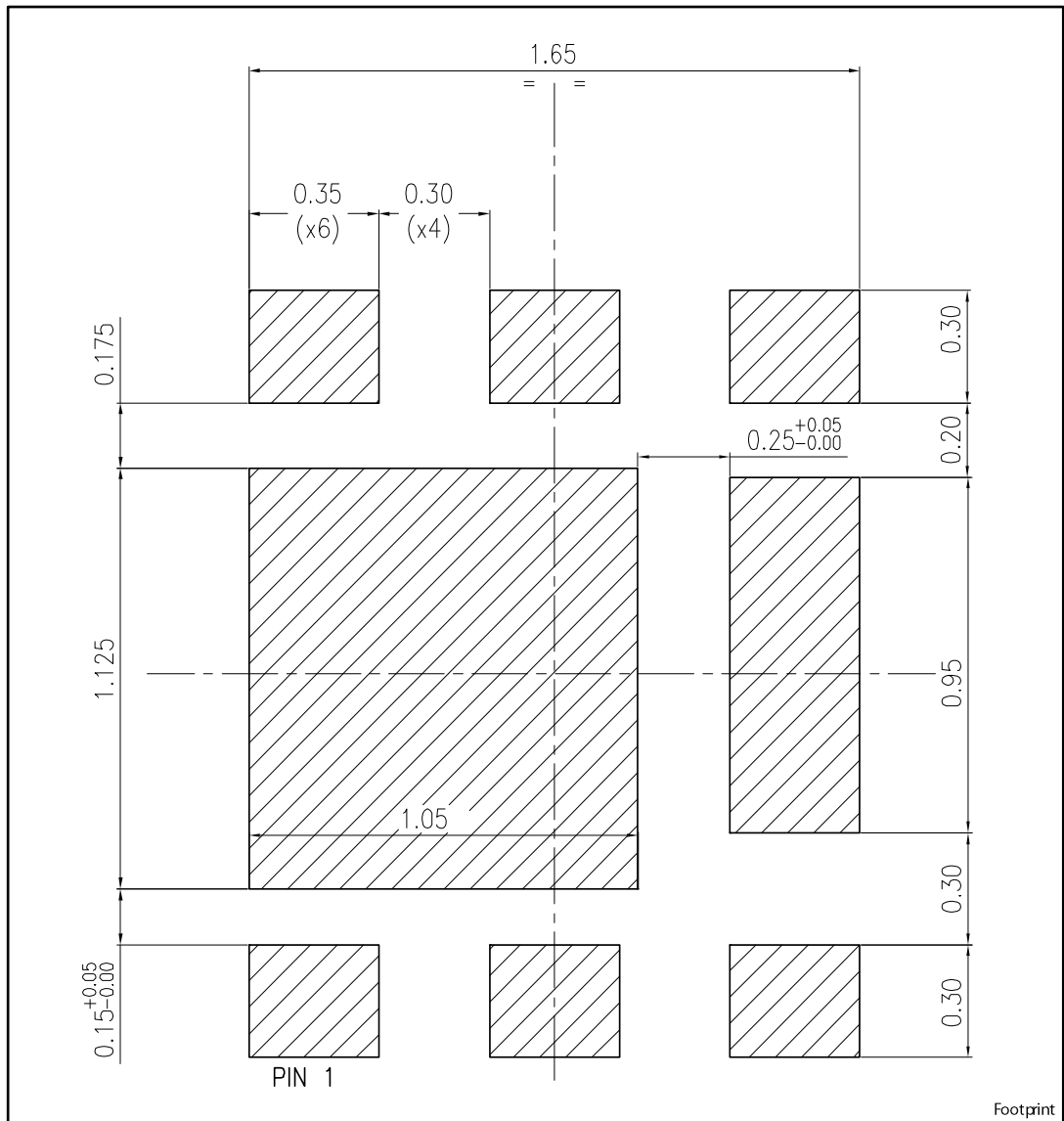

Table 8: PowerFLAT™ 2 x 2 mechanical data

Dim.	mm.		
	Min.	Typ.	Max.
A	0.70	0.75	0.80
A1	0.00	0.02	0.05
A3		0.20	
b	0.25	0.30	0.35
D	1.90	2.00	2.10
E	1.90	2.00	2.10
D2	0.90	1.00	1.10
E2	0.80	0.90	1.00
e	0.55	0.65	0.75
K	0.15	0.25	0.35
K1	0.20	0.30	0.40
K2	0.25	0.35	0.45
L	0.20	0.25	0.30
L1	0.65	0.75	0.85

Figure 17: PowerFLAT™ 2 x 2 footprint



5 Revision history

Table 9: Document revision history

Date	Revision	Changes
20-Aug-2013	1	First release.
04-Jun-2014	2	Document status promoted from preliminary data to production data Modified: title Modified: $R_{DS(on)}$ max value in cover page Modified: $R_{DS(on)}$ (typical and maximum) values in Table 4: "On /off states" Modified: the entire typical values in Table 5: "Dynamic" , Table 6: "Switching times" and Table 7: "Source drain diode" Added Section 8.1: "Electrical characteristics (curves)" Minor text changes

Please Read Carefully

Information in this document is provided solely in connection with ST products. STMicroelectronics NV and its subsidiaries ("ST") reserve the right to make changes, corrections, modifications or improvements, to this document, and the products and services described herein at any time, without notice.

All ST products are sold pursuant to ST's terms and conditions of sale.

Purchasers are solely responsible for the choice, selection and use of the ST products and services described herein, and ST assumes no liability whatsoever relating to the choice, selection or use of the ST products and services described herein.

No license, express or implied, by estoppel or otherwise, to any intellectual property rights is granted under this document. If any part of this document refers to any third party products or services it shall not be deemed a license grant by ST for the use of such third party products or services, or any intellectual property contained therein or considered as a warranty covering the use in any manner whatsoever of such third party products or services or any intellectual property contained therein.

UNLESS OTHERWISE SET FORTH IN ST'S TERMS AND CONDITIONS OF SALE ST DISCLAIMS ANY EXPRESS OR IMPLIED WARRANTY WITH RESPECT TO THE USE AND/OR SALE OF ST PRODUCTS INCLUDING WITHOUT LIMITATION IMPLIED WARRANTIES OF MERCHANTABILITY, FITNESS FOR A PARTICULAR PURPOSE (AND THEIR EQUIVALENTS UNDER THE LAWS OF ANY JURISDICTION), OR INFRINGEMENT OF ANY PATENT, COPYRIGHT OR OTHER INTELLECTUAL PROPERTY RIGHT.

ST PRODUCTS ARE NOT DESIGNED OR AUTHORIZED FOR USE IN: (A) SAFETY CRITICAL APPLICATIONS SUCH AS LIFE SUPPORTING, ACTIVE IMPLANTED DEVICES OR SYSTEMS WITH PRODUCT FUNCTIONAL SAFETY REQUIREMENTS; (B) AERONAUTIC APPLICATIONS; (C) AUTOMOTIVE APPLICATIONS OR ENVIRONMENTS, AND/OR (D) AEROSPACE APPLICATIONS OR ENVIRONMENTS. WHERE ST PRODUCTS ARE NOT DESIGNED FOR SUCH USE, THE PURCHASER SHALL USE PRODUCTS AT PURCHASER'S SOLE RISK, EVEN IF ST HAS BEEN INFORMED IN WRITING OF SUCH USAGE, UNLESS A PRODUCT IS EXPRESSLY DESIGNATED BY ST AS BEING INTENDED FOR "AUTOMOTIVE, AUTOMOTIVE SAFETY OR MEDICAL" INDUSTRY DOMAINS ACCORDING TO ST PRODUCT DESIGN SPECIFICATIONS. PRODUCTS FORMALLY ESCC, QML OR JAN QUALIFIED ARE DEEMED SUITABLE FOR USE IN AEROSPACE BY THE CORRESPONDING GOVERNMENTAL AGENCY.

Resale of ST products with provisions different from the statements and/or technical features set forth in this document shall immediately void any warranty granted by ST for the ST product or service described herein and shall not create or extend in any manner whatsoever, any liability of ST.

ST and the ST logo are trademarks or registered trademarks of ST in various countries.

Information in this document supersedes and replaces all information previously supplied.

The ST logo is a registered trademark of STMicroelectronics. All other names are the property of their respective owners.

© 2014 STMicroelectronics - All rights reserved

STMicroelectronics group of companies

Australia - Belgium - Brazil - Canada - China - Czech Republic - Finland - France - Germany - Hong Kong - India - Israel - Italy - Japan - Malaysia - Malta - Morocco - Philippines - Singapore - Spain - Sweden - Switzerland - United Kingdom - United States of America

www.st.com