



勝特力材料 886-3-5753170  
 勝特力电子(上海) 86-21-54151736  
 勝特力电子(深圳) 86-755-83298787  
[Http://www.100y.com.tw](http://www.100y.com.tw)

# Surface Mount RF Schottky Barrier Diodes

## Technical Data

### HSMS-281x Series

#### Features

- Surface Mount Packages
- Low Flicker Noise
- Low FIT (Failure in Time) Rate\*
- Six-sigma Quality Level
- Single, Dual and Quad Versions
- Tape and Reel Options Available
- Lead-free Option Available

\* For more information see the Surface Mount Schottky Reliability Data Sheet.

#### Description/Applications

These Schottky diodes are specifically designed for both analog and digital applications. This series offers a wide range of specifications and package configurations to give the designer wide flexibility. The HSMS-281x series of diodes features very low flicker (1/f) noise.

Note that Agilent's manufacturing techniques assure that dice found in pairs and quads are taken from adjacent sites on the wafer, assuring the highest degree of match.

#### Package Lead Code Identification, SOT-23/SOT-143 (Top View)

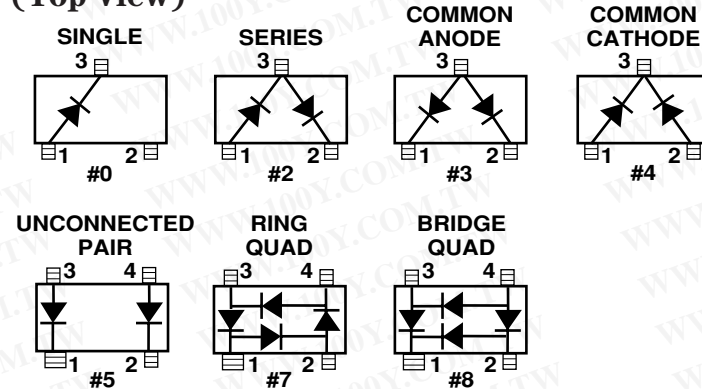

#### Package Lead Code Identification, SOT-323 (Top View)

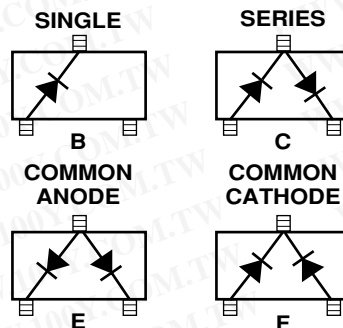

#### Package Lead Code Identification, SOT-363 (Top View)

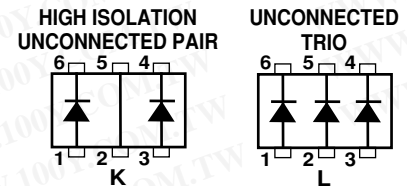

#### Pin Connections and Package Marking

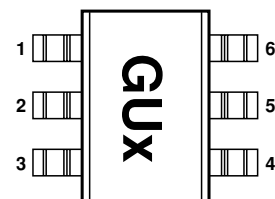

#### Notes:

1. Package marking provides orientation and identification.
2. See "Electrical Specifications" for appropriate package marking.

勝特力材料 886-3-5753170  
 勝特力电子(上海) 86-21-54151736  
 勝特力电子(深圳) 86-755-83298787  
[Http://www.100y.com.tw](http://www.100y.com.tw)

### Absolute Maximum Ratings<sup>[1]</sup> $T_C = 25^\circ\text{C}$

| Symbol        | Parameter                               | Unit                      | SOT-23/SOT-143   | SOT-323/SOT-363  |
|---------------|---|---------------------------|------------------|------------------|
| $I_f$         | Forward Current (1 $\mu\text{s}$ Pulse) | Amp                       | 1                | 1                |
| $P_{IV}$      | Peak Inverse Voltage                    | V                         | Same as $V_{BR}$ | Same as $V_{BR}$ |
| $T_j$         | Junction Temperature                    | $^\circ\text{C}$          | 150              | 150              |
| $T_{stg}$     | Storage Temperature                     | $^\circ\text{C}$          | -65 to 150       | -65 to 150       |
| $\theta_{jc}$ | Thermal Resistance <sup>[2]</sup>       | $^\circ\text{C}/\text{W}$ | 500              | 150              |

#### Notes:

1. Operation in excess of any one of these conditions may result in permanent damage to the device.
2.  $T_C = +25^\circ\text{C}$ , where  $T_C$  is defined to be the temperature at the package pins where contact is made to the circuit board.

#### ESD WARNING:

Handling Precautions Should Be Taken To Avoid Static Discharge.

### Electrical Specifications $T_C = 25^\circ\text{C}$ , Single Diode<sup>[4]</sup>

| Part Number<br>HSMS <sup>[5]</sup> | Package Marking Code | Lead Code | Configuration                      | Minimum Breakdown Voltage<br>$V_{BR}$ (V) | Maximum Forward Voltage<br>$V_F$ (mV) | Maximum Forward Voltage<br>$V_F$ (V) @<br>$I_F$ (mA) | Maximum Reverse Leakage<br>$I_R$ (nA) @<br>$V_R$ (V) | Maximum Capacitance<br>$C_T$ (pF) | Typical Dynamic Resistance<br>$R_D$ ( $\Omega$ ) <sup>[6]</sup> |                        |                     |  |  |                     |
|------------------------------------|----------------------|-----------|------------------------------------|---|---------------------------------------|--|--|-----------------------------------|---|------------------------|---------------------|--|--|---------------------|
| 2810                               | B0 <sup>[3]</sup>    | 0         | Single                             | 20  | 400                                   | 1.0 35   | 200 15   | 1.2                               | 15  |                        |                     |  |  |                     |
| 2812                               | B2 <sup>[3]</sup>    | 2         | Series                             |   |                                       |  |  |                                   |   |                        |                     |  |  |                     |
| 2813                               | B3 <sup>[3]</sup>    | 3         | Common Anode                       |   |                                       |  |  |                                   |   |                        |                     |  |  |                     |
| 2814                               | B4 <sup>[3]</sup>    | 4         | Common Cathode                     |   |                                       |  |  |                                   |   |                        |                     |  |  |                     |
| 2815                               | B5 <sup>[3]</sup>    | 5         | Unconnected Pair                   |   |                                       |  |  |                                   |   |                        |                     |  |  |                     |
| 2817                               | B7 <sup>[3]</sup>    | 7         | Ring Quad <sup>[5]</sup>           |   |                                       |  |  |                                   |   |                        |                     |  |  |                     |
| 2818                               | B8 <sup>[3]</sup>    | 8         | Bridge Quad <sup>[5]</sup>         |   |                                       |  |  |                                   |   |                        |                     |  |  |                     |
| 281B                               | B0 <sup>[7]</sup>    | B         | Single                             |   |                                       |  |  |                                   |   |                        |                     |  |  |                     |
| 281C                               | B2 <sup>[7]</sup>    | C         | Series                             |   |                                       |  |  |                                   |   |                        |                     |  |  |                     |
| 281E                               | B3 <sup>[7]</sup>    | E         | Common Anode                       |   |                                       |  |  |                                   |   |                        |                     |  |  |                     |
| 281F                               | B4 <sup>[7]</sup>    | F         | Common Cathode                     |   |                                       |  |  |                                   |   |                        |                     |  |  |                     |
| 281K                               | BK <sup>[7]</sup>    | K         | High Isolation<br>Unconnected Pair |   |                                       |  |  |                                   |   |                        |                     |  |  |                     |
| 281L                               | BL <sup>[7]</sup>    | L         | Unconnected Trio                   |   |                                       |  |  |                                   |   |                        |                     |  |  |                     |
| Test Conditions                    |                      |           |                                    |   |                                       |  |  |                                   |   | $I_R = 10 \mu\text{A}$ | $I_F = 1 \text{mA}$ |  | $V_F = 0 \text{V}$<br>$f = 1 \text{MHz}$ | $I_F = 5 \text{mA}$ |

#### Notes:

1.  $\Delta V_F$  for diodes in pairs and quads in 15 mV maximum at 1 mA.
2.  $\Delta C_{TO}$  for diodes in pairs and quads is 0.2 pF maximum.
3. Package marking code is in white.
4. Effective Carrier Lifetime ( $\tau$ ) for all these diodes is 100 ps maximum measured with Krakauer method at 5 mA.
5. See section titled "Quad Capacitance."
6.  $R_D = R_S + 5.2 \Omega$  at  $25^\circ\text{C}$  and  $I_F = 5 \text{mA}$ .
7. Package marking code is laser marked.

## Quad Capacitance

Capacitance of Schottky diode quads is measured using an HP4271 LCR meter. This instrument effectively isolates individual diode branches from the others, allowing accurate capacitance measurement of each branch or each diode. The conditions are: 20 mV R.M.S. voltage at 1 MHz. Agilent defines this measurement as "CM", and it is equivalent to the capacitance of the diode by itself. The equivalent diagonal and adjacent capacitances can then be calculated by the formulas given below.

In a quad, the diagonal capacitance is the capacitance between points A and B as shown in the figure below. The diagonal capacitance is calculated using the following formula

$$C_{\text{DIAGONAL}} = \frac{C_1 \times C_2}{C_1 + C_2} + \frac{C_3 \times C_4}{C_3 + C_4}$$

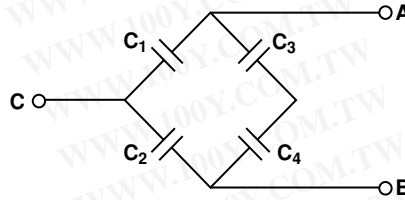

The equivalent adjacent capacitance is the capacitance between points A and C in the figure below. This capacitance is calculated using the following formula

$$C_{\text{ADJACENT}} = C_1 + \frac{1}{\frac{1}{C_2} + \frac{1}{C_3} + \frac{1}{C_4}}$$

## Linear Equivalent Circuit, Diode Chip

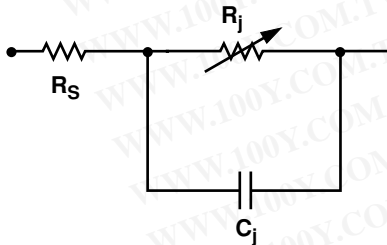

$R_S$  = series resistance (see Table of SPICE parameters)

$C_j$  = junction capacitance (see Table of SPICE parameters)

$$R_j = \frac{8.33 \times 10^{-5} \text{ nT}}{I_b + I_s}$$

where

$I_b$  = externally applied bias current in amps

$I_s$  = saturation current (see table of SPICE parameters)

$T$  = temperature, °K

$n$  = ideality factor (see table of SPICE parameters)

Note:

To effectively model the packaged HSMS-281x product, please refer to Application Note AN1124.

## SPICE Parameters

| Parameter | Units    | HSMS-281x |
|-----------|----------|-----------|
| $B_V$     | V        | 25        |
| $C_{J0}$  | pF       | 1.1       |
| $E_G$     | eV       | 0.69      |
| $I_{BV}$  | A        | E-5       |
| $I_S$     | A        | 4.8E-9    |
| $N$       |          | 1.08      |
| $R_S$     | $\Omega$ | 10        |
| $P_B$     | V        | 0.65      |
| $P_T$     |          | 2         |
| $M$       |          | 0.5       |

## Typical Performance, $T_C = 25^\circ\text{C}$ (unless otherwise noted), Single Diode

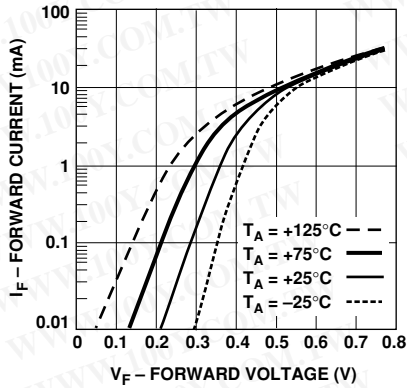

Figure 1. Forward Current vs. Forward Voltage at Temperatures.

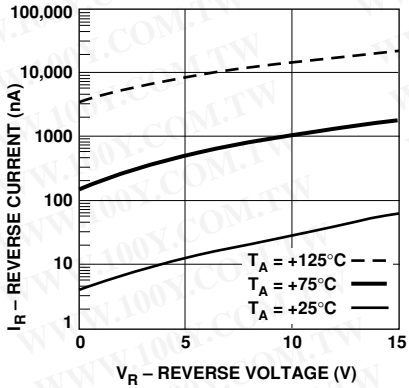

Figure 2. Reverse Current vs. Reverse Voltage at Temperatures.

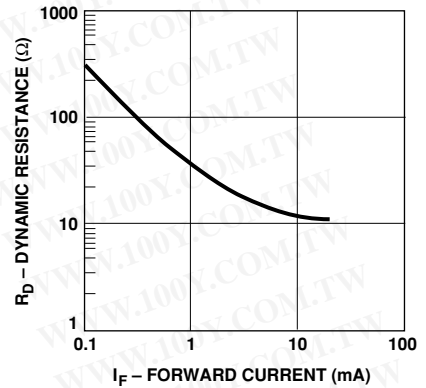

Figure 3. Dynamic Resistance vs. Forward Current.

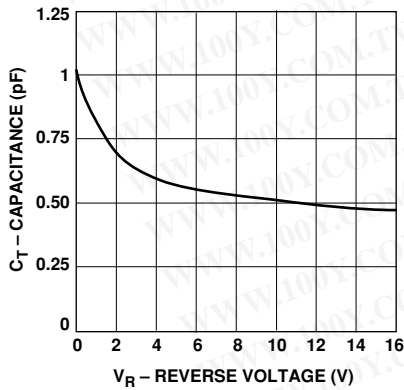

Figure 4. Total Capacitance vs. Reverse Voltage.

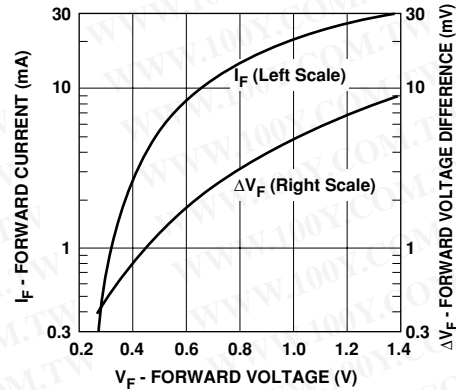

Figure 5. Typical  $V_f$  Match, Pairs and Quads.

## Applications Information

### Introduction— Product Selection

Agilent's family of Schottky products provides unique solutions to many design problems.

The first step in choosing the right product is to select the diode type. All of the products in the HSMS-282x family use the same diode chip, and the same is true of the HSMS-281x and HSMS-280x families. Each family has a different set of characteristics which can be compared most easily by consulting the SPICE parameters in Table 1.

A review of these data shows that the HSMS-280x family has the highest breakdown voltage, but at the expense of a high value of series resistance ( $R_S$ ). In applications which do not require high voltage the HSMS-282x family, with a lower value of series

resistance, will offer higher current carrying capacity and better performance. The HSMS-281x family is a hybrid Schottky (as is the HSMS-280x), offering lower 1/f or flicker noise than the HSMS-282x family.

In general, the HSMS-282x family should be the designer's first choice, with the -280x family reserved for high voltage applications and the HSMS-281x family for low flicker noise applications.

## Assembly Instructions

### SOT-323 PCB Footprint

A recommended PCB pad layout for the miniature SOT-323 (SC-70) package is shown in Figure 6 (dimensions are in inches). This layout provides ample allowance for package placement by automated assembly equipment without adding parasitics that could impair the performance.

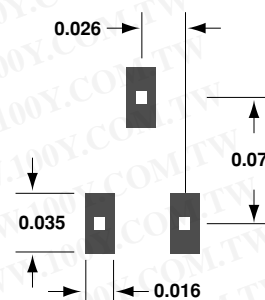

Figure 6. PCB Pad Layout (dimensions in inches).

### Assembly Instructions SOT-363 PCB Footprint

A recommended PCB pad layout for the miniature SOT-363 (SC-70, 6 lead) package is shown in Figure 7 (dimensions are in inches). This layout provides ample allowance for package placement by automated assembly equipment without adding parasitics that could impair the performance.

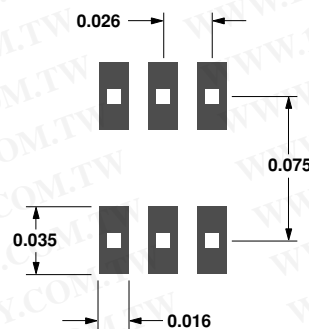

Figure 7. PCB Pad Layout (dimensions in inches).

Table 1. Typical SPICE Parameters.

| Parameter  | Units    | HSMS-280x | HSMS-281x | HSMS-282x |
|------------|----------|-----------|-----------|-----------|
| $B_V$      | V        | 75        | 25        | 15        |
| $C_{J0}$   | pF       | 1.6       | 1.1       | 0.7       |
| $E_G$      | eV       | 0.69      | 0.69      | 0.69      |
| $I_{BV}$   | A        | 1 E-5     | 1 E-5     | 1 E-4     |
| $I_S$      | A        | 3 E-8     | 4.8 E-9   | 2.2 E-8   |
| N          |          | 1.08      | 1.08      | 1.08      |
| $R_S$      | $\Omega$ | 30        | 10        | 6.0       |
| $P_B(V_J)$ | V        | 0.65      | 0.65      | 0.65      |
| $P_T(XTI)$ |          | 2         | 2         | 2         |
| M          |          | 0.5       | 0.5       | 0.5       |

### SMT Assembly

Reliable assembly of surface mount components is a complex process that involves many material, process, and equipment factors, including: method of heating (e.g., IR or vapor phase reflow, wave soldering, etc.) circuit board material, conductor thickness and pattern, type of solder alloy, and the thermal conductivity and thermal mass of components. Components with a low mass, such as the SOT package, will reach solder reflow temperatures faster than those with a greater mass.

Agilent's SOT diodes have been qualified to the time-temperature profile shown in Figure 8. This profile is representative of an IR reflow type of surface mount assembly process.

After ramping up from room temperature, the circuit board with components attached to it (held in place with solder paste) passes through one or more preheat zones. The preheat zones increase the temperature of the board and components to prevent thermal shock and begin evaporating solvents from the solder paste. The reflow zone briefly elevates the temperature sufficiently to produce a reflow of the solder.

The rates of change of temperature for the ramp-up and cool-down zones are chosen to be low enough to not cause deformation of the board or damage to components due to thermal shock. The maximum temperature in the reflow zone ( $T_{MAX}$ ) should not exceed 235°C.

These parameters are typical for a surface mount assembly process for Agilent diodes. As a general guideline, the circuit board and components should be exposed only to the minimum temperatures and times necessary to achieve a uniform reflow of solder.

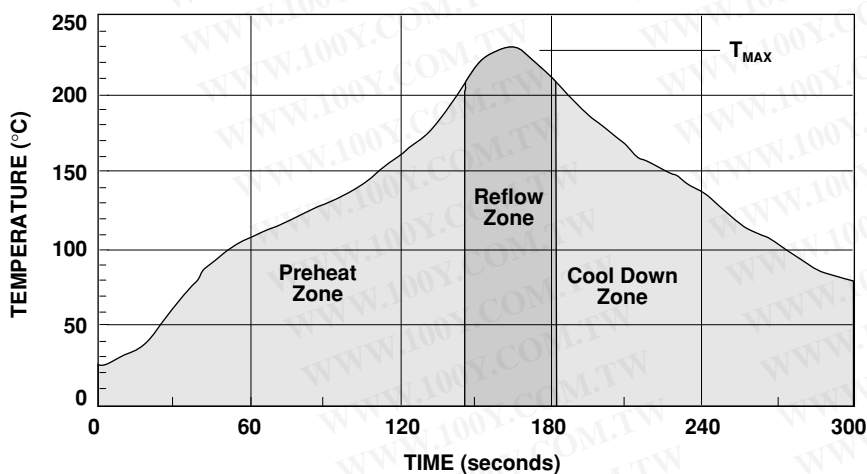

Figure 8. Surface Mount Assembly Profile.

### Part Number Ordering Information

| Part Number    | No. of Devices | Container      |
|----------------|----------------|----------------|
| HSMS-281x-TR2* | 10000          | 13" Reel       |
| HSMS-281x-TR1* | 3000           | 7" Reel        |
| HSMS-281x-BLK* | 100            | antistatic bag |

x = 0, 2, 3, 4, 5, 7, 8, B, C, E, F, K, L

For lead-free option, the part number will have the character "G" at the end, eg. HSMS-281x-TR2G for a 10,000 lead-free reel.

### Package Dimensions

#### Outline 23 (SOT-23)

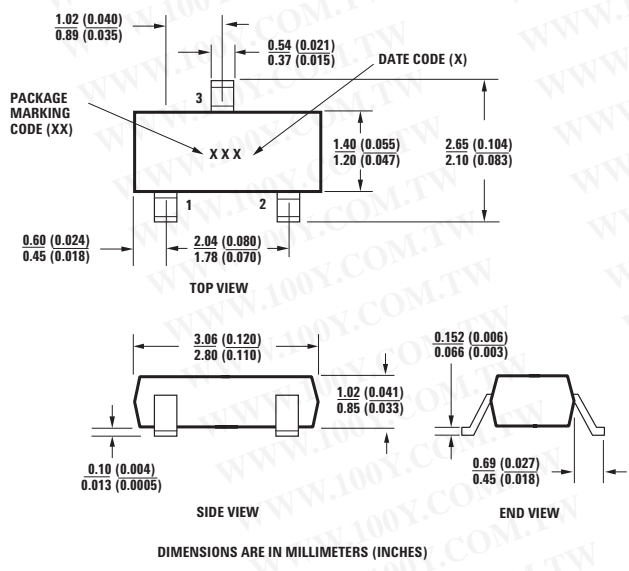

#### Outline SOT-323 (SC-70 3 Lead)

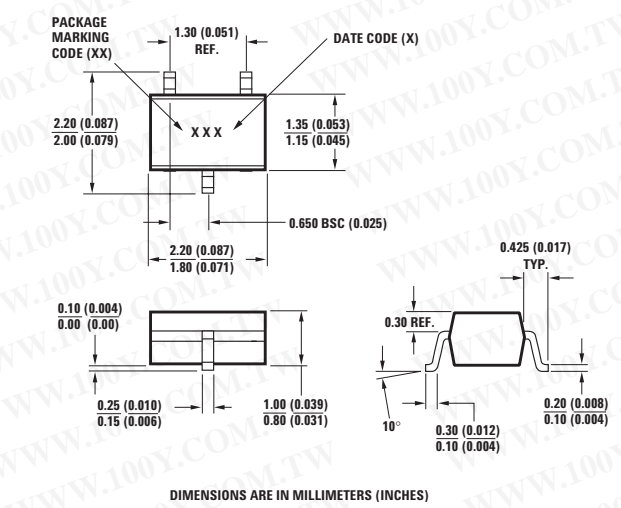

#### Outline 143 (SOT-143)

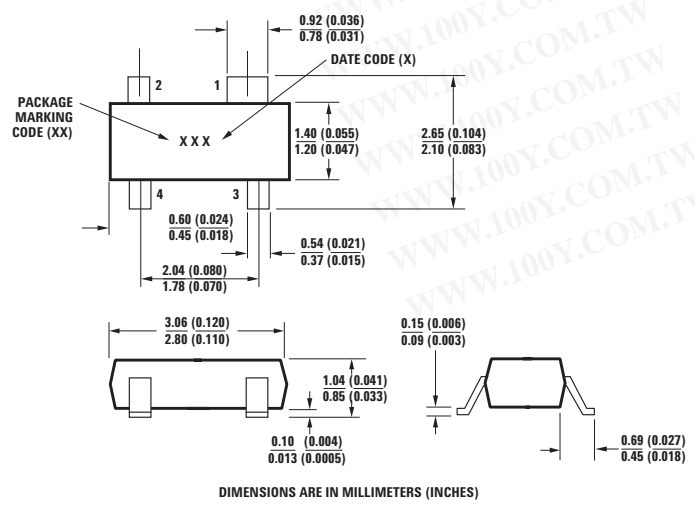

#### Outline SOT-363 (SC-70 6 Lead)

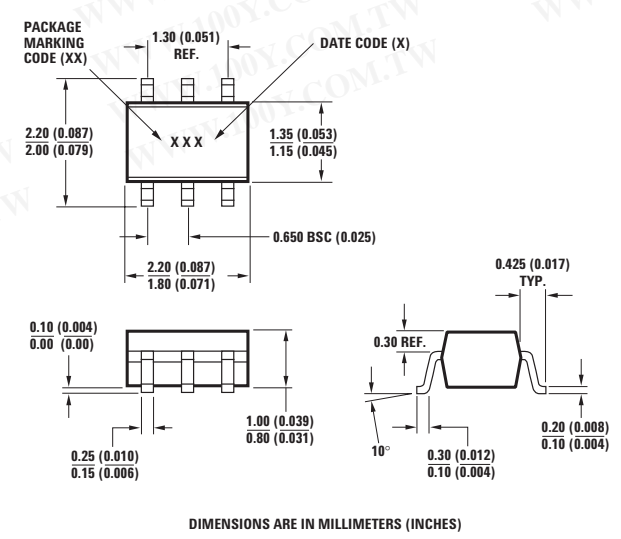

**Device Orientation**

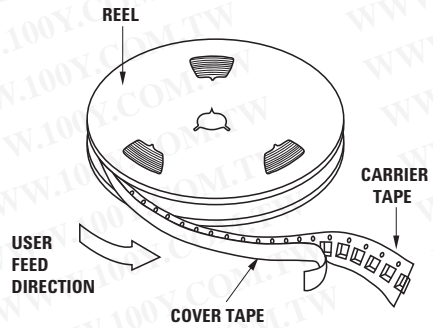

**For Outlines SOT-23, -323**

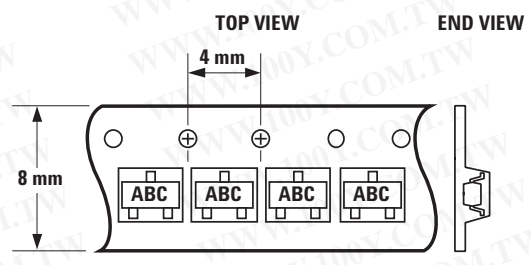

Note: "AB" represents package marking code.  
"C" represents date code.

**For Outline SOT-143**

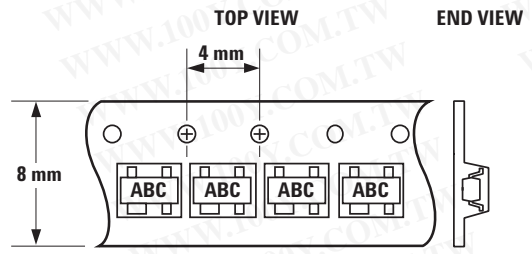

Note: "AB" represents package marking code.  
"C" represents date code.

**For Outline SOT-363**

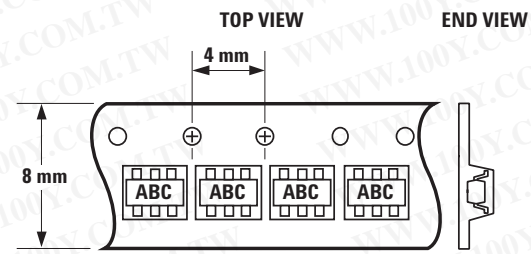

Note: "AB" represents package marking code.  
"C" represents date code.



## Tape Dimensions and Product Orientation For Outline SOT-23

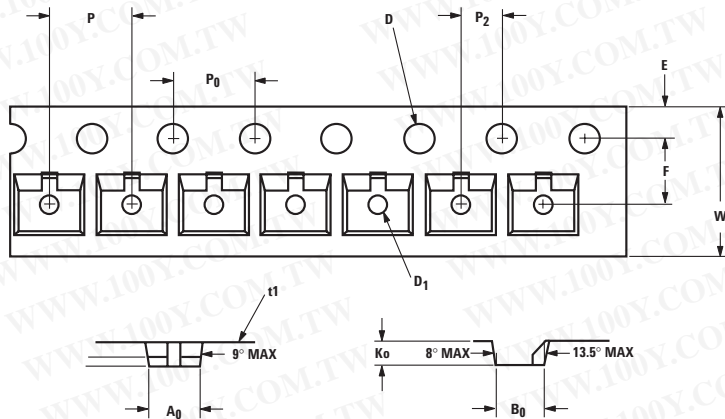

|                             | DESCRIPTION                              | SYMBOL | SIZE (mm)            | SIZE (INCHES)           |
|-----------------------------|--|--------|----------------------|-------------------------|
| CAVITY                      | LENGTH                                   | $A_0$  | $3.15 \pm 0.10$      | $0.124 \pm 0.004$       |
|                             | WIDTH                                    | $B_0$  | $2.77 \pm 0.10$      | $0.109 \pm 0.004$       |
|                             | DEPTH                                    | $K_0$  | $1.22 \pm 0.10$      | $0.048 \pm 0.004$       |
|                             | PITCH                                    | $P$    | $4.00 \pm 0.10$      | $0.157 \pm 0.004$       |
|                             | BOTTOM HOLE DIAMETER                     | $D_1$  | $1.00 + 0.05$        | $0.039 \pm 0.002$       |
| PERFORATION                 | DIAMETER                                 | $D$    | $1.50 + 0.10$        | $0.059 + 0.004$         |
|                             | PITCH                                    | $P_0$  | $4.00 \pm 0.10$      | $0.157 \pm 0.004$       |
|                             | POSITION                                 | $E$    | $1.75 \pm 0.10$      | $0.069 \pm 0.004$       |
| CARRIER TAPE                | WIDTH                                    | $W$    | $8.00 + 0.30 - 0.10$ | $0.315 + 0.012 - 0.004$ |
|                             | THICKNESS                                | $t_1$  | $0.229 \pm 0.013$    | $0.009 \pm 0.0005$      |
| DISTANCE BETWEEN CENTERLINE | CAVITY TO PERFORATION (WIDTH DIRECTION)  | $F$    | $3.50 \pm 0.05$      | $0.138 \pm 0.002$       |
|                             | CAVITY TO PERFORATION (LENGTH DIRECTION) | $P_2$  | $2.00 \pm 0.05$      | $0.079 \pm 0.002$       |

## For Outline SOT-143

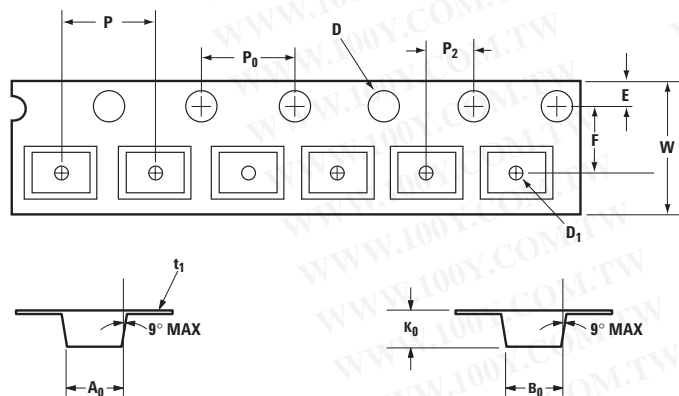

|              | DESCRIPTION                              | SYMBOL | SIZE (mm)            | SIZE (INCHES)           |
|--------------|--|--------|----------------------|-------------------------|
| CAVITY       | LENGTH                                   | $A_0$  | $3.19 \pm 0.10$      | $0.126 \pm 0.004$       |
|              | WIDTH                                    | $B_0$  | $2.80 \pm 0.10$      | $0.110 \pm 0.004$       |
|              | DEPTH                                    | $K_0$  | $1.31 \pm 0.10$      | $0.052 \pm 0.004$       |
|              | PITCH                                    | $P$    | $4.00 \pm 0.10$      | $0.157 \pm 0.004$       |
|              | BOTTOM HOLE DIAMETER                     | $D_1$  | $1.00 + 0.25$        | $0.039 + 0.010$         |
| PERFORATION  | DIAMETER                                 | $D$    | $1.50 + 0.10$        | $0.059 + 0.004$         |
|              | PITCH                                    | $P_0$  | $4.00 \pm 0.10$      | $0.157 \pm 0.004$       |
|              | POSITION                                 | $E$    | $1.75 \pm 0.10$      | $0.069 \pm 0.004$       |
| CARRIER TAPE | WIDTH                                    | $W$    | $8.00 + 0.30 - 0.10$ | $0.315 + 0.012 - 0.004$ |
|              | THICKNESS                                | $t_1$  | $0.254 \pm 0.013$    | $0.0100 \pm 0.0005$     |
| DISTANCE     | CAVITY TO PERFORATION (WIDTH DIRECTION)  | $F$    | $3.50 \pm 0.05$      | $0.138 \pm 0.002$       |
|              | CAVITY TO PERFORATION (LENGTH DIRECTION) | $P_2$  | $2.00 \pm 0.05$      | $0.079 \pm 0.002$       |



勝特力材料 886-3-5753170  
 勝特力电子(上海) 86-21-54151736  
 勝特力电子(深圳) 86-755-83298787  
 Http://www.100y.com.tw

**Tape Dimensions and Product Orientation**  
**For Outlines SOT-323, -363**

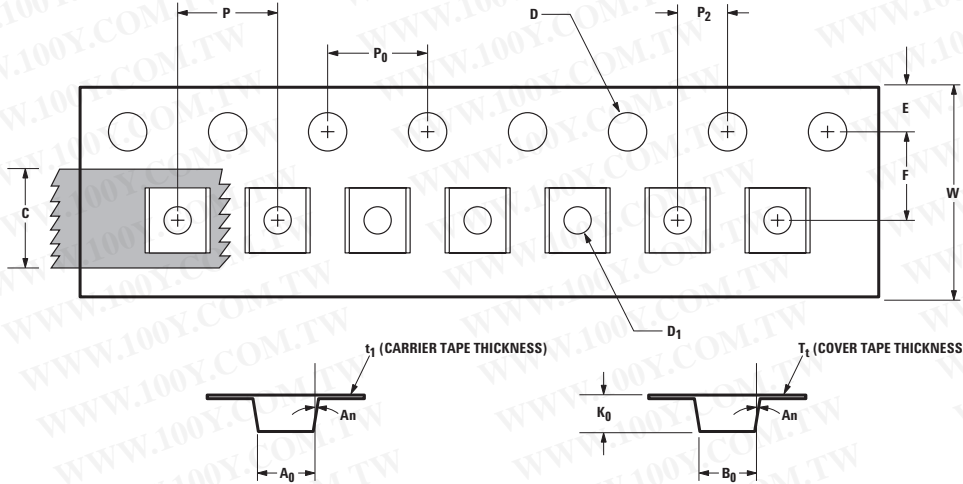

| DESCRIPTION  |  | SYMBOL         | SIZE (mm)           | SIZE (INCHES)    |
|--------------|--|----------------|---------------------|------------------|
| CAVITY       | LENGTH   | A <sub>0</sub> | 2.40 ± 0.10         | 0.094 ± 0.004    |
|              | WIDTH  | B <sub>0</sub> | 2.40 ± 0.10         | 0.094 ± 0.004    |
|              | DEPTH  | K <sub>0</sub> | 1.20 ± 0.10         | 0.047 ± 0.004    |
|              | PITCH  | P              | 4.00 ± 0.10         | 0.157 ± 0.004    |
|              | BOTTOM HOLE DIAMETER                                   | D <sub>1</sub> | 1.00 + 0.25         | 0.039 + 0.010    |
| PERFORATION  | DIAMETER   | D              | 1.55 ± 0.05         | 0.061 ± 0.002    |
|              | PITCH  | P <sub>0</sub> | 4.00 ± 0.10         | 0.157 ± 0.004    |
|              | POSITION   | E              | 1.75 ± 0.10         | 0.069 ± 0.004    |
| CARRIER TAPE | WIDTH  | W              | 8.00 ± 0.30         | 0.315 ± 0.012    |
|              | THICKNESS  | t <sub>1</sub> | 0.254 ± 0.02        | 0.0100 ± 0.0008  |
| COVER TAPE   | WIDTH  | C              | 5.4 ± 0.10          | 0.205 ± 0.004    |
|              | TAPE THICKNESS   | T <sub>1</sub> | 0.062 ± 0.001       | 0.0025 ± 0.00004 |
| DISTANCE     | CAVITY TO PERFORATION (WIDTH DIRECTION)                | F              | 3.50 ± 0.05         | 0.138 ± 0.002    |
|              | CAVITY TO PERFORATION (LENGTH DIRECTION)               | P <sub>2</sub> | 2.00 ± 0.05         | 0.079 ± 0.002    |
| ANGLE        | FOR SOT-323 (SC70-3 LEAD)<br>FOR SOT-363 (SC70-6 LEAD) | An             | 8°C MAX<br>10°C MAX |                  |

**www.agilent.com/semiconductors**

For product information and a complete list of distributors, please go to our web site.

For technical assistance call:

Americas/Canada: +1 (800) 235-0312 or (916) 788-6763

Europe: +49 (0) 6441 92460

China: 10800 650 0017

Hong Kong: (65) 6756 2394

India, Australia, New Zealand: (65) 6755 1939

Japan: (+81 3) 3335-8152(Domestic/International), or 0120-61-1280(Domestic Only)

Korea: (65) 6755 1989

Singapore, Malaysia, Vietnam, Thailand, Philippines, Indonesia: (65) 6755 2044

Taiwan: (65) 6755 1843

Data subject to change.

Copyright © 2004 Agilent Technologies, Inc.

Obsoletes 5968-7649E

March 24, 2004

5989-0475EN