

## FEATURES

- Low Power:  $I_{CC} = 300\mu\text{A}$  Typical
- Designed for RS485 or RS422 Applications
- Single 5V Supply
- -7V to 12V Bus Common Mode Range  
Permits  $\pm 7\text{V}$  Ground Difference Between Devices on the Bus
- Thermal Shutdown Protection
- Power-Up/-Down Glitch-Free Driver Outputs Permit Live Insertion or Removal of Package
- Driver Maintains High Impedance in Three-State or with the Power Off
- Combined Impedance of a Driver Output and Receiver Allows up to 32 Transceivers on the Bus
- 70mV Typical Input Hysteresis
- 28ns Typical Driver Propagation Delays with 5ns Skew for 2.5MB Operation
- Pin Compatible with the SN75180
- Available in 14-Lead PDIP and SO Packages

## APPLICATIONS

- Low Power RS485/RS422 Transceiver
- Level Translator

## DESCRIPTION

The LTC<sup>®</sup>491 is a low power differential bus/line transceiver designed for multipoint data transmission standard RS485 applications with extended common mode range (12V to -7V). It also meets the requirements of RS422.

The CMOS design offers significant power savings over its bipolar counterpart without sacrificing ruggedness against overload or ESD damage.

The driver and receiver feature three-state outputs, with the driver outputs maintaining high impedance over the entire common mode range. Excessive power dissipation caused by bus contention or faults is prevented by a thermal shutdown circuit which forces the driver outputs into a high impedance state.

The receiver has a fail safe feature which guarantees a high output state when the inputs are left open.

Both AC and DC specifications are guaranteed from 0°C to 70°C and 4.75V to 5.25V supply voltage range.

 LTC and LT are registered trademarks of Linear Technology Corporation.

## TYPICAL APPLICATION

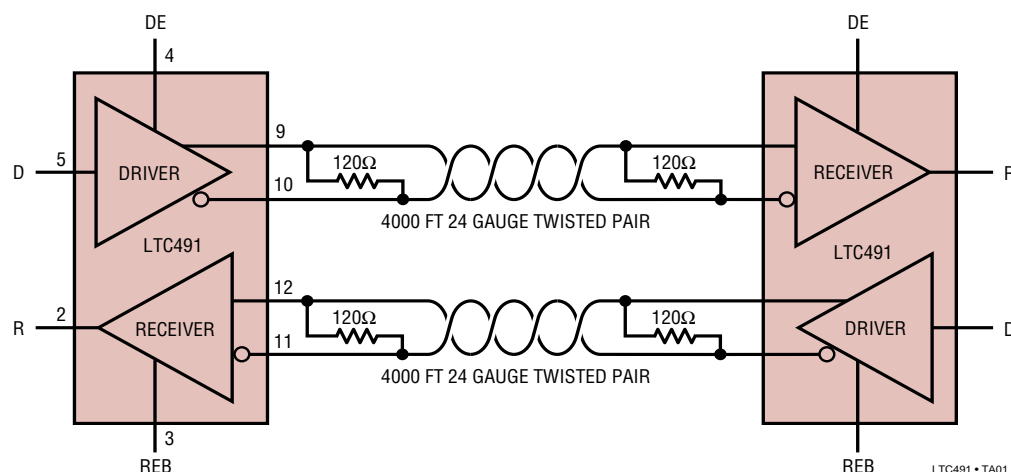

**ABSOLUTE MAXIMUM RATINGS**

(Note 1)

Supply Voltage (V <sub>CC</sub> ) .....	12V
Control Input Voltages .....	-0.5V to V <sub>CC</sub> + 0.5V
Control Input Currents .....	-50mA to 50mA
Driver Input Voltages .....	-0.5V to V <sub>CC</sub> + 0.5V
Driver Input Currents .....	-25mA to 25mA
Driver Output Voltages .....	±14V
Receiver Input Voltages .....	±14V
Receiver Output Voltages .....	-0.5V to V <sub>CC</sub> + 0.5V
Operating Temperature Range	
LTC491C .....	0°C to 70°C
LTC491I .....	-40°C to 85°C
Storage Temperature Range .....	-65°C to 150°C
Lead Temperature (Soldering, 10 sec) .....	300°C

**PACKAGE/ORDER INFORMATION**

<p>TOP VIEW</p> <p>N PACKAGE 14-LEAD PDIP      S PACKAGE 14-LEAD PLASTIC SO</p> <p>T<sub>JMAX</sub> = 100°C, θ<sub>JA</sub> = 90°C/W (N) T<sub>JMAX</sub> = 100°C, θ<sub>JA</sub> = 110°C/W (S)</p>	ORDER PART NUMBER
	<p>LTC491CN LTC491CS LTC491IN LTC491IS</p>

Consult LTC Marketing for parts specified with wider operating temperature ranges.

**DC ELECTRICAL CHARACTERISTICS** The ● denotes the specifications which apply over the full operating temperature range, otherwise specifications are at T<sub>A</sub> = 25°C. V<sub>CC</sub> = 5V ±5%

SYMBOL	PARAMETER	CONDITIONS	MIN	TYP	MAX	UNITS
V <sub>OD1</sub>	Differential Driver Output Voltage (Unloaded)	I <sub>O</sub> = 0	●		5	V
V <sub>OD2</sub>	Differential Driver Output Voltage (With load)	R = 50Ω; (RS422)	●	2		V
		R = 27Ω; (RS485) (Figure 1)	●	1.5	5	V
ΔV <sub>OD</sub>	Change in Magnitude of Driver Differential Output Voltage for Complementary Output States	R = 27Ω or R = 50Ω (Figure 1)	●		0.2	V
V <sub>OC</sub>	Driver Common Mode Output Voltage		●		3	V
Δ V <sub>OC</sub>	Change in Magnitude of Driver Common Mode Output Voltage for Complementary Output States		●		0.2	V
V <sub>IH</sub>	Input High Voltage	D, DE, REB	●	2.0		V
V <sub>IL</sub>	Input Low Voltage		●		0.8	V
I <sub>IN1</sub>	Input Current		●		±2	μA
I <sub>IN2</sub>	Input Current (A, B)	V <sub>CC</sub> = 0V or 5.25V	●		1.0	mA
		V <sub>IN</sub> = 12V V <sub>IN</sub> = -7V	●		-0.8	mA
V <sub>TH</sub>	Differential Input Threshold Voltage for Receiver	-7V ≤ V <sub>CM</sub> ≤ 12V	●	-0.2	0.2	V
ΔV <sub>TH</sub>	Receiver Input Hysteresis	V <sub>CM</sub> = 0V	●	70		mV
V <sub>OH</sub>	Receiver Output High Voltage	I <sub>O</sub> = -4mA, V <sub>ID</sub> = 0.2V	●	3.5		V
V <sub>OL</sub>	Receiver Output Low Voltage	I <sub>O</sub> = 4mA, V <sub>ID</sub> = -0.2V	●		0.4	V
I <sub>OZR</sub>	Three-State Output Current at Receiver	V <sub>CC</sub> = Max 0.4V ≤ V <sub>O</sub> ≤ 2.4V	●		±1	μA
I <sub>CC</sub>	Supply Current	No Load; D = GND, or V <sub>CC</sub>	●	300	500	μA
		Outputs Enabled	●	300	500	μA
R <sub>IN</sub>	Receiver Input Resistance		●	12		kΩ
			●			
I <sub>OSD1</sub>	Driver Short Circuit Current, V <sub>OUT</sub> = High	V <sub>O</sub> = -7V	●	100	250	mA
I <sub>OSD2</sub>	Driver Short Circuit Current, V <sub>OUT</sub> = Low	V <sub>O</sub> = 12V	●	100	250	mA
I <sub>OSR</sub>	Receiver Short Circuit Current	0V ≤ V <sub>O</sub> ≤ V <sub>CC</sub>	●	7	85	mA
I <sub>OZ</sub>	Driver Three-State Output Current	V <sub>O</sub> = -7V to 12V	●	±2	±200	μA

## SWITCHING CHARACTERISTICS

The ● denotes the specifications which apply over the full operating temperature range, otherwise specifications are at  $T_A = 25^\circ\text{C}$ .  $V_{CC} = 5V \pm 5\%$

SYMBOL	PARAMETER	CONDITIONS		MIN	TYP	MAX	UNITS
$t_{PLH}$	Driver Input to Output	$R_{DIFF} = 54\Omega$ , $C_{L1} = C_{L2} = 100\text{pF}$ (Figures 2, 5)	●	10	30	50	ns
$t_{PHL}$	Driver Input to Output		●	10	30	50	ns
$t_{SKEW}$ $t_r$ , $t_f$	Driver Output to Output Driver Rise or Fall Time		● ●	5	5 15	25	ns ns
$t_{ZH}$	Driver Enable to Output High	$C_L = 100\text{pF}$ (Figures 4, 6) S2 Closed	●		40	70	ns
$t_{ZL}$	Driver Enable to Output Low	$C_L = 100\text{pF}$ (Figures 4, 6) S1 Closed	●		40	70	ns
$t_{LZ}$	Driver Disable Time From Low	$C_L = 15\text{pF}$ (Figures 4, 6) S1 Closed	●		40	70	ns
$t_{HZ}$	Driver Disable Time From High	$C_L = 15\text{pF}$ (Figures 4, 6) S2 Closed	●		40	70	ns
$t_{PLH}$	Receiver Input to Output	$R_{DIFF} = 54\Omega$ , $C_{L1} = C_{L2} = 100\text{pF}$ (Figures 2, 7)	●	40	70	150	ns
$t_{PHL}$	Receiver Input to Output		●	40	70	150	ns
$t_{SKD}$	$ t_{PLH} - t_{PHL} $ Differential Receiver Skew		●		13		ns
$t_{ZL}$	Receiver Enable to Output Low	$C_L = 15\text{pF}$ (Figures 3, 8) S1 Closed	●		20	50	ns
$t_{ZH}$	Receiver Enable to Output High	$C_L = 15\text{pF}$ (Figures 3, 8) S2 Closed	●		20	50	ns
$t_{LZ}$	Receiver Disable From Low	$C_L = 15\text{pF}$ (Figures 3, 8) S1 Closed	●		20	50	ns
$t_{HZ}$	Receiver Disable From High	$C_L = 15\text{pF}$ (Figures 3, 8) S2 Closed	●		20	50	ns

**Note 1:** Absolute Maximum Ratings are those values beyond which the life of the device may be impaired.

**Note 2:** All currents into device pins are positive; all currents out of device pins are negative. All voltages are referenced to device ground unless otherwise specified.

**Note 3:** All typicals are given for  $V_{CC} = 5V$  and temperature =  $25^\circ\text{C}$ .

## PIN FUNCTIONS

**NC (Pin 1):** Not Connected.

**R (Pin 2):** Receiver Output. If the receiver output is enabled (REB low), then if  $A > B$  by 200mV, R will be high. If  $A < B$  by 200mV, then R will be low.

**REB (Pin 3):** Receiver Output Enable. A low enables the receiver output, R. A high input forces the receiver output into a high impedance state.

**DE (Pin 4):** Driver Output Enable. A high on DE enables the driver outputs, Y and Z. A low input forces the driver outputs into a high impedance state.

**D (Pin 5):** Driver Input. If the driver outputs are enabled (DE high), then a low on D forces the driver outputs Y low and Z high. A high on D will force Y high and Z low.

**GND (Pin 6):** Ground Connection.

**GND (Pin 7):** Ground Connection.

**NC (Pin 8):** Not Connected.

**Y (Pin 9):** Driver Output.

**Z (Pin 10):** Driver Output.

**B (Pin 11):** Receiver Input.

**A (Pin 12):** Receiver Input.

**NC (Pin 13):** Not Connected.

**$V_{CC}$  (Pin 14):** Positive Supply;  $4.75V \leq V_{CC} \leq 5.25V$ .

# TYPICAL PERFORMANCE CHARACTERISTICS

**Driver Output High Voltage vs Output Current,  $T_A = 25^\circ\text{C}$**

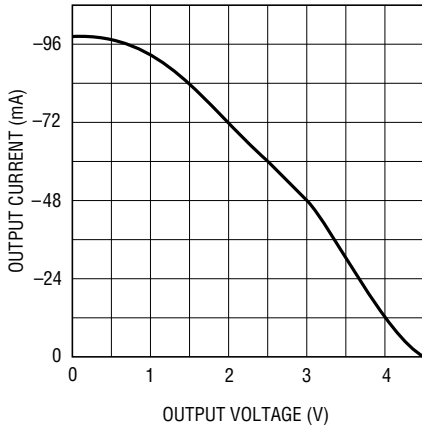

LTC491 • TPC01

**Driver Differential Output Voltage vs Output Current,  $T_A = 25^\circ\text{C}$**

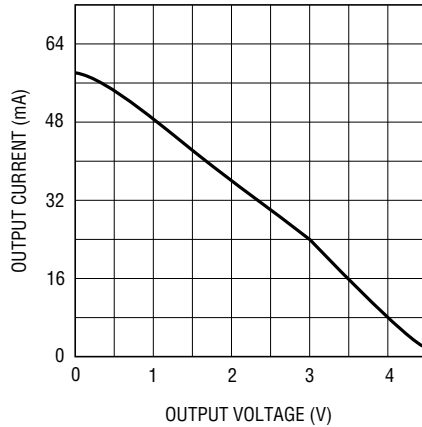

LTC491 • TPC02

**Driver Output Low Voltage vs Output Current,  $T_A = 25^\circ\text{C}$**

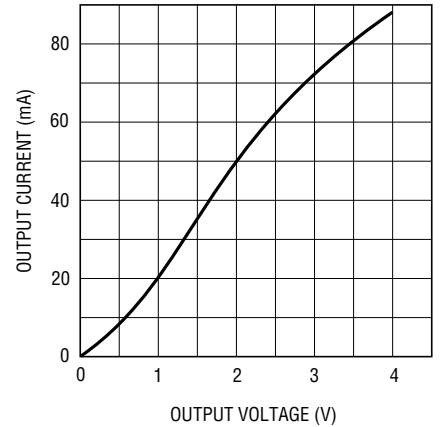

LTC491 • TPC03

**TTL Input Threshold vs Temperature**

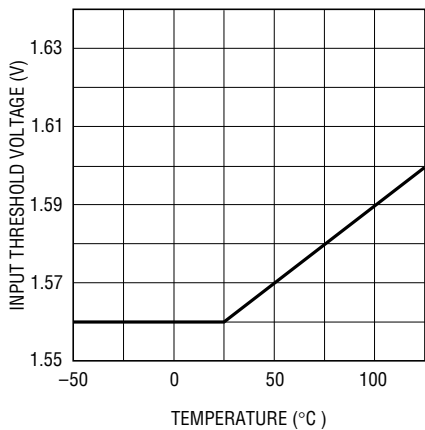

LTC491 • TPC04

**Driver Skew vs Temperature**

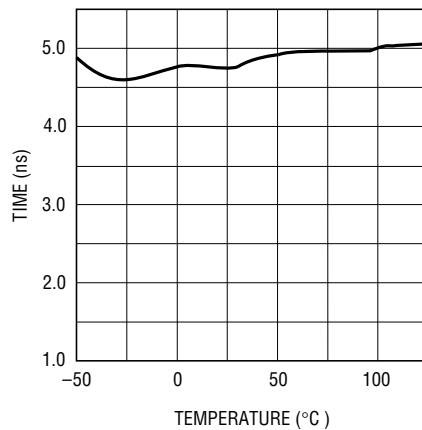

LTC491 • TPC05

**Supply Current vs Temperature**

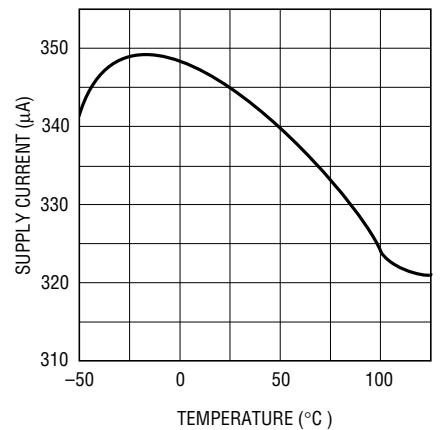

LTC491 • TPC06

**Driver Differential Output Voltage vs Temperature,  $R_0 = 54\Omega$**

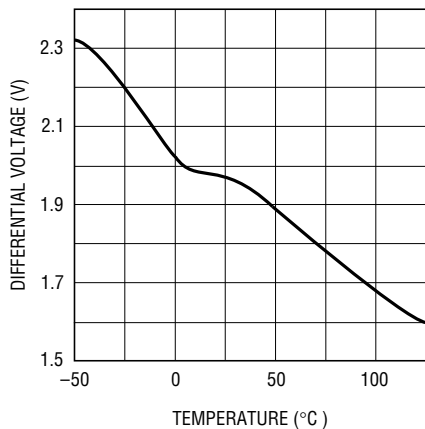

LTC491 • TPC07

**Receiver  $|t_{PLH} t_{PHL}|$  vs Temperature**

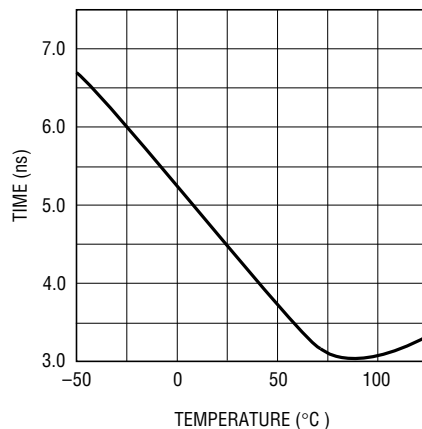

LTC491 • TPC08

**Receiver Output Low Voltage vs Temperature at  $I = 8\text{mA}$**

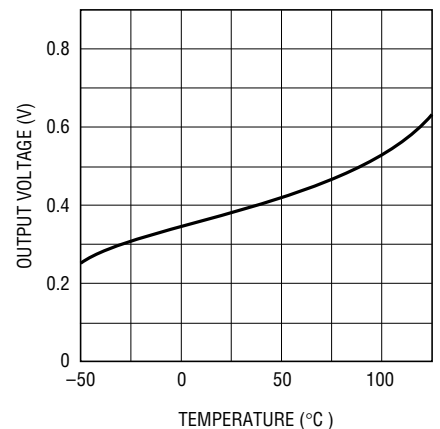

LTC491 • TPC09

TEST CIRCUITS

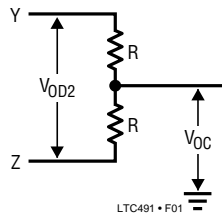

Figure 1. Driver DC Test Load

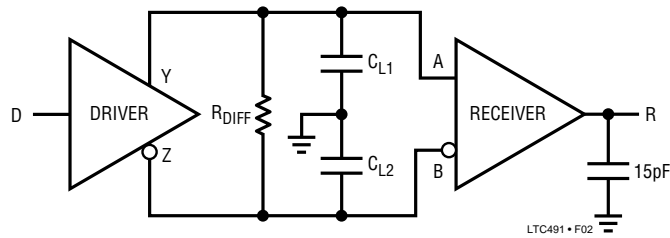

Figure 2. Driver/Receiver Timing Test Circuit

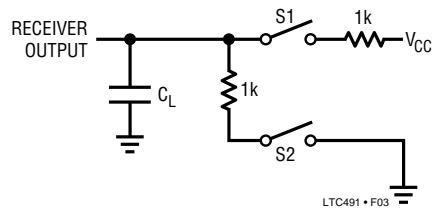

Figure 3. Receiver Timing Test Load

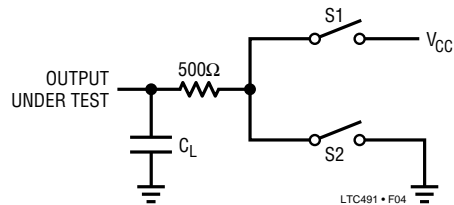

Figure 4. Driver Timing Test Load

# SWITCHING TIME WAVEFORMS

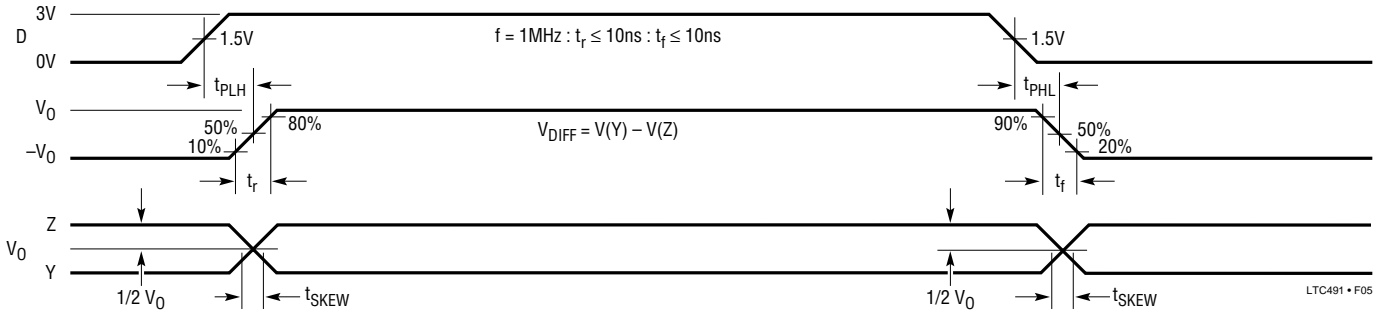

Figure 5. Driver Propagation Delays

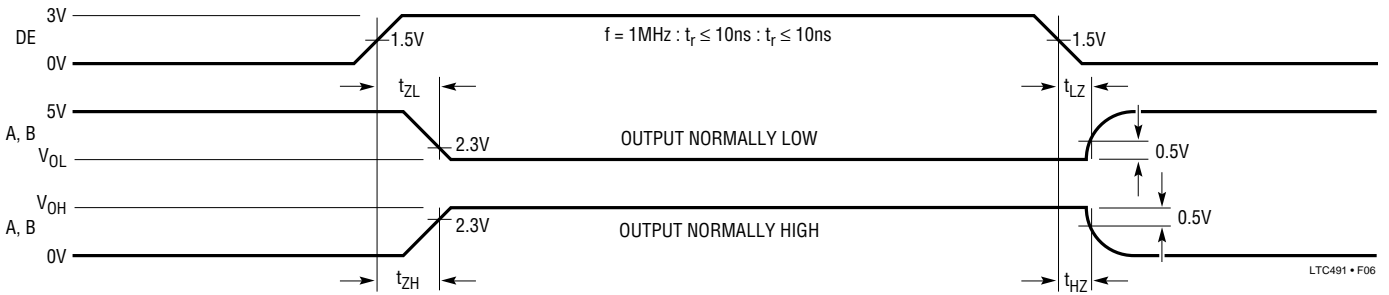

Figure 6. Driver Enable and Disable Times

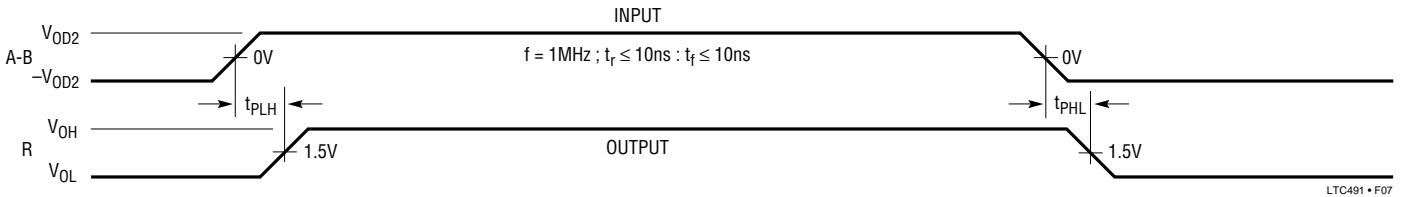

Figure 7. Receiver Propagation Delays

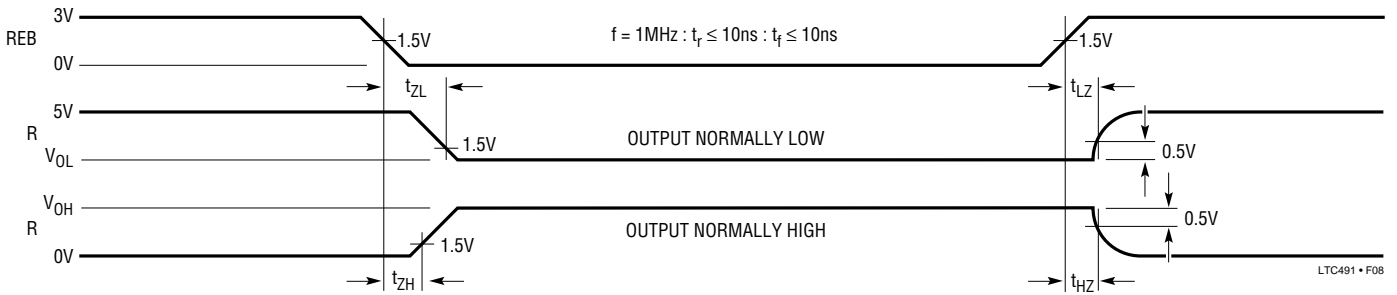

Figure 8. Receiver Enable and Disable Times

## APPLICATIONS INFORMATION

### Typical Application

A typical connection of the LTC491 is shown in Figure 9. Two twisted-pair wires connect up to 32 driver/receiver pairs for full duplex data transmission. There are no restrictions on where the chips are connected to the wires, and it isn't necessary to have the chips connected at the ends. However, the wires must be terminated only at the ends with a resistor equal to their characteristic impedance, typically  $120\Omega$ . The input impedance of a receiver is typically  $20k\Omega$  to GND, or 0.6 unit RS-485 load, so in practice 50 to 60 transceivers can be connected to the same wires. The optional shields around the twisted pair help reduce unwanted noise, and are connected to GND at one end.

The LTC491 can also be used as a line repeater as shown in Figure 10. If the cable length is longer than 4000 feet, the LTC491 is inserted in the middle of the cable with the receiver output connected back to the driver input.

### Thermal Shutdown

The LTC491 has a thermal shutdown feature which protects the part from excessive power dissipation. If the

outputs of the driver are accidentally shorted to a power supply or low impedance source, up to 250mA can flow through the part. The thermal shutdown circuit disables the driver outputs when the internal temperature reaches  $150^\circ\text{C}$  and turns them back on when the temperature cools to  $130^\circ\text{C}$ . If the outputs of two or more LTC491 drivers are shorted directly, the driver outputs can not supply enough current to activate the thermal shutdown. Thus, the thermal shutdown circuit will not prevent contention faults when two drivers are active on the bus at the same time.

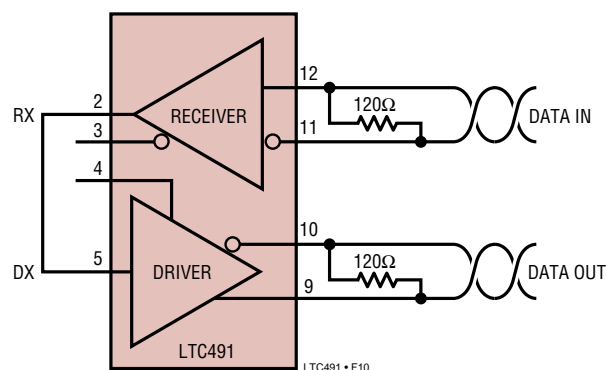

Figure 10. Line Repeater

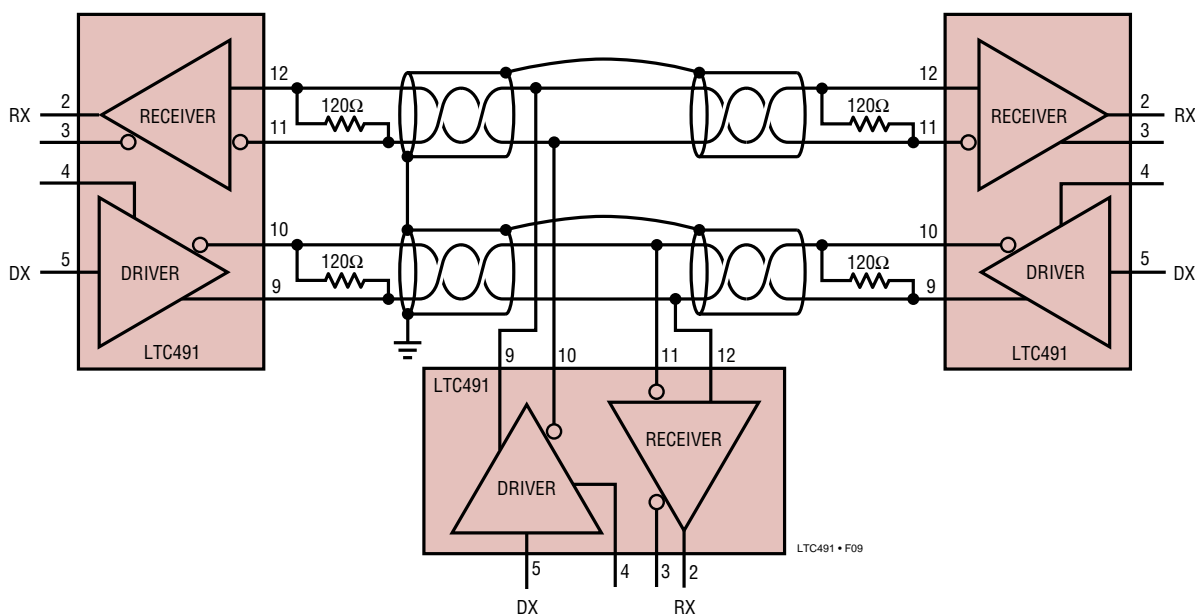

Figure 9. Typical Connection

## APPLICATIONS INFORMATION

### Cables and Data Rate

The transmission line of choice for RS485 applications is a twisted pair. There are coaxial cables (twinaxial) made for this purpose that contain straight pairs, but these are less flexible, more bulky, and more costly than twisted pairs. Many cable manufacturers offer a broad range of 120Ω cables designed for RS485 applications.

Losses in a transmission line are a complex combination of DC conductor loss, AC losses (skin effect), leakage and AC losses in the dielectric. In good polyethylene cables such as the Belden 9841, the conductor losses and dielectric losses are of the same order of magnitude, leading to relatively low over all loss (Figure 11).

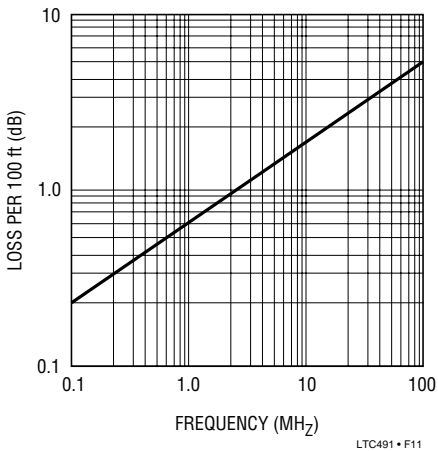

Figure 11. Attenuation vs Frequency for Belden 9481

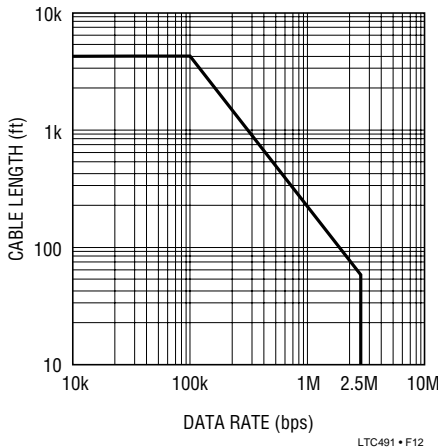

Figure 12. Cable Length vs Data Rate

When using low loss cables, Figure 12 can be used as a guideline for choosing the maximum line length for a given data rate. With lower quality PVC cables, the dielectric loss factor can be 1000 times worse. PVC twisted pairs have terrible losses at high data rates (>100kBs), and greatly reduce the maximum cable length. At low data rates however, they are acceptable and much more economical.

### Cable Termination

The proper termination of the cable is very important. If the cable is not terminated with its characteristic impedance, distorted waveforms will result. In severe cases, distorted (false) data and nulls will occur. A quick look at the output of the driver will tell how well the cable is terminated. It is best to look at a driver connected to the end of the cable, since this eliminates the possibility of getting reflections from two directions. Simply look at the driver output while transmitting square wave data. If the cable is terminated properly, the waveform will look like a square wave (Figure 13).

If the cable is loaded excessively (47Ω), the signal initially sees the surge impedance of the cable and jumps to an initial amplitude. The signal travels down the cable and is reflected back out of phase because of the mistermi-

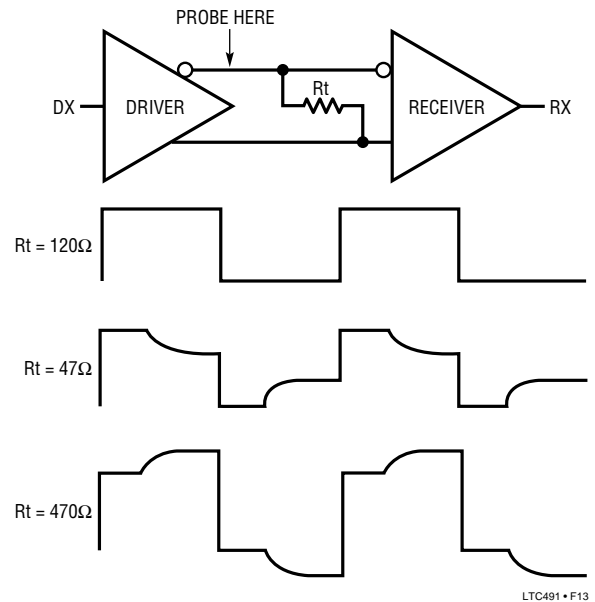

Figure 13. Termination Effects



## APPLICATIONS INFORMATION

When the reflected signal returns to the driver, the amplitude will be lowered. The width of the pedestal is equal to twice the electrical length of the cable (about 1.5ns/foot). If the cable is lightly loaded ( $470\Omega$ ), the signal reflects in phase and increases the amplitude at the driver output. An input frequency of 30kHz is adequate for tests out to 4000 feet of cable.

### AC Cable Termination

Cable termination resistors are necessary to prevent unwanted reflections, but they consume power. The typical differential output voltage of the driver is 2V when the cable is terminated with two  $120\Omega$  resistors, causing 33mA of DC current to flow in the cable when no data is being sent. This DC current is about 60 times greater than the supply current of the LTC491. One way to eliminate the unwanted current is by AC coupling the termination resistors as shown in Figure 14.

The coupling capacitor must allow high-frequency energy to flow to the termination, but block DC and low frequencies. The dividing line between high and low frequency depends on the length of the cable. The coupling capacitor must pass frequencies above the point where the line represents an electrical one-tenth wavelength. The value of the coupling capacitor should therefore be set at 16.3pF per foot of cable length for  $120\Omega$  cables. With the coupling capacitors in place, power is consumed only on the signal edges, and not when the driver output is idling at a 1 or 0 state. A 100nF capacitor is adequate for lines up to 4000 feet in length. Be aware that the power savings start to decrease once the data rate surpasses  $1/(120\Omega \times C)$ .

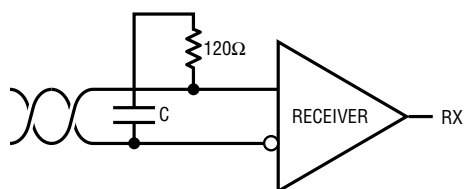

$$C = \text{LINE LENGTH (ft)} \times 16.3\text{pF}$$

LTC491 • F14

Figure 14. AC Coupled Termination

### Receiver Open-Circuit Fail-Safe

Some data encoding schemes require that the output of the receiver maintains a known state (usually a logic 1) when the data is finished transmitting and all drivers on the line are forced into three-state. The receiver of the LTC491 has a fail-safe feature which guarantees the output to be in a logic 1 state when the receiver inputs are left floating (open-circuit). However, when the cable is terminated with  $120\Omega$ , the differential inputs to the receiver are shorted together, not left floating. Because the receiver has about 70mV of hysteresis, the receiver output will tend to maintain the last data bit received, but this is not guaranteed.

The termination resistors are used to generate a DC bias which forces the receiver output to a known state; in the case of Figure 15, a logic 0. The first method consumes about 208mW and the second about 8mW. The lowest power solution is to use an AC termination with a pull-up resistor. Simply swap the receiver inputs for data protocols ending in logic 1.

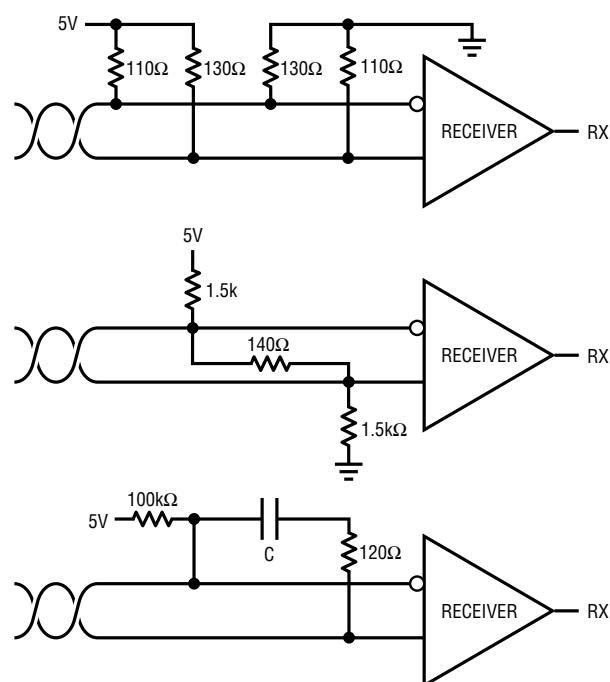

LTC491 • F15

Figure 15. Forcing "0" When All Drivers are Off

## APPLICATIONS INFORMATION

### Fault Protection

All of LTC's RS485 products are protected against ESD transients up to 2kV using the human body model (100pF, 1.5kΩ). However, some applications need more protection. The best protection method is to connect a bidirectional TransZorb® from each line side pin to ground (Figure 16).

A TransZorb is a silicon transient voltage suppressor that has exceptional surge handling capabilities, fast response time, and low series resistance. They are available from General Semiconductor Industries and come in a variety of breakdown voltages and prices. Be sure to pick a breakdown voltage higher than the common mode voltage

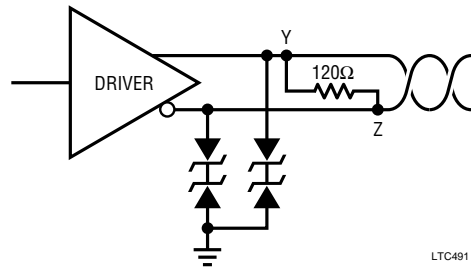

LTC491 • F16

Figure 16. ESD Protection with TransZorbs

required for your application (typically 12V). Also, don't forget to check how much the added parasitic capacitance will load down the bus.

TransZorb is a registered trademark of General Instruments, GSI

## PACKAGE DESCRIPTION

### N Package 14-Lead PDIP (Narrow .300 Inch) (Reference LTC DWG # 05-08-1510)

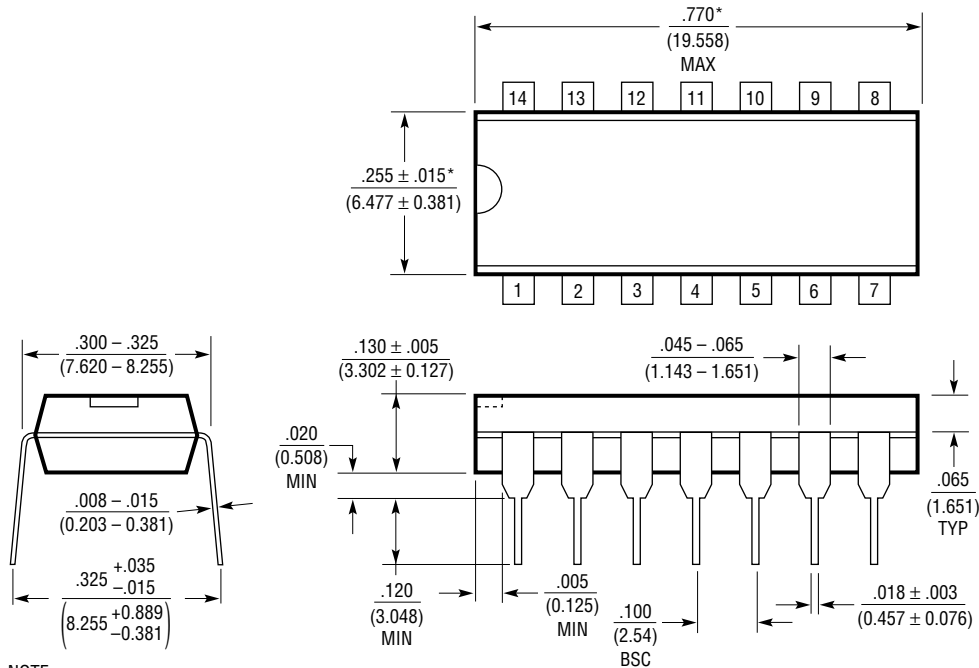

NOTE:  
1. DIMENSIONS ARE  $\frac{\text{INCHES}}{\text{MILLIMETERS}}$   
\*THESE DIMENSIONS DO NOT INCLUDE MOLD FLASH OR PROTRUSIONS.  
MOLD FLASH OR PROTRUSIONS SHALL NOT EXCEED .010 INCH (0.254mm)

N14 1002

## PACKAGE DESCRIPTION

### S Package 14-Lead Plastic Small Outline (Narrow .150 Inch) (Reference LTC DWG # 05-08-1610)

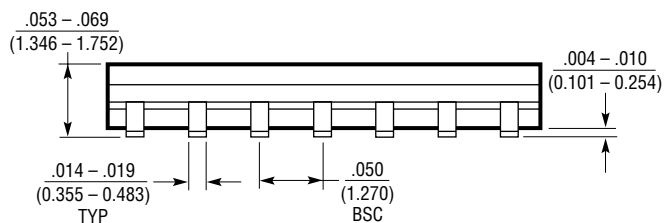
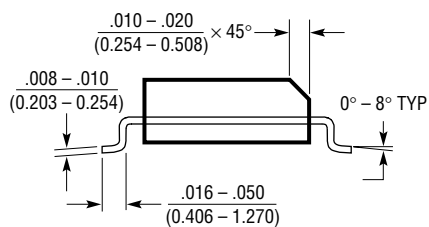
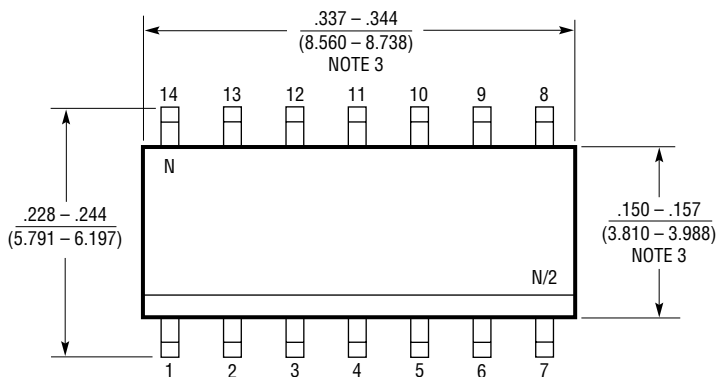
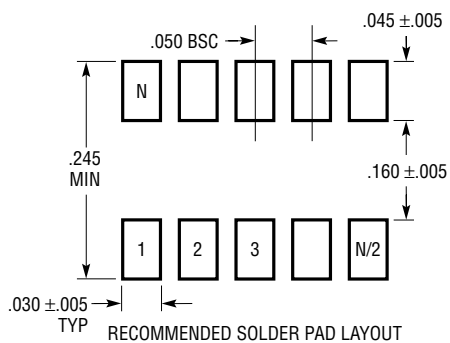

- NOTE:
1. DIMENSIONS IN  $\frac{\text{INCHES}}{\text{MILLIMETERS}}$
  2. DRAWING NOT TO SCALE
  3. THESE DIMENSIONS DO NOT INCLUDE MOLD FLASH OR PROTRUSIONS.  
MOLD FLASH OR PROTRUSIONS SHALL NOT EXCEED .006" (0.15mm)

S14 0502

## TYPICAL APPLICATIONS

### RS232 Receiver

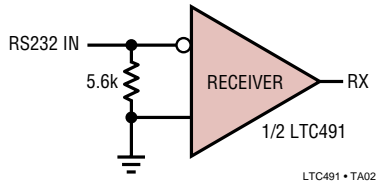

### RS232 to RS485 Level Transistor with Hysteresis

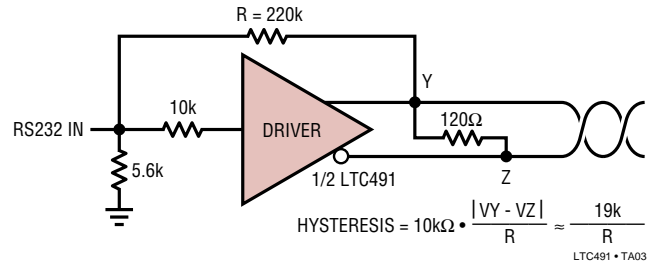

## RELATED PARTS

PART NUMBER	DESCRIPTION	COMMENTS
LTC486/LTC487	Low Power Quad RS485 Drivers	110μA Supply Current
LTC488/LTC489	Low Power Quad RS485 Receivers	7mA Supply Current
LTC1480	3.3V Supply RS485 Transceiver	Lower Supply Voltage
LTC1481	Low Power RS485 Transceiver with Shutdown	Lowest Power
LTC1482	RS485 Transceiver with Carrier Detect	±15kV ESD, Fail-Safe
LTC1483	Low Power, Low EMI RS485 Transceiver	Slew Rate Limited Driver Outputs, Lowest Power
LTC1484	RS485 Transceiver with Fail-Safe	±15kV ESD, MSOP Package
LTC1485	10Mbps RS485 Transceiver	High Speed
LTC1518/LTC1519	52Mbps Quad RS485 Receivers	Higher Speed, LTC488/LTC489 Pin-Compatible
LTC1520	LVDS-Compatible Quad Receiver	100mV Threshold, Low Channel-to-Channel Skew
LTC1535	2500V Isolated RS485 Transceiver	Full-Duplex, Self-Powered Using External Transformer
LTC1685	52Mbps RS485 Transceiver	Industry-Standard Pinout, 500ps Propagation Delay Skew
LTC1686/LTC1687	52Mbps Full-Duplex RS485 Transceiver	LTC490/LTC491 Pin Compatible
LTC1688/LTC1689	100Mbps Quad RS485 Drivers	Highest Speed, LTC486/LTC487 Pin Compatible
LTC1690	Full-Duplex RS485 Transceiver with Fail-Safe	±15kV ESD, LTC490 Pin Compatible
LT1785/LTC1785A	±60V Protected RS485 Transceivers	±15kV ESD, Fail-Safe (LT1785A)
LT1791/LTC1791A	±60V Protected Full-Duplex RS485 Transceivers	±15kV ESD, Fail-Safe (LT1791A), LTC491 Pin Compatible