

# MMBT6427LT1G, SMMBT6427LT1G

## Darlington Transistor

### NPN Silicon

#### Features

- S Prefix for Automotive and Other Applications Requiring Unique Site and Control Change Requirements; AEC-Q101 Qualified and PPAP Capable
- These Devices are Pb-Free, Halogen Free/BFR Free and are RoHS Compliant

#### MAXIMUM RATINGS

Rating	Symbol	Value	Unit
Collector - Emitter Voltage	$V_{CEO}$	40	Vdc
Collector - Base Voltage	$V_{CBO}$	40	Vdc
Emitter - Base Voltage	$V_{EBO}$	12	Vdc
Collector Current - Continuous	$I_C$	500	mAdc

#### THERMAL CHARACTERISTICS

Characteristic	Symbol	Max	Unit
Total Device Dissipation FR-5 Board, (Note 1) $T_A = 25^\circ\text{C}$ Derate above $25^\circ\text{C}$	$P_D$	225 1.8	mW mW/ $^\circ\text{C}$
Thermal Resistance, Junction-to-Ambient	$R_{\theta JA}$	556	$^\circ\text{C}/\text{W}$
Total Device Dissipation Alumina Substrate, (Note 2) $T_A = 25^\circ\text{C}$ Derate above $25^\circ\text{C}$	$P_D$	300 2.4	mW mW/ $^\circ\text{C}$
Thermal Resistance, Junction-to-Ambient	$R_{\theta JA}$	417	$^\circ\text{C}/\text{W}$
Junction and Storage Temperature	$T_J, T_{stg}$	-55 to +150	$^\circ\text{C}$

Stresses exceeding those listed in the Maximum Ratings table may damage the device. If any of these limits are exceeded, device functionality should not be assumed, damage may occur and reliability may be affected.

1. FR-5 =  $1.0 \times 0.75 \times 0.062$  in.
2. Alumina =  $0.4 \times 0.3 \times 0.024$  in. 99.5% alumina.



ON Semiconductor®

[www.onsemi.com](http://www.onsemi.com)

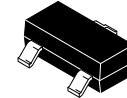

SOT-23 (TO-236)  
CASE 318  
STYLE 6

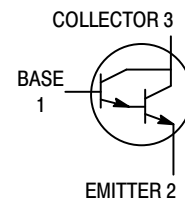

#### MARKING DIAGRAM

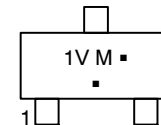

1V = Device Code  
M = Date Code\*  
▪ = Pb-Free Package

(Note: Microdot may be in either location)

\*Date Code orientation and/or overbar may vary depending upon manufacturing location.

#### ORDERING INFORMATION

Device	Package	Shipping†
MMBT6427LT1G	SOT-23 (Pb-Free)	3,000 Tape & Reel
SMMBT6427LT1G	SOT-23 (Pb-Free)	3,000 Tape & Reel

†For information on tape and reel specifications, including part orientation and tape sizes, please refer to our Tape and Reel Packaging Specifications Brochure, BRD8011/D.

# MMBT6427LT1G, SMMBT6427LT1G

## ELECTRICAL CHARACTERISTICS ( $T_A = 25^\circ\text{C}$ unless otherwise noted)

Characteristic	Symbol	Min	Max	Unit
<b>OFF CHARACTERISTICS</b>				
Collector – Emitter Breakdown Voltage ( $I_C = 10\text{ mAdc}$ , $V_{BE} = 0$ )	$V_{(BR)CEO}$	40	–	Vdc
Collector – Base Breakdown Voltage ( $I_C = 100\text{ }\mu\text{Adc}$ , $I_E = 0$ )	$V_{(BR)CBO}$	40	–	Vdc
Emitter – Base Breakdown Voltage ( $I_C = 10\text{ }\mu\text{Adc}$ , $I_C = 0$ )	$V_{(BR)EBO}$	12	–	Vdc
Collector Cutoff Current ( $V_{CE} = 25\text{ Vdc}$ , $I_B = 0$ )	$I_{CES}$	–	1.0	$\mu\text{Adc}$
Collector Cutoff Current ( $V_{CB} = 30\text{ Vdc}$ , $I_E = 0$ )	$I_{CBO}$	–	50	nAdc
Emitter Cutoff Current ( $V_{EB} = 10\text{ Vdc}$ , $I_C = 0$ )	$I_{EBO}$	–	50	nAdc
<b>ON CHARACTERISTICS</b>				
DC Current Gain ( $I_C = 10\text{ mAdc}$ , $V_{CE} = 5.0\text{ Vdc}$ ) ( $I_C = 100\text{ mAdc}$ , $V_{CE} = 5.0\text{ Vdc}$ ) ( $I_C = 500\text{ mAdc}$ , $V_{CE} = 5.0\text{ Vdc}$ )	$h_{FE}$	10,000 20,000 14,000	100,000 200,000 140,000	–
Collector – Emitter Saturation Voltage ( $I_C = 50\text{ mAdc}$ , $I_B = 0.5\text{ mAdc}$ ) ( $I_C = 500\text{ mAdc}$ , $I_B = 0.5\text{ mAdc}$ )	$V_{CE(sat)}^{(3)}$	– –	1.2 1.5	Vdc
Base – Emitter Saturation Voltage ( $I_C = 500\text{ mAdc}$ , $I_B = 0.5\text{ mAdc}$ )	$V_{BE(sat)}$	–	2.0	Vdc
Base – Emitter On Voltage ( $I_C = 50\text{ mAdc}$ , $V_{CE} = 5.0\text{ Vdc}$ )	$V_{BE(on)}$	–	1.75	Vdc
<b>SMALL-SIGNAL CHARACTERISTICS</b>				
Output Capacitance ( $V_{CB} = 10\text{ Vdc}$ , $I_E = 0$ , $f = 1.0\text{ MHz}$ )	$C_{obo}$	–	7.0	pF
Input Capacitance ( $V_{EB} = 0.5\text{ Vdc}$ , $I_C = 0$ , $f = 1.0\text{ MHz}$ )	$C_{ibo}$	–	15	pF
Current Gain – High Frequency ( $I_C = 10\text{ mAdc}$ , $V_{CE} = 5.0\text{ Vdc}$ , $f = 100\text{ MHz}$ )	$ h_{fe} $	1.3	–	Vdc
Noise Figure ( $I_C = 1.0\text{ mAdc}$ , $V_{CE} = 5.0\text{ Vdc}$ , $R_S = 100\text{ k}\Omega$ , $f = 1.0\text{ kHz}$ )	NF	–	10	dB

Product parametric performance is indicated in the Electrical Characteristics for the listed test conditions, unless otherwise noted. Product performance may not be indicated by the Electrical Characteristics if operated under different conditions.

3. Pulse Test: Pulse Width = 300  $\mu\text{s}$ , Duty Cycle = 2.0%.

# MMBT6427LT1G, SMMBT6427LT1G

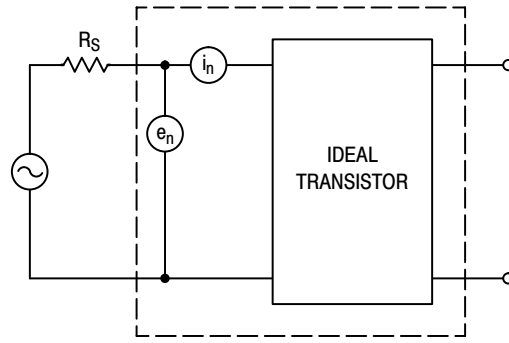

Figure 1. Transistor Noise Model

## NOISE CHARACTERISTICS

( $V_{CE} = 5.0 \text{ Vdc}$ ,  $T_A = 25^\circ\text{C}$ )

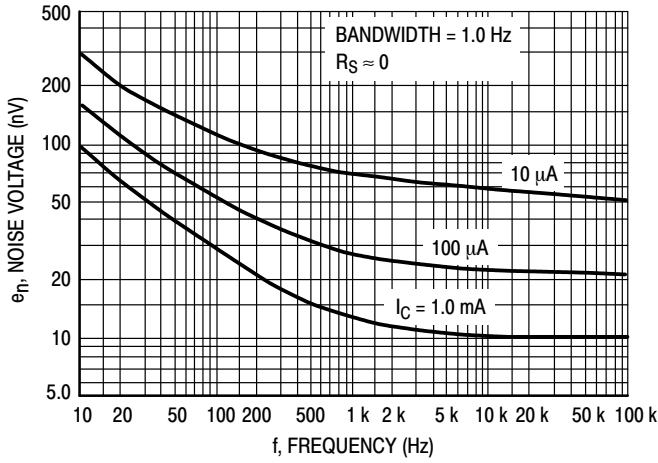

Figure 2. Noise Voltage

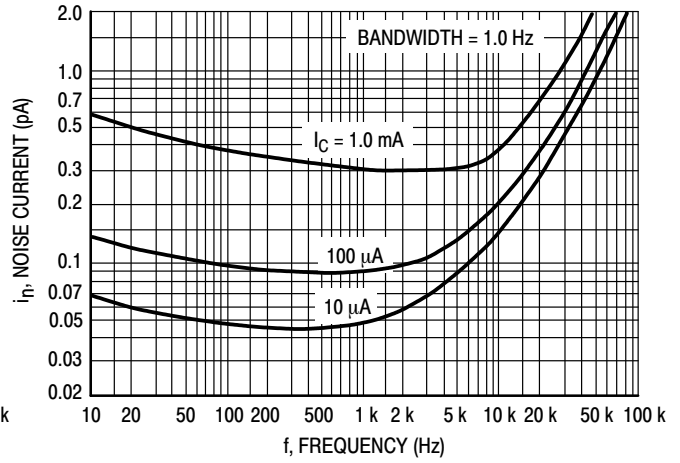

Figure 3. Noise Current

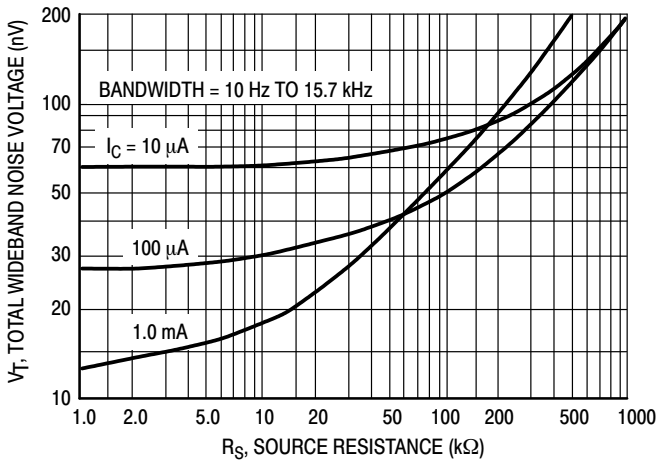

Figure 4. Total Wideband Noise Voltage

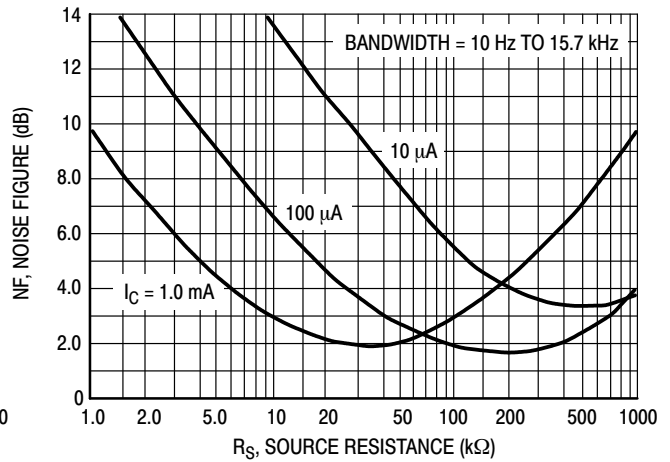

Figure 5. Wideband Noise Figure

# MMBT6427LT1G, SMMBT6427LT1G

## SMALL-SIGNAL CHARACTERISTICS

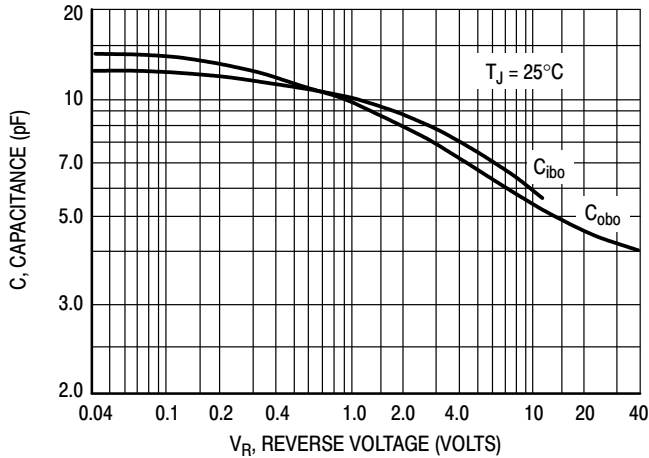

Figure 6. Capacitance

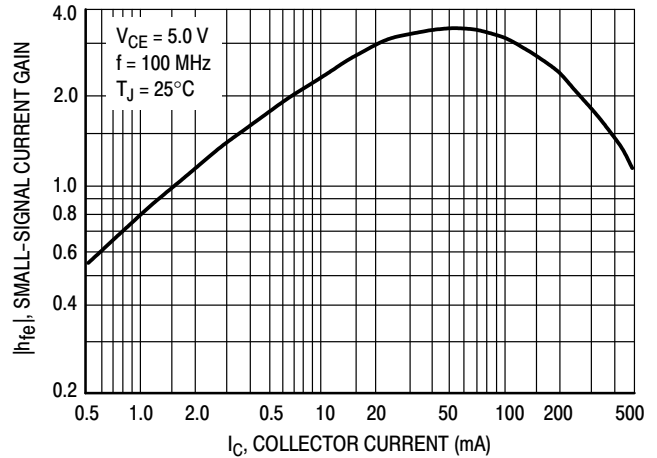

Figure 7. High Frequency Current Gain

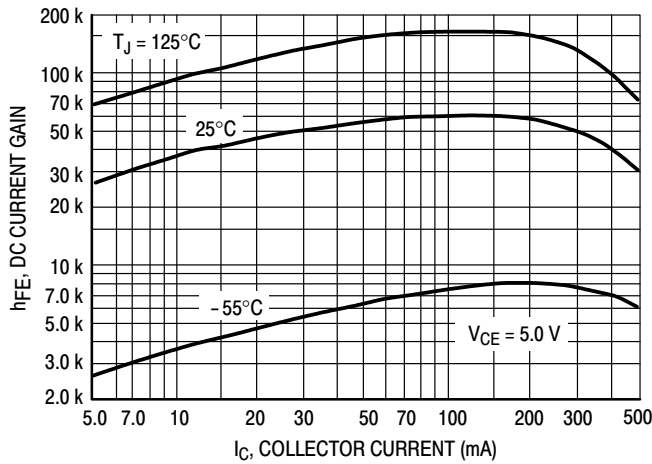

Figure 8. DC Current Gain

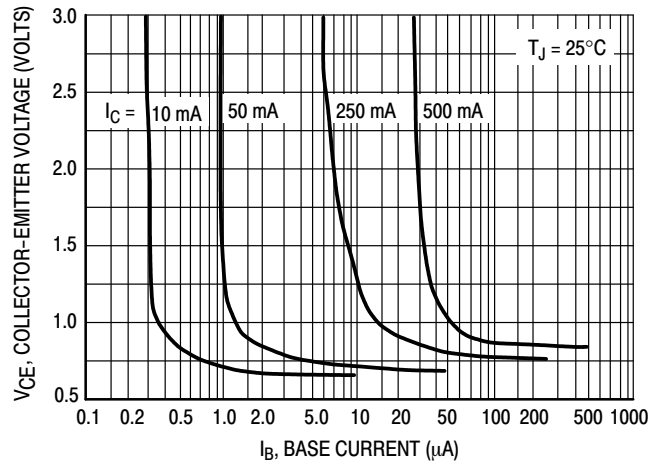

Figure 9. Collector Saturation Region

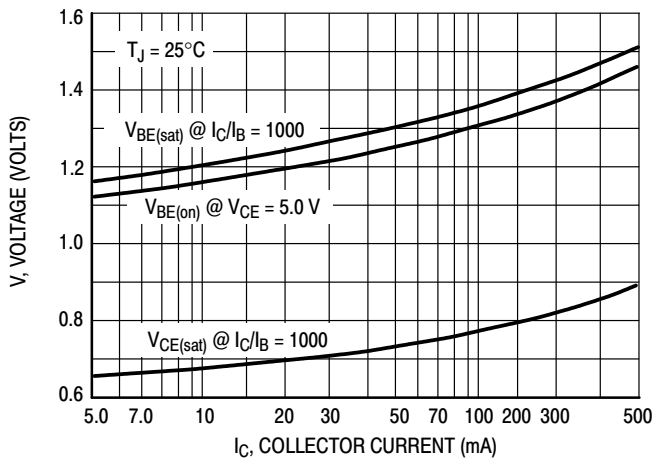

Figure 10. "On" Voltages

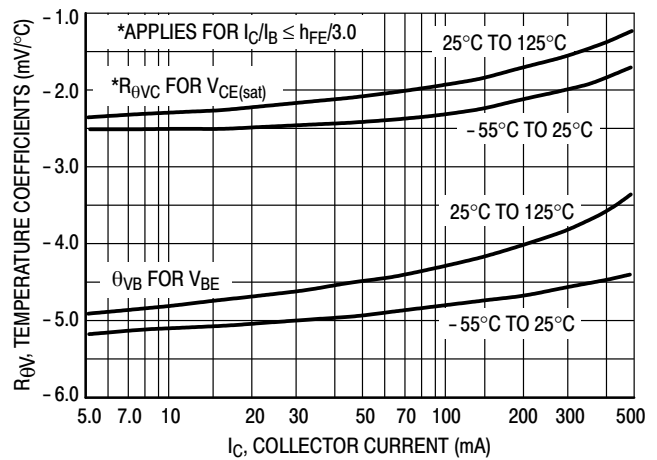

Figure 11. Temperature Coefficients

# MMBT6427LT1G, SMMBT6427LT1G

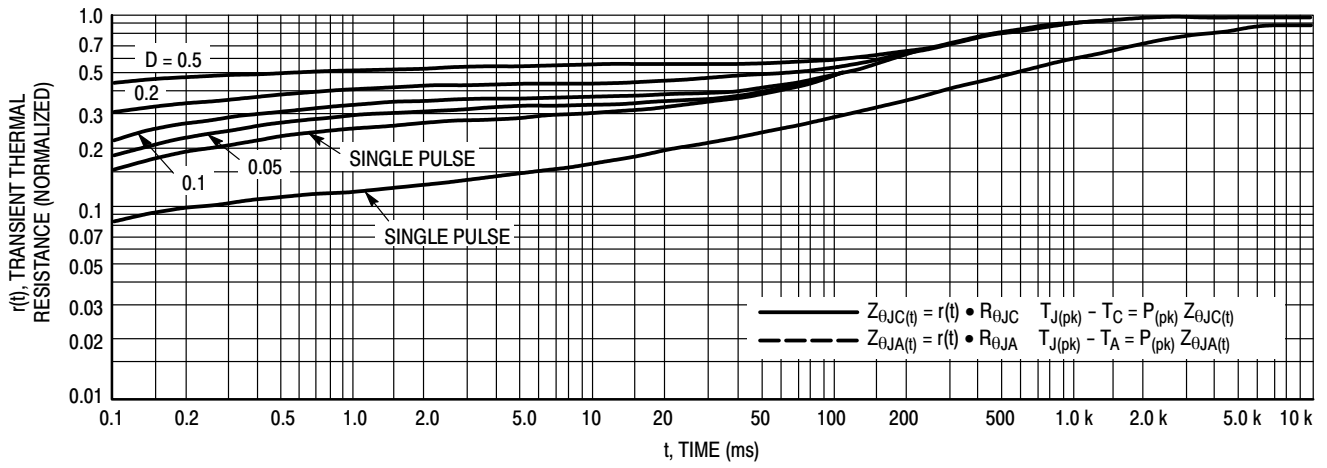
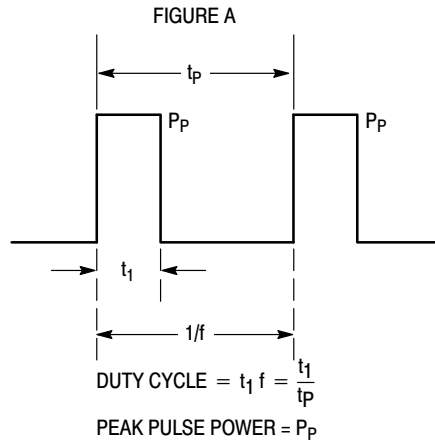

Figure 12. Thermal Response



**Design Note: Use of Transient Thermal Resistance Data**

# MECHANICAL CASE OUTLINE

## PACKAGE DIMENSIONS

ON Semiconductor®



**SOT-23 (TO-236)**  
CASE 318-08  
ISSUE AS

DATE 30 JAN 2018

SCALE 4:1



**NOTES:**

1. DIMENSIONING AND TOLERANCING PER ASME Y14.5M, 1994.
2. CONTROLLING DIMENSION: MILLIMETERS.
3. MAXIMUM LEAD THICKNESS INCLUDES LEAD FINISH. MINIMUM LEAD THICKNESS IS THE MINIMUM THICKNESS OF THE BASE MATERIAL.
4. DIMENSIONS D AND E DO NOT INCLUDE MOLD FLASH, PROTRUSIONS, OR GATE BURRS.

DIM	MILLIMETERS			INCHES		
	MIN	NOM	MAX	MIN	NOM	MAX
A	0.89	1.00	1.11	0.035	0.039	0.044
A1	0.01	0.06	0.10	0.000	0.002	0.004
b	0.37	0.44	0.50	0.015	0.017	0.020
c	0.08	0.14	0.20	0.003	0.006	0.008
D	2.80	2.90	3.04	0.110	0.114	0.120
E	1.20	1.30	1.40	0.047	0.051	0.055
e	1.78	1.90	2.04	0.070	0.075	0.080
L	0.30	0.43	0.55	0.012	0.017	0.022
L1	0.35	0.54	0.69	0.014	0.021	0.027
HE	2.10	2.40	2.64	0.083	0.094	0.104
T	0°	---	10°	0°	---	10°

**RECOMMENDED SOLDERING FOOTPRINT**



**GENERIC MARKING DIAGRAM\***



XXX = Specific Device Code  
M = Date Code  
▪ = Pb-Free Package

\*This information is generic. Please refer to device data sheet for actual part marking. Pb-Free indicator, "G" or microdot "▪", may or may not be present.

- |   |   |   |  |
|---|---|---|--|
| STYLE 1 THRU 5:<br>CANCELLED                                | STYLE 6:<br>PIN 1. BASE<br>2. EMITTER<br>3. COLLECTOR       | STYLE 7:<br>PIN 1. EMITTER<br>2. BASE<br>3. COLLECTOR       | STYLE 8:<br>PIN 1. ANODE<br>2. NO CONNECTION<br>3. CATHODE |
| STYLE 9:<br>PIN 1. ANODE<br>2. ANODE<br>3. CATHODE          | STYLE 10:<br>PIN 1. DRAIN<br>2. SOURCE<br>3. GATE           | STYLE 11:<br>PIN 1. ANODE<br>2. CATHODE<br>3. CATHODE-ANODE | STYLE 12:<br>PIN 1. CATHODE<br>2. CATHODE<br>3. ANODE      |
| STYLE 13:<br>PIN 1. SOURCE<br>2. DRAIN<br>3. GATE           | STYLE 14:<br>PIN 1. CATHODE<br>2. GATE<br>3. ANODE          | STYLE 15:<br>PIN 1. GATE<br>2. CATHODE<br>3. ANODE          | STYLE 16:<br>PIN 1. ANODE<br>2. CATHODE<br>3. CATHODE      |
| STYLE 17:<br>PIN 1. NO CONNECTION<br>2. ANODE<br>3. CATHODE | STYLE 18:<br>PIN 1. NO CONNECTION<br>2. CATHODE<br>3. ANODE | STYLE 19:<br>PIN 1. CATHODE<br>2. ANODE<br>3. CATHODE-ANODE | STYLE 20:<br>PIN 1. CATHODE<br>2. ANODE<br>3. GATE         |
| STYLE 21:<br>PIN 1. GATE<br>2. SOURCE<br>3. DRAIN           | STYLE 22:<br>PIN 1. RETURN<br>2. OUTPUT<br>3. INPUT         | STYLE 23:<br>PIN 1. ANODE<br>2. ANODE<br>3. CATHODE         | STYLE 24:<br>PIN 1. GATE<br>2. DRAIN<br>3. SOURCE          |
| STYLE 25:<br>PIN 1. ANODE<br>2. CATHODE<br>3. GATE          | STYLE 26:<br>PIN 1. CATHODE<br>2. ANODE<br>3. NO CONNECTION | STYLE 27:<br>PIN 1. CATHODE<br>2. CATHODE<br>3. CATHODE     | STYLE 28:<br>PIN 1. ANODE<br>2. ANODE<br>3. ANODE          |

<b>DOCUMENT NUMBER:</b>	<b>98ASB42226B</b>	Electronic versions are uncontrolled except when accessed directly from the Document Repository. Printed versions are uncontrolled except when stamped "CONTROLLED COPY" in red.
<b>DESCRIPTION:</b>	<b>SOT-23 (TO-236)</b>	<b>PAGE 1 OF 1</b>

ON Semiconductor and are trademarks of Semiconductor Components Industries, LLC dba ON Semiconductor or its subsidiaries in the United States and/or other countries. ON Semiconductor reserves the right to make changes without further notice to any products herein. ON Semiconductor makes no warranty, representation or guarantee regarding the suitability of its products for any particular purpose, nor does ON Semiconductor assume any liability arising out of the application or use of any product or circuit, and specifically disclaims any and all liability, including without limitation special, consequential or incidental damages. ON Semiconductor does not convey any license under its patent rights nor the rights of others.

**onsemi**, **Onsemi**, and other names, marks, and brands are registered and/or common law trademarks of Semiconductor Components Industries, LLC dba "**onsemi**" or its affiliates and/or subsidiaries in the United States and/or other countries. **onsemi** owns the rights to a number of patents, trademarks, copyrights, trade secrets, and other intellectual property. A listing of **onsemi**'s product/patent coverage may be accessed at [www.onsemi.com/site/pdf/Patent-Marking.pdf](http://www.onsemi.com/site/pdf/Patent-Marking.pdf). **onsemi** reserves the right to make changes at any time to any products or information herein, without notice. The information herein is provided "as-is" and **onsemi** makes no warranty, representation or guarantee regarding the accuracy of the information, product features, availability, functionality, or suitability of its products for any particular purpose, nor does **onsemi** assume any liability arising out of the application or use of any product or circuit, and specifically disclaims any and all liability, including without limitation special, consequential or incidental damages. Buyer is responsible for its products and applications using **onsemi** products, including compliance with all laws, regulations and safety requirements or standards, regardless of any support or applications information provided by **onsemi**. "Typical" parameters which may be provided in **onsemi** data sheets and/or specifications can and do vary in different applications and actual performance may vary over time. All operating parameters, including "Typicals" must be validated for each customer application by customer's technical experts. **onsemi** does not convey any license under any of its intellectual property rights nor the rights of others. **onsemi** products are not designed, intended, or authorized for use as a critical component in life support systems or any FDA Class 3 medical devices or medical devices with a same or similar classification in a foreign jurisdiction or any devices intended for implantation in the human body. Should Buyer purchase or use **onsemi** products for any such unintended or unauthorized application, Buyer shall indemnify and hold **onsemi** and its officers, employees, subsidiaries, affiliates, and distributors harmless against all claims, costs, damages, and expenses, and reasonable attorney fees arising out of, directly or indirectly, any claim of personal injury or death associated with such unintended or unauthorized use, even if such claim alleges that **onsemi** was negligent regarding the design or manufacture of the part. **onsemi** is an Equal Opportunity/Affirmative Action Employer. This literature is subject to all applicable copyright laws and is not for resale in any manner.

## PUBLICATION ORDERING INFORMATION

### LITERATURE FULFILLMENT:

Email Requests to: [orderlit@onsemi.com](mailto:orderlit@onsemi.com)

**onsemi Website:** [www.onsemi.com](http://www.onsemi.com)

### TECHNICAL SUPPORT

**North American Technical Support:**  
Voice Mail: 1 800-282-9855 Toll Free USA/Canada  
Phone: 011 421 33 790 2910

**Europe, Middle East and Africa Technical Support:**

Phone: 00421 33 790 2910

For additional information, please contact your local Sales Representative