

MATERIALS AND FINISHES

BODY, JAM NUT, CABLE CONTACT, CONTACT COVER,
CRIMP TUBE: BRASS
PLATED GOLD

CENTER CONTACT, SPRING OUTER CONTACT: BERYLLIUM COPPER
PLATED GOLD

LOCKWASHER: PHOSPHOR BRONZE
PLATED GOLD

INSULATOR: TEFLON

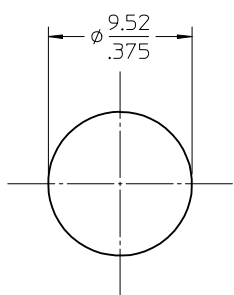
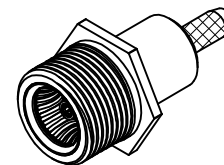
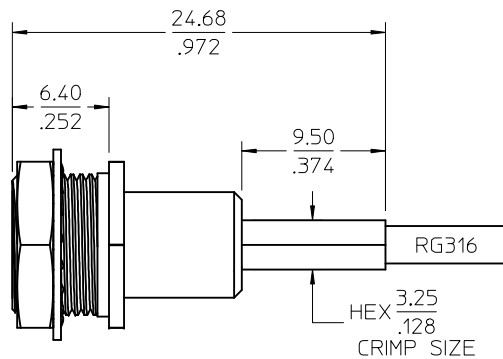

MATING HOLE DETAIL

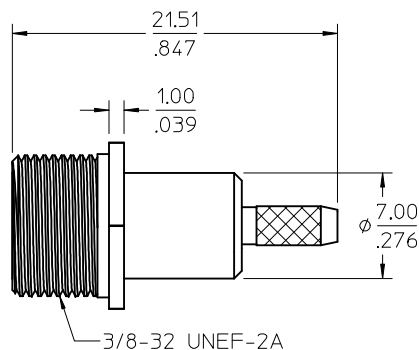
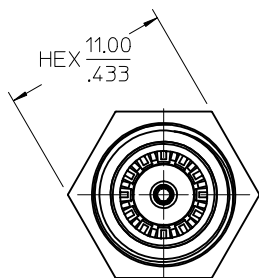

JAM NUT

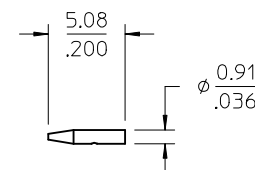

CABLE CONTACT

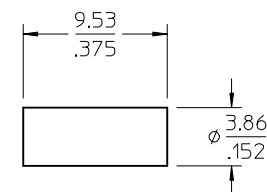

CRIMP TUBE

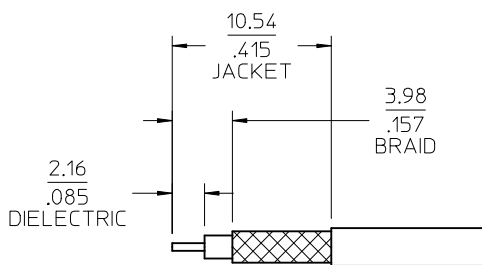

CABLE PREP DIMENSION

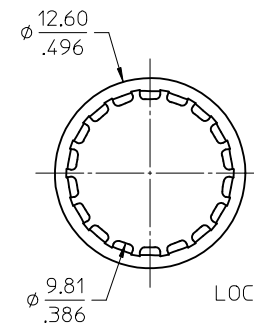
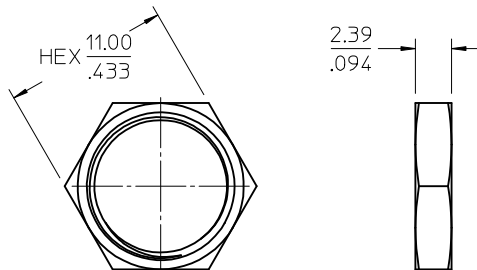

LOCK WASHER

73298-0141	BULK
73298-0140	ONE PER BAG
PART NO	PACKAGING

PS-89675-1840	ELEC/MECH PERFORMANCE
MIL-STD-348A, FIG. 321.2	INTERFACE
SPECIFICATION	DESCRIPTION

CHG: UPDATED LOCK WASHER PER RF13-E063	EC NO: URF2013-0292	2012/11/21
DRWNR: YEH	CHKD: CHANG	2012/11/21
APPR: HUANG	DESCRIPTION	
REV: A1		

QUALITY SYMBOLS	GENERAL TOLERANCES (UNLESS SPECIFIED)
▽=0	mm INCH
▽=0	4 PLACES ± --- ± ---
▽=0	3 PLACES ± --- ± ---
	2 PLACES ± --- ± ---
	1 PLACE ± --- ± ---
	0 PLACE ± --- ± ---
	ANGULAR ± 2 °
	DRAFT WHERE APPLICABLE MUST REMAIN WITHIN DIMENSIONS

DIMENSION STYLE MM/IN	
DRAWN BY JYL	DATE 2008/07/16
CHECKED BY SSS	DATE 2008/07/16
APPROVED BY JW IENER	DATE 2011/09/27
MATERIAL NO. SEE TABLE	
SIZE C	

SCALE 4:1	DESIGN UNITS METRIC	THIRD ANGLE PROJECTION
TITLE BMA JACK, BH RG316		
EWR-3686, BMA-JC/F		
molex		
DOCUMENT NO. SD-73298-014	SHEET NO. 1 OF 1	
THIS DRAWING CONTAINS INFORMATION THAT IS PROPRIETARY TO MOLEX INCORPORATED AND SHOULD NOT BE USED WITHOUT WRITTEN PERMISSION		