

Power Schottky rectifier

Datasheet - production data

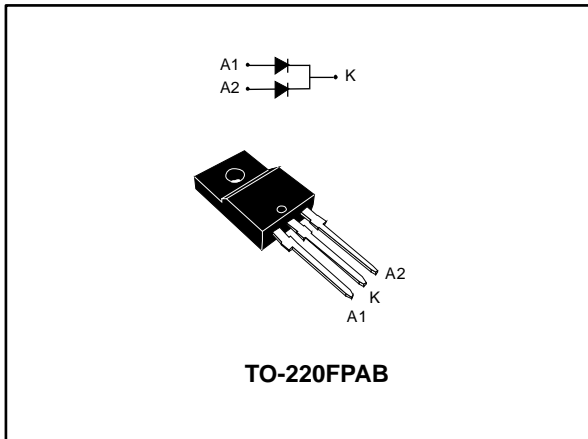

Features

- High junction temperature capability
- Optimized trade-off between leakage current and forward voltage drop
- Low leakage current
- Avalanche capability specified
- Insulated package TO-220FPAB
 - Insulated voltage: 2000 V_{RMS} sine

Description

This dual diode Schottky rectifier is suited for high frequency switch mode power supply.

Packaged in TO-220FPAB, this device is particularly suited for use in notebook, game station, LCD TV and desktop adapters, providing these applications with a good efficiency at both low and high load.

Table 1: Device summary

Symbol	Value
$I_{F(AV)}$	2 x 15 A
V_{RRM}	80 V
$T_j(max.)$	175 °C
$V_F(typ.)$	515 mV

Figure 1: Electrical characteristics

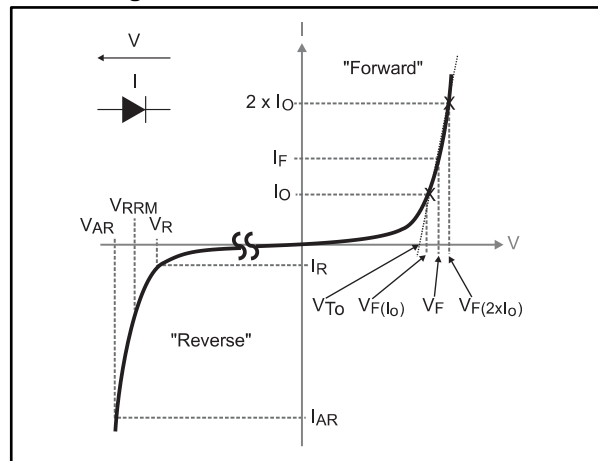

 V_{ARM} and I_{ARM} must respect the reverse safe operating area defined in Figure 9. V_{AR} and I_{AR} are pulse measurements ($t_p < 1 \mu s$). V_R , I_R , V_{RRM} and V_F , are static characteristics.

1 Characteristics

Table 2: Absolute ratings (limiting values, per diode, at 25 °C, unless otherwise specified)

Symbol	Parameter		Value	Unit	
V _{RRM}	Repetitive peak reverse voltage		80	V	
I _{F(RMS)}	Forward rms current		30	A	
I _{F(AV)}	Average forward current δ = 0.5, square wave	T _C = 105 °C	Per diode	15	A
		T _C = 70 °C	Per device	30	
I _{FSM}	Surge non repetitive forward current	t _p = 10 ms sinusoidal	220	A	
P _{ARM} ⁽¹⁾	Repetitive peak avalanche power	t _p = 10 μs, T _j = 125 °C	545	W	
V _{ARM} ⁽²⁾	Maximum repetitive peak avalanche voltage	t _p < 1 μs, T _j < 150 °C, I _{AR} < 22.8 A	100	V	
V _{ASM} ⁽²⁾	Maximum single pulse peak avalanche voltage	t _p < 1 μs, T _j < 150 °C, I _{AR} < 22.8 A	100	V	
T _{stg}	Storage temperature range		-65 to +175	°C	
T _j	Maximum operating junction temperature ⁽³⁾		175	°C	

Notes:

⁽¹⁾For pulse time duration deratings, please refer to figure 4. More details regarding the avalanche energy measurements and diode validation in the avalanche are provided in the application notes AN1768 and AN2025.

⁽²⁾See Figure 9

⁽³⁾(dP_{tot}/dT_j) < (1/R_{th(j-a)}) condition to avoid thermal runaway for a diode on its own heatsink.

Table 3: Thermal parameters

Symbol	Parameter	Max. value	Unit
R _{th(j-c)}	Junction to case	Per diode	5.30
		Total	4.20
R _{th(c)}	Coupling	3.10	°C/W

When the diodes 1 and 2 are used simultaneously:

$$\Delta T_j (\text{diode1}) = P_{(\text{diode1})} \times R_{\text{th(j-c)}} (\text{per diode}) + P_{(\text{diode2})} \times R_{\text{th(c)}}$$

Table 4: Static electrical characteristics (per diode)

Symbol	Parameter	Test conditions		Min.	Typ.	Max.	Unit
$I_R^{(1)}$	Reverse leakage current	$T_j = 25\text{ °C}$	$V_R = V_{RRM}$	-	10	40	μA
		$T_j = 125\text{ °C}$		-	7	20	mA
$V_F^{(2)}$	Forward voltage drop	$T_j = 25\text{ °C}$	$I_F = 7.5\text{ A}$	-	0.590	0.655	V
		$T_j = 125\text{ °C}$		-	0.515	0.555	
		$T_j = 25\text{ °C}$	$I_F = 15\text{ A}$	-	0.715	0.790	
		$T_j = 125\text{ °C}$		-	0.600	0.675	
		$T_j = 25\text{ °C}$	$I_F = 30\text{ A}$	-	0.860	0.965	
		$T_j = 125\text{ °C}$		-	0.710	0.830	

Notes:

(1)Pulse test: $t_p = 5\text{ ms}$, $\delta < 2\%$

(2)Pulse test: $t_p = 380\text{ }\mu\text{s}$, $\delta < 2\%$

To evaluate the conduction losses, use the following equation:

$$P = 0.520 \times I_{F(AV)} + 0.0103 \times I_{F(RMS)}^2$$

1.1 Characteristics (curves)

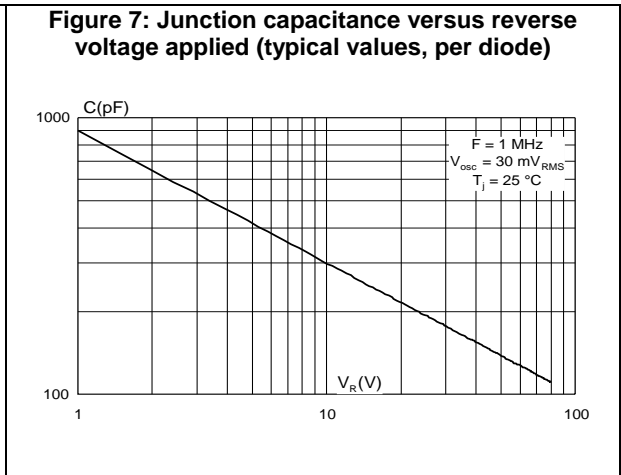
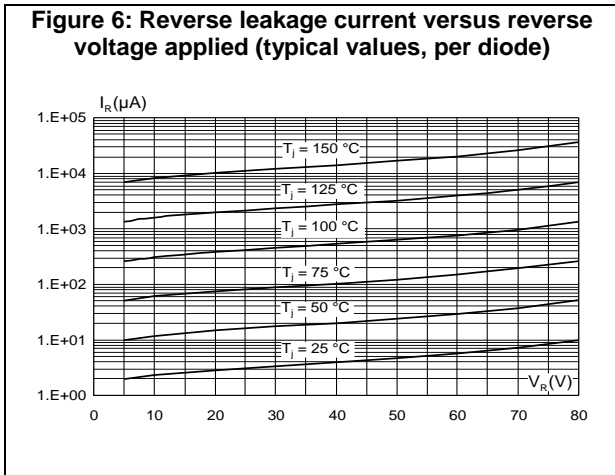
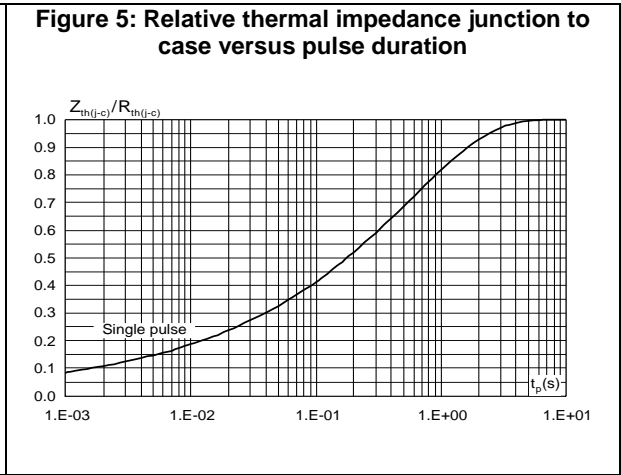
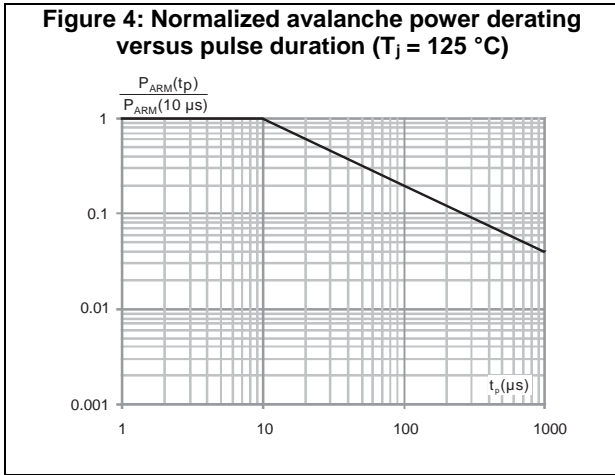
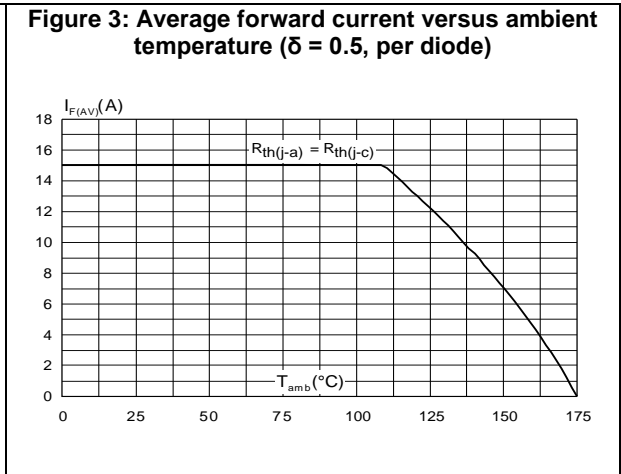
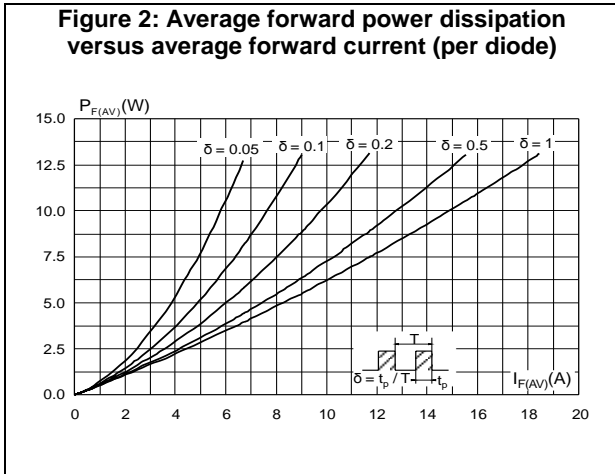

Figure 8: Forward voltage drop versus forward current (per diode)

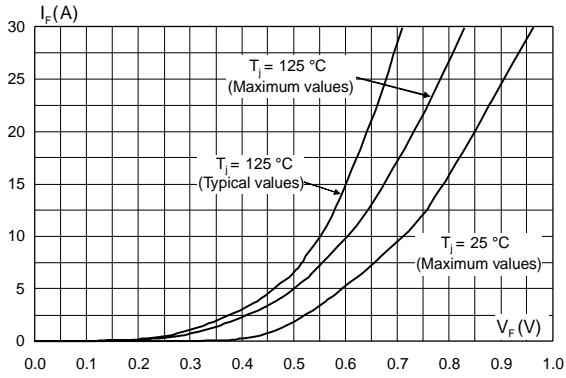
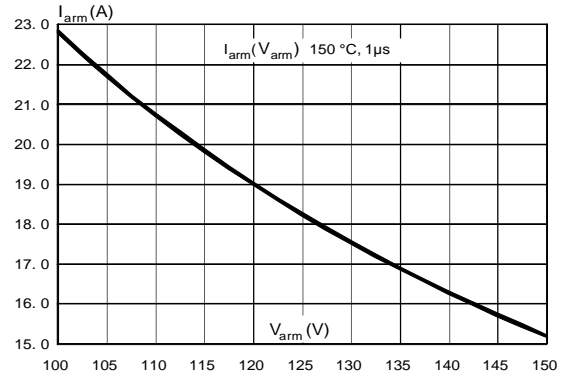

Figure 9: Reverse safe operating area ($t_p < 1\text{ }\mu\text{s}$ and $T_j < 150\text{ }^\circ\text{C}$)



2 Package information

In order to meet environmental requirements, ST offers these devices in different grades of ECOPACK® packages, depending on their level of environmental compliance. ECOPACK® specifications, grade definitions and product status are available at: www.st.com. ECOPACK® is an ST trademark.

- Cooling method: by conduction (C)
- Epoxy meets UL 94,V0
- Recommended torque value: 0.55 N·m
- Maximum torque value: 0.7 N·m

2.1 TO-220FPAB package information

Figure 10: TO-220FPAB package outline

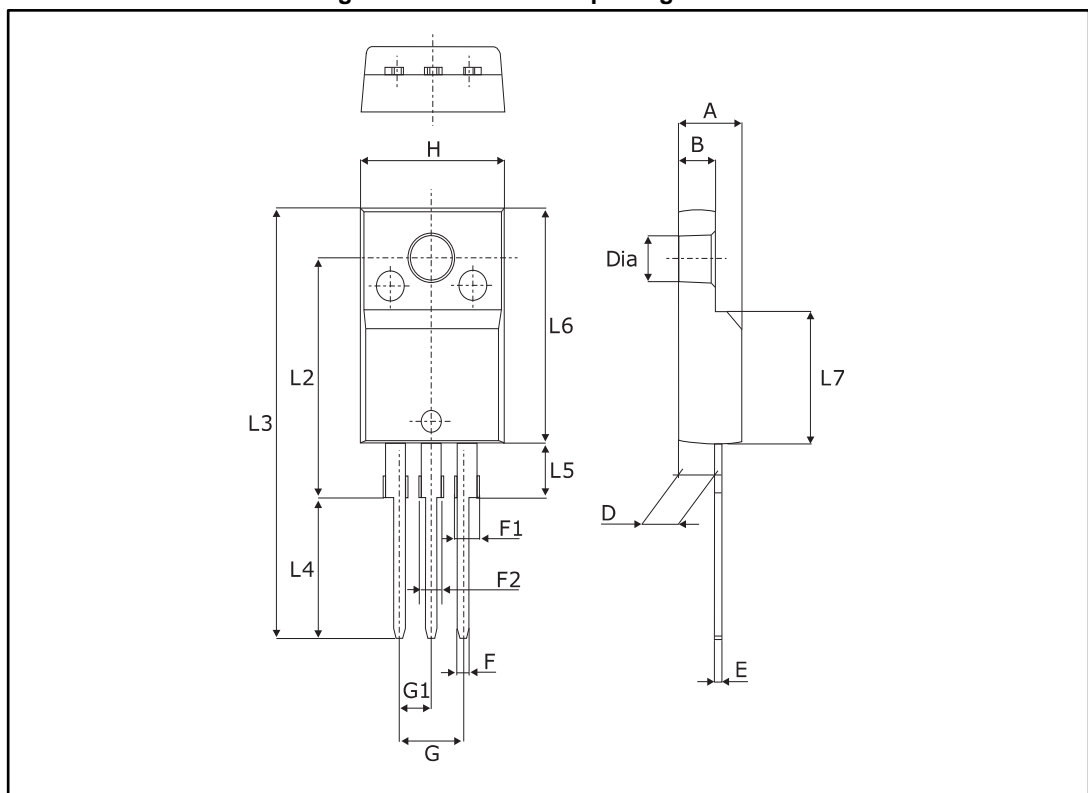

Table 5: TO-220FPAB package mechanical data

Ref.	Dimensions			
	Millimeters		Inches	
	Min.	Max.	Min.	Max.
A	4.40	4.60	0.173	0.181
B	2.5	2.7	0.098	0.106
D	2.50	2.75	0.098	0.108
E	0.45	0.70	0.018	0.027
F	0.75	1.0	0.03	0.039
F1	1.15	1.70	0.045	0.067
F2	1.15	1.70	0.045	0.067
G	4.95	5.20	0.195	0.205
G1	2.40	2.70	0.094	0.106
H	10.00	10.40	0.393	0.409
L2	16.00 typ.		0.63 typ.	
L3	28.60	30.60	1.126	1.205
L4	9.80	10.6	0.386	0.417
L5	2.90	3.60	0.114	0.142
L6	15.90	16.40	0.626	0.646
L7	9.00	9.30	0.354	0.366
Dia	3.0	3.20	0.118	0.126

3 Ordering information

Table 6: Ordering information

Order code	Marking	Package	Weight	Base qty.	Delivery mode
STPS30SM80CFP	PS30SM80CFP	TO-220FPAB	2.0 g	50	Tube

4 Revision history

Table 7: Document revision history

Date	Revision	Changes
11-Apr-2011	1	First issue.
12-May-2017	2	Removed D ² PAK, I ² PAK and TO-220AB packages.

IMPORTANT NOTICE – PLEASE READ CAREFULLY

STMicroelectronics NV and its subsidiaries ("ST") reserve the right to make changes, corrections, enhancements, modifications, and improvements to ST products and/or to this document at any time without notice. Purchasers should obtain the latest relevant information on ST products before placing orders. ST products are sold pursuant to ST's terms and conditions of sale in place at the time of order acknowledgement.

Purchasers are solely responsible for the choice, selection, and use of ST products and ST assumes no liability for application assistance or the design of Purchasers' products.

No license, express or implied, to any intellectual property right is granted by ST herein.

Resale of ST products with provisions different from the information set forth herein shall void any warranty granted by ST for such product.

ST and the ST logo are trademarks of ST. All other product or service names are the property of their respective owners.

Information in this document supersedes and replaces information previously supplied in any prior versions of this document.

© 2017 STMicroelectronics – All rights reserved