

# DATA SHEET

**SUNGMUN CODE :** NSI-10HS-TR

**DESCRIPTION :** SLIDE SWITCH

## **SUNGMUN ELECTRONICS CO., LTD.**

Address 301-302,Bucheon Technopark 345, Seokcheon-ro, Ojeong-gu

Bucheon-si, Gyeonggi-do, Korea

TEL. +82-32-328-1941~4

FAX +82-32-328-1945

E-mail [sungmun@sungmun.co.kr](mailto:sungmun@sungmun.co.kr)

Website [www.sungmun.com](http://www.sungmun.com)



**SUNGMUN**  
ELECTRONICS

MRK.	DATE	REVISION	SIGN
△			

**SPECIFICATION**

1. Rating : 0.5A, DC 12V~0.3A, DC24V
2. Contact Resistance : 30mΩ Max
3. Travel : 1.6mm
4. Operating Force : 250gf±150gf
5. Life cycle : 2,000 Cycle(with load)

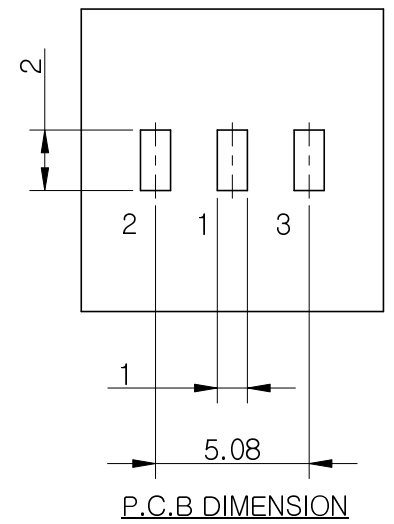
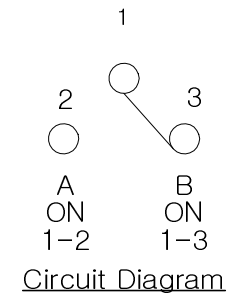
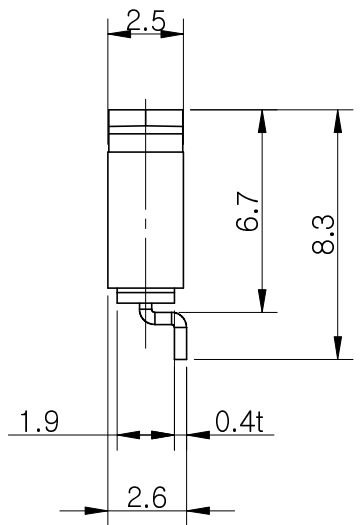
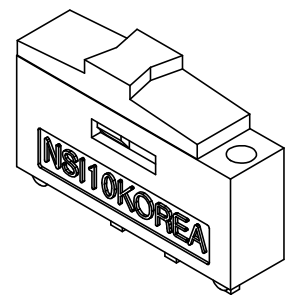
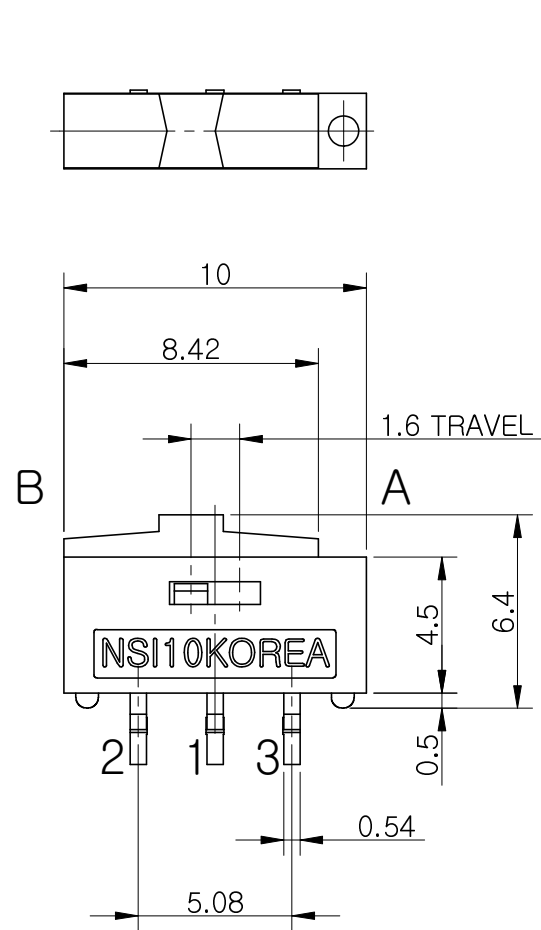

01	SLIDE SWITCH NSI-10	재질 <지정안함>	1	-
NO.	DESCRIPTION	MATERIAL	COLOR/FINISH	VENDOR
DRAW/DESIGNED	CHECKED	APPROVED	TITLE	SLIDE SWITCH NSI-10
			UNIT	SCALE
2017-01-24			mm	4:1
SUNGmun ELECTRONICS CO.,LTD			MODEL	NSI-10HS
			SIZE	A4
			DRAW NO.	NSI0-100HS-01
				SHEET 1/1

## 1. Electrical Characteristics :

- 1.1 Rating : AC, DC 12V 0.5A~24V 0.3A (Minimum current: 1mA)
- 1.2 Contact Resistance : Max 30 mΩ
- 1.3 Insulation Resistance : Min 10,000 MΩ at DC 500V
- 1.4 Withstanding Voltage : 1min at AC 500V

## 2. Mechanical Characteristics :

- 2.1 Operating Force : 250gf ± 150gf
- 2.2 Travel : 1.6mm
- 2.3 Insulator :
  - 2.3.1 Case : Glass Fiber resin
  - 2.3.2 Slide : Glass Fiber resin
- 2.4 Terminal : Nickel, Gold Plate

## 3. Life Test :

- 3.1 Test Condition : Operations at a rate of 15-20 cycles in 1 minute
  - 3.1.1 With load : 2,000 cycles
  - 3.1.2 Without load : 10,000 cycles
- 3.2 Operating Force : With +40%, -40% of Initial Value
- 3.3 Contact Resistance : Max 200mΩ

## 4. Environmental Characteristics :

- 4.1 Operating Temperature : -40°C to +85°C
- 4.2 Storage Temperature : -40°C to +85°C
- 4.3 Humidity Test :
  - 4.3.1 Test Conditions : Measured 1hour after exposure to ambient  
After 96hours exposure at 40±2°C, 90-95% R.H
  - 4.3.2 Insulation Resistance : Min 100MΩ, at DC 500V
  - 4.3.3 Withstanding Voltage : 1min at AC 250V

**5. Solder Conditions :**

- 5.1 Hand Solder : 3~4 sec. at 350°C (Dipping type)
- 5.2 Wave Solder : 5 sec. at 260°C (Dipping type)
- 5.3 Reflow Solder (SMD type)

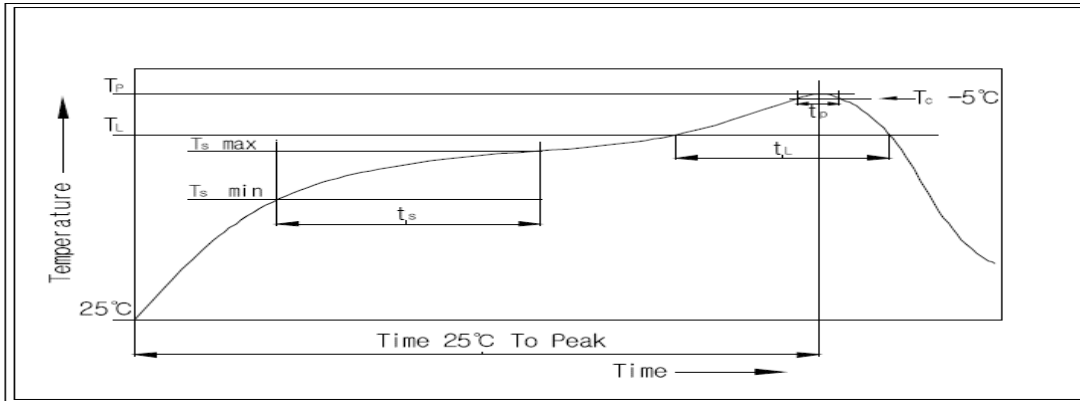

**5.3.1 Condition for Soldering**

Profile Feature	Pb-Free Assembly
Average Ramp-UP Rate(Ts max to TP)	3°C/second max
Preheat	
- Temperature Min(Ts min)	150°C
- Temperature Max(Ts max)	200°C
- Time (ts min to ts max)	60-180seconds
Time maintained above:	
- Temperature (TL)	217°C
- Time (tL)	60-150seconds
Peak/Classification Temperature(TP)	260°C +0°C/ -5°C
Time within 5°C of actual Peak Temperature(TP)	5~10 seconds
Ramp-Down Rate	6°C/sec max
Time 25°C to Peak Temperature	8 minutes max

MOLD NO. 24M/M

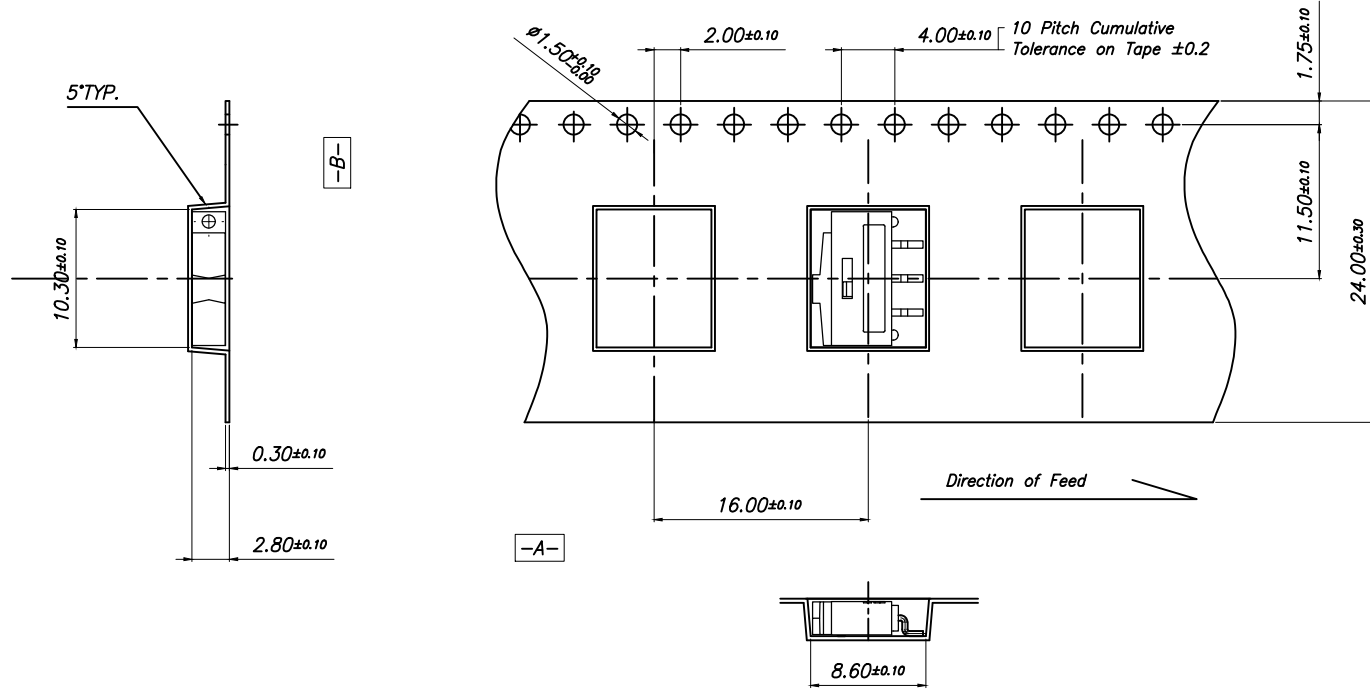

REEL	TYPE	COLOR	HUB	SIZE
	PLASTIC	BLACK	80	330
SHEET	BLACK 24MMX0.3	PACKING QUANTITY	1500/REEL	

NOTES: (UNLESS OTHERWISE SPECIFIED)

1. 10 SPROCKET HOLE PITCH CUMULATIVE TOL  $\pm 0.2$
2. CAMBER NOT TO EXCEED 1mm IN 250mm.
3. MATERIAL : BLACK CONDUCTIVE POLYSTYRENE.
4.  $K_0$  MEASURED FROM A PLANE ON THE INSIDE BOTTOM OF THE POCKET TO THE TOP SURFACE OF THE CARRIER.
5. POCKET POSITION RELATIVE TO SPROCKET HOLE MEASURED AS TRUE POSITION OF POCKET, NOT POCKET HOLE.
6. ALL DIMENSIONS ARE IN MILLIMETERS.

UNLESS OTHERWISE SPECIFIED: DIMENSIONS ARE IN MILLIMETERS TOLERANCE DECIMALS      ANGULAR X.X $\pm 0.13$ $\pm 1^\circ$ X.XX $\pm 0.10$ DO NOT SCALE DRAWING UNIT                  mm THIRD ANGLE PROJECTION	SCALE	NON SCALE	TITLE		
	DATE	2018.11.16	NSI-10-HS		
	DRAWN	DESIGNED	CHECKED	APPROVED	CUSTOMER
	W.J LEE		J.P ROH	K.J LEE	MODEL NO
	SUNG MUN ELECTRONICS., LTD				DWG NO
NSI-10HS					