

Small Type High-Speed Response POL DC-DC Converter

Bellnix®

BSV-nano Series

BSV-nano Series is a small (11x11x3.2mm), light, 4A output step-down DC-DC converter with low output voltage from 0.8V and an accuracy of $\pm 1\%$ typ. It can support the latest DSP, ASIC applications. High efficiency and high-speed response with synchronous rectification have been achieved along with space-saving packaging. This product will exceed your expectations.

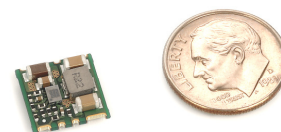

■ Features

- Ultra Small 11x11mm
- Ultra Thin 3.2mm
- High-Speed Load Response
- Output Accuracy $\pm 1\%$
- High Efficiency
- Over Current Protection
- Under Voltage Lock Out
- Remote ON/OFF Control
- Adjustable Output Voltage
- Surface Mount Package
- Heat Sink Not Required
- Non-Isolated Type converter
- Operating Temp Range
-40°C to +85°C
Temp Derating Required
- RoHS Compliant

■ Model/Rating

Table 1

Models BSV-nano Series	Input V Vdc	Output V Vdc	Output I A	Output ADJ Vdc	Ripple Noise mVpp(typ)	Efficiency %(typ)
BSV-1.8S4R0NA	3.0 - 5.5	1.8	0 - 4.0	0.8 - 1.8	10	87

Note 1: Ripple noise, efficiency value is when input voltage is 5V and load is rated.

Note 2: Ripple noise is measured at 20MHz bandwidth, with a multi layered ceramic capacitor with 47 μ F at input and 22 μ F at output.

Note 3: Depending on ambient temperature, cooling airflow may be required.

■ Specification

Table 2

Input voltage range	Refer to Table 1
Rated output voltage	1.8V $\pm 1\%$ typ (Trim pin OPEN)
Adjustable output voltage range	0.8-1.8V
Line regulation	0.2%typ (Rated output, input voltage varying from 3.0 to 5.5)
Load regulation	0.2%typ (Rated input/output voltage, load varying from 0 to 100%)
Temp regulation	0.007%/°C typ. (Rated input/output, Operating temp varying from -40°C - +70°C)
Ripple noise	Refer to Table 1 (Rated input/output, Common temp, measurement frequency bandwidth 20MHz)
Efficiency	90% typ. at Output current 2A 87% typ. at Output current 4A (Refer to Table1)
Start up time	2.8ms typ (Resistance load)
Max output load capacity	2200 μ F max
Over current protection	Operate at 105% or above of rated load current, Auto restart type
Over voltage protection	None
Under Voltage Lock Out	Yes
Input over current protection	None
Remote ON/OFF control	Between 7pin (ON/OFF) - 5pin (GND) :Output is ON when open, output is OFF when short.(Please refer to pg8)
Standby current	0.2mA typ
P-Good signal	Normal output :HIGH Abnormal output : LOW (Open drain)
Remote sensing	Yes
Operating temp range	-40°C - +85°C (Refer to pg4 for derating)
Storage temp range	-40°C - +85°C
Humidity range	20 to 95%R.H. (Max wet bulb temp 35°C with no condensation)
Storage conditions	Below 30°C/60% R.H. before mounting the converter
Cooling conditions	Refer to pg4 for derating
Vibration	5-10Hz total altitude 10mm, 10 to 55Hz acceleration 2G (1H for each of three directions)
Impact	Acceleration 20G, (3 times for each of three directions), Impact time: 11 \pm 5ms
Weight	1.0g typ
Dimensions	W=11.0 L=11.0 H=3.2 (mm) Refer to pg5 for details.

*The above specification is provided with rated value, unless otherwise specified.

*The contents provided in this datasheet may be changed at any time without notice.

Small Type High-Speed Response POL DC-DC Converter

Bellnix[®]

BSV-nano Series

1. Usage range

This specification is for direct input, non-isolated type DC-DC converter BSV-1.8S4R0NA.

2. Model Name/Rating

Model Type	Rated input voltage	Rated output	Package	Memo
BSV-1.8S4R0NA	DC5.0V	1.8V, 4.0A	SMD	

Input/output will be rated and ambient temp is at 25°C±5°C unless otherwise specified.

3. Environmental conditions

3-1. Temp Range

Active	-40°C - +85°C (Derating required)
Storage	-40°C - +85°C

3-2. Humidity Range

Active	20 - 95%RH (The max wet bulb temp is 35°C with no condensation)
Storage	20 - 95%RH (The max wet bulb temp is 35°C with no condensation)

Note: A condition of the storage before mounting should be less than 30°C/60%R.H.

4. Specification/Rating

The product is RoHS compliant.

4-1. Input characteristics

Item	Specification/Rating	Conditions
Input voltage	+3.0 - 5.5V (Rating at 5.0V)	
Input current	1.7A typ.	During rated input/output
Standby current	0.2mA typ.	V _{in} =5.0V, SHORT between ON/OFF pin – GND pin

4-2. Output characteristics/Functions

*1, *2

Item	Specification/Rating	Conditions
Output voltage	1.8V	
Output voltage accuracy	1.8V±1.0% typ. ±1.5% (±0.027V) max.	
Adjustable output voltage	0.8V - 1.8V	External resistor required
Output current	0 - 4.0A	
Line Regulation	0.2% typ. 0.4% max.	Input varying from 3.0 to 5.5V
Load Regulation	0.2% typ. 0.4% max.	Load varying from 0 to 4.0A
Temp Regulation	±0.007%/°C typ.	Temp varying from -40°C to +70°C
Efficiency	90% typ. (I _o =2.0A), 87% typ. (I _o =4.0A)	
Ripple noise	10mVp-p typ. 50mVp-p max.	Bw=20MHz, Measured at both sides of an external capacitor
Over current protection	Operate at 105% or above, Auto restart type	
Over voltage protection	No	
Under voltage lock out	Yes Start-up voltage: 2.85 typ. Stop voltage: 2.75 typ.	
ON/OFF control	Between ON/OFF pin and GND pin Open ----- Output ON Short(0 - 0.9V 0.2mA typ.) ----- Output OFF	
P-Good low level voltage	0.3V max.	Sink current 4mA max.
Max output load capacity	2200μF max.	

*1 Referring to measurement circuit in section 4-3.

*2 The above items are measured with input voltage at 5.0V, output voltage 1.8V, output current 4.0A and the ambient temp at 25°C±5°C unless otherwise noted.

4-3. Measurement Circuit

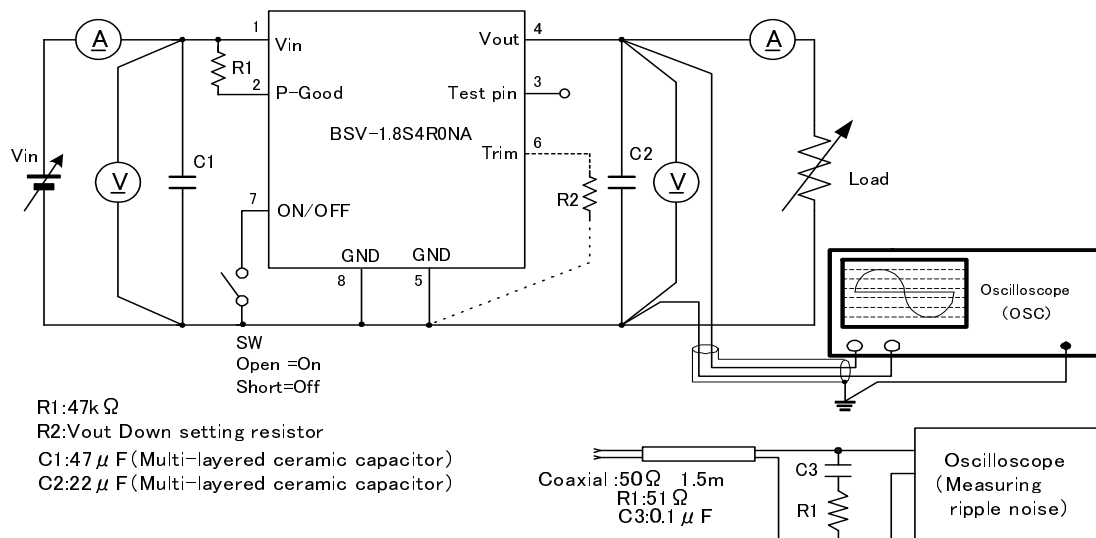

5. Temperature Derating

The product requires to be placed on PCB with good airflow due to a design to release heat through the PCB. The patterns to the converter should be taken thick and wide, especially lines to GND pin, for it has a larger heat release.

The derating curve below is when BSV-1.8S4R0NA is mounted onto the double-sided board (Copper coating thickness 35µm, Copper coating dimension 100mm x 100mm, PCB thickness 1.6mm). The heat release characteristics may change depending on wiring.

Since the temperature characteristics are largely affected by PCB and the ambient temperature, it is important to make sure that IC surface temp of the converter does not exceed 120°C when operated at the max ambient temperature in an actual device.

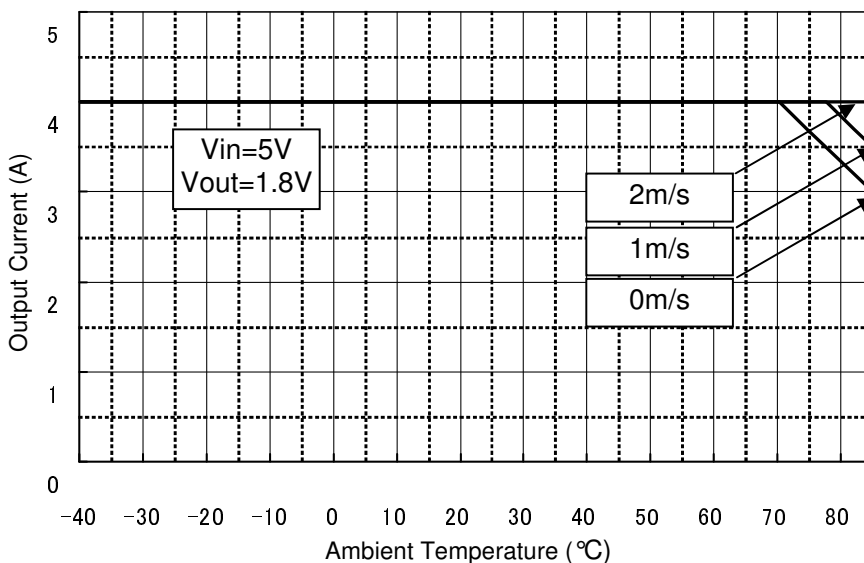
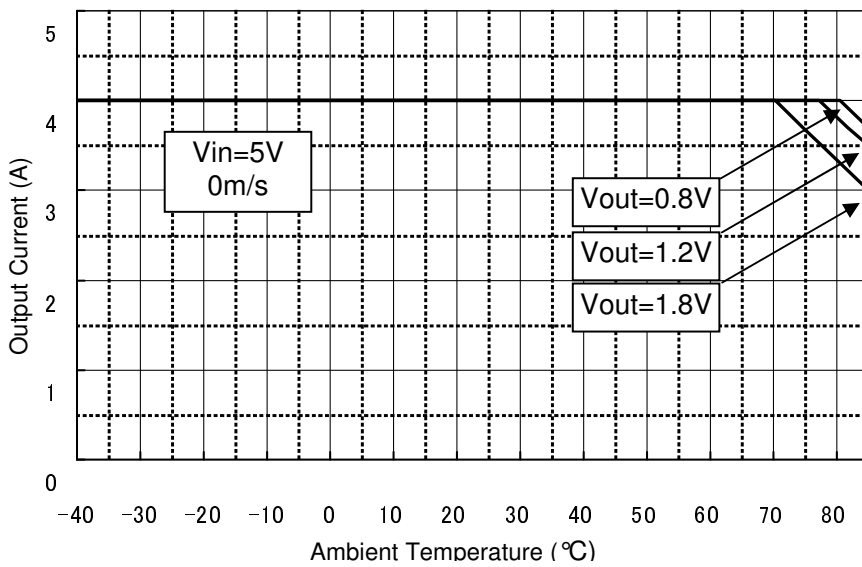

6. Outer dimensions and pin information

6-1. Configurations/Dimensions

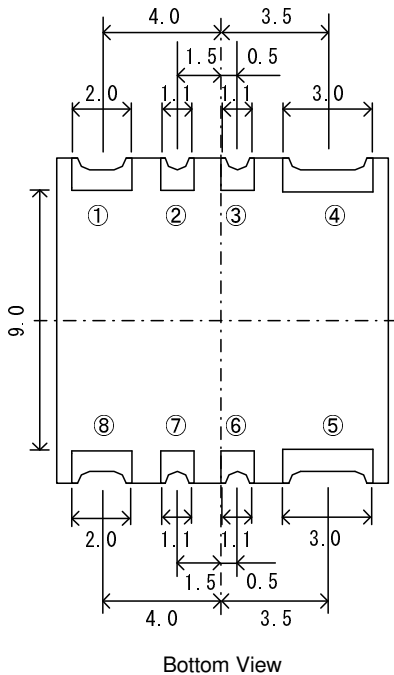
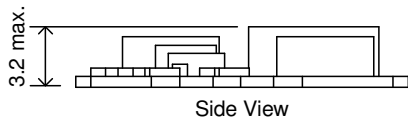
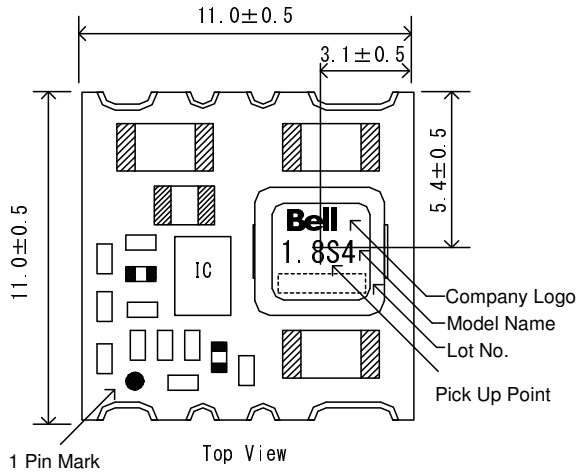

- Unit mm
- Tolerance unless otherwise specified ± 0.2
- Weight = 1.0g typ
- Pick up point: See the drawing on the left for the position
- Pin's variation is 0.2 mm max (when placed on the level).
- Pin material and plating
Material: Copper
Plating: Nickel plating followed by gold plating

Note)

Make sure to use a pick up point as indicated in the drawing on the left during auto-mounting. Picking up at IC has to be avoided.

Pin	Function
①	Vin
②	P-Good
③	Test pin
④	Vout
⑤	GND
⑥	Trim
⑦	ON/OFF
⑧	GND

6-2. Recommended footprint

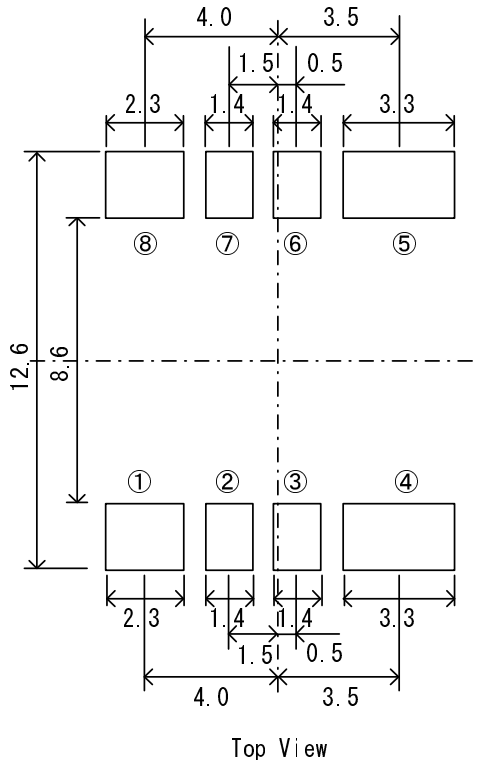

Note: Do not wire in the area on PCB where the converter is placed since it has its own wiring at the bottom.

Note: The above measurement is a recommended footprint as a reference. Footprints may vary depending on customer's requirements.

6-3. Lot Display

0 1 (Manufactured in 2010, January)

0 D 2 (Manufactured in 2010, December)

└─ Internal Number (There may be no indication)

└─ Manufacturing Month (1st-9th month = Jan-Sep, 10th month=Oct, 11th month=Nov, 12th month=Dec)

└─ Manufacturing Year (Last digit of the year)

7. Usage information

7-1. Standard connection diagram

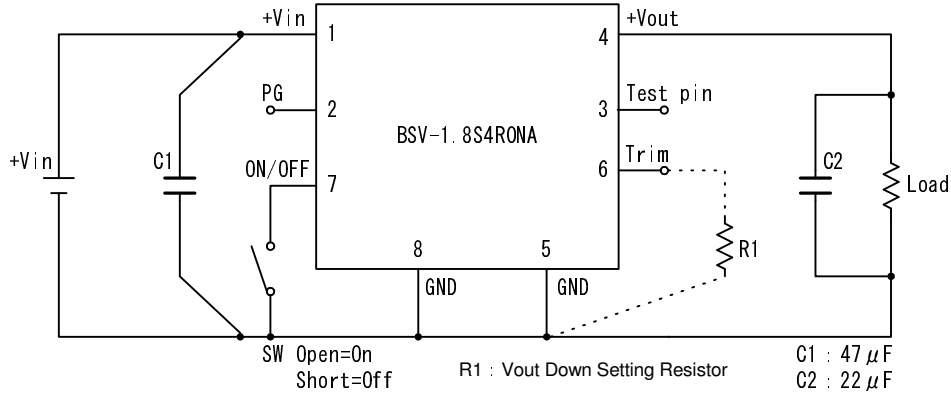

Note1: The product requires to be mounted on the PCB since most of the heat is released mainly through GND pins (5, 8pin) and the rest through +Vin pin and +Vout pin. The patterns should be taken wide enough to release heat when designing. It is important that surface temp of IC does not exceed 120°C.

Note2: Keep ON/OFF pin open when not using ON/OFF control.

Note3: P-Good pin is an open drain output. Use P-Good feature with input voltage pulled up by resistance.

Note4: Keep Trim pin open when not using adjustable output.

Note5: Keep Test pin (3pin) open and fix the converter on the board with a land. It is important that the land should not be connected to GND or +Vin lines.

Note6: GND pins (5, 8pin) are connected internally. These two pins should be connected to GND line to make the best use of the product.

Recommended capacitor

C1 = 47μF

C2 = 22μF - 200μF

C1: Not required as long as impedance is very low and lines between +Vin side and the converter are connected thick and short. For high impedance, adding an organic semiconductor solid capacitor or a multi-layered ceramic capacitor is recommended.

C2: Not required due to an internal output capacitor. A multi-layered ceramic capacitor will be recommended if noise reduction is required and it should be placed on the load side.

7-2. ON/OFF control

Output voltage can be turned on and off without disconnecting input by using ON/OFF control feature. The ON/OFF pin is connected to +Vin pin internally and has to be kept OPEN when not using the ON/OFF feature.

At 3.3V input

- ON OPEN between ON/OFF pin (7pin) and GND pin (5pin) or HIGH (2.6V – 5.5V)
- OFF SHORT between ON/OFF pin (7pin) and GND pin (5pin) or LOW (0.65V or below)

At 5.0V input

- ON OPEN between ON/OFF pin (7pin) and GND pin (5pin) or HIGH (3.75V – 5.5V)
- OFF SHORT between ON/OFF pin (7pin) and GND pin (5pin) or LOW (0.9V or below)

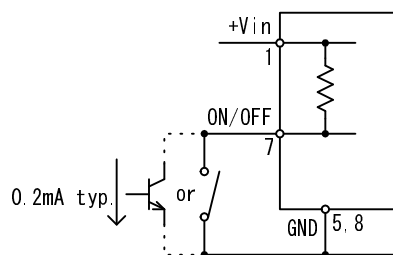

7-3. Adjustable method for output voltage

Keep Trim pin (6pin) OPEN, when using output voltage at 1.8V without adjustment. Output voltage may be adjusted between 0.8 and 1.8V by connecting a resistor between Trim pin (6pin) and GND pin (5pin).

Wiring for Trim pin should be short and straight preferably when using adjustable output voltage feature. If noise appears on the pin, it causes mal-function.

The below formula should be referred for external resistance. It is important to check output voltage and adjust resistance in an actual device

When setting output voltage between 0.8V and 1.8V

$$R_x = \frac{R_2 \times V_{out}}{R_2 \times I_1 - V_{out}} - R_1 \quad (\Omega)$$

R1=47000 (Ω) , R2=63800 (Ω) , I1=0.000028186 (A) , Vout=Desired output voltage (V)

e.g.

Output voltage (V)	Rx calculated value (kΩ)
1.8	OPEN
1.5	273.85
1.2	80.97
1.0	32.92
0.8	4.13

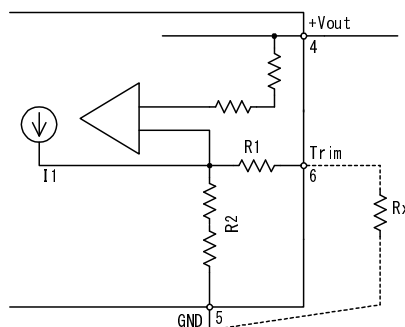

7-4 P-Good pin

Output state of the converter may be obtained by using P-Good pin (2pin), an open drain output. The P-Good features can be used by placing a resistor between +Vin pin and P-Good pin (5.5Vmax). When output voltage goes out of the converter's pre-set range, P-Good pin becomes SHORT (LOW).

Output voltage – Set voltage | $\leq 0.2V$ typ \rightarrow OPEN (HIGH)

However, even if the above conditions are fulfilled, output voltage may decrease to low under the following circumstances.

- At start-up (4ms typ)
- Input voltage 3V or below
- Over current state
- IC's surface temp 120°C or above

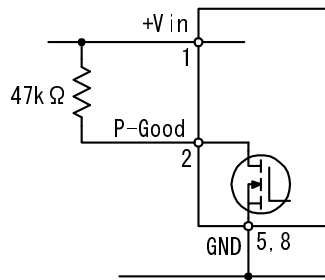

Amount of start-up time required for activating output voltage and P-Good signal

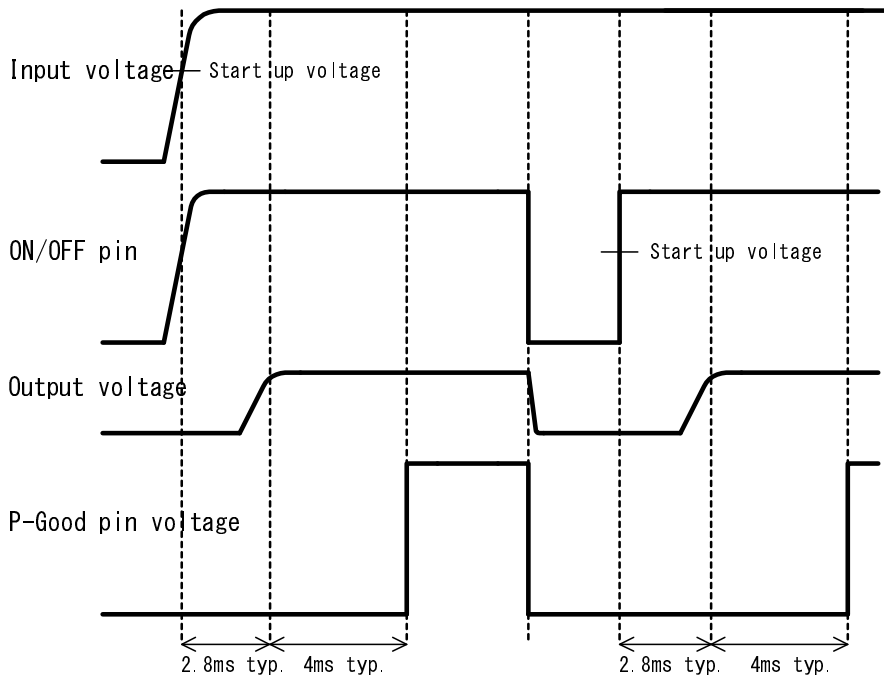

8. Protection method against reverse connection for input power supply (e.g.)

The product will break if the input polarity is connected in reverse. Adding protection circuit is recommended as shown below.

A diagram below includes a fuse and a diode.

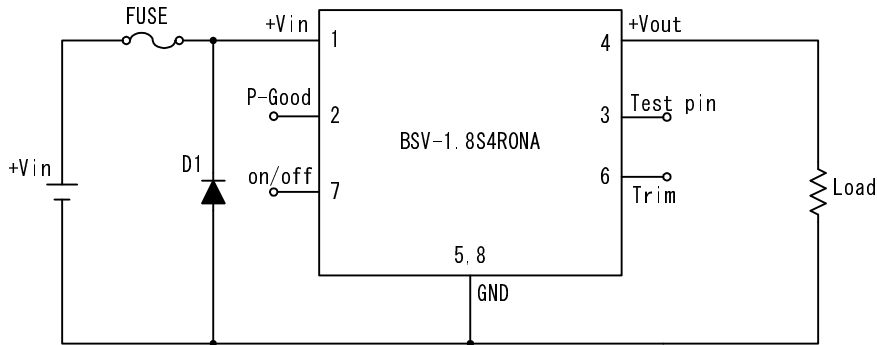

9. Over voltage protection circuit (e.g.)

The product does not have over voltage protection feature.

When switch element inside the product breaks in short mode, DC input voltage will be reflected directly to the output. Therefore an input shut-off circuit below is recommended in case of breakage in over voltage mode.

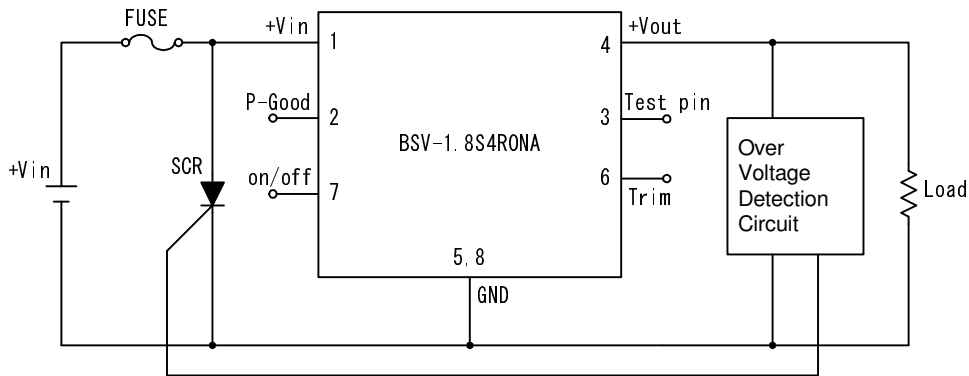

Note1: ON/OFF control will not work when the converter breaks in an over voltage mode.

Note2: If there is ON/OFF control feature on the electrical supply source side, it can also be used.

Note3: DC power supply should have enough capacity to melt a fuse.

10. Mounting conditions

Conditions stated below are required to be followed when storing before mounting. Flow soldering should be avoided.

10-1. Re-flow method

Pre-heat temp: 150 - 180°C, 60sec max. (Refer to the chart below)

Peak temp: 250°C max.
220°C or above, 60sec max.

Number of re-flows: twice

Note1) Make sure not to vibrate during re-flow or components of the converter may be dislocated.

Note2) After mounting the converter to PCB, re-flow can not be repeated with the PCB turned upside down.

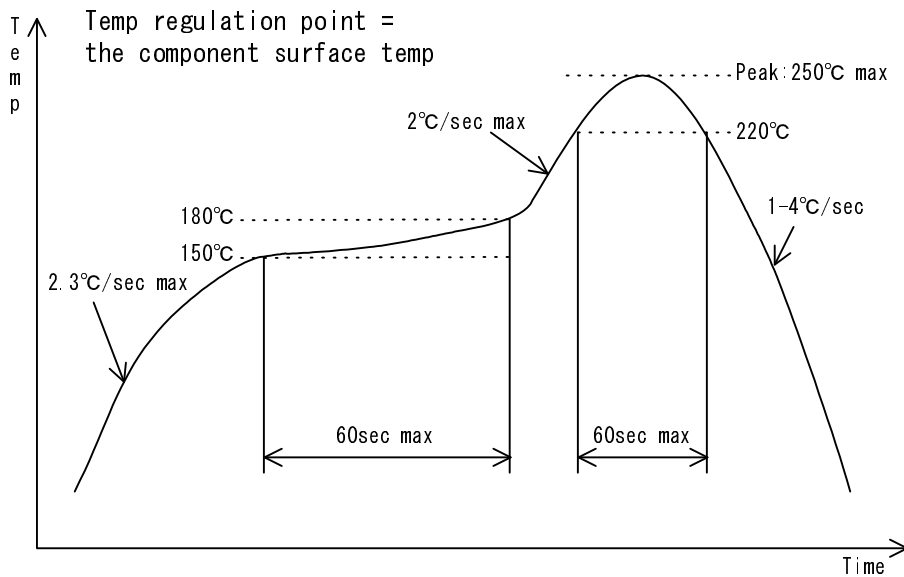

10-2. Storage before mounting

This is a MSL 3 product. Store the product at 30°C/60% RH or below after opening the dry pack. Baking (125°C ±5°C, 12H) is required before the re-flow if the storage period exceeds one year in a dry pack condition and 168 hours at 30°C/60% RH in an open dry pack condition.

11. Vibration and shock test

Vibration 5-10Hz All amplitudes 10mm, 10-55Hz Acceleration 2G (3 direction for 1H each)

Shock Acceleration 20G (3 direction, 3 times each)
Shock time 11±5ms

12. Cleaning conditions

The product can not be washed as a whole. Non-scrub flux is recommended.

13. Precautions

For the safety of our customer, please follow all warnings and specifications stated below.

- This product is intended for use in general electronic appliances (office work machines, telecommunication equipment and measurement equipment). Do not use for medical equipment, nuclear power equipment and trains, etc. where the malfunction and damage of this product may directly cause harm to human life and/or property. Confirmation is recommended when using in other than general electronic equipment.
- Parallel and serial operations are not possible.
- Refrain from using connectors and sockets when mounting the product. The performance may not be fulfilled by the effect of contacting resistors. Make sure to mount onto the PCB by soldering.
- Though over current and short circuit protections are built in, long time use in short circuit should be avoided since it may cause failure to the product.
- The product may be damaged if used in environments where the electric and temp characteristics are out of specification.
- Do not store this product where corrodible gases and dusts may generate.
- There is a possibility that the product may be damaged from static electricity. The workers should discharge all static electricity before handling the product and the work atmosphere should also have a static countermeasure.
- This product does not have a fuse built in. When the converter is in an abnormal state, please connect a fuse into +input line as a protection of over current. The electrical supply source should have enough capacity to be able to shut down a fuse.
- The product does not have an over voltage protection circuit built in. When large amount of voltage occur inside the module, there is a mode in which it is directly released from the output and may cause smoke or fire. Therefore, an over voltage protection circuit should always be added.
- No test certificate is attached to the product.

14. Warranty

The period of warranty for this product is 1 year. During this time, if any defects occur in which our company's design or production is to blame we will either fix the product or trade with a new one free of charge. However, this warranty is voided if the product has been internally modified or adjusted. The warranty covers only the stated products in this datasheet.

15. If you have any further technical questions for this product,

Please contact us:

E-mail: info@bellnix.com

<http://www.bellnix.com>