

54AC273 Octal D Flip-Flop

General Description

The '273 has eight edge-triggered D-type flip-flops with individual D inputs and Q outputs. The common buffered Clock (CP) and Master Reset (\overline{MR}) input load and reset (clear) all flip-flops simultaneously.

The register is fully edge-triggered. The state of each D input, one setup time before the LOW-to-HIGH clock transition, is transferred to the corresponding flip-flop's Q output.

All outputs will be forced LOW independently of Clock or Data inputs by a LOW voltage level on the \overline{MR} input. The device is useful for applications where the true output only is required and the Clock and Master Reset are common to all storage elements.

Features

- Ideal buffer for microprocessor or memory
- Eight edge-triggered D flip-flops
- Buffered common clock
- Buffered, asynchronous master reset
- See '377 for clock enable version
- See '373 for transparent latch version
- See '374 for TRI-STATE® version
- Outputs source/sink 24 mA
- 'ACT has TTL-compatible inputs
- Standard Military Drawing (SMD)
— 'AC273: 5962-87756

Logic Symbols

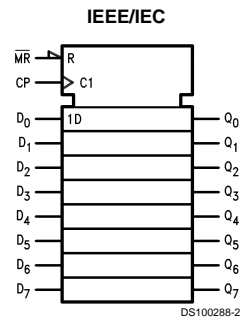
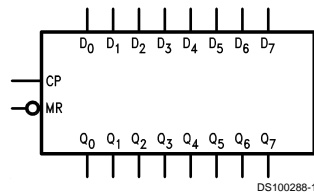

| Pin Names | Description |
|--------------------------------|-------------------|
| D ₀ -D ₇ | Data Inputs |
| \overline{MR} | Master Reset |
| CP | Clock Pulse Input |
| Q ₀ -Q ₇ | Data Outputs |

TRI-STATE® is a registered trademark of National Semiconductor Corporation.
FACT™ is a trademark of National Semiconductor Corporation.

Connection Diagrams

Pin Assignment
for DIP and Flatpak

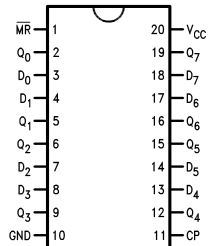

DS100288-3

Pin Assignment
for LCC

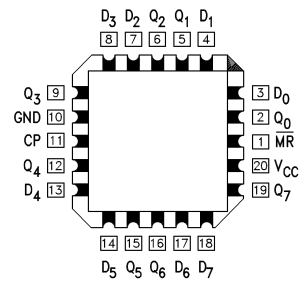

DS100288-4

Mode Select-Function Table

| Operating Mode | Inputs | | | Outputs |
|----------------|-----------------|----|-------|---------|
| | \overline{MR} | CP | D_n | Q_n |
| Reset (Clear) | L | X | X | L |
| Load '1' | H | ↗ | H | H |
| Load '0' | H | ↗ | L | L |

H = HIGH Voltage Level
L = LOW Voltage Level
X = Immaterial
↗ = LOW-to-HIGH Transition

Logic Diagram

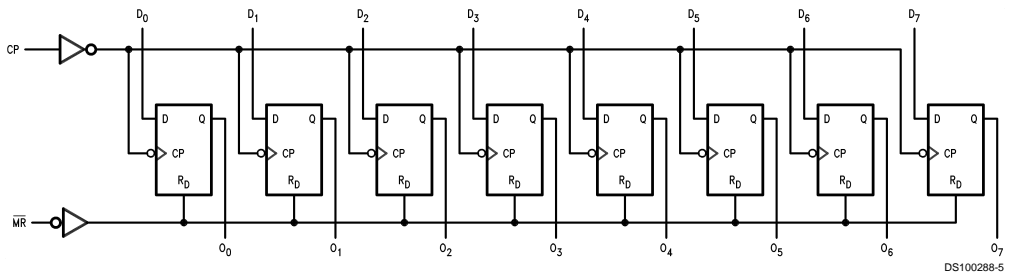

DS100288-5

Please note that this diagram is provided only for the understanding of logic operations and should not be used to estimate propagation delays.

Absolute Maximum Ratings (Note 1)

If Military/Aerospace specified devices are required, please contact the National Semiconductor Sales Office/ Distributors for availability and specifications.

| | |
|--|-----------------------------|
| Supply Voltage (V_{CC}) | -0.5V to +7.0V |
| DC Input Diode Current (I_{IK}) | |
| $V_I = -0.5V$ | -20 mA |
| $V_I = V_{CC} + 0.5V$ | +20 mA |
| DC Input Voltage (V_I) | -0.5V to $V_{CC} + 0.5V$ |
| DC Output Diode Current (I_{OK}) | |
| $V_O = -0.5V$ | -20 mA |
| $V_O = V_{CC} + 0.5V$ | +20 mA |
| DC Output Voltage (V_O) | -0.5V to to $V_{CC} + 0.5V$ |
| DC Output Source or Sink Current (I_O) | ±50 mA |
| DC V_{CC} or Ground Current per Output Pin (I_{CC} or I_{GND}) | ±50 mA |
| Storage Temperature (T_{STG}) | -65°C to +150°C |

Junction Temperature (T_J)
CDIP

175°C

Recommended Operating Conditions

| | | |
|---|-------------|-----------------|
| Supply Voltage (V_{CC}) | 'AC | 2.0V to 6.0V |
| Input Voltage (V_I) | | 0V to V_{CC} |
| Output Voltage (V_O) | | 0V to V_{CC} |
| Operating Temperature (T_A) | 54AC | -55°C to +125°C |
| Minimum Input Edge Rate ($\Delta V/\Delta t$) | 'AC Devices | |
| V_{IN} from 30% to 70% of V_{CC} | | |
| V_{CC} @ 3.3V, 4.5V, 5.5V | | 125 mV/ns |

Note 1: Absolute maximum ratings are those values beyond which damage to the device may occur. The databook specifications should be met, without exception, to ensure that the system design is reliable over its power supply, temperature, and output/input loading variables. National does not recommend operation of FACT™ circuits outside databook specifications.

DC Characteristics for 'AC Family Devices

| Symbol | Parameter | V_{CC} (V) | 54AC | Units | Conditions | |
|-----------|---|-----------------|----------------------------|-------|--|--|
| | | | $T_A =$ -55°C to +125°C | | | |
| | | | Guaranteed Limits | | | |
| V_{IH} | Minimum High Level Input Voltage | 3.0 | 2.1 | V | $V_{OUT} = 0.1V$ or $V_{CC} - 0.1V$ | |
| | | 4.5 | 3.15 | | | |
| | | 5.5 | 3.85 | | | |
| V_{IL} | Maximum Low Level Input Voltage | 3.0 | 0.9 | V | $V_{OUT} = 0.1V$ or $V_{CC} - 0.1V$ | |
| | | 4.5 | 1.35 | | | |
| | | 5.5 | 1.65 | | | |
| V_{OH} | Minimum High Level Output Voltage | 3.0 | 2.9 | V | $I_{OUT} = -50 \mu A$ | |
| | | 4.5 | 4.4 | | | |
| | | 5.5 | 5.4 | | | |
| | | | 3.0 | 2.4 | V | (Note 2) $V_{IN} = V_{IL}$ or V_{IH} $I_{OH} = -12 \text{ mA}$ $I_{OH} = -24 \text{ mA}$ $I_{OH} = -24 \text{ mA}$ |
| | | | 4.5 | 3.7 | | |
| | | | 5.5 | 4.7 | | |
| V_{OL} | Maximum Low Level Output Voltage | 3.0 | 0.1 | V | $I_{OUT} = 50 \mu A$ | |
| | | 4.5 | 0.1 | | | |
| | | 5.5 | 0.1 | | | |
| | | | 3.0 | 0.50 | V | (Note 2) $V_{IN} = V_{IL}$ or V_{IH} $I_{OL} = 12 \text{ mA}$ $I_{OL} = 24 \text{ mA}$ $I_{OL} = 24 \text{ mA}$ |
| | | | 4.5 | 0.50 | | |
| | | | 5.5 | 0.50 | | |
| I_{IN} | Maximum Input Leakage Current | 5.5 | ±1.0 | μA | $V_I = V_{CC}, GND$ | |
| I_{OLD} | (Note 3) Minimum Dynamic Output Current | 5.5 | 50 | mA | $V_{OLD} = 1.65V \text{ Max}$ | |
| I_{OHD} | | 5.5 | -50 | mA | $V_{OHD} = 3.85V \text{ Min}$ | |

DC Characteristics for 'AC Family Devices (Continued)

| Symbol | Parameter | V _{CC} (V) | 54AC | | Units | Conditions |
|-----------------|-------------------------------------|------------------------|-------------------------------------|--|-------|---|
| | | | T _A = -55°C to +125°C | | | |
| | | | Guaranteed Limits | | | |
| I _{CC} | Maximum Quiescent Supply Current | 5.5 | 80.0 | | μA | V _{IN} = V _{CC} or GND |

Note 2: All outputs loaded; thresholds on input associated with output under test.

Note 3: Maximum test duration 2.0 ms, one output loaded at a time.

Note 4: I_{IN} and I_{CC} @ 3.0V are guaranteed to be less than or equal to the respective limit @ 5.5V V_{CC}.

I_{CC} for 54AC @ 25°C is identical to 74AC @ 25°C.

AC Electrical Characteristics

| Symbol | Parameter | V _{CC} (V) (Note 5) | 54AC | | Units | Fig. No. |
|------------------|--------------------------------------|------------------------------------|---|------|-------|-------------|
| | | | T _A = -55°C to +125°C C _L = 50 pF | | | |
| | | | Min | Max | | |
| f _{max} | Maximum Clock Frequency | 3.3 | 75 | | MHz | |
| | | 5.0 | 90 | | | |
| t _{PLH} | Propagation Delay Clock to Output | 3.3 | 1.0 | 15.0 | ns | |
| | | 5.0 | 1.0 | 11.0 | | |
| t _{PHL} | Propagation Delay Clock to Output | 3.3 | 1.0 | 16.0 | ns | |
| | | 5.0 | 1.0 | 11.5 | | |
| t _{PHL} | Propagation Delay MR to Output | 3.3 | 1.0 | 16.0 | ns | |
| | | 5.0 | 1.0 | 11.5 | | |

Note 5: Voltage Range 3.3 is 3.3V ±0.3V. Voltage Range 5.0 is 5.0V ±0.5V

AC Operating Requirements

| Symbol | Parameter | V _{CC} (V) (Note 6) | 54AC | | Units | Fig. No. |
|------------------|---------------------------------------|------------------------------------|---|--|-------|-------------|
| | | | T _A = -55°C to +125°C C _L = 50 pF | | | |
| | | | Guaranteed Minimum | | | |
| t _s | Setup Time, HIGH or LOW Data to CP | 3.3 | 8.0 | | ns | |
| | | 5.0 | 5.0 | | | |
| t _h | Hold Time, HIGH or LOW Data to CP | 3.3 | 0 | | ns | |
| | | 5.0 | 1.0 | | | |
| t _w | Clock Pulse Width HIGH or LOW | 3.3 | 6.5 | | ns | |
| | | 5.0 | 5.0 | | | |
| t _w | MR Pulse Width HIGH or LOW | 3.3 | 10.0 | | ns | |
| | | 5.0 | 6.5 | | | |
| t _{rec} | Recovery Time MR to CP | 3.3 | 6.0 | | ns | |
| | | 5.0 | 4.0 | | | |

Note 6: Voltage Range 3.3 is 3.3V ±0.3V. Voltage Range 5.0 is 5.0V ±0.5V

Capacitance

| Symbol | Parameter | Typ | Units | Conditions |
|----------|-------------------------------|------|-------|------------------------|
| C_{IN} | Input Capacitance | 4.5 | pF | $V_{CC} = \text{Open}$ |
| C_{PD} | Power Dissipation Capacitance | 50.0 | pF | $V_{CC} = 5.0V$ |

Book
Extract
End

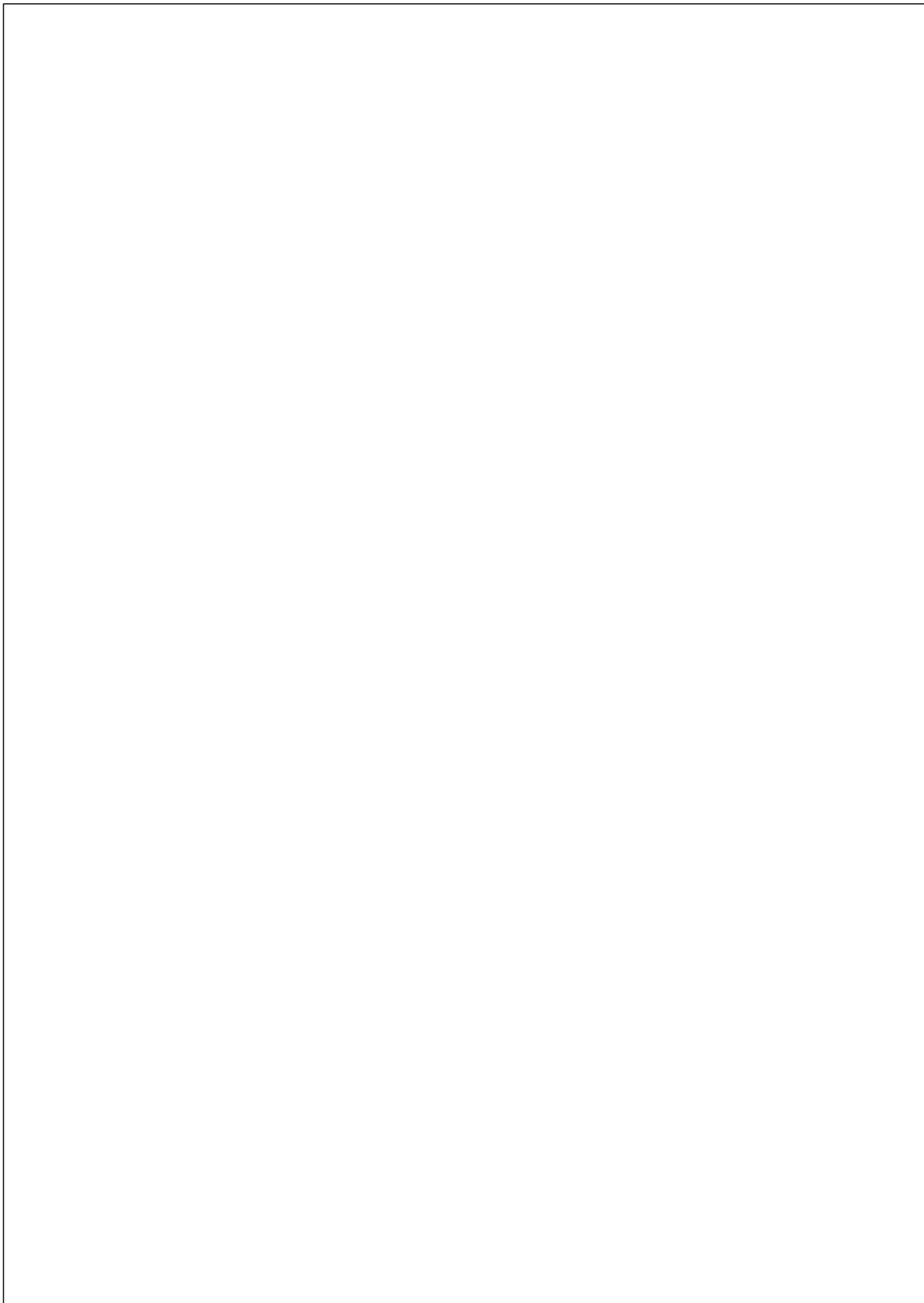

Physical Dimensions inches (millimeters) unless otherwise noted

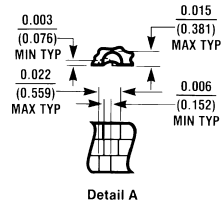
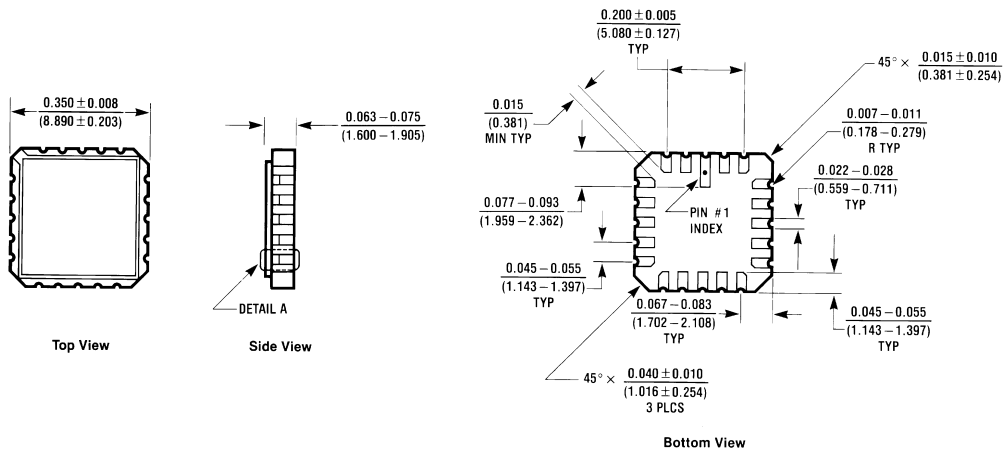

**20 Terminal Ceramic Leadless Chip Carrier (L)
NS Package Number E20A**

E20A (REV D)

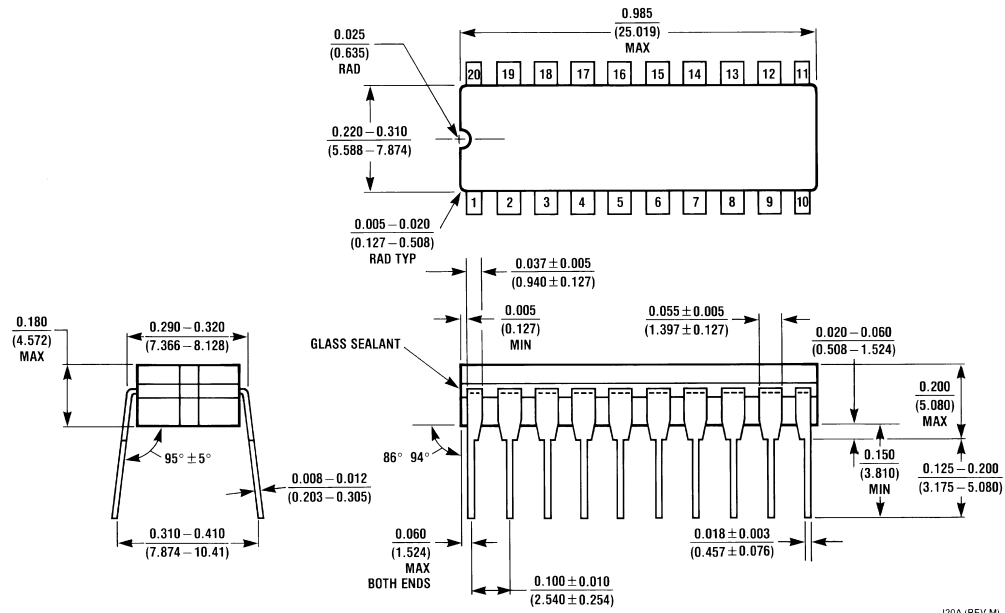

**20 Lead Ceramic Dual-In-Line Package (D)
NS Package Number J20A**

J20A (REV M)

Physical Dimensions inches (millimeters) unless otherwise noted (Continued)

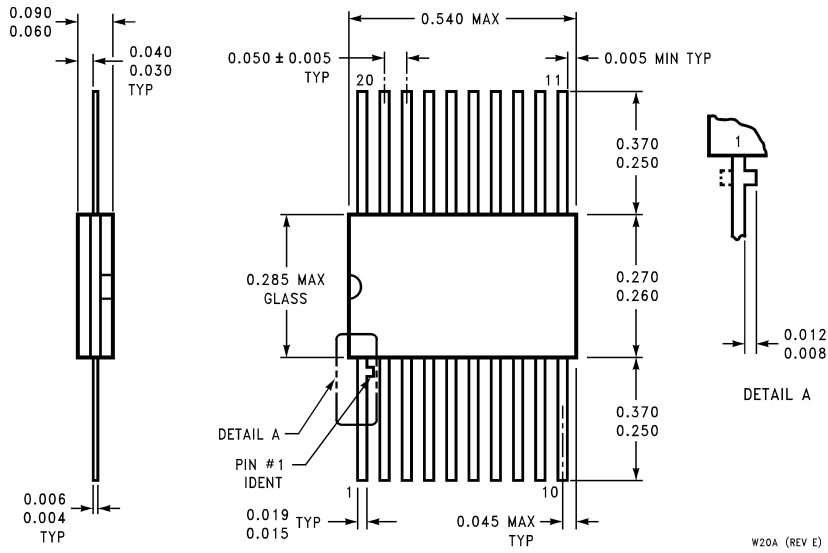

**20 Lead Ceramic Flatpak (F)
NS Package Number W20A**

LIFE SUPPORT POLICY

NATIONAL'S PRODUCTS ARE NOT AUTHORIZED FOR USE AS CRITICAL COMPONENTS IN LIFE SUPPORT DEVICES OR SYSTEMS WITHOUT THE EXPRESS WRITTEN APPROVAL OF THE PRESIDENT OF NATIONAL SEMICONDUCTOR CORPORATION. As used herein:

1. Life support devices or systems are devices or systems which, (a) are intended for surgical implant into the body, or (b) support or sustain life, and whose failure to perform when properly used in accordance with instructions for use provided in the labeling, can be reasonably expected to result in a significant injury to the user.
2. A critical component in any component of a life support device or system whose failure to perform can be reasonably expected to cause the failure of the life support device or system, or to affect its safety or effectiveness.

| | | | |
|--|---|--|---|
|  <p>National Semiconductor Corporation Americas Tel: 1-800-272-9959 Fax: 1-800-737-7018 Email: support@nsc.com</p> <p>www.national.com</p> | <p>National Semiconductor Europe Fax: +49 (0) 1 80-530 85 86 Email: europe.support@nsc.com Deutsch Tel: +49 (0) 1 80-530 85 85 English Tel: +49 (0) 1 80-532 78 32 Français Tel: +49 (0) 1 80-532 93 58 Italiano Tel: +49 (0) 1 80-534 16 80</p> | <p>National Semiconductor Asia Pacific Customer Response Group Tel: 65-2544466 Fax: 65-2504466 Email: sea.support@nsc.com</p> | <p>National Semiconductor Japan Ltd. Tel: 81-3-5620-6175 Fax: 81-3-5620-6179</p> |
|--|---|--|---|

National does not assume any responsibility for use of any circuitry described, no circuit patent licenses are implied and National reserves the right at any time without notice to change said circuitry and specifications.